

BID NUMBER PA-04412
TO: CITY OF LONG BEACH
CITY MANAGER
ATTN: CITY CLERK
333 West Ocean Boulevard, Plaza Level
Long Beach, California 90802

INVITATION TO BID
One (1) Articulated Wheel Loader
Street Surface FS1214

CONTRACT NO. 32902

- 1. COMPLETE CONTRACT:**
This Invitation to Bid, together with THE NOTICE INVITING BIDS, the entire Bid (including Specifications), or any items(s) thereof, the signature page, Instructions to Bidders, General Conditions, Special Conditions, Bid Section, Addendums, and when required, CONTRACTOR'S BOND shall become the Contract upon its acceptance by the City Manager or designee on behalf of the City of Long Beach, Contractor will be provided with a copy of the executed Contract. All materials or services provided by the Contractor shall comply with the City Charter, and all applicable Federal, State and City Laws.
- 2. SERVICES TO BE PROVIDED BY THE CONTRACTOR:**
Contractor shall upon acceptance of this Bid by the City, furnish the goods and services herein specified according to the terms and conditions set forth herein.
- 3. AMOUNT TO BE PAID:**
The City shall pay Contractor for the goods or services as described in the section entitled "PAYMENT" in the Instructions to Bidders.
- 4. CHOICE OF ALTERNATE PROVISIONS; OPTIONS; NOTIFICATION:**
When alternative provisions are requested, or options are offered, Contractor will be notified as to which provision, or option, is being accepted at the same time that he is notified that he is the successful Bidder.
- 5. DECLARATION OF NON-COLLUSION:**
The undersigned certifies or declares under penalty of perjury that this Bid is genuine and not sham or collusive, or made in the interest or on behalf of any person or entity not herein named; that the Bidder has not directly or indirectly induced or solicited any other Bidder to submit a sham bid, or any other person or entity to refrain from bidding, and that the Bidder has not in any manner sought by collusion to secure to himself any advantage over other Bidders.

BIDDER MUST COMPLETE AND SIGN BELOW:

(Signature of Corporate Officers or persons authorized to sign bids and contracts on behalf of the Contractor – refer to page 2 Instructions Concerning Signatures.)

EXECUTED AT: Corona Ca ON THE 20 DAY OF August, 20 12
CITY STATE MONTH

COMPANY NAME: Volvo Construction Equipment and Service TIN: [REDACTED]
(FEDERAL TAX IDENTIFICATION NUMBER)

STREET ADDRESS: 22099 Knabe Rd CITY: Corona STATE: Ca ZIP: 92883

PHONE: 909-322-6480 FAX: 866-741-5696

S/ <u>[Signature]</u> (SIGNATURE)	Sales Representative (TITLE)
<u>Rob Yungen</u> (PRINT NAME)	<u>Robert.Yungen@vces.volvo.com</u> (EMAIL ADDRESS)
S/ <u>[Signature]</u> (SIGNATURE)	<u>[Signature]</u> (TITLE)
<u>Phil Rasmussen</u> (PRINT NAME)	<u>[REDACTED]</u> (EMAIL ADDRESS)

ALL SIGNATURES MUST BE NOTARIZED FOR ALL COMPANIES LOCATED OUTSIDE THE STATE OF CALIFORNIA.
NO OUT-OF-STATE BID WILL BE CONSIDERED UNLESS A NOTARIAL ACKNOWLEDGMENT IS ATTACHED.
NOTARIES ARE NOT REQUIRED FOR CALIFORNIA BIDDERS.

IN WITNESS WHEREOF the City of Long Beach has caused this contract to be executed as required by law as of the date stated below.

THE CITY OF LONG BEACH
BY [Signature] 12/24/12
Director of Financial Management Date

APPROVED AS TO FORM 12-18, 2012
ROBERT E. SHANNON
CITY ATTORNEY
[Signature]
Deputy

BID NUMBER PA-04412

The City of Long Beach is committed to provide maximum opportunities for Disadvantaged, Minority, Women and Long Beach Business Enterprises (DBEs, MBEs, WBEs and Local) to compete successfully in supplying our needs for products and services.

The following information is submitted regarding the Bidder:

Legal Form of Bidder:

Corporation State of California
Partnership State of _____
 General Limited
Joint Venture
Individual DBA _____
Limited Liability Company State of _____

Composition of Ownership (more than 51% of ownership of the organization): **OPTIONAL**

Ethnic (Check one):

Black Asian Other Non-white
Hispanic American Indian Caucasian

Non-ethnic Factors of Ownership (check all that apply):

Male Yes - Physically Challenged Under 65
Female No - Physically Challenged Over 65

Is the firm certified as a Disadvantaged Business: Yes No

Has firm previously been certified as a minority-owned and/or woman-owned business enterprise by any other agency?

Yes No

Name of certifying agency: _____

INSTRUCTIONS CONCERNING SIGNATURES

Please use the proper notary form, which applies to your type of organization on all Bid documents, attachments and bonds requiring a signature by officers of your company.

NOTE: FAILURE TO COMPLY MAY RESULT IN DISQUALIFICATION OF YOUR BID.

INDIVIDUAL (Doing Business As)

- a. The only acceptable signature is the owner of the company. (Only one signature is required.)
- b. The owner's signature must be notarized if the company is located outside of the state of California.

PARTNERSHIP

- a. The only acceptable signature(s) is/are that of the general partner or partners.
- b. Signature(s) must be notarized if the partnership is located outside of the state of California.

CORPORATION

- a. Two (2) officers of the corporation must sign.
- b. Each signature must be notarized if the corporation is located outside of the state of California.

OR

- a. The signature of one officer or the signature of person other than an officer is acceptable if the Bid is accompanied by a certified corporate resolution granting authority to said person to execute contracts on behalf of the corporation.
- b. Signature(s) must be notarized if the corporation is located outside of the state of California.

LIMITED LIABILITY COMPANY

- a. The signature on the Bid must be a member or, if the Articles provide for a manager, must be the manager. (Only one signature is required.)
- b. Signature must be notarized if the company is located outside of the state of California.

THIS INFORMATION IS AVAILABLE IN AN ALTERNATIVE FORMAT BY CONTACTING 562-570-6200.

BID NUMBER PA-04412

CALIFORNIA ALL-PURPOSE ACKNOWLEDGMENT

A large, empty rectangular box with a thick black border, intended for an acknowledgment statement.

INSTRUCTIONS TO BIDDERS

1. PREPARATION OF BID:

The preparation of the Bid, including visits to the Site prior to submittal of the Bid, shall be at the expense of Bidder. All prices and notations must be typewritten or written in ink. Any markings in pencil shall not form part of the Bid and shall be disregarded by the City. Any changes or corrections in the Bid must be initialed in ink by the person signing the Bid. Bidder shall state brand name or make of each item bid. If not bidding on item as described, the manufacturer's name and catalog number of the substitute must be given. Bidder shall also attach specifications and furnish other data to establish the suitability of the substitute. Bidder shall quote separately on each item. Bidder shall quote his lowest price and best delivery date as no changes are permitted after the bid opening. Cash discounts offered for payment within fourteen (14) days or less will not be considered when evaluating bids. No telephonic, telegraphic or fax Bids are acceptable.

NOTE: ALL PAGES OF THE INVITATION TO BID MUST BE RETURNED.

2. EXAMINATION OF BID:

Bidder is responsible for examining the Invitation to Bid and submitting its Bid complete and in conformance with these instructions.

3. CONDITIONS OF WORK:

Bidder shall carefully examine the Site to become fully informed regarding all existing and expected conditions and matters, which could affect performance, cost or time of the Work.

4. DISCREPANCIES IN BID DOCUMENTS:

If Bidder finds discrepancies in or omissions from the Invitation to Bid, if the intent of the Invitation is not clear, or if provisions of the Specifications restrict Bidder from bidding, he may request in writing that the deficiency(s) be modified. Such request must be received by the City Purchasing Agent at least five (5) working days before bid opening date. Bidders will be notified by Addendum of any approved changes in the Invitation to Bid.

5. ORAL STATEMENTS:

The City of Long Beach shall not be bound by oral statements made by any employee or agent concerning this Invitation to Bid. If Bidder requires specific information, Bidder must request it in writing and obtain a reply in writing from the City.

6. BRAND NAMES AND SPECIFICATIONS:

The detailed specifications and/or brand names stated are descriptive only and indicate quality, design and construction of items required. Offers will be considered to supply articles substantially the same as those described herein but with minor variations. Bidders must describe variations in the Bid. Substitute items must be equal in quality, utility and performance. The phrase "or approved equal" throughout the specifications means that the City in its sole and absolute discretion shall make the final determination whether or not the substitute items are equal.

7. AWARD:

Bid shall be subject to acceptance by the City for a period of three (3) months unless a lesser period is prescribed in the quotation by Bidder. The City reserves the right to award all items to one Bidder, or to award separate items or groups of items to various Bidders, or to increase or decrease the quantities of any item. Bidder may submit alternate prices or name a lump sum or discount conditional on two or more items being awarded to him.

The City's purchases of goods and services are based on the City's actual needs and requirements. The City is obligated under this contract/purchase order to purchase and pay for only those goods and services that the City needs and requires, and that the City actually orders and receives. Any dollar amount identified as a "not to exceed:" amount in any City document is not a guaranteed payment amount to any contractor or service provider. Furthermore, the City may determine that its needs and requirements may be met by City labor or by a second contractor or service provider, even after an award is made to one contractor or service provider. An award is not a promise or guarantee of exclusivity.

Bidders are cautioned that comments and statements, whether oral or written, made by City employees regarding the validity of Bids, the waiver of deviations from Specifications, the possibility or probability of an award being made to a particular Bidder, and other similar matters are NOT binding on the City. Bidders should not order materials, obtain financing or take other actions based on such comments and statements. Only authorization of a Contract by the City Council or issuance of a Purchase Order is conclusive and binding on the City with respect to this Bid and its resulting Contract or Purchase Order. However, prior to authorization by the City Council or issuance of the Purchase Order, Bidders may rely on: (1) approval of an "equal" or "substitute" item which will be issued in writing, and (2) written notice of intent to award by the City Council, which is often issued prior to the authorization by the City Council so that a Bidder can order materials that have a long lead time.

8. PAYMENT:

Payment terms are NET/30 unless Bidder otherwise quotes. All Cash Discounts shall be taken and computed from the date of delivery or completion and acceptance of the material, or from date of receipt of invoice, whichever occurs last. Invoices must be submitted as specified at the time of shipping authorization. Partial payments may be made by the City on delivery & acceptance of goods and on receipt of goods and on receipt of Contractor's invoice.

In the event the Contract to be awarded hereunder, including specifications and other documents incorporated therein by reference, provides for the withholding of moneys by the City to ensure performance of such Contract, Contractor may deposit with the City, as a substitute for said withheld moneys, securities listed in Section 16430 of the California Government Code or bank or savings and loan certificates of deposit, or both, equivalent to the amount withheld, provided Contractor requests permission to make such substitution and bears all expenses in connection therewith.

9. SAFETY APPROVAL:

Where required by City Regulations, any items delivered must carry Underwriters Laboratories Approval or City of Long Beach City Safety Officer approval. Failure to so comply will be cause to reject Bid. Also, any equipment must conform with the Safety Orders of the California Division of Industrial Safety and OSHA regulations.

10. BUSINESS LICENSE:

The Long Beach Municipal Code (LBMC) requires all businesses operating in the City of Long Beach to pay a business license tax. In some cases the City may require a regulatory permit and/or evidence of a State or Federal license. Prior to issuing a business license, certain business types will require the business license application and/or business location to be reviewed by the Development Services, Fire, Health, and/or Police Departments. For more information, go to www.longbeach.gov/finance/business_license.

INSTRUCTIONS TO BIDDERS

11. PUBLIC WORK AND PREVAILING WAGES:

The Contractor to whom the contract is awarded, along with its subcontractors, shall pay not less than the general prevailing rate of per diem, holiday and overtime wages established by the Department of Industrial Relations (DIR) of the State of California for the locality in which the public work is to be performed for each craft, classification or type of worker needed to execute the contract. Refer to the California DIR's website, <http://www.dir.ca.gov/dlssr> for such prevailing wages and additional information.

The Director of Public Works of the City by and on behalf of the City Council has obtained from the Director of the Department of Industrial Relations of the State of California the general prevailing rate of per diem wages and the general prevailing rate of holiday and overtime work in the locality in which the public work is to be performed for each craft, classification or type of workers needed to execute the Contract, and the same is on file with the City Engineer, 9th floor, City Hall, 333 W. Ocean Boulevard, Long Beach, California 90802. It shall be mandatory upon the Contractor to whom the Contract is awarded, and his Subcontractors to pay not less than the said prevailing rate of wages to all workers employed by Contractor or said Subcontractors in the execution of the Contract.

12. RIGHT TO REJECT:

The City reserves the right to reject at any time any or all Bids, or parts thereof, and to waive any variances, technicalities and informalities which do not impair the quality, utility, durability or performance of the items.

13. SAMPLES:

Samples of items when requested or required must be furnished to the City free of expense to the City and, if not destroyed by tests, will upon request be returned at Bidder's expense.

14. PRICES:

Prices shall be in accordance with those extended to other governmental agencies. In case of error in extension of prices, unit price will govern. All prices must be firm for the Contract term unless the City specifically provides for adjustment.

15. CITY'S POLICY FOR MINORITY AND WOMEN-OWNED BUSINESSES:

The City of Long Beach is committed to providing maximum opportunities for Disadvantaged, Minority, Women and Long Beach Business Enterprises (DBEs, MBEs, WBEs and Local) to compete successfully in supplying our needs for products and services.

Please visit <http://www.longbeach.gov/purchasing/diversity.asp> for more information on the City's Diversity Outreach Program.

SUBCONTRACTORS

To assist the City in maintaining records of its Minority and Women Outreach Program, Bidder is requested to provide the following information. Answers are optional, and failure to answer will not disqualify Bid. If additional space is required, Bidder shall attach a separate sheet.

The following Minority- or Woman-owned subcontractors are to be utilized to provide equipment, material, supplies and/or services for this Contract requirement:

Company Name: N/A

Address: _____

Commodity/Service Provided: _____
Circle appropriate designation: MBE WBE

Ethnic Factors of Ownership: (more than 51%)
Black () American Indian ()
Hispanic () Other Non-white ()
Asian () Caucasian ()

Certified by: _____

Valid thru: _____

Dollar value of participation: \$ _____

16. BID SUBMITTAL AND WITHDRAWAL OF BIDS:

Each Bid must be delivered to the location and received on or before the due date and time stated herein. Bids will not be accepted after the date and time stated herein. Bids may be withdrawn without prejudice providing the written request is received by the City Clerk no later than the time set for opening Bids. Withdrawals will be returned to Bidder unopened.

SUBMIT TO:
CITY OF LONG BEACH
CITY CLERK
333 W OCEAN BLVD/PLAZA LEVEL
LONG BEACH CA 90802

BID DUE DATE: AUGUST 29, 2012

TIME: 11:00 am

IF BIDDER HAS ANY QUESTIONS REGARDING THIS INVITATION TO BID PLEASE CONTACT THE FOLLOWING CITY PERSONNEL.

A. COMMERCIAL (TERMS AND CONDITIONS, ETC)

MICHELLE KING 562-570-6200
BUYER TELEPHONE NUMBER

B. TECHNICAL (SPECIFICATIONS, DRAWINGS, ETC.)

ROLLIE HARVEY 562-570-5404
DEPARTMENT CONTACT TELEPHONE NUMBER

17. BID OPENING PROCEDURES:

All Bids will be publicly opened and read at the date and time specified in Instructions to Bidders, item 15.

It is our policy **not** to release price information on these Bids until the department has reviewed them and award has been approved by the City Council and the City Attorney. At that time, the information becomes public. You are welcome to review the results at that time by calling the buyer that handled that Bid and setting up an appointment. Due to the large volume of Bids received, Bid results will **not** be given out by phone and information will not be faxed.

After the Purchasing Division has analyzed the Bids, the name of the apparent low Bidder will be posted on the Internet for a period of one (1) month, together with the rankings of the top three Bidders. These rankings will not contain price information.

CAUTION: Only the City Council has authority to make an award, and a contract is not in effect until the City Council makes an award and contract documents (including insurance and bonds) are signed, submitted and approved.

Bid protest procedures may be obtained from the Buyer. Protests must be submitted within seven (7) calendar days after the date of the Bid opening.

INSTRUCTIONS TO BIDDERS

18. INTER-AGENCY PARTICIPATION:

IF OTHER AGENCIES EXPRESS AN INTEREST IN PARTICIPATING IN THIS BID, WOULD YOU SUPPLY THE SAME ITEMS.

YES X NO

(If yes, any agency electing to participate in this Bid will order its own requirements without regard to the City of Long Beach. The City of Long Beach assumes no liability or payment guarantee on any units sold to participating agencies.)

19. AMERICANS WITH DISABILITIES ACT:

Contractor shall have and be allocated the sole responsibility to comply with the Americans with Disabilities Act of 1990 ("ADA") with respect to performance hereunder and contractor shall defend, indemnify and hold the City, its officials and employees harmless from and against any and all claims of failure to comply with or violation of the ADA as said claim relates to this Contract.

20. EQUAL BENEFITS ORDINANCE:

Bidders/Proposers are advised that any contract awarded pursuant to this procurement process shall be subject to the applicable provisions of Long Beach Municipal Code section 2.73 et seq., the Equal Benefits Ordinance. Bidders/Proposers shall refer to Attachment/Appendix for further information regarding the requirements of the Ordinance.

All Bidders/Proposers shall complete and return, with their bid/proposal, the Equal Benefits Ordinance Compliance form contained in the Attachment/Appendix. Unless otherwise specified in this procurement package, Bidders/Proposers do not need to submit supporting documentation verifying with their bids/proposals. However, supporting documentation verifying that the benefits are provided equally shall be required if the Bidder/Proposer that is selected for award of a contract.

21. PERMITS, LICENSES, AND CERTIFICATES

The Contractor shall conduct all aspects of its operation in compliance with all state and federal laws and regulations.

The Contractor shall provide the City with proof of compliance with all applicable permitting (including building and public right of way permits) and licensing laws, including but not limited to, copies of all permits and licenses. The Contractor shall maintain in good standing all applicable licenses and permits related to the manufacture and delivery of bid items and related supplies and services and shall immediately notify the City of any change in the status, or the terms or conditions, of any permit or license thereof.

The Contractor shall immediately inform the City of any investigation, citation or legal action by any state, regional or federal regulatory agency in any way related to the storage, collection, composting, re-use, transfer, or disposal of any green waste, and further, shall defend, indemnify and hold harmless the City, its officials and employees from any claim demand, liability, damage, cause of action, or loss, including but not limited to attorney's fees, court costs, fines, penalties and corrective measures, that the City may sustain by reason of the Contractor's failure or alleged failure to comply with any state, regional, or federal law or regulation.

The Contractor shall be responsible for the proper disposal of all by-products, remainder and waste resulting from its services, including, but not limited to, proper storage, handling, transportation, and final disposal at a properly licensed facility.

CONTRACT – GENERAL CONDITIONS

1. Acceptance of the offer contained in this Contract is expressly limited to the terms and conditions of such offer as herein stated.
2. No charges for taxes, transportation, boxing, packaging, crating or returnable containers will be allowed and paid by the City unless separately stated hereon. All sales, use, excise or similar taxes to be paid by the City must be itemized separately hereon and on invoices. The City is exempt from payment of Federal Excise Tax under Certificate No. 95-73 0502K and none shall be charged to the City.
3. The City's obligation to pay the sum herein stated for any one fiscal year shall be contingent upon the City Council of the City appropriating the necessary funds for such payment by the City in each fiscal year during the term of this Contract. For the purposes of this section a fiscal year commences on October 1 of the year and continues through September 30 of the following year. In the event that the City Council of the City fails to appropriate the necessary funds for any fiscal year, then, and in that event, the Contract will terminate at no additional cost or obligation to the City.
4. Contractor shall deliver the materials, equipment, supplies or services, or cause the work to be performed, within the time and in the manner specified in the Contract. Times and dates stated herein are of the essence. If at any time Contractor has reason to believe that deliveries will not be made as scheduled, written notice setting forth the cause of the anticipated delay shall be given immediately to the City. Deliveries must be prepaid. C.O.D. shipments will not be accepted.
5. The City reserves the right at any time to make changes in drawings and specifications, in methods of shipment and packaging and in place of delivery as to any articles covered by this Contract. In such event there will be made an equitable adjustment in price and time of performance mutually satisfactory to Contractor and the City; but any claim by Contractor for such an adjustment must be made within thirty (30) days of such change.
6. Contractor warrants that the goods, machinery or equipment delivered or the work performed hereunder shall conform to the specifications, drawings, samples or other description specified by the City and shall be fit and sufficient for the purpose intended, merchantable, of good material and workmanship, in good working order and free from defect or faulty workmanship for a period of ninety (90) days. When defective goods, machinery, or equipment or faulty workmanship is discovered which requires repair or replacement pursuant to this warranty, Contractor shall provide all labor, materials, parts and equipment to correct such defect at no expense to the City.
7. Contractor shall defend, indemnify and hold the City, its officials and employees harmless from any and all loss, damage, liability, demands, claims, causes of action, costs and expenses (including reasonable attorney' fees) for injuries to persons (including death) or damage or destruction of property connected with or arising from the negligent acts or omissions of Contractor, its officers, agents and employees in the performance of this Contract.
8. The City reserves the right to terminate this Contract at any time in whole or in part even though Contractor is not in default hereunder. In such event there will be made an equitable adjustment of the terms that is mutually satisfactory to the City and Contractor. Upon receipt of any notice of such termination, Contractor shall, unless such notice otherwise directs, immediately discontinue all work on the Contract and deliver, if and as directed, to the City all completed and partially completed articles, work in process and materials purchased or acquired for performance of the Contract. The provisions of this section shall not limit or affect the right of the City to terminate this Contract immediately upon written notice of breach.
9. The City reserves the right to cancel this Contract or any part thereof and reject delivery of goods if delivery is not undertaken and completed when specified and in accordance with specifications. Contractor shall be charged for any direct losses, but not any consequential damages, sustained by the City by reason of such delay or failure, excepting losses caused by a delay for reasons beyond Contractor's reasonable control. Direct losses shall include any costs to the city in excess of the Contract price of obtaining goods from other sources similar to those cancelled or rejected hereunder.
10. The City shall pay to Contractor the price(s) specified in the Contract on delivery of the materials, equipment, supplies or services and acceptance thereof by the City Manager or his designee, or upon completion of the work to be performed and accepted thereof, as specified in the Contract. Defective articles or articles not in accordance with the City's specifications shall be held for Contractor's instructions at Contractor's risk, and if Contractor so directs will be returned at Contractor's expense.
11. No return or exchange of material, equipment or supplies shall be permitted without written approval of the City Purchasing Agent.
12. All royalties for patents, or changes for the use of patents, which may be involved in any article to be furnished under this Contract shall be included in the Contract price.
13. In cases where a price subject to escalation has been agreed upon, the price escalation shall be shown as a separate item on the invoice. Unless an escalator clause has been shown as a specific part of this Contract Contractor shall not be entitled to reimbursement for costs incurred due to escalation.

14. All materials, supplies and equipment provided under this Contract shall be in full compliance with the Safety Orders and Regulations of the Division of Industrial Safety of the State of California, Title 8, California Code of Regulations (CAL/OSHA) and all applicable OSHA regulations as well as all other applicable California Code of Regulations. Contractor shall indemnify and hold the City, its officials, and employees harmless for, of and from any and all loss, including but not limited to fines, penalties and corrective measures, the City may sustain by reason of Contractor's failure to comply with said laws, rules and regulations in connection with the performance of this Contract.
15. Contractor shall keep confidential and not disclose to others or use in any way to the detriment of the City confidential business or technical information that the City may disclose in conjunction with this Contract or Contractor may learn as a result of performing this Contract.
16. This Contract shall not be assigned in whole or in part, nor any duties delegated without the City's prior written approval.
17. The remedies herein reserved shall be cumulative and additional to any other remedies at law or in equity. The waiver of any breach of this Contract shall not be held to be a waiver of any other or subsequent breach. The City's failure to object to provisions contained in any communication from Contractor shall not be deemed an acceptance of such provisions or a waiver of the provisions of this Contract.
18. This Contract shall not be amended or modified, except by written agreement signed by the parties and expressly referring to this Contract.
19. Contractor shall indemnify, hold harmless and defend the City, its officials and employees from any damage, claim, loss, cost, liability, cause of action or expense, including reasonable attorney's fees, whether or not reduced to judgment, arising from any infringement or claimed infringement of any patent, trademark or copyright, or misappropriation of confidential information or trade secrets of any third party and based on the manufacture, sale or use of goods, machinery or equipment supplied hereunder.
20. Contractor shall furnish further itemization and breakdown of the Contract price when requested by the City.
21. Contractor, in the performance of any work or the furnishing of any labor under this Contract, shall be considered as an independent contractor. Contractor, his agents and employees shall not be considered as employees of the City.
22. Contractor and subcontractor(s) shall not discriminate against any person in the performance of this Contract and shall comply with applicable federal, state and city equal employment opportunity laws, ordinances, rules and regulations. Contractor and subcontractor(s) shall not discriminate against any employee or applicant for employment or against any subcontractor on the basis of race, color, religion, national origin, sex, sexual orientation, AIDS, HIV status, age, disability, or handicap, subject to federal and state laws, rules and regulations.
23. Contractor shall comply with all applicable federal, state and local laws pertaining to the subject matter hereof.
24. Contractor shall submit samples of all documents that Contractor may require the City to execute to complete this transaction. By accepting these samples as part of the bid or by awarding the Contract to a Contractor who has submitted said samples, the City does not agree to the terms stated in said samples. This Invitation to Bid and Contractor's bid shall take priority over said samples and this Invitation and Contractor's bid shall become the Contract between the City and the Contractor.
25. All quantities stated herein are only ESTIMATES. The City reserves the right to increase or decrease these estimated quantities based on its actual needs and funds available.
26. The City reserves the right to exercise, at its option, an increase in expenditures by ten (10) percent annually, but the City does not guarantee such an increase.
27. Contractor shall cooperate with the City in all matters relating to taxation and the collection of taxes, particularly with respect to the self-accrual of use tax. Contractor shall cooperate as follows: (i) for all leases and purchases of materials, equipment, supplies or other tangible personal property totaling over \$100,000 shipped from outside California, a qualified Contractor shall complete and submit to the appropriate governmental entity the form in Appendix "A" attached hereto; and (ii) for construction contracts and subcontracts totaling \$5,000,000 or more, Contractor shall obtain a sub-permit from the California Board of Equalization for the Work site. "Qualified"

means that the Contractor purchased at least \$500,000 in tangible personal property that was subject to sales or use tax in the previous calendar year.

In completing the form and obtaining the permit(s), Contractor shall use the address of the Work site as its business address and may use any address for its mailing address. Copies of the form and permit(s) shall also be delivered to the Purchasing Agent. The form must be submitted and the permit(s) obtained as soon as Contractor receives a notice of award. Contractor shall not order any materials or equipment over \$100,000 from vendors outside California until the form is submitted and the permit(s) obtained and, if Contractor does so, it shall be a material breach of the Agreement. In addition, Contractor shall make all purchases from its Long Beach sales office and the Long Beach sales office of its vendors if those vendors have a Long Beach office and all purchases made by Contractor under this Agreement which are subject to use tax of \$500,000 or more shall be allocated to the City of Long Beach. Contractor shall require the same form and permit(s) from its subcontractors.

Contractor shall not be entitled to and by signing this Contract waives any claim or damages for delay against City if Contractor does not timely submit these forms to the appropriate governmental entity. Contractor may contact Rosie Bouquin at 562-570-7079 for assistance with the form.

28. The California Integrated Waste Management Act (Public Resources Code, Sec. 40000 et seq.) requires governmental entities to achieve fifty (50) percent diversion of waste. In conjunction with the City's Integrated Resources Bureau, the City is currently developing an Environmentally Preferable Product (EPP) procurement plan. These guidelines enable the City Purchasing Agent to greatly expand procurement programs by moving beyond a singular consideration of "recycled-content". EPP procurement facilitates the purchase of products that qualify within a broad range of "environmentally preferable" criteria, such as: minimal packaging; energy savings; non-toxic; manufactured from sustainably-harvested materials. Contractor shall monitor products that fall within the EPP guidelines and document all criteria that qualifies the product as an EPP. Documentation from the manufacturer will be acceptable and may be required during the term of the Contract.
29. NOTICE TO BIDDERS REGARDING THE PUBLIC RECORDS ACT:
Responses to this Invitation to Bid become the exclusive property of the City of Long Beach. All Bids submitted in response to this Invitation to Bid are a matter of public record and shall be regarded as public records. Exceptions will be only those elements in each Bid that are defined by the Bidder as business or trade secrets and are marked as "Trade Secrets", "Confidential" or "Proprietary".

The City shall not be liable or responsible in any way for disclosure of any records not marked as "Trade Secrets", "Confidential" or "Proprietary". The City shall not be liable or responsible in any way for disclosure of any records so marked if disclosure is deemed to be required by law or by a court order.

30. THE FOLLOWING ADDITIONAL CONDITIONS APPLY ONLY IN CASES WHERE CONTRACTOR IS TO PERFORM WORK ON CITY PROPERTY:
- A. If at any time during the progress of the Work, Contractor shall allow any indebtedness to accrue for labor, equipment or materials, or which may become a claim against the City, Contractor shall immediately upon request from the City pay such claim or indebtedness or cause such lien to be dissolved and discharged by giving a bond or otherwise and, in case of his failure so to do, the City may withhold any money due Contractor until such claim or indebtedness is paid or may apply such money toward the discharge thereof; or in such event the City may, at its option, declare this Contract to be terminated, take possession and control of the Work, and complete the same or cause the same to be completed according to the specifications. Contractor shall pay to the City the difference between the Contract price and the actual cost to the City in completing or causing the Work to be completed.
- B. Contractor shall carry on the Work at its own risk until the same is fully completed and accepted and shall, in case of any accident, destruction or injury to the Work or materials before its final completion and acceptance, repair or replace the Work or materials so injured, damaged and destroyed, at his own expense and to the satisfaction of the City. When materials and equipment are furnished by others for installation or erection by Contractor, Contractor shall receive, unload, store and handle same at the Site and become responsible therefore as though such materials and equipment were being furnished by Contractor under the Contract.
- C. Contractor shall procure and maintain at Contractor's expense for the duration of the Contract the following insurance against claims for injuries to persons or damage to property which may arise from or in connection

with the performance of the Contract by Contractor, its agents, representatives, employees or subcontractors:

- (1) Comprehensive General Liability: \$1,000,000 combined single limit for each occurrence or \$2,000,000 General Aggregate for bodily injury, personal injury and property damage, including products and completed operations coverage.

The City, its officials, employees and agents shall be named as additional insureds as respects: liability arising out of activities performed by or on behalf of Contractor; products and completed operations of Contractor; and premises owned, leased or used by Contractor.

- (2) Automobile Liability: \$500,000 combined single limit per accident for bodily injury and property damage covering owned, non-owned and hired vehicles.
- (3) Workers' Compensation as required by the California Labor Code and Employers Liability limits of \$1,000,000 per accident.

Any self-insurance program and self-insured retention must be separately approved in writing by the City.

Each insurance policy shall be endorsed to state that coverage shall not be cancelled by either party or reduced in coverage except after thirty (30) days prior written notice to the City.

Contractor shall maintain at its expense, until completion of performance and acceptance by City, from an insurer:

- a. Admitted (licensed) in the State of California with a current financial responsibility rating of A (Excellent) or better and a current financial size category (FSC) of V (capital surplus and conditional surplus funds of greater than \$10 million) or greater rating as reported by A.M. Best Company or equivalent, unless waived in writing by City's Risk Manager, or
- b. Non-admitted in the State of California with a current financial responsibility rating of A (Excellent) or better and a current financial size category (FSC) of VIII (capital surplus and conditional surplus funds of greater than \$100 million) or greater rating as reported by A.M. Best Company or equivalent, unless waived in writing by City's Risk Manager.

All coverages for Subcontractors shall be subject to the requirements stated herein and shall be maintained at no expense to the City.

Contractor shall furnish the City with certificates of insurance and original endorsements providing coverage as required above. The certificates and endorsements for each insurance policy are to be signed by a person authorized by that insurer to bind coverage on its behalf.

Before any of Contractor's or Subcontractor's employees shall do any Work on the City's property, Contractor shall furnish the City with the required certificates evidencing that such insurance is being maintained. Such certificates shall specify the date when such insurance expires. Such insurance shall be maintained until after the Work under the Contract has been completed and accepted.

Such insurance as required herein or in any other documents to be considered a part hereof shall not be deemed to limit Contractor's liability under this Contract.

- D. Contractor shall defend, indemnify and hold harmless the City, its officials and employees from and against any and all liability for claims for bodily injury and property damage arising out of negligent acts, omissions or errors of any employee of Contractor at the Site.
- E. Contractor shall list the name and location of the place of business of each Subcontractor who will perform work, labor or services for Contractor, or who specially fabricates and installs a portion of the Work or improvement in an amount in excess of one-half of one percent of Contractor's total contract cost. The Subcontractor list shall be submitted with Contractor's Bid.

**PA-04412
ARTICULATED WHEEL LOADER
STREET SURFACE FS1214**

	YES	NO	COMMENTS/EXCEPTIONS
<p><u>Instructions:</u></p> <p>State comments and or exceptions in the blank spaces provided in each section regarding the vehicle or equipment offered corresponding to the specifications set forth. FAILURE TO COMPLETE ALL BLANK SPACES WILL OTHERWISE BE DETERMINED AS VENDOR MEETING SPECIFICATIONS MINIMUMS.</p>	Yes		As Specified
<p><u>General:</u></p> <p>Purchase of one (1) articulated wheel loader, with, ROPS/FOPS, rubber tired, four (4) wheel drive, and a diesel engine. The design of the tractor must embody the latest approved automotive industrial engineering practices and the workmanship must be of the highest quality in its respective field. The tractor shall be completely equipped as specified and be ready for service upon delivery. The unit(s) shall comply with the latest applicable editions of the California Code and the California Code of Regulations, SAE Standards, Federal Motor Vehicle Safety Standards and Provisions of Cal OSHA. The omission from the specifications of any standard feature as shown in manufacturer's brochure shall not alleviate the successful Contractor from the responsibility of furnishing a complete tractor with all of the manufacturer's latest improvements in current production unless specifically deleted in the specifications. The tractor and all components shall be standard production items unless other wise specified.</p>	Yes		As Specified
<p><u>Operating Weight:</u></p> <p>Minimum SAE 19,300, exclusive of tire, ballast, and equipment specified.</p>	Yes		As Specified

**PA-04412
ARTICULATED WHEEL LOADER
STREET SURFACE FS1214**

	YES	NO	COMMENTS/EXCEPTIONS
<p><u>Wheelbase:</u></p> <p>Shall be at least 108 inches.</p>		No	104"
<p><u>Engine:</u></p> <ol style="list-style-type: none"> 1. Minimum inline 4 cylinder diesel U.S.EPA Tier 4 interim 2. Minimum net SAE HP 90 3. Turbo aspirated 4. Direct fuel injection 5. Primary fuel filter with water and sediment separator 6. Spin on full flow oil filter 7. Hand and foot throttle control 8. Dry air filter, with pre cleaner <p>CARB approved diesel particulate filter</p>	Yes		As Specified to All
<p><u>Engine Cooling:</u></p> <ol style="list-style-type: none"> 1. Engine shall be protected to -34 degrees with extended life coolant. 2. The radiator shall be protected against flying debris. 3. The water pump shall be integral to the engine block 4. The cooling fan shall be enshrouded to insure air flow, and protect against human contact 	Yes		As Specified to All

**PA-04412
ARTICULATED WHEEL LOADER
STREET SURFACE FS1214**

	YES	NO	COMMENTS/EXCEPTIONS
<p><u>Electrical:</u></p> <ol style="list-style-type: none"> 1. Shall be 24V, with a disconnect switch 2. Back-up alarm, electric, complying with Cal OSHA requirements 3. Shall be a 24V starting system 4. Shall have legal road lights 5. Shall have engine and transmission gauges installed in control console area in operators line of sight. 6. Shall have ignition switch installed on control console. 	Yes		As Specified to All
<p><u>Transmission / Power train:</u></p> <ol style="list-style-type: none"> 1. Transmission shall be an automatic shift type. 2. Transmission, and differential shall have separate fluid reservoirs 3. Transmission shall have minimum 4 forward gears, and two reverse gears, and a fully synchronized power shuttle. 4. Transmission shall have a spin on oil filter <p>Unit shall have a minimum level ground high gear speed of 22 MPH</p>	Yes Yes Yes	 No	 3 Forward 3 Reverse
<p><u>Steering:</u></p> <ol style="list-style-type: none"> 1. Oscillation shall be no less than 40 degrees each side direction from centerline. 2. Center pivot dual steering cylinders shall be double acting 	Yes		As Specified to All
<p><u>Differentials:</u></p> <ol style="list-style-type: none"> 1. Front, and rear shall be conventional. 	Yes		As Specified to All
<p><u>Axle Front:</u></p> <ol style="list-style-type: none"> 1. Shall be planetary gear reduction design. 	Yes		As Specified to All

**PA-04412
ARTICULATED WHEEL LOADER
STREET SURFACE FS1214**

	YES	NO	COMMENTS/EXCEPTIONS
<u>Axle Rear:</u>			
1. Shall be planetary gear reduction design.	Yes		As Specified
<u>Hydraulic System:</u>			
1. Complete system shall be compatible with loader and accessories furnished, and shall be adequate size and capacity, including filters, pump gpm, hoses, lines, valves, and relief valves, to properly operate and maintain the loader in continuous service. 2. Shall have a variable displacement pump. 3. Third function hydraulic circuit.	Yes		As Specified to All
<u>Controls:</u>			
1. All hydraulic controls shall be joystick type or approved equal, and shall be easily accessible to the operator, when seated in the <u>working</u> position.	Yes		As Specified to All
<u>Loader:</u>			
1. Loader shall have heavy-duty, self leveling, 2.25 yd ³ bucket, with level indicator, and a return-to-dig feature with single lever control. 2. Loader bucket shall have "bolt-on" cutting edge of Kenco hardened steel, or approved equal, and high spill guards. 3. Minimum hinge pin maximum height shall be 140"	Yes		As Specified to All 88" 1.5Yd General Purpose Bucket included in Bid Price Quick Coupler Included ASC 1000 or Volvo Quick Coupler The Cities Preference
<u>Brakes:</u>			
System shall meet OSHA regulations, shall be individually <u>or</u> simultaneously foot operated discs. Wet type hydraulically operated disc brakes, with mechanical hand or foot operated parking brake complying with SAE recommended practice J-237.	Yes		As Specified To All

**PA-04412
ARTICULATED WHEEL LOADER
STREET SURFACE FS1214**

	YES	NO	COMMENTS/EXCEPTIONS
<p><u>Counter weights:</u></p> <p>1. At least manufacturer's suggested minimum on front/rear of tractor. If more or less weights are required to "balance loader, they shall be added or deleted.</p> <p><u>Balance</u> of tractor to be determined <u>after</u> unit is put in service.</p>	Yes		As Specified
<p><u>Cab:</u></p> <p>1. Shall be an enclosed cab design.</p> <p>2. <u>ROPS/FOPS:</u></p> <p>3. Dual cab doors.</p> <p>4. Shall have heating, air conditioning, and defroster.</p> <p>5. Shall have sliding glass door windows.</p> <p>6. Radio, and CD.</p> <p>7. Adjustable tilt steering.</p> <p>8. Complete instrument gauges, to include; engine RPM, hydraulic oil temperature, engine coolant temperature, transmission temperature, fuel level, speedometer, hour, and odometer.</p> <p>9. Shall have indicator control lights to include; turn signal, parking brake, low brake pressure, oil temperature lights, and electrical system warning.</p> <p>10. Seat shall be manufacturer's optional best, fabric covering, air suspension type with arm rests. It shall be adjustable fore and aft and to operator's weight.</p> <p>11. 3 in. wide seat belts.</p>	Yes		As Specified to All

**PA-04412
ARTICULATED WHEEL LOADER
STREET SURFACE FS1214**

	YES	NO	COMMENTS/EXCEPTIONS
<p><u>Service Manual:</u></p> <p>Successful bidder shall provide two full sets of operating/service manuals (hard copy) for every major component installed in equipment including cab and, electrical schematics, hydraulic schematics, and a complete parts manual. All manuals and schematics shall be delivered with each unit.</p>	Yes		As Specified
<p><u>Training:</u></p> <p>Vendor shall provide a minimum of two hours training for operators, and service personnel to familiarize themselves to the machine operations, and maintenance.</p>	Yes		As Specified
<p>Point of delivery:</p> <p>City of long Beach Public Works Department Fleet Services Bureau 2600 temple Ave. Long Beach Ca. 90806</p>	Yes		
<p><u>Acceptable Manufacturers:</u></p> <p>Case Caterpillar John Deere Volvo</p>	Yes		Volvo L45G

PA-04412
ARTICULATED WHEEL LOADER
STREET SURFACE FS1214

BID SECTION

\$ 102,152.00 COST PER UNIT
\$ 0.00 TIRE TAX
\$ Included DELIVERY
\$ 8,938.30 SALES TAX
\$ 111,090.30 TOTAL COST PER UNIT

ESTIMATED DAY OF DELIVERY 90-120 Days

PAYMENT TERMS Net 30 Days
(discounts offered)

Time is of the essence for delivery. Failure to deliver on the date stated above is a material breach of the contract. The parties agree that damages for delay would be difficult to calculate. Therefore, liquidated damages in the amount of \$ 125.00 per day will be withheld from final payment.

REFERENCES:

COMPANY NAME County of Los Angeles

CONTACT PERSON Frank Solano

PHONE # 626-468-7307 EMAIL

COMPANY NAME City of Los Angeles

CONTACT PERSON Walter Lee

PHONE # 323-526-9229 EMAIL

COMPANY NAME City of Los Angeles Department of Water and Power

CONTACT PERSON Jose Pineda

PHONE # 213-367-6706 EMAIL

COMPANY NAME Port of Los Angeles

CONTACT PERSON Brad Stewart

PHONE # 310-732-3403 EMAIL

COMPANY NAME Los Angeles County Sanitation

CONTACT PERSON David Bolderoff

PHONE # 562-699-6028 EMAIL

Request for Taxpayer Identification Number and Certification

Give form to the
requester. Do not
send to the IRS.

Print or type See Specific Instructions on page 2.	Name (as shown on your income tax return)	
	Business name, if different from above	
	Check appropriate box: <input type="checkbox"/> Individual/Sole proprietor <input type="checkbox"/> Corporation <input type="checkbox"/> Partnership <input type="checkbox"/> Limited liability company. Enter the tax classification (D=disregarded entity, C=corporation, P=partnership) ▶ <input type="checkbox"/> Exempt payee <input type="checkbox"/> Other (see instructions) ▶	
	Address (number, street, and apt. or suite no.)	Requester's name and address (optional)
	City, state, and ZIP code	
	List account number(s) here (optional)	

Part I Taxpayer Identification Number (TIN)

Enter your TIN in the appropriate box. The TIN provided must match the name given on Line 1 to avoid backup withholding. For individuals, this is your social security number (SSN). However, for a resident alien, sole proprietor, or disregarded entity, see the Part I instructions on page 3. For other entities, it is your employer identification number (EIN). If you do not have a number, see *How to get a TIN* on page 3.

Note. If the account is in more than one name, see the chart on page 4 for guidelines on whose number to enter.

Social security number	
or	
Employer identification number	

Part II Certification

Under penalties of perjury, I certify that:

- The number shown on this form is my correct taxpayer identification number (or I am waiting for a number to be issued to me), and
- I am not subject to backup withholding because: (a) I am exempt from backup withholding, or (b) I have not been notified by the Internal Revenue Service (IRS) that I am subject to backup withholding as a result of a failure to report all interest or dividends, or (c) the IRS has notified me that I am no longer subject to backup withholding, and
- I am a U.S. citizen or other U.S. person (defined below).

Certification instructions. You must cross out item 2 above if you have been notified by the IRS that you are currently subject to backup withholding because you have failed to report all interest and dividends on your tax return. For real estate transactions, item 2 does not apply. For mortgage interest paid, acquisition or abandonment of secured property, cancellation of debt, contributions to an individual retirement arrangement (IRA), and generally, payments other than interest and dividends, you are not required to sign the Certification, but you must provide your correct TIN. See the instructions on page 4.

Sign Here	Signature of U.S. person ▶	Date ▶
------------------	----------------------------	--------

General Instructions

Section references are to the Internal Revenue Code unless otherwise noted.

Purpose of Form

A person who is required to file an information return with the IRS must obtain your correct taxpayer identification number (TIN) to report, for example, income paid to you, real estate transactions, mortgage interest you paid, acquisition or abandonment of secured property, cancellation of debt, or contributions you made to an IRA.

Use Form W-9 only if you are a U.S. person (including a resident alien), to provide your correct TIN to the person requesting it (the requester) and, when applicable, to:

- Certify that the TIN you are giving is correct (or you are waiting for a number to be issued),
- Certify that you are not subject to backup withholding, or
- Claim exemption from backup withholding if you are a U.S. exempt payee. If applicable, you are also certifying that as a U.S. person, your allocable share of any partnership income from a U.S. trade or business is not subject to the withholding tax on foreign partners' share of effectively connected income.

Note. If a requester gives you a form other than Form W-9 to request your TIN, you must use the requester's form if it is substantially similar to this Form W-9.

Definition of a U.S. person. For federal tax purposes, you are considered a U.S. person if you are:

- An individual who is a U.S. citizen or U.S. resident alien,
- A partnership, corporation, company, or association created or organized in the United States or under the laws of the United States,
- An estate (other than a foreign estate), or
- A domestic trust (as defined in Regulations section 301.7701-7).

Special rules for partnerships. Partnerships that conduct a trade or business in the United States are generally required to pay a withholding tax on any foreign partners' share of income from such business. Further, in certain cases where a Form W-9 has not been received, a partnership is required to presume that a partner is a foreign person, and pay the withholding tax. Therefore, if you are a U.S. person that is a partner in a partnership conducting a trade or business in the United States, provide Form W-9 to the partnership to establish your U.S. status and avoid withholding on your share of partnership income.

The person who gives Form W-9 to the partnership for purposes of establishing its U.S. status and avoiding withholding on its allocable share of net income from the partnership conducting a trade or business in the United States is in the following cases:

- The U.S. owner of a disregarded entity and not the entity,

**CERTIFICATION OF COMPLIANCE WITH THE
EQUAL BENEFITS ORDINANCE**

Section 1. CONTRACTOR/VENDOR INFORMATION

Name: Volvo Construction Equipment Federal Tax ID No.
Address: 22099 Knabe Rd
City: Corona State: Ca ZIP: 92883
Contact Person: Rob Yungen Telephone: 909-322-6480
Email: Robert.yungen@vcesvolvo.com Fax: 866-741-5696

Section 2. COMPLIANCE QUESTIONS

- A. The EBO is inapplicable to this Contract because the Contractor/Vendor has no employees. Yes No
- B. Does your company provide (or make available at the employees' expense) any employee benefits? Yes No
(If "yes," proceed to Question C. If "no," proceed to section 5, as the EBO does not apply to you.)
- C. Does your company provide (or make available at the employees' expense) any benefits to the spouse of an employee?
 Yes No
- D. Does your company provide (or make available at the employees' expense) any benefits to the domestic partner of an employee?
 Yes No (If you answered "no" to both questions C and D, proceed to section 5, as the EBO is not applicable to this contract. If you answered "yes" to both Questions C and D, please continue to Question E. If you answered "yes" to Question C and "no" to Question D, please continue to section 3.)
- E. Are the benefits that are available to the spouse of an employee identical to the benefits that are available to the domestic partner of an employee? Yes No
(If "yes," proceed to section 4, as you are in compliance with the EBO. If "no," continue to section 3.)

Section 3. PROVISIONAL COMPLIANCE

- A. Contractor/vendor is not in compliance with the EBO now but will comply by the following date:
- By the first effective date after the first open enrollment process following the contract start date, not to exceed two years, if the

Contractor/vendor submits evidence of taking reasonable measures to comply with the EBO; or

_____ At such time that the administrative steps can be taken to incorporate nondiscrimination in benefits in the Contractor/vendor's infrastructure, not to exceed three months; or

_____ Upon expiration of the contractor's current collective bargaining agreement(s).

- B. If you have taken all reasonable measures to comply with the EBO but are unable to do so, do you agree to provide employees with a cash equivalent? (The cash equivalent is the amount of money your company pays for spousal benefits that are unavailable for domestic partners.)

_____ Yes No

Section 4. REQUIRED DOCUMENTATION

At time of issuance of purchase order or contract award, you may be required by the City to provide documentation (copy of employee handbook, eligibility statement from your plans, insurance provider statement, etc.) to verify that you do not discriminate in the provision of benefits.

Section 5. CERTIFICATION

I declare under penalty of perjury under the laws of the State of California that the foregoing is true and correct and that I am authorized to bind this entity contractually. By signing this certification, I further agree to comply with all additional obligations of the Equal Benefits Ordinance that are set forth in the Long Beach Municipal Code and in the terms of the contract of purchase order with the City.

Executed this 20 day of August, 2012, at Corona, Ca

Name Rob Yungen

Signature 

Title Sales Representative

Federal Tax ID No. ██████████

Form **W-9**
(Rev. October 2007)
Department of the Treasury
Internal Revenue Service

Request for Taxpayer Identification Number and Certification

Give form to the
requestor. Do not
send to the IRS.

Print or type
See Specific Instructions on page 2.

Name (as shown on your income tax return)
SABA Holding Company

Business name, if different from above
Volvo Construction Equipment Service

Check appropriate box: Individual/Sole proprietor Corporation Partnership
 Limited liability company. Enter the tax classification (D=disregarded entity, C=corporation, P=partnership) ▶ Exempt payee
 Other (see Instructions) ▶

Address (number, street, and apt. or suite no.)
22099 Knabe Road

City, state, and ZIP code
Corona, CA 92883

Requester's name and address (optional)

List account number(s) here (optional)

Part I Taxpayer Identification Number (TIN)

Enter your TIN in the appropriate box. The TIN provided must match the name given on Line 1 to avoid backup withholding. For individuals, this is your social security number (SSN). However, for a resident alien, sole proprietor, or disregarded entity, see the Part I Instructions on page 3. For other entities, it is your employer identification number (EIN). If you do not have a number, see *How to get a TIN* on page 3.

Note. If the account is in more than one name, see the chart on page 4 for guidelines on whose number to enter.

Social security number
OR
Employer identification number

Part II Certification

Under penalties of perjury, I certify that:

- The number shown on this form is my correct taxpayer identification number (or I am waiting for a number to be issued to me), and
- I am not subject to backup withholding because: (a) I am exempt from backup withholding, or (b) I have not been notified by the Internal Revenue Service (IRS) that I am subject to backup withholding as a result of a failure to report all interest or dividends, or (c) the IRS has notified me that I am no longer subject to backup withholding, and
- I am a U.S. citizen or other U.S. person (defined below).

Certification instructions. You must cross out item 2 above if you have been notified by the IRS that you are currently subject to backup withholding because you have failed to report all interest and dividends on your tax return. For real estate transactions, item 2 does not apply. For mortgage interest paid, acquisition or abandonment of secured property, cancellation of debt, contributions to an individual retirement arrangement (IRA), and generally, payments other than interest and dividends, you are not required to sign the Certification, but you must provide your correct TIN. See the Instructions on page 4.

Sign Here Signature of U.S. person *[Signature]* Date *1/22/10*

General Instructions

Section references are to the Internal Revenue Code unless otherwise noted.

Purpose of Form

A person who is required to file an information return with the IRS must obtain your correct taxpayer identification number (TIN) to report, for example, income paid to you, real estate transactions, mortgage interest you paid, acquisition or abandonment of secured property, cancellation of debt, or contributions you made to an IRA.

Use Form W-9 only if you are a U.S. person (including a resident alien), to provide your correct TIN to the person requesting it (the requester) and, when applicable, to:

- Certify that the TIN you are giving is correct (or you are waiting for a number to be issued),
- Certify that you are not subject to backup withholding, or
- Claim exemption from backup withholding if you are a U.S. exempt payee. If applicable, you are also certifying that as a U.S. person, your allocable share of any partnership income from a U.S. trade or business is not subject to the withholding tax on foreign partners' share of effectively connected income.

Note. If a requester gives you a form other than Form W-9 to request your TIN, you must use the requester's form if it is substantially similar to this Form W-9.

Definition of a U.S. person. For federal tax purposes, you are considered a U.S. person if you are:

- An individual who is a U.S. citizen or U.S. resident alien,
- A partnership, corporation, company, or association created or organized in the United States or under the laws of the United States,
- An estate (other than a foreign estate), or
- A domestic trust (as defined in Regulations section 301.7701-7).

Special rules for partnerships. Partnerships that conduct a trade or business in the United States are generally required to pay a withholding tax on any foreign partners' share of income from such business. Further, in certain cases where a Form W-9 has not been received, a partnership is required to presume that a partner is a foreign person, and pay the withholding tax. Therefore, if you are a U.S. person that is a partner in a partnership conducting a trade or business in the United States, provide Form W-9 to the partnership to establish your U.S. status and avoid withholding on your share of partnership income.

The person who gives Form W-9 to the partnership for purposes of establishing its U.S. status and avoiding withholding on its allocable share of net income from the partnership conducting a trade or business in the United States is in the following cases:

- The U.S. owner of a disregarded entity and not the entity,

DISPLAY CONSPICUOUSLY AT PLACE OF BUSINESS FOR WHICH ISSUED

CALIFORNIA STATE BOARD OF EQUALIZATION

SELLER'S PERMIT



ACCOUNT NUMBER

1/1/2009 SR Y OHB 101-193743 00002 EH

SABA HOLDING COMPANY
22099 KNABE RD
CORONA, CA 92883-7111

NOTICE TO PERMITTEE
You are required to obey all Federal and State laws that regulate or control your business. This permit does not allow you to do otherwise.

IS HEREBY AUTHORIZED PURSUANT TO SALES AND USE TAX LAW TO ENGAGE IN THE BUSINESS OF SELLING TANGIBLE PERSONAL PROPERTY AT THE ABOVE LOCATION. THIS PERMIT IS VALID ONLY AT THE ABOVE ADDRESS.

THIS PERMIT IS VALID UNTIL REVOKED OR CANCELED AND IS NOT TRANSFERABLE. IF YOU SELL YOUR BUSINESS OR DROP OUT OF A PARTNERSHIP, NOTIFY US OR YOU COULD BE RESPONSIBLE FOR SALES AND USE TAXES OWNED BY THE NEW OPERATOR OF THE BUSINESS.

Not valid at any other address

For general tax questions, please call our Information Center at 800-400-7115.

For information on your rights, contact the Taxpayers' Rights Advocate Office at 888-324-2798 or 916-324-2798.

BOL 442 REV 15 (2-09)

A MESSAGE TO OUR NEW PERMIT HOLDER

As a seller, you have rights and responsibilities under the Sales and Use Tax Law. In order to assist you in your endeavor and to better understand the law, we offer the following sources of help:

- Visiting our website at www.sbe.ca.gov
- Visiting a district office
- Attending a Basic Sales and Use Tax Law class offered at one of our district offices
- Sending your questions in writing to any one of our offices
- Calling our toll-free Information Center at 800-400-7115

As a seller, you have the right to issue resale certificates for merchandise that you intend to resell. Conversely, you have the responsibility of not including resale certificates. While the sales tax is imposed upon the retailer:

- You have the right to seek reimbursement of the tax from your customer.
- You are responsible for filing and paying your sales and use tax returns timely.
- You have the right to be treated in a fair and equitable manner by the employees of the Board.
- You are responsible for following the regulations set forth by the Board.

As a seller, you are expected to maintain the normal books and records of a prudent businessperson. You are required to maintain these books and records for no less than four years, and make them available for inspection by a Board representative when requested. You are also expected to notify us if you are buying, selling, adding a location, or discontinuing your business, adding or dropping a partner, officer, or member, or when you are moving any or all of your business locations. If it becomes necessary to surrender this permit, you should only do so by mailing it to a Board office, or giving it to a Board representative.

If you would like to know more about your rights as a taxpayer, or if you are unable to resolve an issue with the Board, please contact the Taxpayers' Rights Advocate Office for help by calling toll-free, 888-324-2798 or 916-324-2798. Their fax number is 916-323-3313.

Please post this permit at the address for which it was issued and at a location visible to your customers.

STATE BOARD OF EQUALIZATION
Sales and Use Tax Department

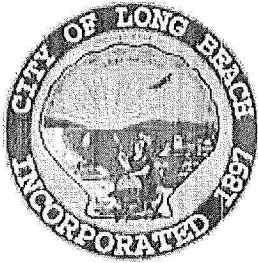

City of Long Beach

Department of Financial Management
Division of Procurement
333 W Ocean Blvd. 7th floor, Long Beach, California 90802
p 562.570.6020
Michelle.King@Longbeach.gov

August 28, 2012

NOTICE TO BIDDERS

ADDENDUM NO. 1

PA-04412

One (1) Articulated Wheel Loader Street Surface FS1214

The City of Long Beach received questions regarding this bid.

1. Question: Spec calls for a 2.25 cu yd bucket with edge.
In Accessories Items: #11 General-purpose grapple.

Answer: Please bid a 1.5 yard general purpose bucket.

2. Question: Are you asking for another bucket, grapple type? That would be a pin on type, no quick coupler specified?

Answer: Yes, we are asking for an additional bucket, 1.5 yard grapple type, with an ACS 1000 coupler system. 2.25 cu cy with grapple is getting quite heavy for a 90 hp, 19,000 lb machine.

Any additional questions must be submitted in writing to Michelle.King@longbeach.gov

Prepared By: Michelle King Date: August 28, 2012
Buyer

Acknowledged By: VOLVO CONSTRUCTION EQ
Company Name

Rob Vingen
Print Name

Sales Representative
Title

[Signature]
Signature

8-28-12
Date

VOLVO WHEEL LOADERS

L45G, L50G

8.6-9.9 t (19,026-21,804 lbs) 98-114 hp



A PASSION FOR PERFORMANCE.

At Volvo Construction Equipment, we're not just coming along for the ride. Developing products and services that raise productivity – we are confident we can lower costs and increase profits for industry experts. Part of the Volvo Group, we are passionate about innovative solutions to help you work smarter – not harder.

Helping you to do more

Doing more with less is a trademark of Volvo Construction Equipment. High productivity has long been married to low energy consumption, ease of use and durability. When it comes to lowering life-cycle costs, Volvo is in a class of its own.

Designed to fit your needs

There is a lot riding on creating solutions that are suited to the particular needs of different industry applications. Innovation often involves high technology – but it doesn't always have to. Some of our best ideas have been simple, based on a clear and deep understanding of our customers' working lives.



You learn a lot in 175 years

Over the years, Volvo has advanced solutions that have revolutionized the use of construction equipment. No other name speaks Safety louder than Volvo. Protecting operators, those around them and minimizing our environmental impact are traditional values that continue to shape our product design philosophy.

We're on your side

We back the Volvo brand with the best people. Volvo is truly a global enterprise, one that is on standby to support customers quickly and efficiently – wherever they are.

We have a passion for performance.

A strong, dedicated, capable dealer network.

Our dealers are strategically located throughout North America to provide the equipment you need and the parts and service support you demand for a productive and profitable operation.

The strength of our dealer network is enhanced with extensive individualized product and product support training at our state-of-the-art Technical Training Center in Asheville and through hands-on training. At our nearby 80-acre Product Demonstration Center, visitors operate equipment from our entire product line under a variety of simulated working conditions. Both facilities are in year-round use by our dealers and customers – more than 2,000 visit each year. **Building the best starts right here.**

The products designed and manufactured by Volvo Construction Equipment have their beginnings at the most advanced Research & Design centers in the industry. Volvo CE machines are designed in 11 R&D centers and produced in 15 manufacturing facilities across the world.

The major R&D center and manufacturing plant in the Americas is located in Shippensburg, Pennsylvania. This facility has been in operation for over 30 years and – with its recently added 200,000 sq. ft. expansion – now covers 570,000 sq. ft. on an 80 acre campus. Dedicated work teams and highly advanced technologies and techniques using the Volvo Production System ensure continuous quality improvements, labor savings and cost control to reach the high quality that our customers have come to expect from Volvo.



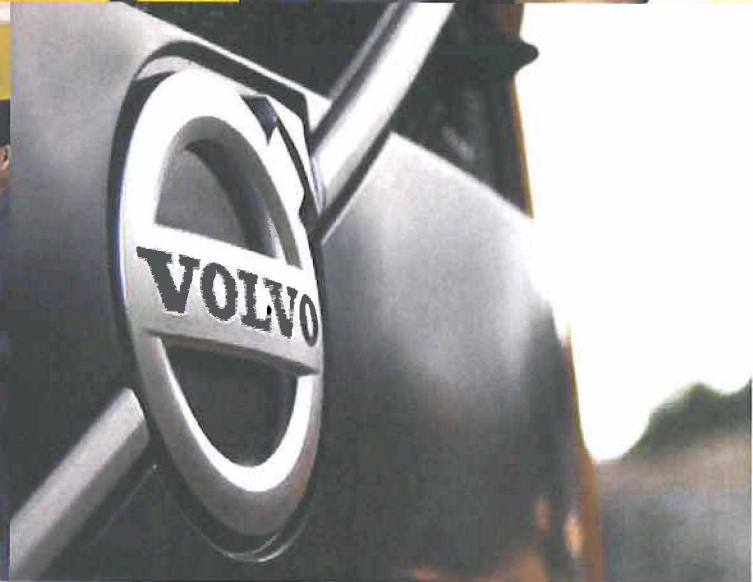
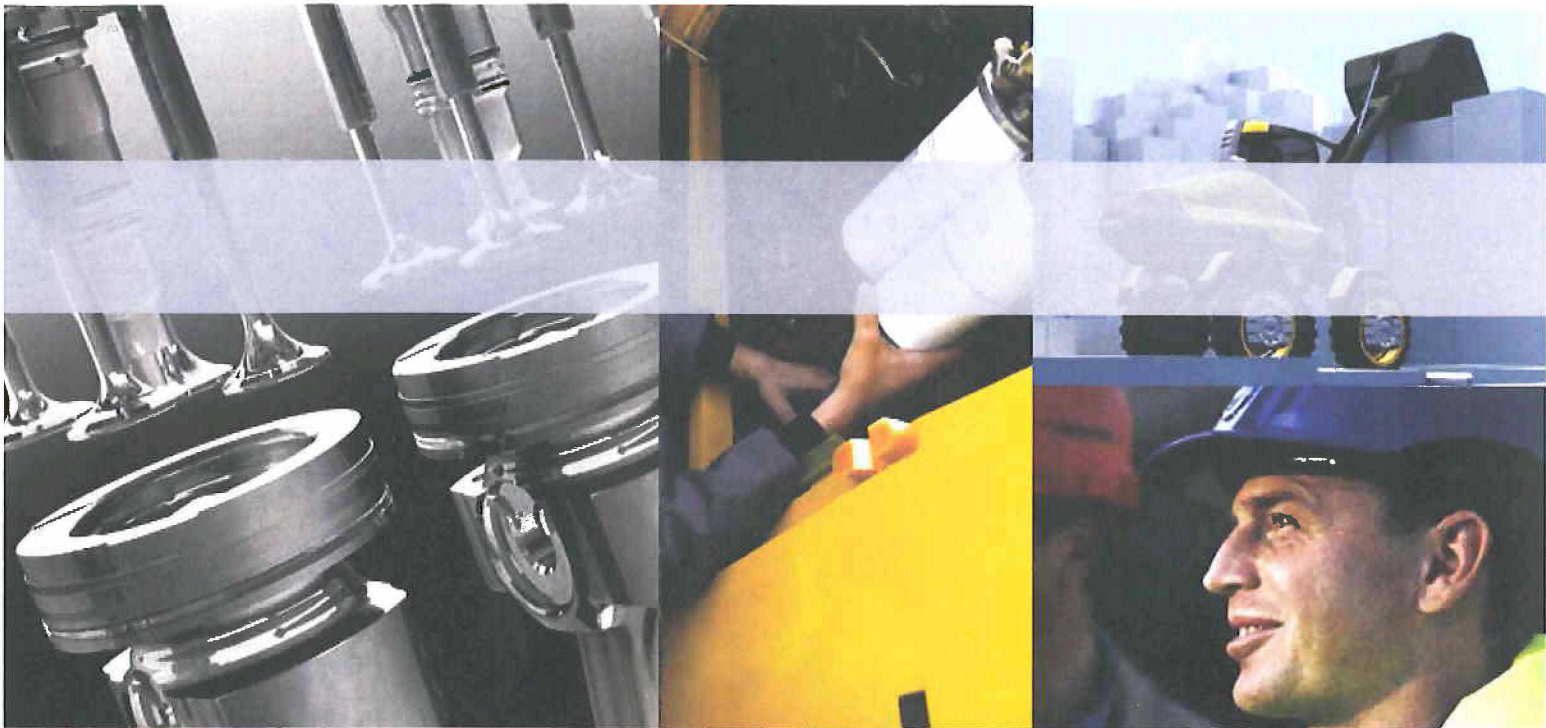

Mack Trucks



Volvo Construction Equipment



Volvo Penta



Volvo Trucks



Renault Trucks



UD Trucks



Volvo Buses



Volvo Aero

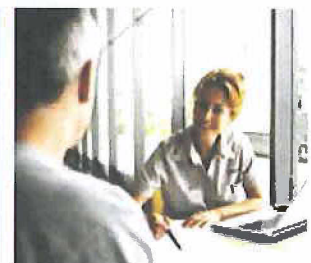

Volvo Financial Services

INTRODUCING THE BEST ALL-ROUNDER.

Volvo proudly introduces the L45G and L50G wheel loaders, built to perform on every site. The compact design enables easy maneuverability into small spaces, while Volvo's innovative TP linkage gives you the benefits of two machines in one. Experience the versatility for yourself.

Load-sensing hydraulics

Load-sensing hydraulics deliver power to hydraulic functions only when it's needed, without unnecessary oil pumping, for lower fuel consumption and more sensitivity in load handling.



High lifting force

A careful balance between lifting and tractive forces provides highly effective bucket penetration for all types of digging conditions.

Pilot-controlled valves

Smooth and precise pilot-operated hydraulics enable the operator to easily control attachments with minimum effort and high precision in all applications.

LATEST ENGINE TECHNOLOGY.

Volvo machines work hard on your job site, not on the environment. Power and efficiency are at the heart of Volvo's engine, which uses the latest technology to meet Tier 4 Interim/Stage IIIB regulations and reduce emissions as you operate. Environmentally responsible and powerful; that's Volvo.

Reduce emissions on the move

Volvo's regeneration system works to reduce emissions without interrupting operation. Particles collected during filter cleaning are oxidized and transformed into non-toxic CO₂ every 6-10 hours.

Engine cooling fan

Reduce maintenance with the reversible engine cooling fan. The automatic fan blows air back through the cooling pack to remove debris drawn into the radiator and only operates when needed to save fuel.

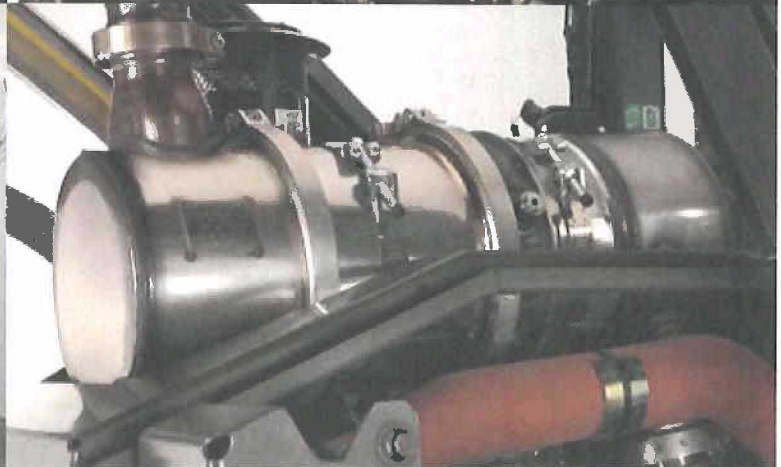
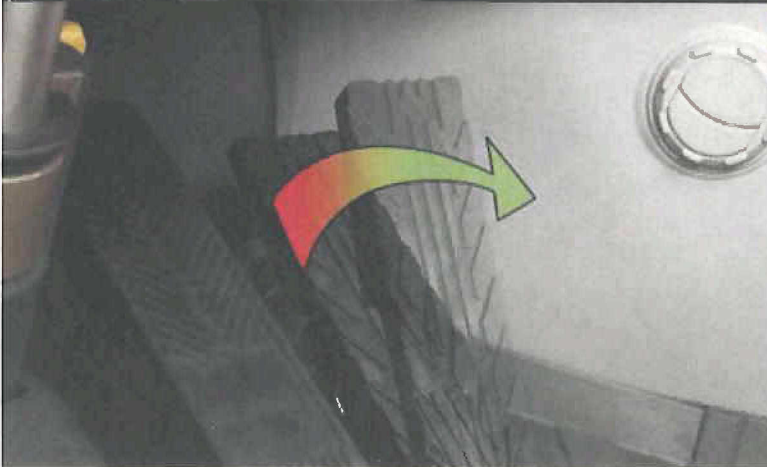

Efficient eco pedal

Avoid excessive fuel use with Volvo's new eco pedal, which encourages operators to apply the appropriate amount of pressure (push-back) on the throttle pedal, reducing fuel consumption.

Diesel Particulate Filter (DPF)

New to Tier 4, the Diesel Particulate Filter (DPF) traps and temporarily holds exhaust particulates (soot) as the machine operates, which are later incinerated inside the DPF during the regeneration process.

SMALL SIZE: BIG TALENT.

Efficient eco pedal

The eco pedal encourages operators to apply the appropriate amount of pressure (push-back) on the throttle pedal, reducing fuel consumption.



Patented TP linkage

Volvo's unique Torque Parallel linkage combines Z-Bar and Parallel linkage in one for high breakout torque and parallel movement through the entire lifting range.

Steering

Load-sensing hydrostatic steering system served from variable displacement pump. Excellent steering performance is maintained even at low engine speed. At the same time fuel consumption is reduced.

Hydraulic attachment bracket

The Volvo hydraulic attachment bracket enables quick attachment changes for more flexibility on site.

Load-sensing hydraulics

Load-sensing hydraulics deliver power to hydraulic functions only when it's needed, lowering fuel consumption.

Volvo attachments

Volvo's range of high quality attachments are perfectly matched to the machine's linkage, hydraulics and driveline to work as one unit and increase productivity.



Optimized driveline

Engine, transmission and axles work in perfect harmony with the hydraulics and steering for superb quality, performance and reliability.





Industry-leading cab

Adjustable steering wheel, seat and armrest, easily located controls and excellent all-round visibility for the perfect operator environment.

Analysis software

Maintain machine uptime by using Volvo's diagnostic computer-based analysis software: MATRIS and VCADS Pro.



CareTrack

Volvo's telematics system guides machine owners towards optimized productivity and their next service – remotely.



Maintain your uptime

The transverse mounted engine design provides easy access to all service points under the engine hood, for quick completion of maintenance checks.



Tier 4 Interim/Stage IIIB engine

Powerful, fuel efficient Volvo engine with V-ACT technology for high torque at low engine speeds. Engineered to meet Tier 4 Interim/Stage IIIB emissions requirements.

Differential lock

Select the differential lock to transfer 100% power to all wheels and reduce tire slippage for maximum traction on soft and slippery ground.

COMPACT YOUR SERVICE TIME.

Daily service and maintenance checks have never been easier thanks to the new compact design. Lift the engine hood to quickly access key components from the radiator to the hydraulic filters and use Volvo diagnostic tools to alert when service is required. Volvo keeps you working for longer.

Engine air filter

The dual element air filter is located in the engine compartment for full protection of the engine.



Analysis software

Maintain machine uptime by using Volvo's diagnostic computer-based analysis software. MATRIS assesses operational data from the machine's electronic control unit (ECU), while VCADS Pro can adjust machine function according to results.

Maintenance-free axle cradle

The rear axle cradle with integrated oscillating bearings are lubricated with the axle oil and protected by proven seals, saving you hours of maintenance time.

STRENGTH TO SUPPORT YOU AND YOUR BUSINESS.

The day you receive your new Volvo Wheel Loader is just the start of your working relationship with Volvo. From service and maintenance products to a wide range of options and attachments – Volvo has a comprehensive aftermarket portfolio to continuously add value to your business.

Customer Support Agreements - Gives you peace of mind by reducing total ownership costs, maximizing uptime, and distributing maintenance and major repair costs.



Attachments - Providing customers with a wide variety of attachments keep your machine working and open up new job opportunities.



Volvo designed and built your machines, so no-one knows how to keep them working in top condition more than us. When it comes to your machine, our Volvo trained technicians are the experts.

Our technicians work with industry leading diagnostic tools and techniques, using only Genuine Volvo Parts to deliver the highest levels of quality and service. Talk to your Volvo dealer about how genuine Volvo services can best provide the service and maintenance plan that is the right fit for you and your business.

State-of-the-art machines require state-of-the-art support and your Volvo dealer can provide a catalogue of services designed to get the most out of your machine, helping you maximise uptime, productivity and residual value. Your Volvo dealer can provide a number of sophisticated support offers, including:

Service plans ranging from routine wear inspections, through to comprehensive maintenance and repair agreements.

Analysis and diagnostics to help you understand how your machine is running, highlight potential maintenance issues and identify where performance can be improved.

Eco Operator training courses can help your operators work towards a safer, more productive and fuel efficient performance.

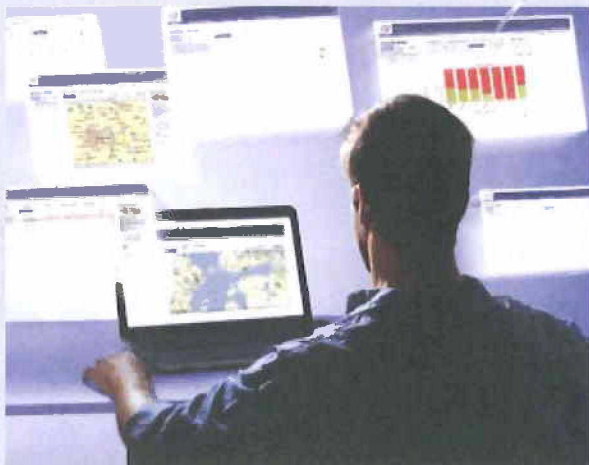

CareTrack

Volvo's state-of-the-art telematics system works with our exclusive machine tracking info system, MATRIS. CareTrack can give you the machine information needed for better planning and smarter working; such as daily usage reports, location reports and service maintenance reminders using guided diagnostics to track and analyze machines remotely. You can save fuel. You can reduce costs. You can maximize profitability. You can with CareTrack.

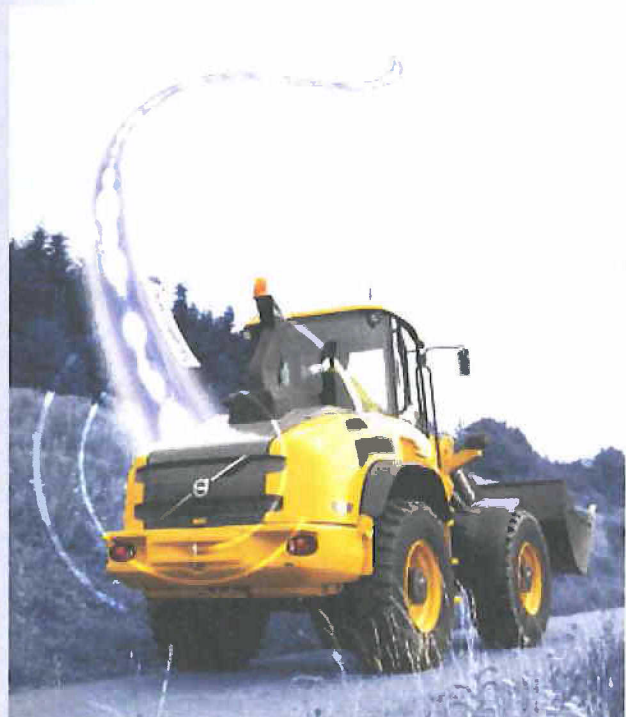

GET ATTACHED.

Get flexible on site with Volvo attachments. Choose from an extensive range of buckets, pallet forks and grapples, perfectly-matched to the machine's link-arm geometry and breakout force. Volvo's attachment brackets let you quickly interchange between options so you can 'attach and go'.

Standard Volvo Attachment Bracket

Volvo's standard hydraulic attachment bracket, is internationally ISO standardized and allows a quick and safe interchange of attachments for more flexibility on site. The strong, open bracket design enables the operator to clearly see attachment points from the cab.

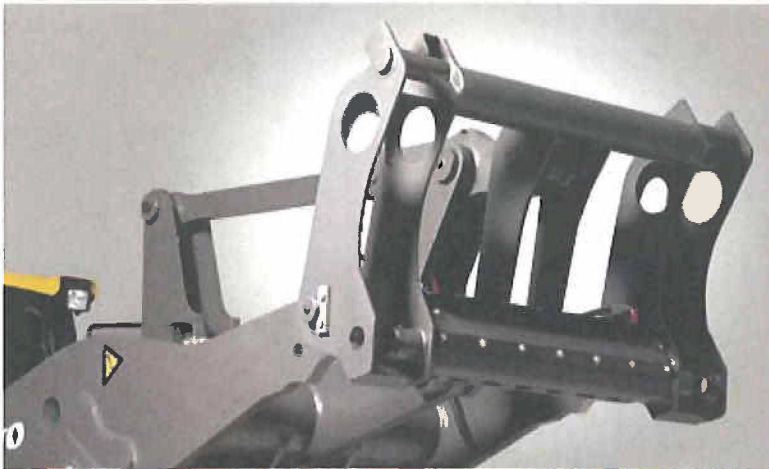

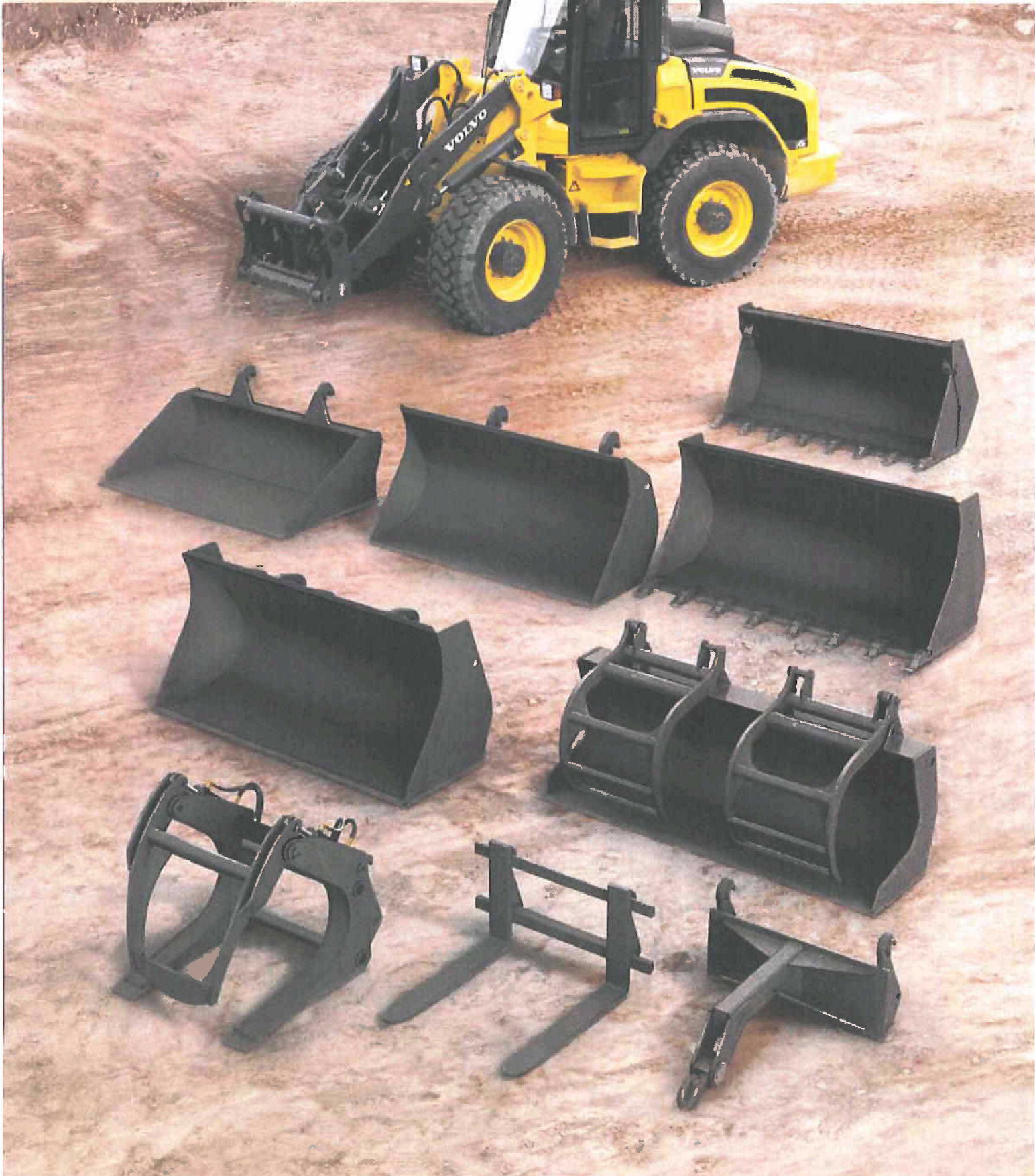

VOLVO L45G, L50G IN DETAIL.

Engine

Engine: Volvo's V-ACT Tier 4i / Stage III B approved, 4 liter, 4-cylinder in-line four stroke diesel engine, turbocharger with waste gate, Common Rail fuel injection, cooled external Exhaust Gas Recirculation (EGR), diesel particulate filter (DPF). The throttle application is transmitted electrically from the throttle pedal or the optional hand throttle.

Air cleaning: Three-stage Cyclone precleaner - primary filter - secondary filter.

Cooling system: Air-to-air cooling pack. Powerful hydraulic fan electronically controlled.

L45G		
Engine		Volvo D4H
Max power at	r/s (r/min)	30 (1,800)
SAE J1995 gross	kW (hp)	75 (101)
ISO 9249, SAE J1349 net	kW (hp)	73 (98)
Max torque at	r/s (r/min)	24.2 (1,450)
SAE J1995 gross	Nm (lbf)	425 (313)
ISO 9249, SAE J1349 net	Nm (lbf)	406 (299)
Economic working range	r/min	1,200 - 1,800
Displacement	l (in ³)	4 (244)

L50G		
Engine		Volvo D4H
Max power at	r/s (r/min)	31.7 (1,900)
SAE J1995 gross	kW (hp)	87 (117)
ISO 9249, SAE J1349 net	kW (hp)	85 (114)
Max torque at	r/s (r/min)	24.2 (1,450)
SAE J1995 gross	Nm (lbf)	490 (361)
ISO 9249, SAE J1349 net	Nm (lbf)	468 (345)
Economic working range	r/min	1,200 - 1,800
Displacement	l (in ³)	4 (244)

Hydraulic system

System supply: One load-sensing axial piston pump with variable displacement. The steering function always has priority.

Valves: Double-acting 3-spool valve (4-spool valve optional). The main valve is controlled by an appropriate pilot valve.

Lift function: The valve has four positions: Lift, hold (neutral), lower and float position. Optional inductive/magnetic automatic boom kick-out can be switched on and off and is adjustable to any position between maximum reach and full lifting height.

Tilt function: The valve has three positions: Rollback, hold (neutral) and dump. Inductive/magnetic automatic tilt can be adjusted to the desired bucket angle (bucket positioner).

Cylinders: Double-acting cylinders for all functions.

Filter: Full-flow filtration through 10 micron (absolute) filter cartridge in a combined suction-return-filter. Integrated valve for thermostatically controlled oil circuit through the oil-cooler.

L45G, L50G				
Working pressure max	Mpa (bar)		26 (260)	
Flow at Engine speed	l (US gal)/min		132 (34.9)	
Pilot working pressure	Mpa (bar)		2,5 (25)	
Cycle times		L45G	L50G	
	Raise	s	5,3	6,4
	Tilt	s	1,1	1,6
	Lower, empty	s	3,2	3,9
	Total cycle time	s	9,6	11,9

Instrumentation: All important information is centrally located in the operator's field of vision. Display for Contronic monitoring system.

Heater and defroster: Heater coil with filtered fresh air and fan with auto and 11 speeds. Defroster vents for all window areas.

Operator's seat: Operator's seat with adjustable suspension and retractable seat belt. The seat is mounted on a bracket on the rear cab wall and floor. The forces from the retractable seat belt are absorbed by the seat rails.

Standard: The cab is tested and approved according to ROPS (ISO 3471, SAE J1040), FOPS (ISO 3449). The cab meets with requirements according to ISO 6055 (Operator overhead protection - Industrial trucks) and SAE J386 ("Operator Restraint System").

L45G, L50G		
Emergency exit:		Use emergency hammer to break window
Sound level in cab according to ISO 6396:	LpA dB(A)	68
External sound level according to ISO 6395:	LwA dB(A)	102

L45G

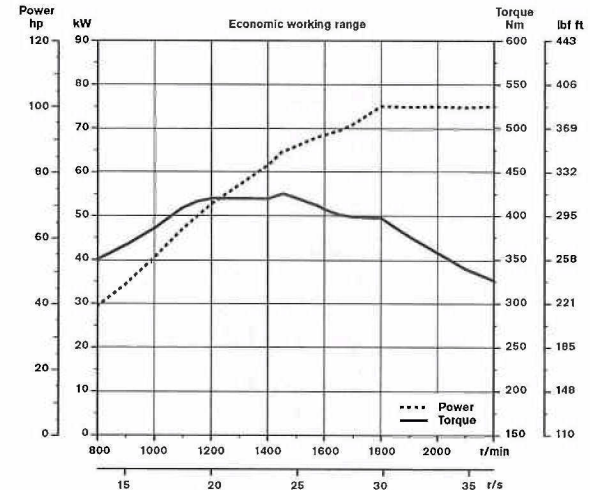

L50G

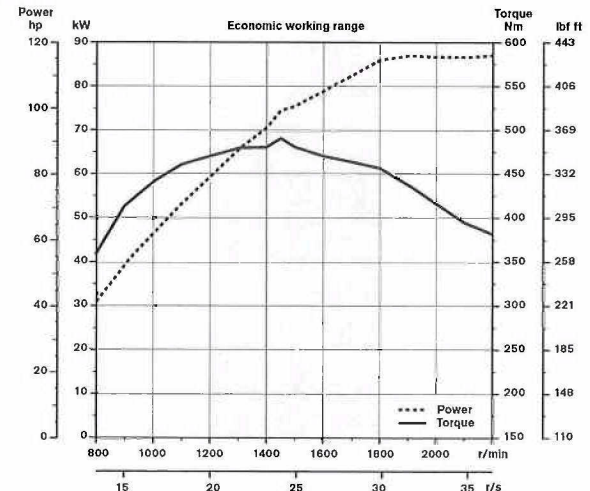

Service

Filling capacities:

Fuel tank	l (US gal)	150 (39.6)
Engine oil	l (US gal)	14 (3.7)
Engine coolant	l (US gal)	20 (5.3)
Hydraulic tank	l (US gal)	95 (25)
Transmission oil	l (US gal)	2,2 (0.58)
Front axle oil	l (US gal)	17,0 (4.5)
Rear axle oil	l (US gal)	18,3 (4.8)

Drivetrain

Transmission

The hydrostatic transmission is an infinitely variable transmission. The speed gears limit the max. travel speed within the range - without any tractive power interruption. Maximum rimpull is available in all gears, regardless of the driving direction.

Automatic regulation ensures easy operation. Load limiting control protects the engine when additional power is requested by working hydraulics and auxiliary power take-off. No overheating in overload conditions.

Axles: Volvo fully floating axle shafts with hub planetary reductions and cast steel axle housing. Fixed front axle and oscillating rear axle, self-lubricated. 100% differential lock on both axles.

Drivetrain L45G, L50G

Travel speeds (Forward / Reverse)

1st gear	km/h (mph)	0 - 5 (0 - 3.1)
2nd gear	km/h (mph)	0 - 17 (0 - 10.5)
3rd gear	km/h (mph)	0 - 40 (0 - 25)

Angle of rear axle oscillation	°	±12
Oscillation at wheel	mm (in)	360 (14.2)
at Track width	mm (in)	1 730 (68.1)

Steering

Steering system: Load sensing hydrostatic articulated steering.

System supply: The steering system has priority feed from the load-sensing axial piston pump with variable displacement.

Steering cylinders: Two double-acting cylinders. Elastic end-stops.

L45G, L50G

Steering cylinders		2
Working pressure	Mpa (bar)	17,5 (175)
Maximum flow	l min	70
	(US gal) min	(18.5)
Max articulation	°	±40

Linkage

	L45G	L50G
Linkage system		TP
Lift cylinders		2
Tilt cylinders		1
Lift time (loaded)	s	5,3 6,4
Lowering time (empty)	s	3,2 3,9
Dump time	s	1,1 1,6

Electrical system

Contronic electrical system with central warning light and buzzer, providing clear and easy to read information to the operator. LCD display with main and sub information field, adjustable to various languages.

Display information in three categories: Information on continuous operating data, Check requests (based on vehicle and error messages) and Warning (with alarm texts).

Additional audible warning by a buzzer. Indicator and activation lights for various control and monitoring functions.

Gauges for Fuel tank level, hydraulic oil temperature and engine temperature.

Keypad also provides display navigation on the central instrument. Direct access buttons for Engine, Transmission, Hydraulics, Axles & Brakes, Electric, Machine, Vehicle messages, Service and Setup. Antitheft equipment optional.

L45G, L50G

Voltage	V	24
Batteries	V	2x12
Battery capacity	Ah	2x100
Cold cranking capacity, approximate	A	830
Alternator rating	W/A	3 080/110
Starter motor output	kW (hp)	5,5 (7.4)

Brake system

Service brake: Reliable wet disc brakes with nitrogen-charged accumulators. Dual circuit on front and rear axle

Secondary brake: Dual circuit and hydrostatic retardation

Inching-brake pedal:

Hydraulic inching brake pedal provides hydrostatic braking for precise control of travel speed and service brake application.

1st stage: Wearless hydrostatic braking (inching)

2nd stage: Service brake application

Parking brake:

Dry disc brake on input shaft of front axle.

Standard: The brake system complies with the requirements of ISO 3450

L45G

Number of brake discs per wheel front/rear		1/1
Accumulators	l (US gal)	3x0,5 (3x0.13)
Accumulators for parking brake	l (US gal)	1x0,5 (1x0.13)

L50G

Number of brake discs per wheel front/rear		front 1
Accumulators	l (US gal)	2x0,5, 1x1,0 (2x0.13, 1x0.26)
Accumulators for parking brake	l (US gal)	1x1,0 (1x0.26)

SPECIFICATIONS L45G.

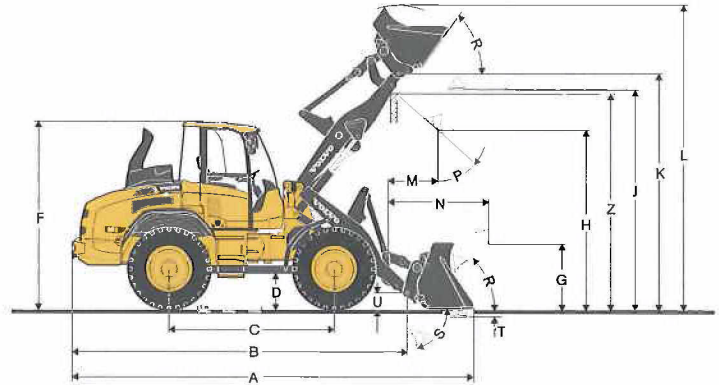
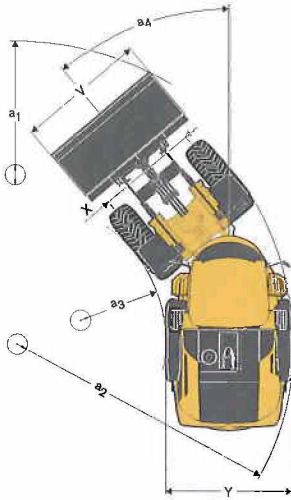

L45G

With TP-linkage, TPV attachment bracket and 17.5 R25 tires

B	mm (in)	5 280 (17' 4")
C	mm (in)	2 650 (8' 8")
D	mm (in)	435 (1' 5")
F	mm (in)	2 990 (9' 9")
G	mm (in)	1 040 (3' 4")
J	mm (in)	3 470 (11' 4")
K	mm (in)	3 725 (12' 2")
O	°	55
P	°	45
R	°	45
S	°	75
U	mm (in)	255 (10")
X	mm (in)	1 730 (5' 8")
Y	mm (in)	2 190 (7' 2")
Z	mm (in)	3 485 (11' 5")
a ₂	mm (in)	4 760 (15' 7")
a ₃	mm (in)	2 540 (8' 4")
a ₄	°	40

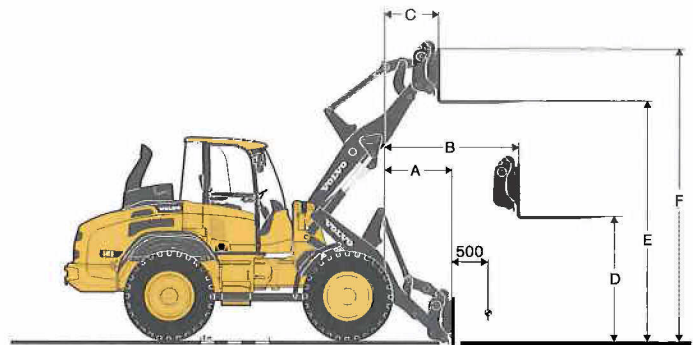

With Loading Fork

TPV attachment bracket

TPV Attachment bracket Long Boom





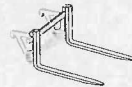

Center of gravity 500 mm (1' 8")

A	mm (in)	785 (2' 7")	1 135 (3' 9")
B	mm (in)	1 475 (4' 10")	1 745 (5' 9")
C	mm (in)	650 (2' 2")	825 (2' 9")
D	mm (in)	1 705 (5' 7")	1 705 (5' 7")
E	mm (in)	3 490 (11' 5")	3 695 (12' 2")
F	mm (in)	4 225 (13' 10")	4 430 (14' 6")
Tipping load full turn (ISO 1 4397)	kg (lb)	4 420 (9,744)	-560 (-1,234)
Working load according to EN 474-3, 60/80 %	kg (lb)	2 650 / 3 530 (5,842 / 7,782)	-340 / -450 (-749 / -992)
Working load 80%, transport position, 40° and full turn	kg (lb)	4 000 (8,818)	-



L45G

With TP-Linkage,
TPV attachment bracket
(welded version)
and 17.5 R25 tires

		GENERAL PURPOSE		LIGHT MATERIAL		4-in-1	High-Tip	LONG BOOM
								
Capacity heaped	m ³ (yd ³)	1,4 (1.8)	1,5 (2.0)	1,8 (2.4)	2 (2.6)	1,2 (1.6)	2 (2.6)	-
Material density	kg/m ³ (lb/yd ³)	1 800 (3,030)	1 700 (2,697)	1 400 (2,360)	1 200 (2,191)	1 900 (3,203)	1 000 (1,854)	-
Static tipping load, straight (ISO 14397)	kg (lb)	5 970 (13,160)	5 930 (13,073)	5 780 (12,742)	5 670 (12,500)	5 650 (12,456)	4 950 (10,912)	-
Static tipping load, full turn 40° (ISO 14397)	kg (lb)	5 290 (11,622)	5 250 (11,547)	5 120 (11,287)	5 020 (11,067)	5 000 (11,023)	4 370 (9,634)	-640 (-1,410)
Hydraulic lifting capacity, max.	kN (lbf)	70 (15,736)	69,4 (15,511)	67,5 (15,174)	66 (14,837)	66,5 (14,949)	57,5 (12,926)	-
Breakout force	kN (lbf)	62 (13,938)	59,7 (13,421)	53 (11,914)	48 (10,790)	66 (14,837)	-	-
A Total length	mm (ft/in)	6 350 (20' 10")	6 385 (20' 11")	6 505 (21' 4")	6 615 (21' 8")	6 295 (20' 8")	6 955 (22' 10")	200 (8")
L Lift height, max.	mm (ft/in)	4 740 (15' 7")	4 790 (15' 9")	4 810 (15' 9")	4 940 (16' 2")	4 815 (15' 10")	5 695 (18' 8")	-
V Bucket width	mm (ft/in)	2 250 (7' 5")	2 250 (7' 5")	2 250 (7' 5")	2 250 (7' 5")	2 250 (7' 5")	2 250 (7' 5")	-
a ₁ Clearance circle	mm (ft/in)	10 300 (33' 10")	10 320 (33' 10")	10 390 (34' 1")	10 460 (34' 4")	10 305 (33' 10")	10 675 (35')	-
T Digging depth	mm (ft/in)	85 (3")	85 (3")	85 (3")	85 (3")	120 (5")	95 (4")	-
H Dump height, 45°	mm (ft/in)	2 800 (9' 2")	2 780 (9' 1")	2 690 (8' 10")	2 610 (8' 7")	2 790 (9' 2")	4 230 (13' 11")	-
M Reach at max. height	mm (ft/in)	930 (3' 1")	945 (3' 1")	1 025 (3' 4")	1 100 (3' 7")	815 (2' 8")	1 490 (4' 11")	170 (7")
N Reach, max.	mm (ft/in)	1 750 (5' 9")	1 770 (5' 10")	1 850 (6' 1")	1 925 (6' 4")	1 640 (5' 5")	2 670 (8' 9")	270 (10')
Operating weight	kg (lb)	8 630 (19,026)	8 650 (19,070)	8 660 (19,092)	8 690 (19,158)	8 850 (19,511)	9 090 (20,040)	-

SPECIFICATIONS L50G.

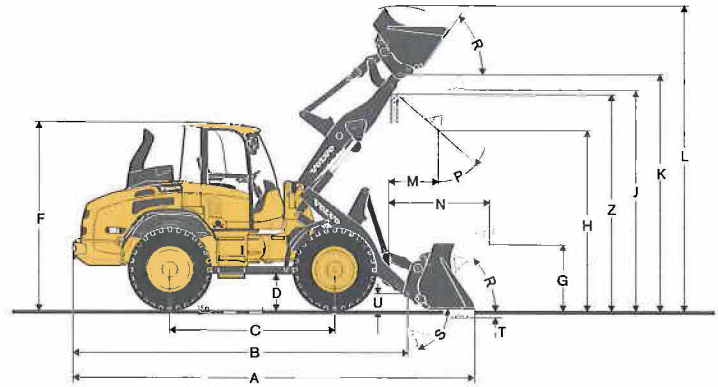
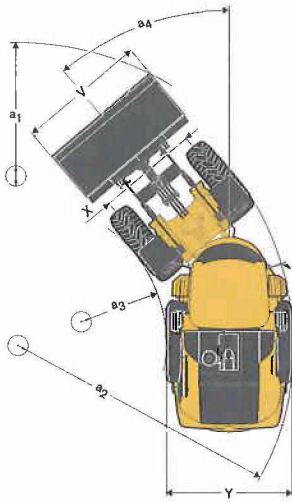

L50G

With TP-linkage, TPV attachment bracket and 17.5 R25 tires

B	mm (in)	5 380 (17' 8")
C	mm (in)	2 650 (8' 8")
D	mm (in)	435 (1' 5")
F	mm (in)	2 980 (9' 9")
G	mm (in)	1 000 (3' 3")
J	mm (in)	3 525 (11' 7")
K	mm (in)	3 780 (12' 5")
O	°	54
P	°	45
R	°	44
S	°	76
U	mm (in)	255 (10")
X	mm (in)	1 730 (5' 8")
Y	mm (in)	2 190 (7' 2")
Z	mm (in)	3 535 (18' 2")
a ₂	mm (in)	4 760 (15' 7")
a ₃	mm (in)	2 540 (8' 4")
a ₄	°	40

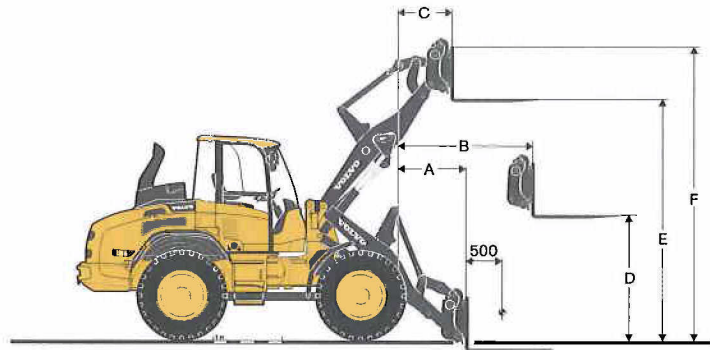

With Loading Fork

TPV attachment bracket

TPV Attachment bracket Long Boom







Center of gravity 500 mm (1' 8")

A	mm (in)	800 (2' 8")	1 060 (3' 6")
B	mm (in)	1 505 (4' 11")	1 705 (5' 7")
C	mm (in)	655 (2' 2")	785 (2' 7")
D	mm (in)	1 745 (5' 9")	1 745 (5' 9")
E	mm (in)	3 585 (11' 9")	3 735 (12' 3")
F	mm (in)	4 320 (14' 2")	4 470 (14' 8")
Tipping load full turn (ISO 14397)	kg (lb)	4 810 (10,604)	-420 (-926)
Working load according to EN 474-3, 60/80 %	kg (lb)	2 880 / 3 840 (6,349 / 8,466)	-240 / 120 (- 530 / - 265)
Working load 80%, transport position, 40° and full turn	kg (lb)	4 000 (8,818)	-



L50G

With TP-linkage,
TPV attachment bracket
(cast version)
and 17.5 R25 tires

		GENERAL PURPOSE		LIGHT MATERIAL		4-in-1	High-Tip	LONG BOOM
								
Capacity heaped	m ³ (yd ³)	1,5 (2.0)	1,6 (2.1)	1,8 (2.4)	2 (2.6)	1,4 (1.8)	2,3 (3.0)	-
Material density	kg/m ³ (lb/yd ³)	1 900 (3,203)	1 700 (2,865)	1 500 (2,528)	1 300 (2,191)	1 900 (3,203)	1 000 (1,686)	-
Static tipping load, straight (ISO 14397)	kg (lb)	6 560 (14,462)	6 510 (14,352)	6 400 (14,110)	6 290 (13,867)	6 080 (13,404)	5 550 (12,236)	-
Static tipping load, full turn 40° (ISO 14397)	kg (lb)	5 810 (12,809)	5 750 (12,677)	5 670 (12,500)	5 570 (12,280)	5 390 (11,883)	4 910 (10,825)	-510 (-1,124)
Hydraulic lifting capacity, max.	kN (lbf)	86,5 (19,446)	86 (19,334)	84,5 (18,996)	83 (18,659)	81,5 (18,322)	73 (16,411)	-
Breakout force	kN (lbf)	72 (16,186)	69 (15,512)	64 (14,388)	58 (13,039)	65 (14,613)	-	-
A Total length	mm (ft/in)	6 460 (21' 2")	6 495 (21' 4")	6 580 (21' 7")	6 690 (21' 11")	6 560 (21' 6")	7 030 (23' 1")	150 (6")
L Lift height, max.	mm (ft/in)	4 880 (16' 0")	4 900 (16' 1")	4 980 (16' 4")	5 235 (17' 2")	4 905 (16' 1")	5 915 (19' 5")	-
V Bucket width	mm (ft/in)	2 250 (7' 5")	2 250 (7' 5")	2 250 (7' 5")	2 250 (7' 5")	2 250 (7' 5")	2 250 (7' 5")	-
a ₁ Clearance circle	mm (ft/in)	10 360 (34')	10 385 (34' 1")	10 435 (34' 3")	10 505 (34' 6")	10 475 (34' 4")	10 740 (35' 3")	-
T Digging depth	mm (ft/in)	95 (4")	95 (4")	95 (4")	95 (4")	130 (5")	105 (4")	-
H Dump height, 45°	mm (ft/in)	2 865 (9' 5")	2 845 (9' 4")	2 775 (9' 1")	2 695 (8' 10")	2 745 (9')	4 330 (14' 2")	-
M Reach at max. height	mm (ft/in)	965 (3' 2")	1 000 (3' 3")	1 040 (3' 5")	1 115 (3' 8")	965 (3' 2")	1 505 (4' 11")	130 (5")
N Reach, max.	mm (ft/in)	1 810 (5' 11")	1 830 (6')	1 890 (6' 2")	1 970 (6' 6")	1 810 (5' 11")	2 710 (8' 11")	200 (8")
Operating weight	kg (lb)	9 410 (20,745)	9 430 (20,790)	9 420 (20,767)	9 450 (20,834)	9 670 (21,319)	9 890 (21,804)	-

EQUIPMENT.

STANDARD EQUIPMENT

	L45G	L50G		L45G	L50G
Engine			Cab, Interior		
Diesel engine, direct fuel injection	*	*	Air conditioner	*	*
Extra fuel filter	*	*	Heater with air-filter and defroster (front/rear)	*	*
Cold start aid	*	*	Adjustable steering column Left armrest	*	*
Dry-type air filter	*	*	Cab, Interior		
Preparation for pre-cleaner	*	*	Seat belt	*	*
Filtration screens on air inlets	*	*	Sun visor	*	*
Reversible cooling fan	*	*	Cab filtration	*	*
Electrical system			Hook for coat	*	*
Alternator 55 A	*	*	Cup holder	*	*
Lighting			Emergency hammer	*	*
Main head lights (halogen) upper/dipped/asymmetrical	*	*	Storage box in the cab	*	*
Working lights (2 front/2 rear)	*	*	Rear view mirrors (left/right)	*	*
Parking lights	*	*	Working Equipment		
Rear lights	*	*	Automatic bucket leveller	*	*
Brake lights	*	*	Hydraulic quick-change attachment bracket	*	*
Direction indicators	*	*	Carriage Body		
Hazard warning lights	*	*	Fenders (front/rear)	*	*
Reversing lights	*	*	Fender extensions (optional)	*	*
Cab lighting	*	*	Lockable engine hood	*	*
Instrumentation & controls			Lockable fuel-tank cap	*	*
Multi-function joystick	*	*	Vertical exhaust	*	*
24 Volt accessories socket	*	*	Towing device	*	*
Forward horn	*	*	Lifting eyes	*	*
Hazard warning switch	*	*	International Standards for Machines and Production		
Safety start	*	*	Quality: DIN/ISO 9001	*	*
Electronic Information System			Safety: CE - Criteron	*	*
Analog information for:			Machine guide-lines 2006/42/EC	*	*
Fuel level	*	*	ROPS ISO 3471	*	*
Engine temperature	*	*	FOPS ISO 3449	*	*
Drive system oil temperature	*	*	Operating weight ISO 7131	*	*
LED-illuminated symbols (color-coded) for:			Tipping load / Payload: ISO 14397-1	*	*
Direction (forward/reverse)	*	*	EMC (Electromagnetic Compatibility)	*	*
Indicators (left/right)	*	*	89/336/EEC plus supplement	*	*
Pre-heater (option)	*	*	Environment: DIN/ISO 14001	*	*
Main beam head lamp	*	*	Sound regulation: 2000/14/EC	*	*
Differential locks	*	*			
Boom suspension system (option)	*	*	OPTIONAL EQUIPMENT (Standard on certain markets)		
Loading fork operation (option)	*	*			
LED-illuminated symbols (red) with acoustic signal for:				L45G	L50G
Parking brake	*	*	Service		
Air filter restriction	*	*	Wheel chock	*	*
Drive system oil temperature	*	*	Tool Kit	*	*
Engine temperature	*	*	Central Lub. unit (Volvo)	*	*
Engine oil pressure	*	*	Engine		
Battery charging	*	*	Hand inch valve	*	*
Return filter	*	*	Hand throttle	*	*
Touch pad with symbols and integrated LEDs for:			Turbo II Prefilter	*	*
Parking lights	*	*	Air pre-cleaner, oil-bath type	*	*
Working lights (front/rear)	*	*	Tropical cooling	*	*
Windscreen wiper (rear)	*	*	Fuel pre-heater	*	*
Rotating beacon (option)	*	*	Electrical		
Boom suspension system on/off (option)	*	*	Rotating beacon foldable	*	*
Locking and activation of Volvo-attachment bracket	*	*	Prep. rotating beacon magnetic	*	*
Activation of multi-function joystick for directional change	*	*	Rev. alarm audible switchable	*	*
Digital LED display activated by dual function keys for:			Reverse alarm audible	*	*
Entry and retrieval of operating information	*	*	Rev. alarm audio vis. switchable	*	*
Optional anti-theft function control	*	*	Anti theft device	*	*
Drivetrain			Rear lights protection	*	*
Hydrostatic drive	*	*	Headlights protection	*	*
Operator-selected 100% differential locks in both axles	*	*	Working lights guards, front/rear	*	*
Tires 17.5 R25	*	*	Xenon work lights, front/rear	*	*
Hydraulic system			Care Track GSM	*	*
Load-Sensing Hydraulics	*	*	Care Track Satellite	*	*
Axial piston pump	*	*	Transport lights	*	*
Control valve three-spool system	*	*	El. headlights 350 mm (1' 2")	*	*
3rd hydraulic circuit and couplings	*	*	Road light equipment width 2.5 m (8' 2")	*	*
Cab, Exterior			Power outlet 12 V	*	*
ROPS/FOPS cab with flexible mountings	*	*	Rotating beacon magnet	*	*
Lockable door	*	*	Cab		
All-round tinted safety glass	*	*	Door all glass	*	*
Windscreen wiper (front/rear)	*	*	Foldable r.h. window	*	*
Windscreen washer (front/rear)	*	*	Split door	*	*
Door stops	*	*	Seat fab. air/susp. heat	*	*
External rear view mirrors (right/left)	*	*	Seat mec./susp.	*	*
Cab filtration system	*	*	Radio preparation 12 V	*	*
Cab, Interior			Radio	*	*
4-way adjustable operator's seat	*	*	Heated rearview mirrors	*	*
Left armrest	*	*	Rearview mirrors inside cab	*	*

OPTIONAL EQUIPMENT (Standard on certain markets)

	L45G	L50G
Cab		
1 lever ctrl. incl. 3rd hyd. function	•	•
3 lever ctrl.	•	•
4 lever ctrl. incl. 4th hyd. function	•	•
Seat belt 3"	•	•
Comfort drive control (CDC)	•	•
Hydraulics		
Hyd. oil mineral VG46 HV	•	•
Hydr. Couplings	•	•
Boom suspension system	•	•
Tilt speed limiter mechanical	•	•
Boom kickout	•	•
4th function	•	•
Tilt control	•	•
Hyd. oil BIOSynth VG46 HLP PA	•	•
Hyd. oil mineral VG68 HV	•	•
Safety valve for tilt cylind.	•	•
Hyd. oil mineral VG32 HV	•	•
Extra oil ret. line via filter	•	•
Other		
Color Level 1 (yellow parts)	•	•
Preparation for licence plate	•	•
Side marking reflectors	•	•
SMV warning triangle	•	•
Trailer socket	•	•
Belly guards, front/rear	•	•
Windshield guard, rear	•	•
Windshield guard, front	•	•
Protect. wax coating incl. cyl.	•	•
Engine hood protection	•	•
Color Level 1+2	•	•
Auto Engine Shutdown L45/50G	•	•
GY TL-3A+ 17.5 R25	•	•
Removable rear left fender	•	•
Tires		
Front Mud flaps	•	•
MI 17.5R25 XHA	•	•
MI 15.5R25 XHA	•	•
GY 15.5-25 SGL	•	•
Mudguard extension 75 mm	•	•
Extended mud flaps	•	•
GY 17.5-25 SGL	•	•
GY 17.5R25 RT-3B	•	•
NO 540/65R24 TRI2	•	•
BR 17.5R25 VSW B2,25	•	•
MI 15.5R25 XMINE-D2	•	•
Wheels for transport only	•	•
MI 500/70 R24 XMCL	•	•
NO 440/80R24 TRI 2	•	•
MI 17.5R25 XMINE-D2	•	•
TR 600/55-265 T421	•	•
MI 17.5R25 XHA B2,4	•	•
BR 15.5R25 VUT	•	•
MI 15.5R25 XHA B2,4	•	•
GY 17.5R25 RT-3B B2,4	•	•
GY 550/65R25 GP-3D	•	•
MI 17.5R25 XHA SPW	•	•
High flow 125 l/min	•	•
Long boom	•	•
ATTACHMENTS		
Buckets		
Straight with teeth and bolt on edges	•	•
High tipping	•	•
Light material	•	•
Multi purpose Grading	•	•
Clamp	•	•
Other attachments		
Log grapples	•	•
Forks	•	•
Material handling arm	•	•

SELECTION OF VOLVO OPTIONAL EQUIPMENT

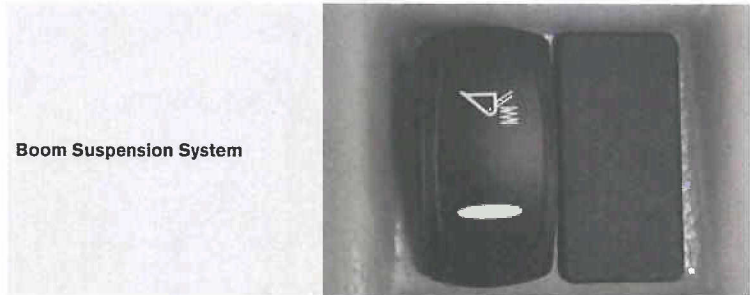

Boom Suspension System

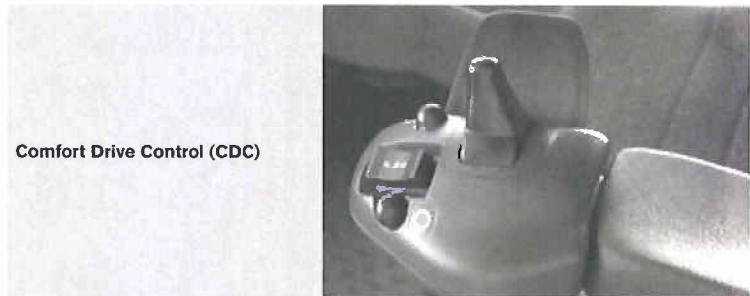

Comfort Drive Control (CDC)



Hydraulic 3rd and 4th function



Tilting condenser



Automatic Lubrication System

VOLVO CONSTRUCTION EQUIPMENT



Volvo Construction Equipment is different. Our machines are designed, built and supported in a different way. That difference comes from an engineering heritage of over 175 years. A heritage of thinking first about the people who actually use the machines. About how to help them be safer, more comfortable, more productive. About the environment we all share. The result of that thinking is a growing range of machines and a global support network dedicated to helping you do more. People around the world are proud to use Volvo. And we're proud of what makes Volvo different.

Not all products are available in all markets. Under our policy of continuous improvement, we reserve the right to change specifications and design without prior notice. The illustrations do not necessarily show the standard version of the machine.

VOLVO

Volvo Construction Equipment
www.volvoce.com/na

Ref. No. VOE2210009251
Printed in USA 03/12 - 0,0
Volvo, Asheville
Copyright © 2012 Volvo

English
USA