



# PHOTOS FROM SOUTH END OF LONG BEACH PENINSULA



**RIVER OUTLET**









# REDUCING PLASTIC DEBRIS IN THE LOS ANGELES AND SAN GABRIEL RIVER WATERSHEDS



## Project Members

Jessica Midbust  
Michael Mori  
Paula Richter  
Bill Vosti

## Project Advisor

Derek Booth

## Project Client

Algalita Marine  
Research Institute

## Bren Masters Project Brief

### Purpose and Objectives

The overarching purpose of this project was to conduct an analysis of the sources and movement of plastic debris in the Los Angeles and San Gabriel River Watersheds, and to examine and recommend policies to reduce the amount that enters the waterways and thus has the potential to end up being discharged to the Pacific Ocean. To our knowledge, this is the first project of this type to focus locally on the source, impacts, and transport of plastic debris in a highly urbanized region.

Plastic debris has the potential to negatively impact marine and terrestrial ecosystems, and has social impacts through degraded beaches, declining real estate values, and detrimental health effects.

We conducted an analysis of the sources and movement of plastic debris in the Los Angeles and San Gabriel River Watersheds and recommend 16 action items, based on a qualitative assessment of feasibility and effectiveness, to reduce plastic debris. These action items have the potential to substantially reduce the flow of plastics to the ocean, beaches, and rivers, benefiting a wide range of local stakeholders, and setting a precedent for the application of this type of assessment and implementation in similar highly urbanized watersheds.

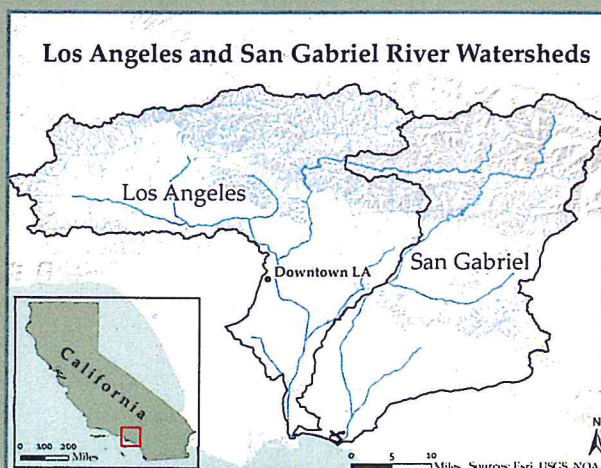

### Methods

Given the broad scope of the project, multiple methods were used to collect and analyze information and data related to plastic debris. Interviews with more than 60 professionals with knowledge of plastic debris and/or policy were conducted, and an extensive literature review related to the current knowledge of the issue was completed. To complement this information, visits to both watersheds and a plastic production facility were used to enhance our understanding of plastic debris in the region. Data on plastic debris quantity and characterization was collected from government and nongovernment agencies. The data were then analyzed using various statistical methods. Finally, all of the previous research and findings were synthesized into policy recommendations, ranked by feasibility and effectiveness.



# General Findings

## Magnitude of the Plastic Debris Problem

- ◆ Plastic is ubiquitous on beaches, in rivers, on city streets, and in the ocean
- ◆ Plastic is transported by wind and water to the environment
- ◆ Plastic production has increased by ~5% per year for the past two decades
- ◆ The supply of new plastic products maintains a steady stream of plastic debris
- ◆ Population density is positively correlated with increased plastic debris levels

## Land-Based Sources of Plastic Debris

- ◆ ~50% of the trash entering the ocean is from land-based sources
- ◆ ~50% of trash found in beach and river cleanups is plastic debris
- ◆ ~50% of that trash is plastic debris
- ◆ ~50% of all plastic debris is single-use packaging items
- ◆ Single-use plastic packaging is commonly littered

## Impacts of Plastic Debris

- ◆ Plastic debris impacts wildlife through ingestion and entanglement
- ◆ Plastic debris persists in the environment for tens to hundreds of years
- ◆ Plastic debris transports invasive species
- ◆ Plastic pollution poses risks to human health
- ◆ Plastic pollution cleanup efforts have significant economic impacts

## The Costs of Litter

In California, waterway and beach cleanups, street sweeping, storm drain cleaning and maintenance, manual cleanup, and anti-litter campaigns cost over \$400 million per year.



# Conceptual Model

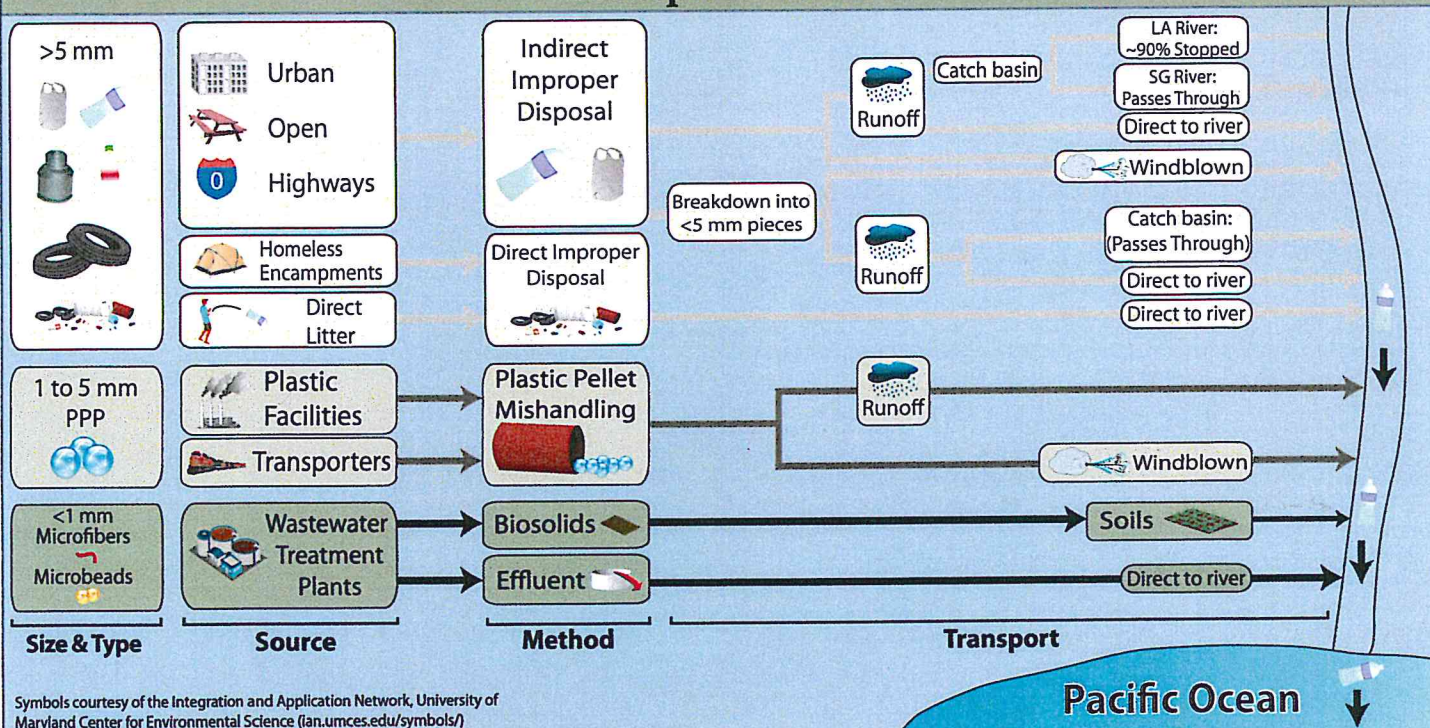

Symbols courtesy of the Integration and Application Network, University of Maryland Center for Environmental Science ([ian.umces.edu/symbols/](http://ian.umces.edu/symbols/))

This model represents the flow of plastics from different sources into local waterways



## LOS ANGELES AND SAN GABRIEL RIVER WATERSHED FINDINGS

**Dense urban landscapes are often associated with more impervious surfaces which increase runoff**, a primary transport mechanism of plastic debris. This runoff may be stormwater from intense winter storms or from general water use during the dry season, such as landscaping, street cleaning, and car washing. Both types of runoff can transport plastic debris that has been collecting on city streets to the Los Angeles and San Gabriel Rivers through storm drains. Plastic debris can also be transported to the rivers via wind action and by people dumping trash directly into the rivers.

**Littering** is one of the largest sources of plastic debris. While millions of littering events occur every year in the Los Angeles region, only an estimated ~7,000 citations are issued. Plastic debris makes up ~50% of all littered trash in the watersheds.

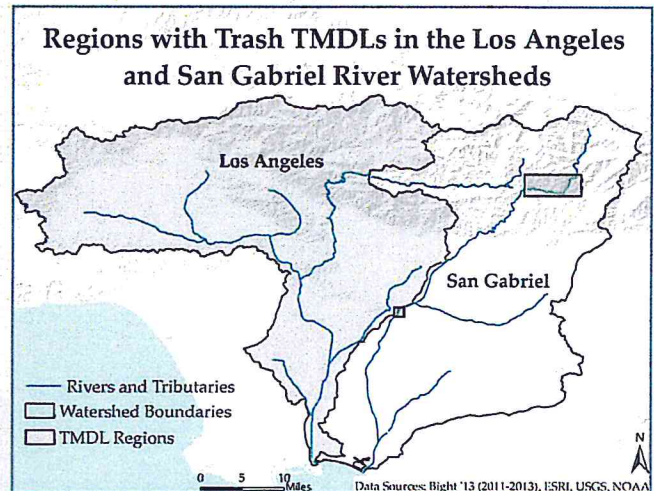
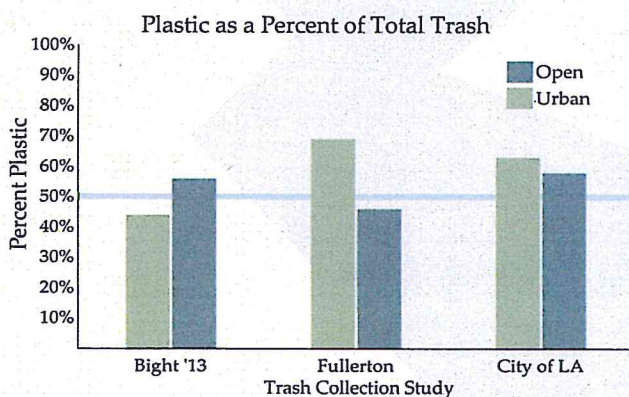

Another source of plastic are preproduction plastics. **Preproduction plastic spills are common within the industry** and the high volume of small producers makes monitoring and enforcement.

The four most common types of plastic debris were found to be **cigarette butts, polystyrene, food packaging, and plastic bags**. These items all share the same characteristic of being single-use items.

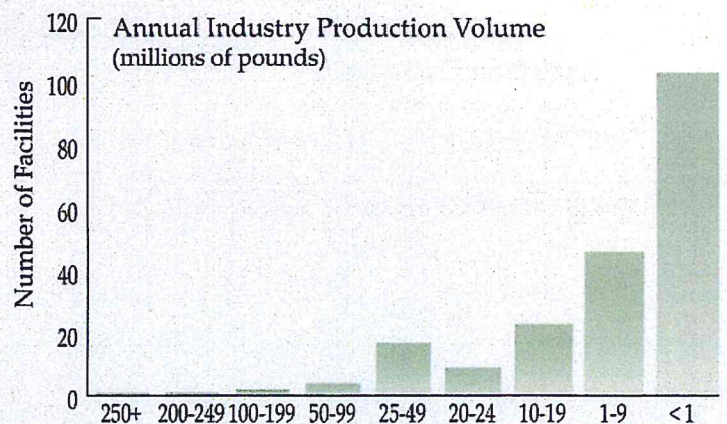
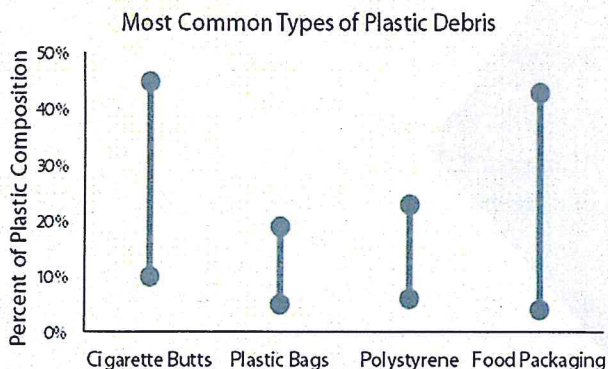

The Los Angeles region attempts to address the plastic debris problem through Trash **Total Maximum Daily Loads** (TMDLs), but the San Gabriel region has only two regions covered under such trash load limits.

**Microplastics** such as microbeads (used in cosmetics) and microfibers (used in clothing) are an emerging type of plastic debris. We estimated that approximately one billion microplastics have the potential to be discharged annually into the Los Angeles and San Gabriel River Watersheds from wastewater treatment plants.



## Recommendations

This project culminated in a suite of 16 recommended action items, ranked through a qualitative assessment of feasibility and effectiveness based on our findings. The recommendations were placed into three tiers. For feasibility, political and economic criteria were used. Effectiveness was based on an assessment of the likely impact on reducing plastic debris.

### TIER 1 ACTION ITEMS

1. **Increase litter law enforcement, outreach, and education** using a civil administrative approach, continuance of the "Erase the Waste" campaign to ensure ongoing anti-littering messaging, and expansion of K-12 environmental education.
2. **Ban single-use plastic grocery bags and polystyrene containers (e.g., Styrofoam™)** which are common litter items; bans have already been successfully enacted in numerous cities throughout California.
3. **Implement a comprehensive San Gabriel River Watershed Trash Total Maximum Daily Load** that addresses trash that is smaller than 5 mm in size, includes open space recreational areas, and mandatory monitoring.
4. **Reduce single-use plastic items** through point-of-sale fees, expansion of the California Redemption Value program, and container exchange programs.
5. **Collect information to better track plastic facilities** by adding a checkbox on business license forms to identify preproduction plastic facilities to compile a shared database to better track these facilities.

### TIER 2 ACTION ITEMS



6. **Amend the Los Angeles River Watershed Trash Total Maximum Daily Load**
7. **Collect better data and standardize protocols**
8. **Advance extended producer responsibility programs**
9. **Increase recycling efforts**
10. **Improve participation and establish metrics for the Operation Clean Sweep industry program**

### TIER 3 ACTION ITEMS

11. **Incentivize plastic packaging innovations**
12. **Address litter from homeless encampments through data collection and outreach**
13. **Enact comprehensive statewide plastic debris legislation**
14. **Improve the Long Beach trash boom and add additional trash booms**
15. **Declare plastic as a hazardous substance**
16. **Develop marine biodegradable plastic materials**



### Acknowledgements

Our sincerest gratitude to **Dr. Derek Booth**, our faculty advisor; **Drs. Patricia Holden** and **Mark Anthony Browne**, our external advisors; **Algalita Marine Research Institute**, our client; and the individuals and organizations that provided us with data: **Adam Furman** – California State University, Fullerton; **Kirsten James** – Heal the Bay; **Sherry Lippiatt** – National Oceanic and Atmospheric Administration; **Alfredo Magallanes** – City of Los Angeles, Bureau of Sanitation; **Shelly Moore** – Southern California Coastal Water Research Project; **Dylan Seidner** – California Water Board; **Ted Von Bittner** – AMEC Environment and Infrastructure, Inc.; and **John "Alan" Walti** – Surfrider Foundation.





# Reducing Plastic Debris in the Los Angeles and San Gabriel River Watersheds

## Team:

Jessica Midbust

Michael Mori

Paula Richter

Bill Vosti

## Advisor:

Derek Booth

**April 2014**



Bren School of Environmental Science & Management  
University of California, Santa Barbara

A Group Project submitted in partial satisfaction  
of the requirements for the degree of  
Master of Environmental Science and Management

**Client:** Algalita Marine Research Institute



As authors of this Group Project report, we are proud to archive this report on the Bren School's website such that the results of our research are available for all to read. Our signatures on the document signify our joint responsibility to fulfill the archiving standards set by the Bren School of Environmental Science & Management.

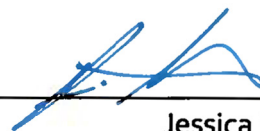

Jessica Midbust



Michael Mori



Paula Richter



Bill Vosti

The mission of the Bren School of Environmental Science & Management is to produce professionals with unrivaled training in environmental science and management who will devote their unique skills to the diagnosis, assessment, mitigation, prevention, and remedy of the environmental problems of today and the future. A guiding principal of the School is that the analysis of environmental problems requires quantitative training in more than one discipline and an awareness of the physical, biological, social, political, and economic consequences that arise from scientific or technological decisions.

The Group Project is required of all students in the Master of Environmental Science and Management (MESM) Program. The project is a three-quarter activity in which small groups of students conduct focused, interdisciplinary research on the scientific, management, and policy dimensions of a specific environmental issue. This Group Project Final Report is authored by MESM students and has been reviewed and approved by:



Derek Booth

March 2013



# ACKNOWLEDGEMENTS

---

We would like to express our sincerest gratitude to the individuals and organizations that made this report possible. Foremost, we would like to thank our faculty advisor Dr. Derek Booth, for his guidance and invaluable insights.

We would like to thank the following individuals from Algalita Marine Research Institute for proposing this Group Project and supporting us throughout the development of this report: Charles Moore, Founder; Marieta Francis, Executive Director; Gwen Lattin and Ann Zellers, Research Biologists; and Judith Marquez, Research Coordinator.



We also want to extend thanks to our external advisors, Drs. Patricia Holden and Mark Anthony Browne, for sharing their scientific knowledge and technical expertise.

Furthermore, we would like to acknowledge the following individuals and organizations for providing us with data for this project:

Adam Furman, Graduate Student  
California State University, Fullerton

Alfredo Magallanes, PE  
City of Los Angeles - Bureau of Sanitation

Dylan Seidner, Environmental Scientist  
State Water Resources Control Board

Kirsten James, Director of Water Quality  
Heal the Bay

Shelly Moore, Information Management and Analysis  
Southern California Coastal Water Research Project

Sherry Lippiatt, California Regional Coordinator  
National Oceanic and Atmospheric Administration  
Marine Debris Program

Ted Von Bitner, Project Technical Lead  
AMEC Environment and Infrastructure, Inc.



# ACRONYMS

---

ACC	American Chemistry Council
AMRI	Algalita Marine Research Institute
ASTM	American Society for Testing and Material
BMP	Best Management Practice
BPA	Bisphenol A
CRV	California Redemption Value
DDT	Dichlorodiphenyl trichloroethane
DEHP	Di (2-ethylhexyl) phthalate
EPA	Environmental Protection Agency
HDPE	High-Density Polyethylene
LA River	Los Angeles River
LA River Watershed	Los Angeles River Watershed
LARWQCB	Los Angeles Regional Water Quality Control Board
LDPE	Low-Density Polyethylene
MS <sub>4</sub>	Municipal Separate Storm Sewer Systems
NOAA	National Oceanic and Atmospheric Administration
NPDES	National Pollution Discharge Elimination System
OCS	Operation Clean Sweep
PAH	Polycyclic aromatic hydrocarbon
PCB	Polychlorinated biphenyl
PET/PETE	Polyethylene terephthalate
POP	Persistent Organic Pollutant
PP	Polypropylene
PS	Polystyrene
PVC	Polyvinyl chloride
RIC	Resin Identification Code
SG River	San Gabriel River
SG River Watershed	San Gabriel River Watershed
SIC	Standard Industrial Classification
SPI	Society of the Plastics Industry
SWRCB	State Water Resources Control Board
TMDL	Total Maximum Daily Load
Trash TMDL	Trash Total Maximum Daily Load
WWTP	Wastewater Treatment Plant



# TABLE OF CONTENTS

---

ABSTRACT .....	8
EXECUTIVE SUMMARY .....	9
1 PURPOSE AND OBJECTIVES .....	14
2 SIGNIFICANCE OF PROJECT .....	15
3 BACKGROUND .....	16
3.1 HISTORY .....	16
3.2 COMPOSITION .....	17
3.2.1 COMPOSTABLE PLASTICS .....	19
3.2.2 MARINE COMPOSTABILITY .....	19
3.3 THE WATERSHEDS .....	20
3.3.1 LOS ANGELES RIVER WATERSHED .....	20
3.3.2 SAN GABRIEL RIVER WATERSHED .....	21
3.4 CURRENT POLICY .....	22
3.4.1 GLOBAL .....	22
3.4.2 FEDERAL .....	23
3.4.3 CALIFORNIA .....	23
3.5 SIMILAR RESEARCH .....	23
4 METHODS .....	25
4.1 INTERVIEWS .....	25
4.2 LITERATURE REVIEW .....	25
4.3 SITE VISITS .....	26
4.4 CONCEPTUAL MODEL .....	26
4.5 DATA ANALYSES .....	26
4.6 POLICY RECOMMENDATIONS .....	27
5 FINDINGS .....	28
5.1 GENERAL .....	28



5.1.1 THE MAGNITUDE OF PLASTIC DEBRIS IS WELL UNDERSTOOD.....	28
5.1.2 THE IMPACTS OF PLASTIC DEBRIS ARE WELL UNDERSTOOD.....	30
5.1.3 THE SOURCES OF PLASTIC DEBRIS ARE WELL UNDERSTOOD.....	35
<b>5.2 LOS ANGELES AND SAN GABRIEL RIVER WATERSHEDS.....</b>	<b>39</b>
5.2.1 THE TRANSPORT OF PLASTIC DEBRIS IN THE WATERSHEDS ARE WELL UNDERSTOOD.....	39
5.2.2 ZERO TRASH TMDLS ARE HIT OR MISS.....	42
5.2.3 ASSESSING THE QUANTITY AND CHARACTERIZATION OF PLASTIC DEBRIS IN THE WATERSHEDS.....	53
5.2.4 PEOPLE LITTER – A LOT!.....	70
5.2.5 MICROPLASTICS ARE AN EMERGING TYPE OF PLASTIC DEBRIS.....	76
5.2.6 INDUSTRY PLAYS A ROLE IN THE PLASTIC DEBRIS PROBLEM.....	80
<b>6 RECOMMENDED ACTIONS TO REDUCE PLASTIC DEBRIS.....</b>	<b>88</b>
<b>6.1 TIER 1 ACTION ITEMS.....</b>	<b>89</b>
6.1.1 LITTER LAW ENFORCEMENT, OUTREACH, AND EDUCATION.....	89
6.1.2 BANS ARE NECESSARY: PLASTIC GROCERY BAGS AND POLYSTYRENE.....	91
6.1.3 IMPLEMENT A SAN GABRIEL RIVER WATERSHED TRASH TMDL.....	99
6.1.4 REDUCE SINGLE-USE PLASTIC.....	101
6.1.5 COLLECT BETTER BUSINESS LICENSE INFORMATION TO TRACK INDUSTRY.....	105
<b>6.2 TIER 2 ACTION ITEMS.....</b>	<b>106</b>
6.2.1 AMEND THE LA RIVER WATERSHED TRASH TMDL.....	106
6.2.2 COLLECT BETTER DATA NOW.....	110
6.2.3 PRODUCER RESPONSIBILITY SHOULD BE EXTENDED.....	115
6.2.4 INCREASE RECYCLING RATES.....	116
6.2.5 OPERATION CLEAN SWEEP IMPROVEMENTS.....	118
<b>6.3 TIER 3 ACTION ITEMS.....</b>	<b>119</b>
6.3.1 PACKAGING INNOVATIONS NEED TO BE INCENTIVIZED.....	119
6.3.2 HOMELESS ENCAMPMENTS SHOULD BECOME A PRIORITY.....	122
6.3.3 CALIFORNIA NEEDS MORE COMPREHENSIVE PLASTIC LEGISLATION AND A STATEWIDE TRASH POLICY.....	126
6.3.4 TRASH BOOMS COULD BE AN IMPROVED LAST LINE OF DEFENSE.....	129



6.3.5 DECLARE PLASTIC A HAZARDOUS SUBSTANCE.....	131
6.3.6 COMPOSTABLE PLASTIC IS NOT QUITE READY FOR THE MAINSTREAM.....	132
<b>7 CONCLUSIONS.....</b>	<b>134</b>
APPENDIX A - FIGURES.....	A-2
APPENDIX B - TABLES.....	A-4
APPENDIX C – PLASTIC DEBRIS LITERATURE REVIEW.....	A-5
APPENDIX D – SUMMARY OF RESEARCH ON BIOTIC CONSUMPTION AND ENTANGLEMENT.....	A-42
APPENDIX E – SUMMARY OF RESEARCH ON TRANSPORT MECHANISMS.....	A-58
APPENDIX F – SUMMARY OF RESEARCH ON DEGRADATION AND CONTAMINANTS.....	A-60
APPENDIX G – CONTACT LIST.....	A-64
APPENDIX H – DATA INDEX.....	A-67
APPENDIX I – STATE WATER RESOURCES CONTROL BOARD PLASTIC FACILITIES SURVEY SUMMARY.....	A-69
APPENDIX J - REFERENCES.....	A-101

Photo: Michael Mori





---

## ABSTRACT

---

The overarching purpose of this project was to conduct an analysis of the sources and movement of plastic debris in the Los Angeles and San Gabriel River Watersheds. Plastic debris has the potential to negatively impact marine and terrestrial ecosystems, and has social impacts through degraded beaches, declining real estate values, and detrimental health effects. Current management efforts have not reduced excessive transport of plastic debris from the terrestrial environment to non-impactful levels. To our knowledge, this is the first project that has focused on identifying the major sources of terrestrial plastic debris in a highly urbanized region. Through our analysis, litter was found to be the main source. A suite of recommended action items, based on a qualitative assessment of feasibility and effectiveness, include litter reduction efforts, product bans, comprehensive statewide legislation, improvement of local regulatory mechanisms, increased monitoring of production facilities, reduction in single-use items, product innovations, and improved data collection methods. These action items have the potential to substantially reduce the flow of plastics to the ocean, beaches, and rivers, benefiting a wide range of local stakeholders, and setting a precedent for the application of this type of assessment and application in other highly urbanized watersheds.



---

# EXECUTIVE SUMMARY

---

We conducted a comprehensive analysis of the sources, types, and movement of plastic debris in the Los Angeles and San Gabriel River Watersheds (LA and SG River Watersheds), and then examined and recommended policy actions to reduce those flows. To our knowledge, this is the first project of this type to focus on the issue of plastic debris in a highly urbanized area at a regional level.

A byproduct of the growth of plastic use, plastic litter went largely unnoticed until the 1970s because it was considered a minor problem that was primarily aesthetic in nature. By the mid- to late-1980s, the presence of plastics in the marine environment had been well documented and scientists, nonprofit organizations, and governments turned their attention toward the sources, quantity, and distribution of those plastics. For the past two decades, scientific research into plastic debris has also begun to focus on the breakdown of plastics into smaller particles, as well as the emerging issue of microbeads and microfibers.

A variety of legislation has been implemented to reduce the quantity of plastic debris deposited directly into the open ocean and to make those responsible for the debris liable for cleanup and mitigation. However, there have been no land-based trash policies on a global scale implemented to date.

Under the Clean Water Act, the U.S. government takes the position that discharging pollutants, such as plastic debris, into waterways is a privilege and not a right. The Clean Water Act established the National

Pollutant Discharge Elimination System (NPDES) to regulate these discharges. The State and Regional Water Boards administer NPDES permits in the LA and SG River Watersheds. The Industrial Stormwater General NPDES permit is used to regulate discharges from plastic-production facilities; the Municipal Separate Storm Sewer System (MS4) NPDES permit is used to regulate discharges from municipalities through Trash Total Maximum Daily Loads (TMDLs).

Dense urban landscapes are often associated with more impervious surfaces which increase runoff, a primary transport mechanism of plastic debris. This runoff may be stormwater from intense winter storms or from general water use during the dry season, such as landscaping, street cleaning, and car washing. Both types of runoff can transport plastic debris that has been collecting on city streets to the LA and SG Rivers through storm drains. Plastic debris can also be transported to the rivers via wind action and by people dumping trash directly into the rivers.

Given the broad scope of our project, multiple methods were used to collect and analyze information and data related to plastic debris. Interviews with more than 60 professionals with plastic debris and/or policy knowledge were conducted, and an extensive literature review (over 300 articles and reports) related to the current knowledge of the issue was completed. To complement this information and enhance our understanding, we visited both watersheds and a plastic manufacturing facility. Furthermore, data on plastic debris quantity and characterization were collected



---

from government agencies, research institutions, and nonprofit organizations, and analyzed using statistical and analytical

methods. Finally, 16 action items to reduce plastic debris were proposed.

***The magnitude of the plastic debris problem is well understood***

Plastic production has been on the rise since its development in the early 1900s. The resilient properties of plastic allow it to persist for tens to hundreds of years (depending on its composition) in the environment. Even over long periods of time, most plastic does not completely decompose but instead breaks down into smaller pieces. The manufacture and sale of new plastic products maintains a steady stream of plastic debris that has the potential to enter the environment. Global plastic production over the last 20 years has increased by an average of 5% per year, with 280 million tons of plastic produced in 2012.

California's waste stream consisted of nearly 9% plastic in 2000 and generated about 3.5 million tons of trash. Plastic films were the most abundant, followed by durable

plastic items, plastic trash bags, and industrial packaging films (CCG, 2004). Categorizing the sources by land-use types, plastic waste makes up 9.4% of the total residential waste stream by weight and 12% of the commercial waste stream by weight (CCG, 2004).

Between what is produced, what is sent to landfills, and what is recycled, the remainder of plastic waste ends up as litter and makes its way into the environment.

The accumulation of plastic debris in the ocean often concentrates in gyres (such as the North Pacific Subtropical Gyre) where oceanic currents converge in a circular vortex. Due to the rotating currents that trap debris, these gyres have become the focus of numerous marine studies to document the accumulation of plastic debris (NOAA, 2012).

***The impacts of plastic debris in the environment are fairly well understood***

As plastic debris continues to litter beaches, rivers, and the ocean, its presence and damaging effects on biological, ecological, and economic systems are becoming apparent. Its versatility, durability, and persistence in the environment cause plastic debris to impact nearly every marine ecosystem.

Gradually, through wave action, photo-degradation, oxidation, and hydrolysis, large pieces of plastic will break down into smaller microparticles. These smaller pieces can cause adverse effects on marine life. Once in the ocean, plastics can be ingested by marine

species, entangle biota, assist in the spread of invasive species, leach harmful chemicals, accumulate on the marine floor, and inhibit critical natural processes.

The impacts to humans from plastic debris are also significant. Economic impacts include cleanup costs, loss of tourism dollars, and devalued real estate. Health impacts include the effects of exposure to toxins released by plastics as well as here are differences in these single-use categories of plastic between urban and open land uses in the LA and SG River Watersheds.

---

### ***The sources of plastic debris are well understood, but difficult to quantify***

Much of the plastic that ends up as debris has fragmented or degraded by the time it enters waterways. Compounded by wind circulation patterns and ocean transport mechanisms, the sources of plastic debris are difficult to quantify. Plastic, due to its lightweight characteristics, has the potential to be blown from one place to another, complicating source identification. Finally, methodologies and standards vary greatly with respect to plastic debris collection efforts. Some studies

focus on count, others on weight, and still others on volume.

Plastics have consistently been identified as the majority (between 60%-80%) of marine debris over the past several decades. The focus of this report is on land-based sources of this marine debris, which we broadly divide into seven general categories: litter, stormwater discharge, industry, storm events, transport of litter, municipal landfills, and wastewater treatment plants.

### ***The methods by which plastics enter the environment are well understood***

Current estimates suggest that ~50% of all trash entering the marine environment derives from land-based sources, ~50% of which is plastic. Similarly, plastic debris collected in river and beach cleanups accounts for about half of all the trash collected; of this plastic debris, ~50% is single-use plastic packaging items.

Trash that is improperly disposed of (i.e., “litter”) has the potential to end up on streets, in stormwater systems, and in waterways. From our analyses we have concluded that urban runoff is the primary source of marine

debris, and the primary source of trash within urban runoff is litter.

Population size has been correlated with land-based contributions of plastic debris – regions with larger populations tend to have higher debris loads. Land use has also been correlated with plastic debris sources. Commercial land use is consistently associated with higher loads of debris of all kinds when compared with residential and mixed land uses. Data collected and analyzed from the LA and SG River Watersheds aligned with these global, national, and state findings.

### ***Analysis of plastic debris in the watersheds points to single-use plastic***

Through our compilation analyses of regional trash collection studies, the four most common types of plastic debris were found to be cigarettes, polystyrene, food packaging, and plastic bags. These items all share the same characteristic of being single-use items.

Statistical analyses of the trash collection studies showed that there are differences in these single-use categories of plastic between urban and open land uses in the LA and SG River Watersheds.



---

### ***The Trash TMDLs in the watersheds are hit or miss***

The Los Angeles Regional Water Quality Control Board, which oversees the LA and SG River Watersheds, has established three Trash Total Maximum Daily Loads in the watersheds: the LA River Watershed, East Fork San Gabriel River, and Legg Lake TMDLs. A Trash TMDL limits the maximum amount of trash that can enter a water body daily.

To comply with the LA River Watershed Trash TMDLs, municipalities have installed thousands of catch basin inserts with mesh screens that capture any object greater than 5 mm in size. These have been successful at reducing larger plastic items, but the TMDLs do not address smaller than 5 mm plastic

### ***Microplastics are an emerging type of plastic debris***

Microplastics such as microbeads (used in cosmetics) and microfibers (used in clothing) are an emerging type of plastic debris. Microbeads and microfibers have been increasingly detected in the environment. These plastics are often smaller than 1 mm and may have significant environmental impacts, such as sorption of pollutants, transport of invasive species, and ingestion by wildlife.

Microplastics are likely to transport to wastewater treatment plants due to the way

### ***Industry plays a role in the plastic debris problem***

Industry and manufacturing processes involve the use of raw materials to form or mold plastics for a multitude of commercial products. These raw materials are called preproduction plastics and come in the forms of resins, powders, and pellets (< 5 mm in size). Preproduction plastic has been reported

debris. Additionally, trash from mountainous areas in the region with no catch basins, windblown trash, and trash that is directly disposed of into the river (e.g., from riverside homeless encampments) are not addressed with catch basin inserts.

The East Fork San Gabriel River and Legg Lake Trash TMDLs both suffer from a lack of oversight and monitoring. In trash collection studies in the region, the East Fork San Gabriel River consistently ranks as having one of the highest trash collection counts, even though the TMDL has been in effect since 2001.

they are used and disposed of. We estimated that approximately one billion microplastics have the potential to be discharged annually into the LA and SG River Watersheds from these plants. Contrary to this estimate, interviews with wastewater treatment plant employees indicated that they did not believe microplastics were being discharged from the plants. Instead, they believed the microplastics were either settling into the biosolids or not entering the plants to begin with.

to enter the environment, mainly through accidental spills during transport or handling. Operation Clean Sweep, a voluntary industry program implemented to reduce these spills has low participation rates. Regulatory mechanisms meant to prohibit these discharges, such as the Industrial Stormwater

---

General Permit, are not well enforced or monitored. Ineffective enforcement and monitoring may be due to difficulty in identifying which production facilities should

be covered under the permit and lack of financial resources at the State and Regional Water Quality Control Boards.

### ***Recommended action items***

---

To address the problem of plastic debris in the LA and SG River Watersheds, we recommend the implementation of 16 action items, derived from a qualitative assessment of currently effective policies and development of our own solutions. Implementation of these action items would not only benefit a wide range of local stakeholders, but

also has the potential to set a precedent for implementation in similar watersheds. We have prioritized these action items into three tiers, placed in descending order based on our evaluation of relative feasibility of implementation and effectiveness at reducing plastic debris:

#### **Tier 1**

- Increase litter law enforcement, outreach, and education
- Ban plastic grocery bags and single-use polystyrene (e.g., Styrofoam™)
- Implement a comprehensive San Gabriel River Watershed Trash TMDL
- Reduce single-use plastic items through point-of-sale fees, increased redemption programs, and container exchange programs
- Collect better business license information to more effectively track plastic facilities

#### **Tier 2**

- Amend the Los Angeles River Trash TMDL to cover trash that is smaller than 5 mm, from open areas, and from direct improper disposal
- Develop standardized plastic debris data collection protocols that include size, source, and type
- Advance extended producer responsibility programs (product stewardship)
- Increase recycling efforts
- Improve the Operation Clean Sweep voluntary plastic industry program through increased participation and implementation of effectiveness metrics

#### **Tier 3**

- Incentivize packaging innovations
- Address litter from homeless encampments through data collection and outreach
- Enact uniform, comprehensive plastic debris legislation at the state level
- Improve the Long Beach trash boom and add additional trash booms
- Declare plastic as a hazardous substance
- Continue development and research of marine biodegradable plastic materials



---

# 1 PURPOSE AND OBJECTIVES

---

The overarching purpose of this project was to analyze the sources and movement of plastic debris in the Los Angeles and San Gabriel River Watersheds (LA and SG River Watersheds), and to examine and recommend policies to reduce those emissions. This was accomplished by completion of the following objectives:

## **Background Investigation**

We interviewed government and nongovernment agency staff, scientists, and other stakeholders as identified by our client, Algalita Marine Research Institute, external advisors, and others who had knowledge or data that would inform the project.

## **Literature Review**

We reviewed the literature describing work on the issue of plastic debris, with a focus on urban watersheds with characteristics similar to, and including, the LA and SG River Watersheds.

## **Conceptual Model**

We developed a conceptual model to serve as a guide in quantitatively and qualitatively assessing sources, transport, and breakdown of plastic debris in the LA and SG River Watersheds.

## **Quantitative Analyses**

We identified, analyzed, and synthesized existing data on the sources and movement of plastic debris in the two watersheds. From these data, we quantitatively reported the quantity and characterization of plastic debris in the watersheds.

## **Policy Analysis and Policy Recommendations**

We reviewed current policies with regard to plastic debris in rivers in the LA and SG River Watersheds, as well as similar regions around the world. We determined the best policies and management practices for industry and governmental agencies and provided recommendations to reduce the flow of plastic debris in the watersheds.

*"Management efforts have not succeeded at significantly reducing the discharge of plastic debris from the land to the ocean"*

## 2 SIGNIFICANCE OF PROJECT

---

The accumulation of plastic debris in ocean gyres, on beaches, and in rivers has garnered worldwide media attention (New York Times, 2012, October 15). This plastic debris has the potential to negatively affect marine and terrestrial ecosystems, and industries such as tourism and real estate that rely on clean beaches and rivers to maintain aesthetic and financial value. Much of the scientific and media focus has been on the accumulation of plastic debris in the North Pacific Gyre, where large quantities have accumulated over the past few decades.

According to the National Marine Debris Monitoring Program, 49% of marine debris derives from land-based sources, 17% is attributed to ocean-based sources, and the remaining 34% comes from either land- or ocean-based sources (EPA, 2012). The ecological, health, and aesthetic problems associated with the accumulation of plastic debris in the ocean, on beaches, and in rivers cannot be effectively managed until land-based plastic debris is better understood.

Our client, Algalita Marine Research Institute (AMRI), has participated in efforts to address the terrestrial sources of plastic debris in the

marine environment through their funding of research, education, and restoration since 1994. AMRI is located in Long Beach next to the outlets of the Los Angeles and San Gabriel Rivers that are the focus of this project. Substantial amounts of plastic debris have been measured flowing to the ocean from these two rivers. Due to their location, AMRI has an interest in developing a more thorough understanding of the movement of plastic debris in these watersheds, including their quantity, characteristics, and sources (Moore et al., 2011).

Management efforts have not succeeded at significantly reducing the discharge of plastic debris from the land to the ocean. A more comprehensive understanding of the sources and movements of plastic debris in these watersheds has led to the development of recommendations for policies to reduce plastic debris. These recommended action items, if implemented, would lead to a significant reduction in discharges of plastic to the ocean, beaches, and rivers, benefiting a wide range of local stakeholders and setting a precedent for the application of this type of assessment in similar watersheds.



---

## 3 BACKGROUND

---

### 3.1 HISTORY

---

Plastics are nothing new to the history of humankind. Ancient cultures dating back to 1600 BC learned to turn natural rubber into useful items, including balls, sculptures, and even adornments. Over the next 250 years, people experimented with many different forms of natural polymers and resins, waxes, and rubber (Andrady et al., 2009). By the 1940s, the mass production of plastics had begun (Hirai et al., 2011; Plastics Europe, 2010).

Plastics were a revolutionary material at the time of their discovery because they were light, durable, strong, inexpensive, and they could be used to produce a plethora of products that were useful to both industry and consumers (Derraik, 2002). In 1945, the chemists Yarsley and Couzens marveled at the invention in a Science Digest article (Thompson et al., 2009). Credited with coining the term the “Plastic Age,” they wrote a book that same year entitled “Plastics,” describing the life of a person born 70 years after the beginning of the “Plastic Age”:

*“This [imaginary] plastic man will come into a world of colour and bright shining surfaces where childish hands find nothing to break, no sharp edges, or corners to cut or graze, no crevices to harbor dirt or germs .... The walls of his nursery, his bath ... all his toys, his cot, the moulded light perambulator in which he takes the air, the teething ring he bites, the unbreakable bottle he feeds from*

*[all plastic]. As he grows he cleans his teeth and brushes his hair with plastic brushes, clothes himself within plastic clothes, writes his first lesson with a plastic pen and does his lessons in a book bound with plastic. The windows of his school curtained with plastic cloth entirely grease- and dirt-proof ... and the frames, like those of his house are of moulded plastic, light and easy to open never requiring any paint. [and as he reaches old age] ... wears a denture with silent plastic teeth and spectacles with plastic lenses ... until at last he sinks into his grave in a hygienically enclosed plastic coffin.”*

~Yarsley and Couzens, 1945

Synthetic plastics provided many benefits over natural materials in a wide variety of applications. Plastic products are credited with numerous health benefits by providing clean drinking water supplies, medical devices, and food packaging that reduces spoilage and transportation damage. Other benefits include a reduction of transportation costs due to their lightweight, energy-saving applications, durability, and low production cost (Andrady et al., 2009).

A byproduct of the growth of plastic use, plastic litter, went largely unnoticed until the 1970s because it was considered a minor problem that was primarily aesthetic in nature (Derraik, 2002; Laist, 1987). That changed

---

as major newspapers such as The New York Times began reporting on the subject, with headlines as early as 1971, such as “We are Killing the Sea Around Us” (Harwood, 1971) and “The Very Dirty Sea Around Us” (Lyons, 1973). The main concern during this period was petroleum pollution, but scientists soon discovered that plastics were also appearing in the world’s oceans (Derraik, 2002; Gregory, 1983; Laist, 1987; Shaw, 1977; Shaw et al., 1979; Wong et al., 1976). Scientists studying wind and ocean circulation began considering how those patterns might affect the flow of oil, plastics, and other pollutants (Shaw et al., 1979; Wong et al., 1976). As research continued into the 1980s, there was an increasing awareness that plastics were generating a waste management problem of significant local and global proportions (Gregory, 1983; Laist, 1987; Pruter, 1987). Numerous nonprofit organizations also emerged during this period with a specific focus on addressing the problem of plastic debris in the environment.

By the mid- to late-1980s, the presence of plastics in the marine environment had been

well documented and scientists, nonprofits, and governments turned their attention toward the sources, quantity, and distribution of those plastics (Day et al., 1987; Derraik, 2002; Gregory, 1983; Laist, 1987; Pruter, 1987; Wolfe, 1987). In 1989, the National Oceanic and Atmospheric Administration (NOAA) created a model that predicted the presence of a plastic gyre in the North Pacific Ocean (Day et al., 1990; NOAA, 1990).

Scientific research into plastic debris has begun to focus on the breakdown of plastics into smaller particles in the past two decades. These smaller particles are commonly referred to as “microplastics” because of their size (even though many are still visible to the naked eye).

The current state of knowledge concerning the sources, abundance, composition, and impacts of plastics, and the policies that have been put into place to regulate their entry into the environment, are reviewed in the following sections. A discussion is also included of the available information specific to the regions under study, the Los Angeles and San Gabriel River Watersheds.

## 3.2 COMPOSITION

---

Plastic is a synthetic polymer made from petrochemicals, such as oil and natural gas. The most common types of plastic are derived from hydrocarbon monomers that can be separated into two broad categories: thermoset and thermoplastic. Thermoplastics are more widely produced than thermosets and include five common types: high-density

polyethylene (HDPE), polypropylene (PP), polyvinyl chloride (PVC), polystyrene (PS), and polyethylene terephthalate (PET/PETE). A brief description and common uses for these five thermoplastics are set forth in Table 3-1, the majority of which are used to produce buoyant end products.



**Table 3-1 Thermoplastics – Descriptions and Uses**

Thermoplastic Type	Description	Uses
HDPE/LDPE	High-density polyethylene/Low-density polyethylene. Typically translucent plastic; stiff; good barrier to gases and liquids; durable under stress and strain; strong resistance to chemical breakdown	Milk and juice containers; water bottles; film used in trash bags and t-shirts; toys; trash cans; household cleaning products; food items with short shelf lives
PP	Polypropylene. Strong resistance to chemical breakdown; low density; high heat tolerance; easy to process	Packaging products; hot liquid beverage containers; flexible and stiff packaging; automotive products
PVC	Polyvinyl chloride. Strong physical properties; low heat resistance (does not combust or catch on fire easily, but has a low “softening” point); major benefit is that it can be made transparent	60% of PVC products utilize the rigid nature of the plastic; more pliable applications include construction materials (pipe, siding, windows); cable and wire insulation; synthetic leathers; medical tubing
PET/PETE	Polyethylene terephthalate. Clear and tough plastic; efficient at containing gases and moisture	Soft drink bottles; food containers; clothing; insulation; furniture; luggage; health care products
PS	Polystyrene. Can be foamed or rigid; low melting point	Foam containers; packaging; insulation

*DERIVED FROM REPORTS PREPARED BY CALRECYCLE (2008).*

To distinguish the types of plastics found in products, the Society of the Plastic Industry (SPI), a plastics industry trade association, developed resin identification codes (RIC) that correspond with different types of plastic. RIC codes are used to label plastic types. The purpose of an RIC code is to make recycling plastic waste easier for consumers by

enabling them to identify the type of plastic in an item and then determine whether or not it is recyclable, but not all plastics marked with these codes are recyclable. RIC codes have proved useful in identifying the most common types of plastic found in the environment (EPA<sup>1</sup>, 2013).

---

### 3.2.1 COMPOSTABLE PLASTICS

---

Typical thermoplastics have a chemical structure that is not conducive to fast natural breakdown. In theory, biodegradable plastics are designed to degrade quickly under certain environmental conditions (typically heat induced). Terminology surrounding biodegradable plastics is not yet consistent; the terms biodegradable, bioplastic, bio-based polymers, and compostable plastics are often used interchangeably.

Compostable plastics refers to items that degrade in compost, either anaerobically (without oxygen) or aerobically (with oxygen) due to the presence of heat and microorganisms. This differs from the biodegradable criteria in that it has a

temporal factor of breakdown, as well as limitations of toxicity. Some compostable plastic materials need heat that can only be provided by industrial compost facilities, while others can be composted at home in smaller scale lower heat compost bins.

Currently, plastics that are held together with non-plastic degradable binding units can be labeled as biodegradable. The problem with these products is that small plastic pieces remain when they biodegrade. These items can be broken down into pieces that are no longer visible to the naked eye, but are available for consumption and uptake by organisms.

### 3.2.2 MARINE COMPOSTABILITY

---

Bio-based, compostable, and biodegradable plastics do not easily decompose in marine systems due to the specific requirements for compostability (e.g., heat and an abundance of microorganisms). Ocean salinity, decreased water temperature, and a lack of soil

microorganisms inhibit their breakdown (Moore et al., 2011), although a company named Metabolix may have developed a compostable product that breaks down in the presence of common marine microorganisms.



## 3.3 THE WATERSHEDS

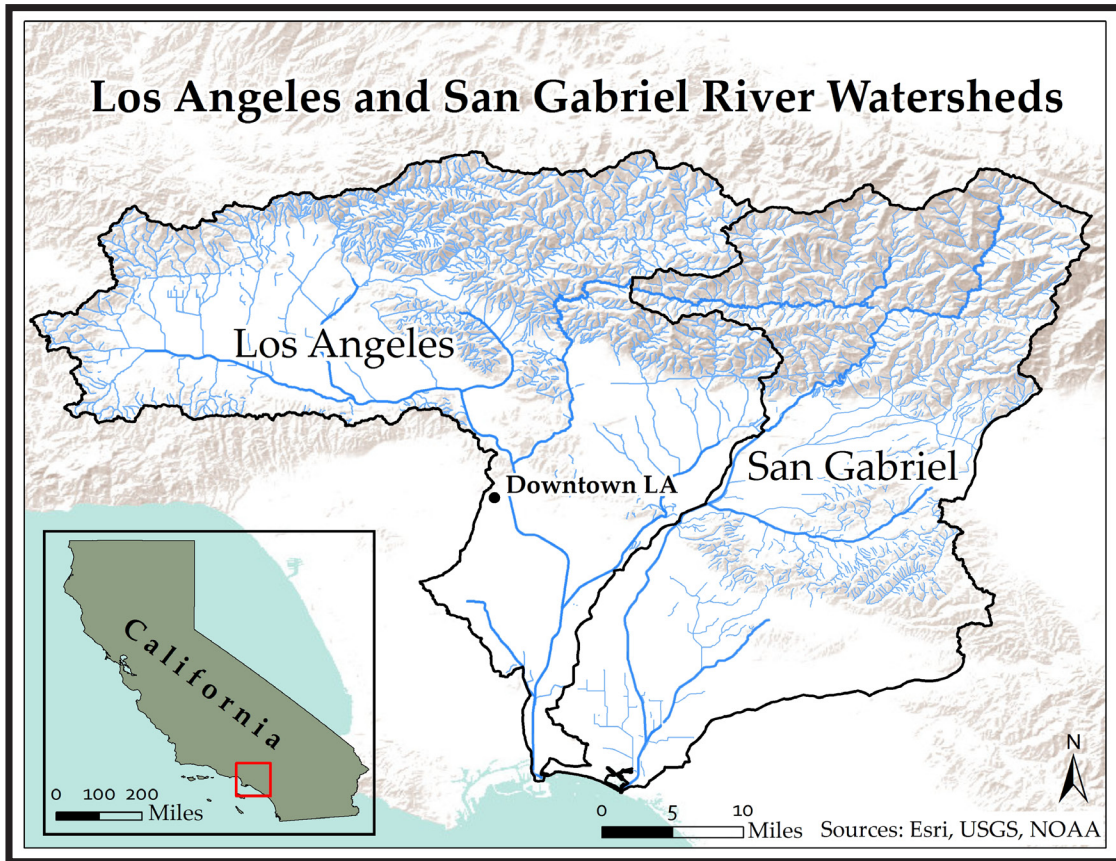

*Figure 3-1 Los Angeles and San Gabriel River Watersheds*

### 3.3.1 LOS ANGELES RIVER WATERSHED

The Los Angeles River Watershed (LA River Watershed) covers 824 square miles (Figure 3-1) (CRWQCB<sup>1</sup>, 2007). The headwaters for the LA River begin in the Santa Monica, Santa Susana, and San Gabriel Mountains. The mainstem of the river is 55 miles long. Although some of the headwaters are still in their natural state, nearly the entire river flows through concrete channels in heavily developed areas that empty into the ocean. The river's bottom and banks were covered by concrete in the early 1930s to mitigate the river's severe floods and local development that had encroached

well within the safe limits of the floodplain (Gumprecht, 1999).

The LA River Watershed has a relatively moderate Mediterranean climate, characterized by about 340 dry days and 25 wet days each year (City of LA<sup>1</sup>, 2006). The typical dry season is from June to October, and the wet season is from November through May. During the wet season, intense storms can swell the LA River as stormwater is quickly funneled off surrounding mountains and city streets into the concrete channel. Historically, most of the flow in the LA River would dry up towards the end of the

---

dry season. Today the LA River flows year-round, with about 65% of the dry-season flow coming from two tertiary-treated wastewater treatment plant discharges, the Donald C. Tillman Water Reclamation Plant and the Los Angeles-Glendale Reclamation Plant (Gumprecht, 1999). Another 30% of the dry-season flow comes from urban runoff through storm drains. The remaining 5% of water flow is from surfacing groundwater.

The dense urban cities that surround the LA River increase runoff that contains littered

trash. This runoff may be stormwater from the intense winter storms or from general water use during the dry season, such as landscape irrigation, street cleaning, and car washing. Both types of runoff can pick up litter that has accumulated on city streets and transport it to catch basins and then the LA River. Large winter storms are likely to transport litter in much greater quantities (Moore et al., n.d.; LARWQCB<sup>2</sup>, 2007). Furthermore, litter can be transported to the river via wind and direct dumping.

### 3.3.2 SAN GABRIEL RIVER WATERSHED

---

The San Gabriel River Watershed (SG River Watershed) covers approximately 689 square miles and occupies a large portion of eastern Los Angeles County, as well as a section of northwestern Orange County (Figure 3-1). It shares most of its western boundary with the adjacent LA River Watershed.

The headwater streams of the SG River Watershed originate in the San Gabriel Mountains. In this area, the streams maintain primarily native riparian habitat, with the exception of some areas that are set aside for recreational use (SWRCB, 2011). Due to its location near the coast and the effect of

rising topography as storms approach the San Gabriel Mountains, the SG River Watershed receives some of the heaviest rainfall in Southern California, with an average annual accumulation of 37.8 inches. This rainfall ultimately drains into the watershed's main channel, the San Gabriel River (SG River).

Due to its geologic makeup, the SG River has high sediment yields and can generate voluminous debris flows after rain events (Stein et al., 2007). To cope with this, a series of four dams were built to control the flow of water and sediment. There is little urban development above the dams; immediately

The Los Angeles River  
Photo: Michael Mori





---

below them, the SG River runs through a network of spreading grounds that are used to recharge groundwater. The main tributary from the west is the Rio Hondo; from the east, the SG River is fed by Walnut Creek in the northern reaches, San Jose Creek in the middle reaches, and Coyote Creek in the southern reaches. A majority of the upper region of the SG River has a natural riverbed, but this is transformed into a cemented channel in the lower watershed where there is a higher population density.

Most of the undisturbed land is predominantly in the upper watershed, whereas most of the industrial and urban uses are found in the lower end of the watershed. In this region, the SG River has been transformed into a trapezoidal concrete channel. The majority of land use is high-density residential, followed by industrial. According to a survey done in 2005 by Weston Solutions Inc., approximately 18% of the watershed is reserved for commercial, industrial, and transportation land uses, while 30% is used for residential purposes (WSI, 2011).

## 3.4 CURRENT POLICY

---

The issue of plastic debris in the environment has increasingly garnered the attention of policymakers over the past few decades. For example, disposing of trash at sea was once thought to be an acceptable practice. More recently, however, global, federal, state, and local agencies, as well as the plastics industry, have all acknowledged that

marine debris poses a substantial threat to ecosystems and to human health. A variety of legislation (global ocean treaties, federal water laws, regional pollution limits) have been implemented at multiple levels of government to reduce the amount of this debris entering the ocean and make those responsible liable for cleanup and mitigation.

### 3.4.1 GLOBAL

---

Over the past 40 years, there has been more focus on reducing litter in global policy. Current policy aims to reduce discharges of litter from ships into the ocean, but its effectiveness has been questioned due to the difficulty of enforcing pollution laws in international waters (Ellis, 1998; Kirkley et al., 1997). To date, no comprehensive global land-based litter policies have been implemented.

The MARPOL Treaty of 1973 imposed a complete ban on plastics (and other types of trash) from entering the ocean via ship garbage disposal within a certain distance

from the shore (before this, it was legal for ships to dump all of their waste into the ocean) (Conner, 1988; Ellis, 1998; IMO, n.d.). The Coast Guard enforces the treaty in U.S. coastal waters, with a fine of up to \$25,000 for non-compliance (Conner, 1988). One early study on the effectiveness of this treaty found that trawl waste was reduced on beaches in Alaska since the ratification of the law (Johnson, 1994). Other studies, however, have not found a decrease in waste or a decrease in marine impacts (Thompson et al., 2004), bringing to question its effectiveness (Santos et al., 2005).

---

### 3.4.2 FEDERAL

The main federal policy governing marine trash is the Marine Protection, Research and Sanctuaries Act (commonly referred to as the Ocean Dumping Act) that was enacted by Congress in 1972 (EPA, 2013). This law requires regulation of all ocean dumping and the creation of marine sanctuary regions where dumping is prohibited. The Ocean Dumping Act includes sections on prevention and removal of marine debris in order to reduce negative impacts on both marine life and navigational safety. These sections also include provisions for marine debris mapping,

impact assessments, and removal efforts focused on areas of major threat.

The main federal policy governing terrestrial trash is the Clean Water Act, in which the U.S. government takes the position that discharging pollutants (such as plastic debris) into waterways is a privilege, not a right. Section 402 of the Clean Water Act (1972) established the National Pollutant Discharge Elimination System (NPDES) and gave the Environmental Protection Agency (EPA) the authority to issue federal discharge permits. In California, the NPDES permit program is administered at the state level (EPA, 2009).

### 3.4.3 CALIFORNIA

California has enacted various laws to reduce plastic debris entering the marine environment, such as the Porter-Cologne Act and Assembly Bill 258 (AB 258). The Porter-Cologne act is similar to the Clean Water Act and gives regulatory power to the California State Water Resources Control Board (State Water Board) and California's nine Regional Water Quality Control Boards (Regional Water Boards). This includes the Los Angeles Regional Water Quality Control Board

(LARWQCB), which has jurisdiction over the Los Angeles River Watershed and most of the San Gabriel River Watershed. With the additional enforcement power of the Clean Water Act, State and Regional Water Boards use policies such as NPDES permits and Total Maximum Daily Loads (TMDLs) to manage or reduce the flow plastic debris into California's waterways. NPDES permits, TMDLs, and AB 258 are further analyzed in our findings and recommendations.

## 3.5 SIMILAR RESEARCH

This project represents one of the first approaches to enhancing the understanding of the plastic debris problem on a regional to local level. Most of the previous and

current research into plastic debris has been conducted at the state or global level. Some of the more relevant of these studies or reports include:



- 
- **Marine Litter: An Analytical Overview** (UNEP, 2005). Based on an analytical review, this study proposes a suite of global and regional actions that should be taken to address the plastic debris problem.
  - **Plastic Debris in the Ocean** (Kershaw et al., 2011). An overview of the current state of global scientific research into the impacts and sources of smaller fragments of plastic debris; recommends actions to manage the problem.
  - **Marine Debris Strategy for the West Coast Governors' Alliance on Ocean Health** (WCGA, 2013). A collective tri-state effort by the governors of California, Oregon, and Washington to address the problem of plastic debris in the ocean through multiple collaborative efforts.
  - **Plastic Debris in the California Marine Ecosystem: A Summary of Current Research, Solution Strategies and Data Gaps** (Stevenson, 2011). This report is an overview of current California research and policies relating to efforts to reduce the amount of plastic debris entering the environment.
  - **Eliminating Land-Based Discharges of Marine Debris in California: A Plan of Action from the Plastic Debris Project** (Gordon, 2006). The culmination of the "Plastic Debris: Rivers to Sea" project, this report focused on California land-based discharges of plastic; the findings of the report parallel many of our findings.

Plastic bag in the Coyote Creek channel

Photo: Michael Mori



---

## 4 METHODS

---

Given the broad scope of our project, multiple methods were used to collect and analyze information and data related to plastic debris. Interviews with more than 60 professionals with knowledge of plastic debris and/or policy were conducted, and an extensive literature review (over 300 articles and reports) related to the current knowledge of the issue was completed. To complement this information, we visited both the Los Angeles and San Gabriel River Watersheds

and a plastic production facility to enhance our understanding of plastic debris in the waterways. Data on plastic debris quantity and characterization was collected from government and nongovernment agencies. The data we obtained were then analyzed using various methods, which are discussed in greater detail later in this report. Finally, all of the previous research and findings were synthesized into policy recommendations, ranked by feasibility and effectiveness.

### 4.1 INTERVIEWS

---

We conducted more than 60 interviews with federal, state, regional, and local agencies. Many of our contacts worked for government agencies, such as the EPA, the Los Angeles Regional Water Quality Control Board, the State Water Resources Control Board, and the City of Los Angeles. Other organizations we contacted included research and/or advocacy groups, such as the Southern California Coastal Water Research Project and LA Waterkeeper. The majority of these interviews were conducted by phone. These interviews helped to inform our site visits, literature review, conceptual model, data analyses, and policy recommendations. A complete list of contacts is provided in Appendix G .

Each interviewee was contacted because the individual was identified as having knowledge and/or familiarity with plastic debris issues. The questions we asked were tailored to specific topics of concern and to the person's role in dealing with plastic debris. For example, state regulators were asked about specific language in stormwater permits and their view on inspections, while city personnel were asked about how they enforced regulations and any difficulties they had with the process. Where available, raw data on the quantity and characterization of plastic debris in the LA and SG River Watersheds were obtained.

### 4.2 LITERATURE REVIEW

---

A comprehensive literature review on plastic debris was conducted from March 2012 to December 2013. More than 300 peer-reviewed journal articles, reports, white papers, presentations, and media reports

were reviewed. A wide breadth of information on plastic debris was considered: the history of plastic debris; the sources and transport on a global, regional, and local level; the regulatory framework on a global, regional,



---

and local level; and the role of industry and wastewater treatment plants (WWTPs) with regard to microplastics.

These reports were gathered from a variety of sources, including internet searches, agency websites, and referrals from our client and contacts. Peer-reviewed scientific journal articles were accessed through University of California, Santa Barbara library resources and internet searches using terms such as “plastic debris,” “marine debris,” and “plastic debris policies.” Numerous articles identified through citations in papers were also

reviewed. Google’s search engine was used to find documents on regional regulatory mechanisms such as Total Maximum Daily Loads (TMDLs) and stormwater permits, as these are not included in the scientific literature. On occasion, relevant papers on plastic debris were sent to us from contacts made during interviews.

We compiled our research into a literature review (see Appendix C – Literature Review). This review helped guide the background, findings, and recommendation sections of our report.

### 4.3 SITE VISITS

---

To gain personal insight into the nature and extent of plastic debris in the LA and SG River Watersheds we visited more than a half dozen locations over the course of two site visits.

For our first site visit, we stopped at the Los Angeles River, San Gabriel River, and Coyote Creek (a major tributary of the San Gabriel River) to observe the environmental conditions. Photos and notes were taken on the presence and composition of plastic debris. A plastic facility in Orange County

was also visited to observe BMPs used when handling preproduction plastic.

A second site visit to the Los Angeles River was conducted to inspect plastic debris in outfalls to the river. In addition to taking photos on the presence and composition of plastic debris, samples of sediment from two outfalls to the river were collected in the City of Maywood. From this data, we recorded both the types and sizes of recovered debris.

### 4.4 CONCEPTUAL MODEL

---

A conceptual model was developed to synthesize our understanding of the impacts, sources, methods of disposal, and transport of plastic debris into a visual aid.

This conceptual model helped to guide our subsequent data analyses and policy recommendations.

### 4.5 DATA ANALYSES

---

Data were collected from governmental agencies, research institutions, and nonprofit

organizations (see Appendix H – Data Index). These data were then analyzed to assess



---

multiple facets of the issue of plastic debris: quantity, characterization, TMDL compliance, the role of plastic manufacturers, and emissions of microplastics from wastewater treatment plants. These facets were analyzed because they played an integral role in the issue of plastic debris in the watersheds. For some of the trash collection data, statistical

analyses were performed. However, much of the data did not permit robust analysis – the interpretation of most of the data was from compilation. Further details on our data analyses can be found in the “Assessing the Quantity And Characterization of Plastic Debris in the Watersheds” Findings section.

## 4.6 POLICY RECOMMENDATIONS

---

We first generated a list of policy recommendations based upon our collective knowledge garnered over the course of this project from the literature review, interviews, site visits, and data analyses. These policies were then prioritized into tiers of importance, using two criteria: feasibility of implementation and effectiveness at reducing plastic debris. Both political and

economic factors were considered when ranking for feasibility. The strongest indicator of effectiveness was evidence that similar policies elsewhere had effectively reduced plastic debris. These recommendations represent the crux of our project; our methods for identifying these action items are discussed in detail in the “Recommended Actions to Reduce Plastic Debris” section.



Plastic takeout container  
in the San Gabriel River  
Photo: Bill Vosti

---

# 5 FINDINGS

---

## 5.1 GENERAL

---

### 5.1.1 THE MAGNITUDE OF PLASTIC DEBRIS IS WELL UNDERSTOOD

---

Plastic production has been on the rise since its development in the early 1900s (Plastics Europe, 2013). The resilient properties of plastic allow it to persist for a long time (tens to hundreds of years) in the environment (Andrady, 1988; Kershaw et al., 2011). Most

plastic does not completely decompose, but instead breaks down into smaller pieces. The manufacture and sale of new plastic products maintains a steady stream of plastic that has the potential to enter the environment.

#### PRODUCTION

---

Global plastic production has increased by an average of 5% per year over the past 20 years. From 2010 to 2012, the amount of plastic produced increased from 265 million tons to about 280 million tons (Plastics Europe, 2013; UNEP, n.d.). In the U.S. alone, 32 million tons of plastic were produced in 2011. Packaging was the largest component of plastic production, producing over 12 million tons of plastic annually. Consumer products were the second largest category of plastic production,

making up another 7 million tons (ACC, 2013, EPA, 2013). Large quantities (about 7 million tons) of plastics are also produced annually in the U.S. for exportation. Exports are mainly shipped to Mexico, Canada and Latin America and consist primarily of polyvinyl chloride (PVC), high-density polyethylene (HDPE), and low-density polyethylene (LDPE). In 2012, the export of plastics was an \$87 billion industry that is expected to continue to grow in coming years (ACC, 2013).

#### WASTE

---

Plastic waste generation is centered in urbanized areas and is the third largest constituent of the waste stream on a global scale, following only food and paper waste. Between 1980 and 2000, the percentage of the municipal waste stream in the U.S. that is plastic had more than doubled. It now makes up nearly 13% of the national municipal waste stream (EPA, 2013).

California's waste stream consisted of over 9% plastic by weight in 2003 and contributed about 3.8 million tons. During this time, plastic films were the most abundant,

followed by durable plastic items, plastic trash bags, and industrial packaging films (IMWB, 2004). These plastic films account for between 8% and 10% of the waste stream by volume (CalRecycle, 2011).

While the municipal waste stream is usually not a contributor to plastic debris to the environment (at least in areas with modern landfill operations), these statistics provide an idea of the percentage of litter that is likely plastic and which types are most common.

---

## RECYCLING

---

In comparison to other regions around the world, the U.S.'s plastic recycling rate is relatively low. Europe's plastic waste was recycled at a rate of 26% in 2012 (Plastics Europe, 2013) while the U.S. only reported an 8% recycling rate in 2011 (EPA, 2013). Approximately 11% of plastic films (such as bags, sacks, and wraps) were recycled in the U.S. in 2011. Recycling rates for polyethylene terephthalate (PET) and HDPE were 29% (EPA, 2013). Current recycling rates have

not resulted in a substantial reduction in the plastic waste stream (CalRecycle, 2010).

In California, the recycling rate for plastic is only about 5%. The most commonly recycled plastic is PET, used to make items such as bottles, egg cartons, and fibers (CalRecycle, 2011). These rates may be due to California's Redemption Value program which allows individuals to receive money for turning in select recyclable products (e.g., bottles).

---

## ACCUMULATION IN THE MARINE ENVIRONMENT

---

The accumulation of plastic in the ocean often concentrates around gyres (Figure 5-1), which are specific regions where oceanic currents converge. These gyres have been

documented in many regions of the world's oceans and have become a focus of numerous marine studies to document the accumulation of floating plastic debris (NOAA, 2012).

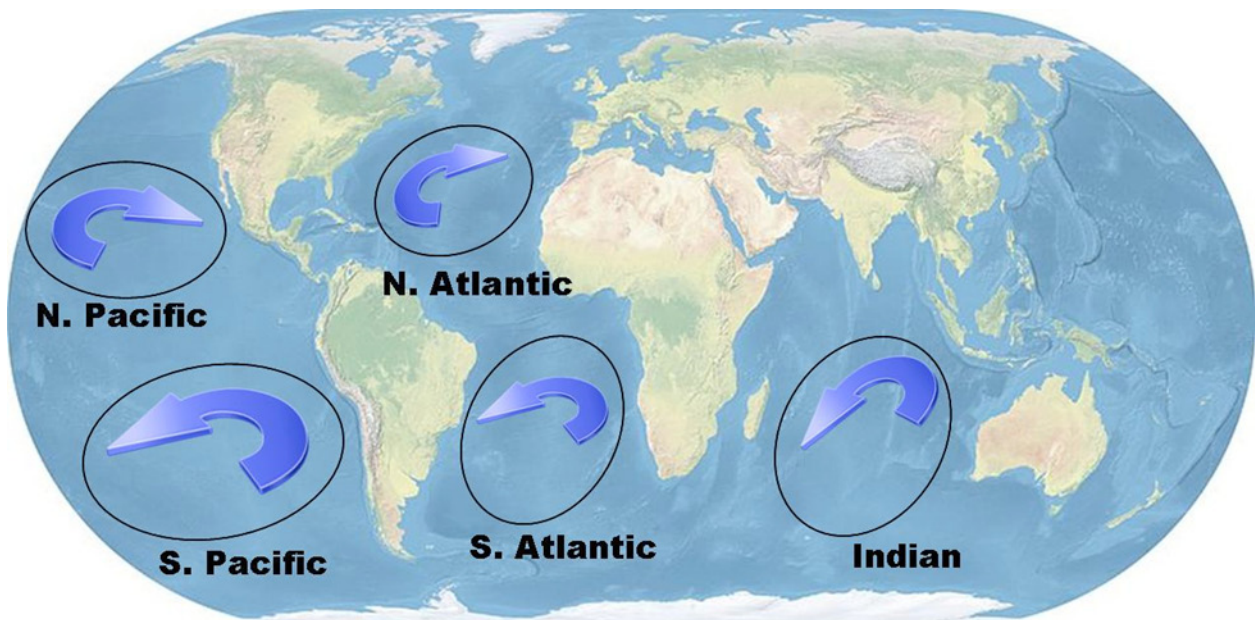

*Figure 5-1 The five subtropical gyres around the world (AMRI, 2013).*

A brief summary of the current state of knowledge related to the accumulation and characterization of plastic debris in these gyres is outlined below:



- **North Pacific Subtropical Gyre (commonly called the Great Pacific Garbage Patch).** Plastic debris that transports to this gyre accumulates and is likely to remain there. The true size and mass of the trash in the gyre is unknown, given that less research has been done here than in many of the others (NOAA, 2013).
- **North Atlantic Subtropical Gyre.** The synthesis of 22 years of surveys to assess the density of plastic debris accumulating in this gyre yielded a maximum density of 580,000 pieces per square kilometer (Law et al., 2010). It has been estimated that 88% of plastic material found in this gyre was smaller than 10 mm long (nearly half the size of what was found in the 1990s), implying progressive degradation of plastic in the marine environment (Moret-Ferguson et al., 2010).
- **South Atlantic Gyre.** Studies have yielded findings of between 1,300 to 3,600 plastic pellets per square kilometer (Morris, 1980; Barnes et al., 2005).
- **Indian Ocean, the Bay of Bengal, and the Straits of Malacca.** Studies have revealed 18,000 counts of debris, with 98% of them being plastic, in over 3,275 km of transects (Ryan, 2013).
- **Western North Atlantic.** A recent study showed a stabilizing concentration of plastic debris (Law et al., 2010). One speculation is that the rate of plastic entering oceanic gyres is now being matched by the rate that plastic is sinking from the surface, given that as plastic remains in the ocean and breaks down, it becomes more dense and thus more apt to diffuse throughout the water column.

## 5.1.2 THE IMPACTS OF PLASTIC DEBRIS ARE WELL UNDERSTOOD

As plastic debris continues to litter beaches and circulate in the ocean, its presence and damaging effects on biological, ecological, and economic systems are becoming more apparent. In the following section, we

examine the impacts of plastic debris on river, beach, and ocean systems, and human health. Furthermore, we also discuss the economic costs of plastic debris through litter control, cleanup, and decreased tourism.

### RIVER AND ESTUARY POLLUTION

Many rivers in urban regions no longer meander, periodically flood, and support complex ecosystems of birds, fish, and mammals, but instead are channelized to aid in flood protection. As is the case for the Los Angeles and San Gabriel River Watersheds (LA and SG River Watersheds), much of the water in urban rivers now comes from stormwater runoff, wastewater, and industrial effluent.

Trash generated from humans, if littered, can be washed or blown into storm drain catch basins. Catch basins may have grates or inserts inside that prevent litter greater than 5 mm from passing through. However, in many locations, these catch basins have no coverings, and in open spaces without concrete channels, litter flows directly into nearby streams. Without storm drain inserts, litter of all sizes can enter the waterways,

---

eventually making its way to highly critical zones such as estuaries and marshes where it can flow unhindered until stopped by vegetation or washed out to sea. Due to the shallow and highly vegetated nature of

estuaries, litter can easily become trapped where it may settle to the stream bed and affect gas exchange and circulation patterns in these highly biologically productive ecosystems (Long, 1996).

## BEACHES

---

Direct litter by beachgoers, river outlets, and ocean currents are all sources of trash on beaches. Plastic litter has been linked to a loss of tourism, which economically harms local businesses, such as restaurants, fishing communities, and tourist shops, and decreases property values. With a large population living near the coast (77% of California's population in 2010), and with the fastest growing populations occurring in near-shore communities, coastal degradation from plastic debris can have large economic impacts that are felt by the entire state (NOEP, 2005).

The number of organizations and volunteers that participate in beach cleanups is evidence of the importance of clean beaches. During the past 20 years, the Ocean Conservancy has helped to organize over 6 million volunteers from 100 countries to remove more than

100 million pounds of trash from 170,000 miles of beach and inland regions (Moore, 2008; OC, 2011). While beach cleanup efforts are effective at removing large debris items and educating the public, people are only capable of removing items they can easily see. Smaller types of plastic, such as preproduction plastic pellets, microbeads, microfibers, and small plastic fragments are difficult to detect and remove.

### **Over the past 20 years, the Ocean Conservancy has organized:**

- **Over 6 million volunteers**
- **From 100 countries**
- **Removed more than 100 million pounds of trash**

## OCEANS

---

*"The very survival of the human species depends upon the maintenance of an ocean clean and alive, spreading all around the world. The ocean is our planet's life belt."*

- Jacques-Yves Cousteau (1980)

Due to the lightweight and non-biodegradable nature of plastics, they can either float or sink depending on the type

of monomer or how it was formed. The very properties that make plastics convenient to humans are what make them such a threat to the ocean. Versatility, durability, and persistence in the environment cause plastic debris to impact nearly every marine ecosystem.

Once plastics reach the ocean, they are easily transported by ocean currents,

---

deposited on beaches, or trapped in gyres where they have been estimated to persist for tens to hundreds of years depending on their chemical composition (Andrady, 1988; Freinkel, 2011; Kershaw et al., 2011; Law et al., 2010; Shaw et al., 1994).

Gradually, through wave action, photo-degradation, oxidation, and hydrolysis, large pieces of plastic will break down into smaller

microplastics. These smaller pieces present a new host of issues, including adverse effects on marine life that have been documented, but have proven difficult to quantify. Once in the ocean, plastics can be ingested by marine species, entangle biota, assist in the spread of invasive species, leach harmful chemicals, and may build up as sediment on the marine floor (Ng et al., 2006; Thompson et al., 2004).

## WILDLIFE

---

Plastics cause severe harm to animals, especially marine wildlife such as seabirds, fish, and marine mammals, through biotic consumption, entanglement, modification

to benthic habitats, the spread of invasive species, and the transfer of chemicals to animal tissues.

### *Biotic Consumption*

Based on the variability of plastics' buoyancy, it is suspected that animals forage on plastics in both the benthic (bottom of a water body) and the pelagic (water column) zones. Thus, nearly all aquatic species can be affected by its presence. Nearly 40 peer-reviewed studies have correlated plastic ingestion to increased marine species mortality. It is believed (but not yet proven) that multiple species of turtles, fish, mammals, birds, and invertebrates have died due to plastic ingestion (Allsopp et al., 2006; Auman et al., 2004; Baird, 2000; Barnes et al., 2009; Blight et al., 1997; Boerger et al., 2010; Bond et al., 2013; Bourne et al., 1982; Browne,

2008; Bugoni et al., 2001; Buxton et al., 2013; Campani et al., 2013; Carr, 1987; Carson et al., 2013; Colabuono et al., 2009; Connors and Smith, 1982; Eriksson and Burton, 2003; Graham and Thompson, 2009; Gregory, 2009; Ivar do Sul et al., 2013; Jacobsen et al., 2010; Kershaw et al., 2011; Laist, 1987; Moser and Lee, 1992; Murray et al., 2011; Petry et al., 2009; Provencher et al., 2010; Robards et al., 1995; Rodriguez et al., 2013; Ryan 2008; Sazima et al., 2002; Schulyer et al., 2013; Stamper et al., 2006; Stevenson, 2011; Teuten et al., 2007; Tourhino et al., 2010; Van Franeker, 1988).

### *Entanglement*

Animals can swim into plastic litter looking for food or shelter and become entrapped. Thin plastics, such as bags and plastic wrapping, can become pressed against the face or gills of swimming animals and lead to suffocation.

If entangled, animals may become less effective at foraging and predator avoidance, decreasing their likelihood of survival. The main causes of animal entanglement have been shown to be from derelict fishing gear



---

(referred to as ghost fishing), bags, balloons, caps, straws, and six-pack rings (Ocean Conservancy (OC) International Coastal Cleanup Report, 2010; Carr, 1987; Gregory, 2009; Jacobsen et al., 2010; Kershaw et al.,

2011; Rodriguez et al., 2013; Stevenson, 2011; UNEP 2006; Waluda et al., 2013; Barnes et al., 2009; Gregory 2009; Derraik, 2002; Laist, 1987, Stevenson, 2011).

### *Benthic Life*

It is not just plastic debris floating in the water column that is of concern – plastics settlement on the seafloor may have associated impacts as well (Gregory, 2009). While most plastics are initially buoyant, after degradation some can sink. A study in Tokyo Bay found that 80%-85% of the seabed debris was plastic, suggesting that as plastic breaks down it loses its buoyant properties (Derraik, 2002). Plastic debris on the seabed can prevent crucial processes, such as gas

exchange between water and the sea floor, resulting in hypoxia (oxygen deficiency) and reduction in other essential ecosystem functions (Goldberg, 1997). This change in benthic ecology has the potential to alter the number of species that are able to reside in that habitat. Additionally, plastic on the sea floor opens up the possibility of accidental consumption of plastic to bottom dwelling species (Goldberg, 1997).

### *Transport Mechanisms – Spread of Invasive Species*

The durability of plastic marine debris is creating a new vector for invasive species travel (Allsopp et al., 2006; Barnes et al., 2002; Hinojosa et al., 2011; Kershaw et al., 2011). Species such as bryozoans, barnacles, polychaete worms, hydroids, coralline algae, and mollusks have been observed settling on plastic debris and being transported to new regions by ocean currents (Allsopp, et al., 2006; Barnes et al., 2002, 2004; Gregory, 2009). Once in new locations these organisms (typically hardier, due to their ability to survive in novel environments) may colonize and pose the threat of outcompeting native species.

Furthermore, the hydrophobic (water-repellent) nature of plastics makes them a good environment for colonization and subsequent growth of microbes. This collection of microbial heterotrophs, autotrophs, predators, and symbionts, now referred to as the “plastisphere,” may facilitate transportation beyond normal ranges. Once in new locations, these microbes may have the potential to spread dangerous diseases or pathogens (Zettler et al., 2013).

---

## DEGRADATION AND CHEMICAL LEACHING

---

Plastics in use today are made from a wide variety of polymers combined with many types of plasticizers, dyes, and other chemicals. In certain environments, chemicals have been known to leach out of the plastics that once contained them, freeing endocrine disruptors and carcinogens to the environment (EC, 2013; Saïdo et al., 2009).

In contrast, as plastics degrade they may become more likely to attract (sorb) contaminants floating in the ocean, transporting these toxins up the food chain. The physical characteristics of plastics – hydrophobic, low polarity, and high porosity – increases the affinity of chemicals and toxins to bind to them (Bakir et al., 2012; Frias et al., 2011; Hirai et al., 2011; Stevenson, 2011; Mato et al., 2001). Plastics may be

**Recent studies show that plastics floating in the marine environment may collect toxins and serve as transport mechanisms up the food chain**

collecting and transporting many types of toxins: persistent organic pollutants (POPs), polychlorinated biphenyls (PCBs), polycyclic aromatic hydrocarbons (PAHs), dichlorodiphenyl trichloroethane (DDTs), and other organic pesticides (Fisner et al., 2013; Teuten et al., 2009; Rios, 2007; Mato et al., 2001). Chemicals, such as DDT, that are already floating freely in the marine environment, may sorb to plastic fragments. Sorption can be so strong that chemicals detected on plastics have been found up to six orders of magnitude higher than their concentration in the surrounding waters (Rochman et al., 2013). Once sorbed to plastics pieces, greater amounts of toxins may be transported up the food chain from the species that consume them (Carson et al., 2013; Rochman et al., 2013).

---

## HUMAN HEALTH

---

The first study to show the dangers of plastics was published in 1969. Two toxicologists at John Hopkins University discovered that phthalate ester plasticizers were found in rat's blood after they received blood transfusions

containing plastic particles, (Jaeger, 1970). Since then, additional research has identified other potential human health issues associated with the materials used in plastic production.

*Plastic chemical additives such as biphenyl A (BPA) and phthalates can lead to hormonal disruption in humans and animals*

- **Bisphenol A (BPA)** is used as an epoxy resin to line canned foods and drinks, and is also a primary component of polycarbonate, a clear hard plastic, commonly used to make bottles and eyeglass lenses (Wargo et al., 2008). While it is known that BPA can leach from plastic materials and has been found in human blood samples, further research is needed to examine how severe the effects of BPA may be (Kershaw et al., 2011; Wargo et al. 2008).
- **Polychlorinated biphenyl (PCBs)** are common in marine food webs (Porta et al., 2002). It was once commonly used as a plasticizer, but is now illegal. Even after phasing this chemical out of products, older discarded plastics containing PCBs can still be found in the ocean. High concentrations of PCBs can lead to neurological, hormonal, immunological, and cancer problems, as well as reproductive disorders, increased risk of disease, and death, but its effects in marine systems are not yet fully understood (Porta et al., 2002; Mato et al., 2001).
- **Phthalates** are commonly used to make plastics soft and pliable. One of these phthalates, di (2-ethylhexyl) phthalate (DEHP) has been the subject of much concern. DEHP can be found in shower curtains, raingear, upholstery, dashboards, and children’s toys, as well as intravenous bags and tubing. Researchers suspect DEHP may be partially responsible for increased rates of cancer, reproductive issues in women, and lower sperm count in males (Kershaw et al., 2011; NPR interview with Mark Shapiro, June 17, 2011; Wargo, 2008). While still allowed in the U.S., these products have been deemed dangerous enough that the European Union has outlawed them (Wargo, 2008).

### 5.1.3 THE SOURCES OF PLASTIC DEBRIS ARE WELL UNDERSTOOD

Plastic sources are broadly categorized as either land- or ocean-based (Gordon, 2006; Kershaw et al., 2011; NOAA, 2008; Stevenson, 2011). The National Marine Debris Monitoring Program, developed by the Ocean Conservancy with the support of the EPA, determined that 49% of all debris found on beaches came from land-based sources, with no significant change in the volume over the five-year study period (Sheavly, 2007). An additional 33% was estimated to have come from either land- or ocean-based sources because the exact source could not be assessed (Sheavly, 2007). Plastics have consistently made up the majority (between 60-80%) of marine debris over the past couple of decades (Keller et al., 2010; Kershaw et

al., 2011; Ribic et al., 2012; UNEP, 2011; WSI, 2011).

The focus of this report will be on land-based sources, which have been broadly broken out into six general categories (Allsopp et al., 2006; Gordon, 2006; Sheavly, 2007; WSI, 2011): litter, stormwater discharge, industry, storm events, transport of litter, and municipal landfills.

We have also added a seventh category to this generally accepted list – wastewater treatment plants, due to emerging concern over microplastics, microbeads, and microfibers entering the marine environment through these systems.



---

Land-based sources are variously estimated by different studies to constitute between 50-80% of all marine debris worldwide (Allsopp et al., 2006; Gordon, 2006; Ribic et al., 2012; Sheavly, 2007; Stevenson, 2011; WCGA, 2013; WSI, 2011).

Population size has been correlated with land-based contributions of plastic debris – regions with larger populations tend to have higher debris loads (Barnes, 2005; Ribic et al., 2012; Stevenson, 2011). Land use has also been correlated with plastic debris sources (Gordon, 2006; Moore, 2005). Commercial land use is consistently associated with higher loads of debris of all kinds when compared with residential and mixed land uses (Gordon, 2006; Moore, 2005).

The most commonly identified source of plastic debris is single-use packaging (Stevenson, 2011; WSI, 2011). A comprehensive study conducted in 2011 found that approximately 50% of all plastics are manufactured into single-use disposable packaging (Stevenson, 2011). The Ocean Conservancy-sponsored beach cleanups

ranked the abundance of these single-use items in the top ten most common debris items: cigarette butts and filters; plastic beverage bottles; plastic bags; plastic caps/lids; plastic food wrappers and containers; plastic cups, plates, forks, knives and spoons; glass beverage bottles; plastic straws and stirrers; beverage cans; and paper bags (Ocean Conservancy, 2011).

Until recently, many source identification efforts came from the characterization of trash collected at cleanup events conducted primarily along beaches, rivers, and in other recreational areas. Due to their small size, microplastics likely went unnoticed. Recent efforts have sought to fill this information gap by designing surveys that incorporate protocols for identifying microplastics. In one such study, preproduction plastic pellets, foam plastics, and rigid plastics were identified as common plastic debris found on Southern California beaches (Moore et al., 2001). All of these items are either initially small in size (preproduction plastic pellets), or easily break down in the environment (foam and rigid plastics).

## LITTER

---

Trash that is improperly disposed of has the potential to end up on streets, in stormwater systems, and in waterways (EPA, 2013; NOAA, 2008). Besides illegal disposal (littering), improper disposal can occur where there is a lack of infrastructure to capture plastic debris such as trash cans without lids, overfilled trash cans at events, public parks, recreational areas, and beaches (Ocean Conservancy, 2011).

There are some studies that provide accurate quantitative measurements for trash released accidentally into the environment, but until very recently plastic debris has not been broken out as a separate component, making source identification and quantification problematic (Stevenson, 2011; UNEP, 2011).

Urban runoff has been identified as a primary source of marine debris (Gordon, 2006). The primary source of trash in urban runoff is

---

judged to be litter (Gordon, 2006). Litter that is not picked up through street sweeping, voluntary cleanups, and catch basin systems has the potential to end up in rivers and make its way to the ocean. For example, of the trash collected and analyzed by Caltrans, moldable plastics represented the largest component by volume and cigarette butts represented the largest category by count; however, identifying the source of the trash was not possible due to the small sizes of the majority of pieces collected (Lippner et al., 2001).

A 2011 Friends of the Los Angeles River trash cleanup effort (Tyack, 2011) found plastic film (primarily single-use plastic bags and snack and candy wrappers) to be the most abundant item. Single-use plastic food packaging and polystyrene were also in the top five categories found.

A 2012 study at the Fullerton Creek Watershed in Orange County found that 48% of all trash collected over a four month period was plastic (Furman, 2013). The largest accumulation of debris (38% of the total debris collected) occurred in a monitoring site in close proximity to a freeway and homeless encampment (Furman, 2013).

## STORMWATER DISCHARGE

---

On a regional level, 43% of the litter trapped in California storm drains by catchment inserts was plastic (CDOT, 2011). This is a strong indication of the transport of plastics from the land to the ocean via waterways. Stormwater systems are prohibited by law from discharging plastics into waterways to the maximum extent practicable; however, during storm events excessive rainfall may exceed their capacity, resulting in accidental discharges (NOAA, 2008; Sheavly, 2007; WSI, 2011).

The Los Angeles Regional Water Quality Control Board (LARWQCB) limits the

maximum amount of trash that can enter a water body through a municipal stormwater system with Trash Total Daily Maximum Loads (Trash TMDLs). To comply with the Trash TMDL in the Los Angeles River Watershed, thousands of catchment inserts have been installed that have mesh screens that capture any object 5 mm or greater in size, so theoretically the amount of plastics entering the waterways through storm drains has been reduced (LARWQCB, 2007). Trash TMDLs are discussed further in the “Zero Trash TMDLs are Hit or Miss” Findings section.

## INDUSTRY AND MANUFACTURING

---

It is currently estimated that one-third of total annual global plastic production is dedicated to packaging, another one-third to construction materials, and the remaining one-third to a mixture of uses ranging from automobiles to toy and furniture products

(Andrady et al., 2009; Lebreton et al., 2012; Plastics Europe, 2012; Thompson et al., 2009). The U.S. plastics industry reports that packaging represented 42% of total production in 2012 (ACC, 2013).

---

Industry and manufacturing processes involve the use of raw materials in the forms of plastic resins, powders, and preproduction pellets. Plastic pellets (commonly called nurdles or preproduction pellets) are the raw materials used to form or mold plastics for a multitude of commercial products (Arthur et

al., 2008; Barnes et al., 2009; Derraik, 2002; McDermid et al., 2004). Preproduction pellets are thought to enter the environment mainly through accidental spills during transport or handling (Arthur et al., 2008; Derraik, 2002; EPA, 1993; Moore, 2013).

## STORM EVENTS

---

Storm events, such as hurricanes, tornadoes, floods, and tsunamis can cause the accidental release of large volumes of plastic debris from land-based sources to the ocean (NOAA, 2008). One storm event in the Los Angeles region during 1997 released 13 metric tons of debris from Ballona Creek into the Santa Monica Bay (CDOT, 2011). This debris would

have included sediment and vegetation, along with trash, but based on a trash characterization study conducted by the LARWQCB, it is likely that approximately 9% was trash – and somewhere between 50-80% of the trash was composed of plastic (Noyes et al., 2004).

## TRANSPORT OF LITTER AND WASTE

---

Land-based sources of plastic debris can be transported by the wind or washed out to the ocean by rivers (Allsopp et al., 2006; Gordon, 2006; NOAA, 2008). Plastic, due to its lightweight characteristics, has the potential to be blown from one place to another, making quantification difficult. Our review of more than 300 peer-reviewed journal articles, agency white papers, and other reports, did not yield any indication of attempts to quantify wind transport as a source of plastic debris.

Plastic can also enter the environment during transport to landfills if trucks are not adequately designed to contain their haul (NOAA, 2008; WSI, 2011). Accidental spills can also occur at trash collection points (NOAA, 2008; WSI, 2011). Los Angeles County landfill operators estimate they spend approximately annually per landfill to gather single-use bags that are lost during collection, transport, or at the facilities, despite their implementation of BMPs such as truck covers and fencing at facilities (COLA, 2007).

## MUNICIPAL LANDFILLS

---

Approximately 10% of the waste stream in the U.S. is composed of plastic (Barnes et al., 2009; Cole et al., 2011; Derraik, 2002; WSI, 2011). According to the EPA, plastics as part of the municipal solid waste system increased from 1% in 1960 to nearly 13%

in 2011 (WSI, 2011). The most abundant category was containers and packaging (WSI, 2011). In California, a study conducted by the California Integrated Waste Management Board in 2004 and 2008 ranked plastics as the second-largest category of waste entering



---

landfills, just behind paper items (Stevenson, 2011). The study also revealed that packaging represented 23% of the total plastic entering

landfills, and 13% was plastic grocery and trash bags (Kershaw et al., 2011; Stevenson, 2011).

## WASTEWATER TREATMENT PLANTS

---

Microplastics have multiple sources: plastic scrubbers used in facial cleansers and cosmetics (microbeads), industrial processes where microparticles are blasted at machinery to remove rust or paint, fibers from the laundering of synthetic fabrics containing plastic materials (microfibers), and the breakdown of larger plastic particles after they enter the environment (Arthur et al., 2008; Browne et al., 2011; Cole et al., 2011; Derraik, 2002; Fendall et al., 2009; Thompson et al., 2004).

Many wastewater treatment plants (WWTPs) discharge their treated waters into rivers, and those discharges can include microbeads and microfibers. According to Browne et al. (2011), tertiary treatment conducted by WWTPs does not remove all microplastics – ultrafiltration systems would be needed to accomplish this. Interviews with wastewater treatment plant managers in the study region about microbeads and microfibers are discussed further in the “Microplastics are an Emerging Type of Plastic Debris” Findings section.

## 5.2 LOS ANGELES AND SAN GABRIEL RIVER WATERSHEDS

---

### 5.2.1 THE TRANSPORT OF PLASTIC DEBRIS IN THE WATERSHEDS ARE WELL UNDERSTOOD

---

Through our literature review and interviews, two important categories of plastic debris emerged when considering transport to the waterways: plastic debris greater than 5 mm and plastic debris smaller than 5 mm. Due to the regulatory mechanisms in the watershed

(Trash Total Maximum Daily Loads), a distinction has been made between plastic debris that can be caught by a catch basin insert with a 5 mm mesh (>5 mm) and plastic debris that cannot (<5 mm).

### GREATER THAN 5 MM PLASTIC DEBRIS

---

There are two main types of plastic debris greater than 5 mm that enter the Los Angeles and San Gabriel River Watersheds (LA and SG River Watersheds): trash that is improperly disposed indirectly (e.g., littering on streets and parks) and trash that is directly dumped into the river.

There is a significant difference between the LA River and SG River with respect to this larger debris – the LA River Watershed Trash TMDL has led to the installation of thousands of catch basin inserts that are capable of capturing nearly all greater than 5 mm plastic debris, while the SG River generally does

---

not have catch basin inserts and so plastic debris of all sizes can pass through the catch basin (as can be seen in the upper right of the conceptual model, Figure 5-2). The inserts in the LA River Watershed capture most, but not all, of the trash entering the catch basins. A City of Los Angeles study measured the

inserts capturing 98%-99% of trash over a year, while capturing 80%-90% of trash in storms with more than 0.25 inches of rain (City of LA, 2006). Since the SG River does not have catch basin inserts, it almost certainly receives significantly more street litter than the LA River does.

### SMALLER THAN 5 MM PLASTIC DEBRIS

There are three main types of plastic debris smaller than 5 mm that enter the river: plastic that is improperly disposed of that breaks down on land into smaller than 5 mm pieces, preproduction plastic (typically sized from 1 mm to 5 mm), and <1 mm microplastics such as microbeads and microfibers that are washed into the sewer system to WWTPs.

The plastic that breaks down into <5 mm pieces can be a larger piece of plastic that

goes through breakdown processes such as being run over by vehicles, or sun, wind, and rain exposure. Due to their composition, certain types of plastic, such as polystyrene, are more susceptible than others to such breakdown. Preproduction plastic are further discussed under the “Industry Plays a Role in the Plastic Debris Problem” Findings section. Microbeads and microfibers are discussed further in the “Microplastics are an Emerging Type of Plastic Debris” Findings section.

### CONCEPTUAL MODEL

Our understanding of the types, sources, methods, and transport of plastic debris in the LA and SG River Watersheds is best displayed with a conceptual model (Figure 5-2 on next page). Plastic debris is grouped into three categories based upon type: litter, preproduction plastic, and microplastics. These types are grouped in this manner because they have different sources and

distinct methods of transport. It is important to highlight these distinctions as it may better direct policies to reduce plastic debris. This model does not represent an exhaustive list of the types, sources, methods, and transport of plastic debris in the watersheds; however, it represents what we consider the most significant and impactful.

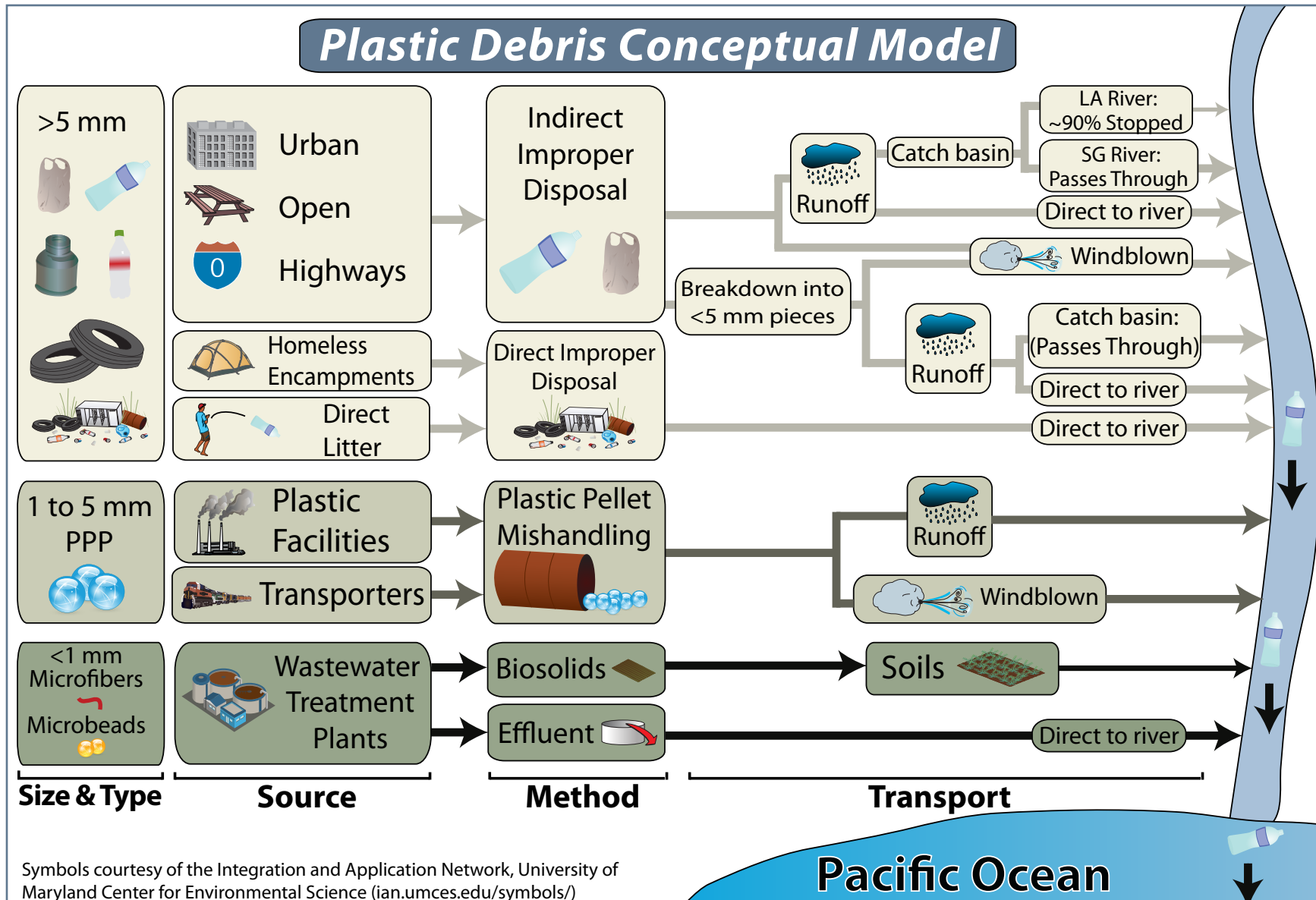

Figure 5-2 The impact, sources, method of litter, and transport of plastic debris in the Los Angeles and San Gabriel River Watersheds ("PPP" stands for preproduction plastic).



---

## 5.2.2 ZERO TRASH TMDLS ARE HIT OR MISS

---

California has historically been a leader in environmental policy and has implemented various regulations to reduce plastic debris entering the marine environment. In our study region, this effort has been led by the Los Angeles Regional Water Quality Control Board (LARWQCB) with Zero Trash Total Maximum Daily Loads (TMDLs) for the LA River Watershed and the East Fork and Legg Lake sections of the SG River Watershed. In this section, we discuss how the LA River Watershed Trash

TMDL has led to a large increase of structural BMPs that have likely reduced plastic debris (although not every affected city is yet in compliance). However, the language of the LA River Watershed Trash TMDL allows for some trash to be emitted (such as <5 mm pieces) despite the objective of zero trash. Additionally, the East Fork and Legg Lake Trash TMDLs may not be effective at reducing trash, due to lack of enforcement, as evidenced by high trash counts.

### TMDL BACKGROUND

---

The impetus for the Trash TMDLs was established when these sections of the watershed had their beneficial uses recognized as impaired from trash by the Los Angeles Regional Water Quality Control Board (LARWQCB). The beneficial uses most common in the two watersheds are municipal drinking water, groundwater recharge, water contact recreation, noncontact water recreation, warm freshwater habitat, and

wildlife habitat. When these beneficial uses are recognized as impaired by a pollutant such as trash, a TMDL is implemented to restrict discharge of the pollutant. For all Trash TMDLs in the LA and SG River Watersheds, zero trash is recognized as the maximum amount of trash that can be emitted to the waterways before beneficial uses are impaired (LARWQCB, 2011).

### LA RIVER WATERSHED: TRASH TMDL AND COMPLIANCE REPORTS

---

The LA River Watershed Trash TMDL went into effect in 2007 and requires cities in the LA River Watershed to discharge zero trash by 2016 (LARWQCB<sup>1</sup>, 2007). The LARWQCB monitors their compliance every year by requiring each city to meet a yearly reduction from their initial waste load allocation with the eventual target of zero trash. For example, in 2007 the City of Los Angeles was given a waste load allocation of 1,286 tons. By 2012, the City must have reduced its trash by 70% to 386 tons, and by 2016 they must be

discharging zero tons. Exceeding their waste load allocation will subject the permittees to enforcement actions (LARWQCB<sup>2</sup>, 2007).

The TMDL covers 43 parties: 41 cities, the County of Los Angeles and the areas they have jurisdiction over, and Caltrans. The TMDL waste load allocations have been implemented into the NPDES MS<sub>4</sub> permits for each party except for Long Beach and Caltrans. NPDES Municipal Separate Storm Sewer System (MS<sub>4</sub>) permits are

used to regulate stormwater discharges from municipalities (CVRWQCB, 2013). In Los Angeles County, there are two main MS<sub>4</sub> permits: one permit is for the unincorporated areas under jurisdiction of Los Angeles County and the 87 municipalities within the county (LARWQCB, 2012) and the other permit is for Long Beach (LARWQCB, n.d.). Additionally, Caltrans has a statewide MS<sub>4</sub> permit that covers many of the highways in the watershed (SWRCB, 2012).

Forty of the cities and the County of Los Angeles are covered under the same MS<sub>4</sub> permit (these 41 permittees will be referred to as “cities” hereafter). Through their MS<sub>4</sub> permit they must submit a yearly compliance

report to the LARWQCB in which they outline if they are meeting their trash target. Each city receives a template spreadsheet for filling out their compliance data. The separate MS<sub>4</sub> permits for Long Beach and Caltrans have not required them to submit Trash TMDL compliance reports. However, beginning in 2014, a new MS<sub>4</sub> permit for Long Beach went into effect and requires that the city submit a Trash TMDL compliance report (LARWQCB, 2013).

We obtained all 41 reports for 2012 from the LARWQCB for the cities that must submit compliance reports and our analysis found that 31 out of 41 permittees are in compliance with the 70% trash reduction required by 2012 (Figure 5-3).

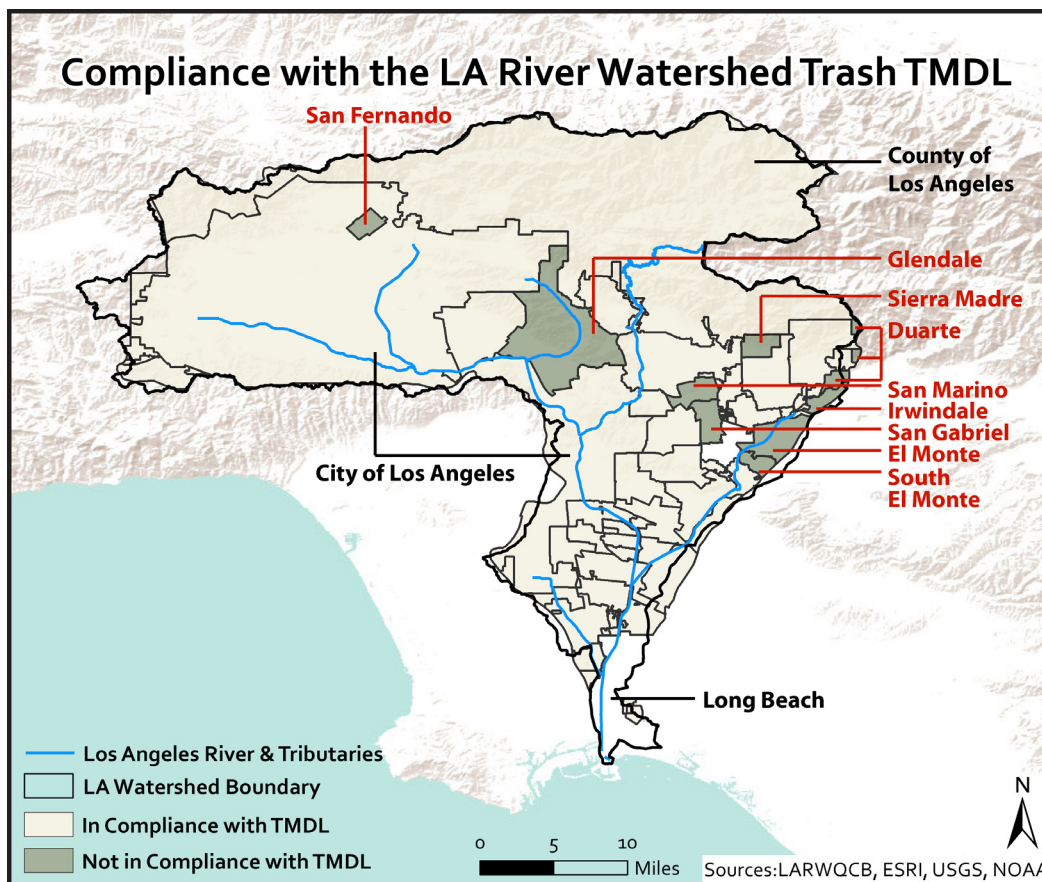

*Figure 5-3 Cities and compliance status under the LA River Watershed Trash TMDL as of 2012. All cities not in compliance all labeled in red; only the largest cities in compliance are labeled.*

Permittees can be in compliance by three different methods: having a higher percentage of full capture systems in their catch basins (by land area or total number of catch basins) than their trash reduction target, monitoring for trash to determine if there is less trash than their waste load allocation, or by stating their case to the LARWQCB that they are in compliance by other means.

A full capture system is a device that is capable of capturing trash that is greater than 5 mm – these are most commonly catch basin inserts. With 51% of cities complying by installing full capture systems, it is the most common method of being in compliance (Table 5-1). This method is the most popular because once a full capture system is installed, the city is assumed to be discharging zero trash from that catch basin and no monitoring is required. However, it is likely that trash is still being discharged for reasons expanded upon in the next section.

*Table 5-1 Cities in compliance with the LA River TMDL by installing a higher percentage of full capture systems than the 70% trash reduction required by 2012. Cities within one percent of the 70% mark were included.*

City	Percent of Catch Basins with Full Capture Systems
Arcadia	100%
Bell	92%
Bell Gardens	93%
Burbank	100%
Calabasas	72%
Carson	100%
Commerce	84%
Compton	100%
Cudahy	88%
Downey	70%
Huntington Park	86%



City	Percent of Catch Basins with Full Capture Systems
La Canada Flintridge	69%
Los Angeles County	69%
Lynwood	100%
Maywood	85%
Montebello	84%
Paramount	92%
Pico Rivera	84%
Signal Hill	79%
South Gate	86%
Vernon	91%

SOURCE: LARWQCB (2012)

Eight of the permittees (20%) were in compliance by demonstrating that their measured amount of trash was below their waste load allocation (Table 5-2). Storm drain monitoring was conducted twice during July or August in five different land use categories.

This data was then extrapolated based on total land area, street sweeping frequencies, and amount of rainfall days greater than 0.25" and reported in each permittee's annual compliance report.

*Table 5-2 Cities in compliance with the LA River TMDL by having their monitored level of trash lower than their waste load allocation.*

City	Total Trash Discharged	Waste Load Allocation (70% reduction from 2007 baseline)	Unit
Alhambra	20,623	20,628	lbs
Bradbury	651	3,649	lbs
Hidden Hills	43	3,246	lbs
Los Angeles	116,725	412,454	gals
Monrovia	1,359	30,296	lbs
Monterey Park	26,215	27,504	lbs
South Pasadena	987	8,507	lbs
Temple City	1,501	9,546	lbs

*SOURCE: LARWQCB (2012)*

If a city is not in compliance by monitoring their trash or by installing full capture systems, it is possible for the LARWQCB to consider them in compliance if they judge that other BMPs are satisfying the requirements. We were unable to examine the LARWQCB’s judgments on the 2012 reports

because they were not available. We were able to review the compliance reports for the 12 cities not in compliance with full capture systems or monitoring and found that two of the cities have likely met LARWQCB standards, but ten of the cities are probably not meeting the standards (Table 5-3).

**Table 5-3 City Compliance with the LA River Watershed Trash TMDL**

City	Compliance (Yes/No)	Reasons
Duarte	No	Have not complied due to issues with applicability of extent of TMDL and unknown status of County's responsibility of its catch basins
El Monte	No	Have not complied due to issues with applicability of extent of TMDL and unknown status of County's responsibility of its catch basins
Glendale	No	Have less than 50% full capture systems; no monitoring
Irwindale	No	Have 28% full capture systems; no monitoring
Lakewood	No	Have 66% full capture systems; no monitoring
Pasadena	Yes	Have installed 74% full capture systems in high trash areas; 29% in low trash areas; suite of BMPs including increased trash control measures during major events, citywide plastic bag ban, educational campaigns, and increased trash receptacles.
San Fernando	No	Have 24% full capture systems; no monitoring
San Gabriel	No	Have not complied due to issues with applicability of extent of TMDL and unknown status of County's responsibility of its catch basins
San Marino	No	Have 12% full capture systems; no monitoring; claim to be in compliance with BMPs such as increased street sweeping, but this is a fairly common BMP and would likely not ensure compliance
Santa Clarita	Yes	Very small area of land within the watershed that contains no catch basins; only road in that area is swept
Sierra Madre	No	Have 1% full capture systems; lack of funds to install more full capture systems and unable to monitor due to dry weather
South El Monte	No	Did not fill out form correctly; unknown if they are in compliance

SOURCE: LARWQCB (2012)



---

Generally, most cities that are not in compliance have installed some full capture systems but are short of the 70% reduction target for 2012. None of the cities in noncompliance monitored for trash to see if they were in compliance. It is possible that many of these cities would be in compliance with the simple monitoring plan called for in the LA River Watershed Trash TMDL. Three of the cities on the eastern edge of the watershed, Duarte, El Monte, and San Gabriel, have not complied due to disputes over jurisdiction of trash-impaired stretches of the watershed, as their cities border the SG River Watershed. It was unknown at the time of this report if enforcement actions have been brought (or will be brought) against the cities that are not in compliance as prescribed

in the LA River Watershed Trash TMDL Document, as pending enforcement actions are considered confidential by the LARWQCB (J. Newman, Personal Communication, February 11, 2014).

Given that the Trash TMDL has led to the installation of thousands of catch basin inserts and increased use of non-structural BMPs, we believe that it has reduced a large amount of plastic debris in the watershed. It is difficult to quantify this reduction; however, as the compliance reports are either based off of the number of full capture systems installations, or a couple of monitoring events extrapolated over an entire year. However, it is believed that the overall effect of the LA River Watershed TMDL is almost certainly positive.

### *Discharging Trash While Complying with Trash TMDLs*

Even if a city is in full compliance with the LA River Watershed Trash TMDL, it is likely that some trash is still being discharged due to the mesh size of full capture systems, wind transport, and direct disposal.

A full capture system is defined as a device (or series of devices) that traps all trash that is greater than 5 mm, usually with a 5 mm mesh screen (LARWQCB, 2007<sup>2</sup>). The most common full capture system installed in the LA River Watershed is a catch basin insert (Figure 5-4). Therefore, trash that is smaller than 5 mm has the ability to pass through the mesh and enter the LA River and its tributaries. It is common for certain types of plastic, such as polystyrene (e.g., Styrofoam™) and polyethylene (e.g., plastic bags), to break down after being littered and

these small pieces would be common items to pass through the 5 mm mesh.

This standard of a 5 mm mesh was adopted because a smaller mesh size would lead to flooding problems as debris becomes trapped and blocks water from passing through (J. Guerrero, personal communication, May 21, 2013). This mesh size may have also been decided upon as the diameter of a cigarette, which is one of the common litter items, is slightly larger than 5 mm (Shimoda Group, LLC., 2010). Cities have typically avoided true full capture systems capable of capturing nearly all sizes of trash, such as Continuous Deflection Separator units, because they are more expensive than catch basin inserts.



*Figure 5-4 A Catch Basin Insert. The 5 mm mesh and inlet at the top allows some trash particles to flow through to avoid flooding problems. Photograph courtesy of StormTek*

Windblown plastic can bypass full capture systems by being carried over catch basins directly into the river (LARWQCB, 2007<sup>1</sup>). Plastic bags and films have a shape (parachute like) and low weight that allow them to be easily mobilized by wind. Given the emphasis of the Trash TMDL on structural BMPs in catch basins, windblown trash is not fully accounted for.

Another source of trash that is not taken into account by full capture systems is direct, improperly disposed trash from riverside homeless encampments, or from people that dump their trash into the river. Therefore, even if a city is in full compliance with full capture systems, a significant amount of trash still has the potential to enter waterways through these avenues.

## SAN GABRIEL RIVER WATERSHED: TWO SMALL TRASH TMDLS, BUT NO COMPREHENSIVE ONE

Trash TMDLs have also been implemented on the East Fork San Gabriel River (East Fork Trash TMDL) and Legg Lake (Legg Lake Trash TMDL), two small recreational areas of the SG River Watershed, due to impairment of their beneficial uses. No comprehensive Trash TMDL, similar to the LA River Watershed Trash TMDL, exists in the SG River Watershed.

The East Fork Trash TMDL was adopted in 2001 in response to the high amounts of trash left behind by recreational users of the area (LARWQCB, 2000). This region falls under the jurisdiction of the U.S. Forest Service. The U.S. Forest Service estimated that over two hundred 32-gallon bags worth of trash were littered every weekend due to recreational uses, such as picnicking and barbecuing (Jao, 2013; Sahugun, 2012). Similar to the

LA River Watershed Trash TMDL, a zero trash goal was set to restore the beneficial uses of the East Fork. BMPs such as additional trash receptacles, more frequent cleanups, and anti-littering signs were planned to be implemented to meet the TMDL (LARWQCB, 2000).

The implementation plan for this Trash TMDL was created, but no annual reports or other means of compliance were mandated. The lack of required monitoring may be due to the nonpoint source nature of the trash from this region and because the responsible party, the U.S. Forest Service, may not be as familiar with TMDL compliance regimes (J. Newman, Personal Communication, November 27, 2013).

Our analyses of a series of studies, called the Bight '13 trash collection, found that despite Trash TMDL implementation over a decade ago, the East Fork of the SG River area has some of the highest plastic debris counts out of all of the areas surveyed in both the LA and SG River Watersheds (Figure 5-5). Recent news stories on the

East Fork SG River have noted that the U.S. Forest Service is not equipped to regulate recreational areas and has no resources to put towards managing the TMDL (Jao, 2013; Sahugun, 2012). Therefore, we suspect that the East Fork SG River Trash TMDL has been unsuccessful at restoring the beneficial uses of the watershed that are impaired by trash.

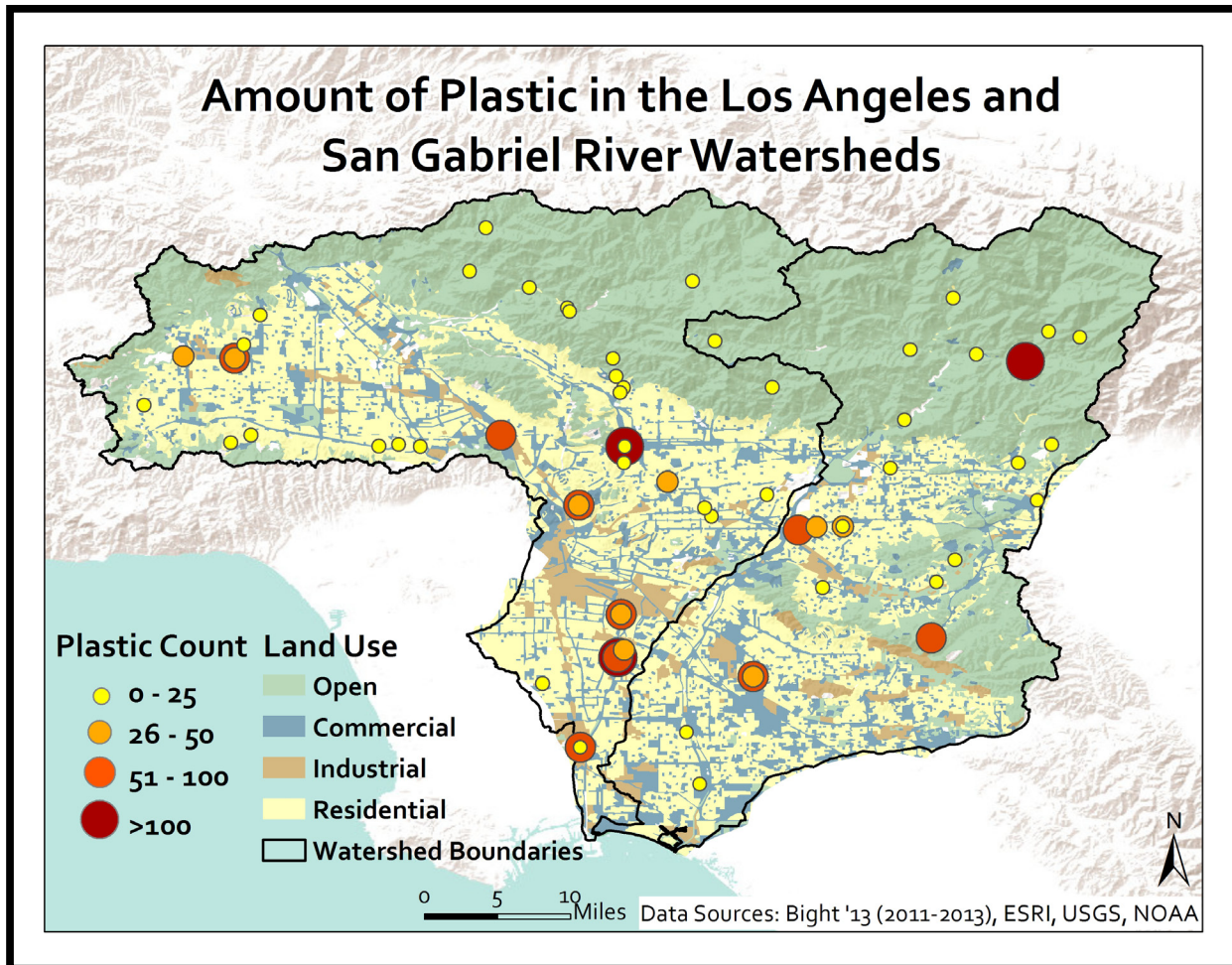

*Figure 5-5 Trash debris in the LA and SG River Watersheds. The highest debris count was found in the northeast part of the map in the East Fork San Gabriel River.*

The Legg Lake Trash TMDL was created in 2008 to address trash being littered by recreational users and entering storm drains (LLTTJG, 2008). Legg Lake is on the SG River in the South El Monte region. Jurisdictions with nonpoint sources were required

to comply with BMPs and monitoring (LARWQCB<sup>2</sup>, 2007). The typical trash in this area was cited as polystyrene cups and cans (LARWQCB<sup>2</sup>, 2007). For those jurisdictions with storm drains around the lake, full capture could be achieved with a full capture system

---

with a 5 mm mesh, similar to the LA River Watershed Trash TMDL. These types of full capture systems, however, would face the same issues as in the LA River Watershed Trash TMDL by allowing smaller than 5 mm pieces of plastic debris to flow through.

As a follow-up to the LARWQCB's Legg Lake Trash TMDL document, a Trash Monitoring and Reporting Plan for the Legg Lake Trash TMDL was created to outline the specifics of the implementation strategy (LLTTJG, 2008). An annual report was mandated that would establish a trash baseline in the first two years of the Trash TMDL, with a 20% reduction from the baseline each year thereafter. The baseline was scheduled to be established from 2009 to 2011, with the first 20% reduction beginning in 2012. This report would include the previous year's collected trash (from a weekly monitoring plan), photographic evidence from each weekly survey, future scheduling of TMDL compliance, and other means of determining compliance. Attempts to obtain these reports from the LARWQCB were unsuccessful. We assume this is because they have never been submitted. Without these monitoring reports, we were unable to ascertain whether the Legg Lake Trash TMDL is working.

The rest of the SG River Watershed has not had its beneficial uses declared impaired by trash by the LARWQCB and as such it does not currently qualify for a Trash TMDL. Much like the LA River Watershed, the beneficial uses most common in the SG River Watershed are municipal drinking water, groundwater recharge, water contact recreation, noncontact water recreation, warm freshwater habitat, and wildlife habitat.

In the SG River Watershed, municipal drinking water is considered either an existing or potential beneficial use for every reach in the watershed. Similarly, every reach is an existing or potential beneficial reach for wildlife habitat. Groundwater injection is an existing or intermittent beneficial use for nearly all of the watershed's waterways much like noncontact water recreation is. Water contact recreation and warm freshwater habitat are also beneficial uses for nearly all of the reaches and are a mixture of potential, existing, or intermittent uses.

Site visits to the SG River Watershed revealed dozens of pieces of plastic debris in the SG River and one of its major tributaries, Coyote Creek. Bight '13 trash surveys in the SG River Watershed have collected 23 pieces of plastic debris on average per site visit in areas not covered by a Trash TMDL. Another study, by Algalita Marine Research Institute, sampled both the LA and SG Rivers for plastic debris. The results of the study found that over three separate days of sampling, tributaries of the SG River Watershed yielded over 275,000 pieces of plastic debris, while tributaries from Los Angeles had 2,300,000 pieces. This equated to nearly 28 tons of debris in the SG River Watershed and 33 tons of debris in the LA River. The greater difference in count compared to weight can be explained by the higher amount of "whole items" of trash found in the SG River, which weigh more than the foam pieces that made up the majority of the LA River count.

Given that the Zero Trash TMDLs have recognized that any amount of trash impairs



---

the beneficial uses of a watershed, that trash has been frequently collected and observed within the SG River Watershed, and that the SG River shares the same beneficial uses as the other areas under these Trash

TMDLs, it would appear that the area should come under the regulation of a similar Trash TMDL. This is further discussed under the “Implement a Comprehensive San Gabriel River Watershed Trash TMDL” Action Item.

### OTHER TRASH TMDLS

---

The Santa Monica Bay Nearshore Debris TMDL, enacted on March 28, 2012 by the LARWQCB, is a Zero Trash TMDL based on the LA River Watershed Trash TMDL. The area that empties into the Santa Monica Bay and the LA River Watershed are similar urban environments. In addition to what is covered in the LA River Watershed Trash TMDL, the Santa Monica Bay Nearshore Debris TMDL requires a plastic pellet monitoring and reporting plan for each municipality covered under the TMDL, except those that have no industrial facilities under their jurisdictions (LARWQCB, 2013).

The plastic pellet monitoring and reporting plan requires two monitoring events per year at each storm drain outfall in the TMDL boundaries. The TMDL encourages

municipalities to conduct more inspections of industries that handle plastic pellets in their region if they find a violation of the zero plastic pellet waste load allocation through their monitoring.

The Santa Monica Bay Nearshore Debris TMDL also addresses nonpoint sources, which the LA River Watershed Trash TMDL does not. The nonpoint sources considered are beaches, parks, parking lots, and hiking areas. The goal for the nonpoint sources covered in the TMDL is zero trash. The municipalities with jurisdiction over these nonpoint source areas will be in compliance with the TMDL by creating and implementing a BMP and Minimum Frequency of Assessment and Collection Program.

## 5.2.3 ASSESSING THE QUANTITY AND CHARACTERIZATION OF PLASTIC DEBRIS IN THE WATERSHEDS

In order to better understand plastic debris within the LA and SG River Watersheds, we obtained data collected within and around the watersheds to assess plastic debris quantity and characterization. The following sections describe analyses performed on

the various data we obtained. The studies discussed vary temporally and spatially and were conducted by multiple parties (Table 5-4). Full descriptions of these datasets can be found in Appendix H – Data Index.

*Table 5-4 Summary of Datasets*

Study	Group	Year(s)	Location
Bight '13	Southern California Stormwater Monitoring Coalition (SMC)	2011-2013	Los Angeles and San Gabriel River Watersheds
TMDL Monitoring	City of Los Angeles Bureau of Sanitation	2012	City of Los Angeles
Trash Boom	Los Angeles County	2000-2012	Long Beach
Beach Cleanup	National Oceanic and Atmospheric Administration (Heal the Bay study)	2012-2013	Los Angeles Beaches
Furman	Adam Furman	2012	Fullerton Creek
Herondo Drain Teach and Test Program	Surfrider Foundation	2009-2012	Hermosa Beach

### PLASTIC DEBRIS QUANTITY

Our primary quantitative objective was to determine the total amount of plastic found in the LA and SG River Watersheds. To quantify this, we calculated plastic debris as a percentage of total trash among the different land use types. Quantification was difficult; however, due to the different methodologies

used in many of the trash collection studies, including different metrics for measuring plastics (volume, weight, or count), different land use categories, and non-standardized methods for plastic categorization. In order to gain a better understanding of the quantity of trash in the watersheds compared to each

---

other and compared to surrounding land uses we performed two statistical analyses. These analyses aimed to determine if differences in

total quantity of trash and/or in quantity of certain types of trash existed.

### *Plastic Debris Quantity in the Los Angeles and San Gabriel River Watersheds*

To determine trash quantity we found three datasets that were collected within our study region and used collection methodologies that were well suited for analyses. This included data collected within the LA and SG River Watersheds, Fullerton River, and storm drains in the City of Los Angeles. To determine the portion of trash that was plastic, we aggregated land use data from all three studies, and compared plastic quantities.

The first study, Bight '13, included a large dataset of samples collected from 121 sites along the LA and SG River Watersheds over the course of a three-year period (2011-2013) (Figure 5-6). To calculate the total amount of plastic observed in each location type (urban and open), the sum of the plastics recorded in each region was divided by the total number of that location type. Our analyses showed that plastics were a more common type of trash in urban locations. In the 56 open-space locations, a total of 840 pieces of plastic were recorded, averaging 15 pieces of plastic per site. In the 60 urban site locations, 1,615 plastic pieces were recorded, averaging just less than 27 plastic pieces per site.

Data from a trash accumulation study in Fullerton Creek were collected under the same categories as the study listed above and were therefore easy to combine. These data were collected over a one-year period at four locations with periodic repeated monitoring. In order to analyze if the same

pattern of trash was observed in this study, we broke the sites into open (one of the sites) and urban (the remaining three sites) land-use categories and performed the same sum analysis described above (Figure 5-6).

The third study measured trash in storm drains within the City of Los Angeles. These data included information on 239 sites and included more descriptive land-use categories, which we sorted into the broader categories of open and urban to align with our other datasets. The categorization of plastics in this study differed from the categorization used in the other two studies, and therefore minor categorical discrepancies may exist (category breakdown is reflected in Figure 5-6).

The three studies found different amounts of plastic trash in each land use type, but they all remained within 20% of the average of 50% plastic debris (Figure 5-6). Overall, in the LA and SG River Watersheds region, 43%-70% of trash was plastic. While the amount of plastic in the studies was around 50%, when broken down by land use, one of the studies found plastic to be a higher percent of total trash in urban land, while the other two studies found the opposite trend – a larger percentage of trash was associated with open land uses (Figure 5-6).

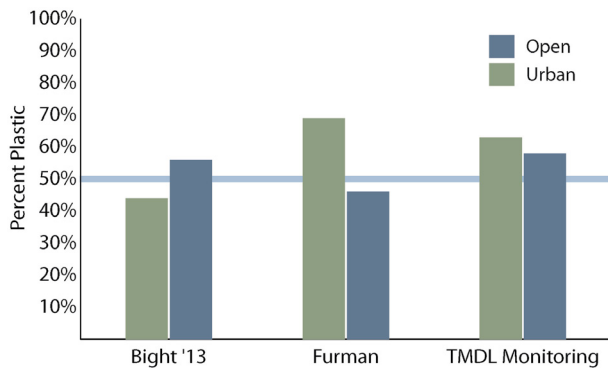

**Figure 5-6** Data from three separate studies, summed by land use and plastic as percent of total trash. Plastic data represented by total count. Sources: Bight '13 (2011-2013), Fullerton Creek study (2013), TMDL Monitoring (2012).

Data from the three datasets showing plastic count as a percent of total trash reveals slightly different trends between land uses. Analyzing plastic as a percent of the total can be misleading because it does not include information on the absolute number of plastic pieces. For instance, while the Fullerton Creek study showed plastic as a large percent of total trash in the open land use, the total count of plastic was lower in open versus urban land use (Figure 5-6), even though the same transect length for the monitoring site was used (e.g., in one of the urban land uses (Urban 1), 638 plastic pieces represented 48% of the trash, while in the open land use (Open 1), 469 plastic pieces represented 69% of the total trash).

**Table 5-5** Plastic observed along four 200-foot transects with different land uses in Fullerton Creek. Derived from Furman, 2013

	Urban 1	Urban 2	Urban 3	Open 1
Plastic Count	638	865	627	469
Total Trash Count	1,329	2,063	1,344	676
Plastic as Percent of Total	48%	42%	47%	69%

Examination of the percent of plastic trash may lead us to believe that open space is more likely to accumulate plastic debris, but examination by the total count of plastic reveals higher accumulation in urban regions. In terms of developing management plans, only looking at the percent of plastic may lead to more waste reduction measures in open regions, but when total count is examined we can see that urban regions contribute a greater amount of plastic debris. Depending on the metric used different conclusions can

be made. The same challenge was faced when we analyzed the storm drain data collected in the City of LA.

**Plastic breaks down into small lightweight pieces – when measured by count, plastics comprise up to 67% of the storm drain debris in Los Angeles.**

These data included information on the volume, weight, and quantity of collected



trash. Classification of trash items were put into 12 categories: food service (clamshells, cups, etc.), snack and candy packaging, bottles and cans, non-CRV containers, molded plastics, metals, glass, cigarette butts, polystyrene, paper, plastic film, and clothes and fabric. Depending on the metric (volume, weight, count) used, different plastic totals were generated. For instance, using the same data, measurements by volume revealed that plastic made up 52% of total trash, while weight revealed 41%, and count 67%. Measuring plastics by count, compared to weight and volume, generates results that show the largest percentage of plastics. These results are consistent with the fact that plastics are often lightweight but can be

easily fragmented and broken down into small pieces.

In conclusion, analyzing the data in terms of the most commonly observed trash item revealed different trends (Figure 5-7). By graphing the top six most common types of litter in each of the three metrics (volume, count, and weight) different plastics appear to be the most common litter items. Depending on the metric used, polystyrene, cigarette butts, plastic tarps, candy wrappers, and plastic films are the most commonly found plastic littered items. The top four categories of plastic items under multiple measurement metrics are plastic film and bags, snack and candy packaging, polystyrene, and heavy plastic film and tarps.

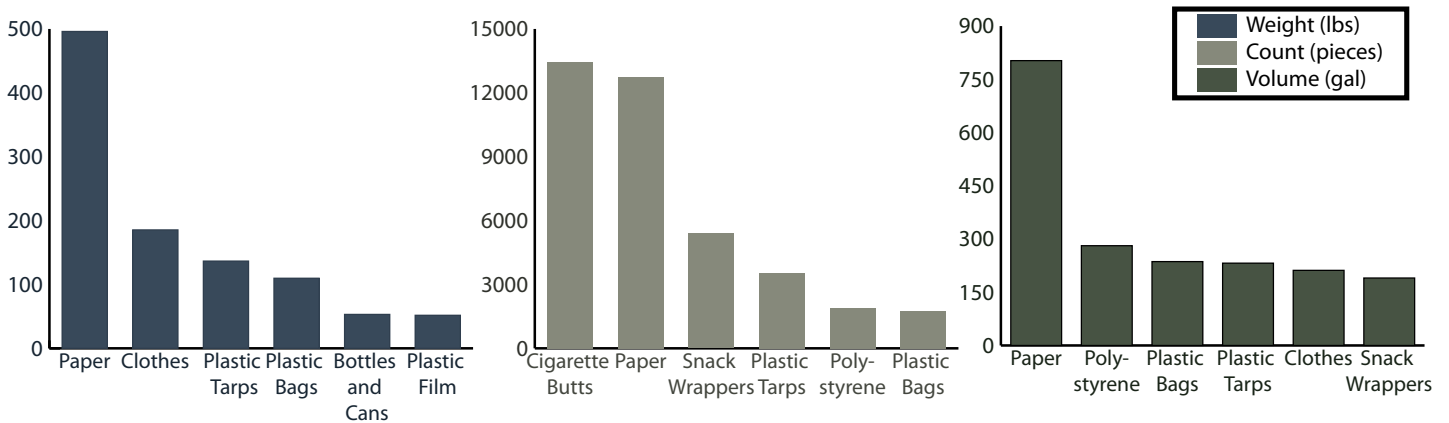

Figure 5-7 Top 6 categories of trash by count, weight, and volume in the City of Los Angeles from July to August. Source: TMDL Monitoring (2012).

### Land Use Statistical Analysis

We also analyzed whether the LA River Watershed contained different quantities of plastic compared to the areas surrounding it. We had data for both urban and open land uses, but a variety of factors made open land less variable and therefore more suitable for statistical analyses. First, population varies more in urban regions, especially when

comparing urban regions in the City of Los Angeles to suburban ones. In contrast, open land (most often parks and natural habitat) was assumed to be associated with lower density populations, and thus subject to less population variability. Second, in the LA River Watershed, open land was mostly in the northern mountainous headwater

regions where samples collected are more likely to represent true trash patterns. Farther downstream, samples may less accurately represent local trash quantities because the trash may have originated upstream.

As mentioned above, to examine the quantity of plastics in open areas of the LA and SG River Watersheds, we compared open regions in the watersheds to reference regions around it. Data surveyed to the northwest of the LA River Watershed was used as a set of reference points, identified in our graphics as “Western Reference.” Data from the SG River Watershed were used as reference points for

the eastern side of the LA River Watershed and are identified as “Eastern Reference” (Figure 5-8). In order to most accurately compare regions within the LA River Watershed Trash TMDL to regions without a TMDL, data points without a latitude/longitude were omitted from the analyses (along with points covered under the East Fork Trash TMDL of the SG River Watershed). This selection of data ensured that regions with Trash TMDL coverage in the upper LA River Watershed were being compared to regions without Trash TMDL coverage to the west and east.

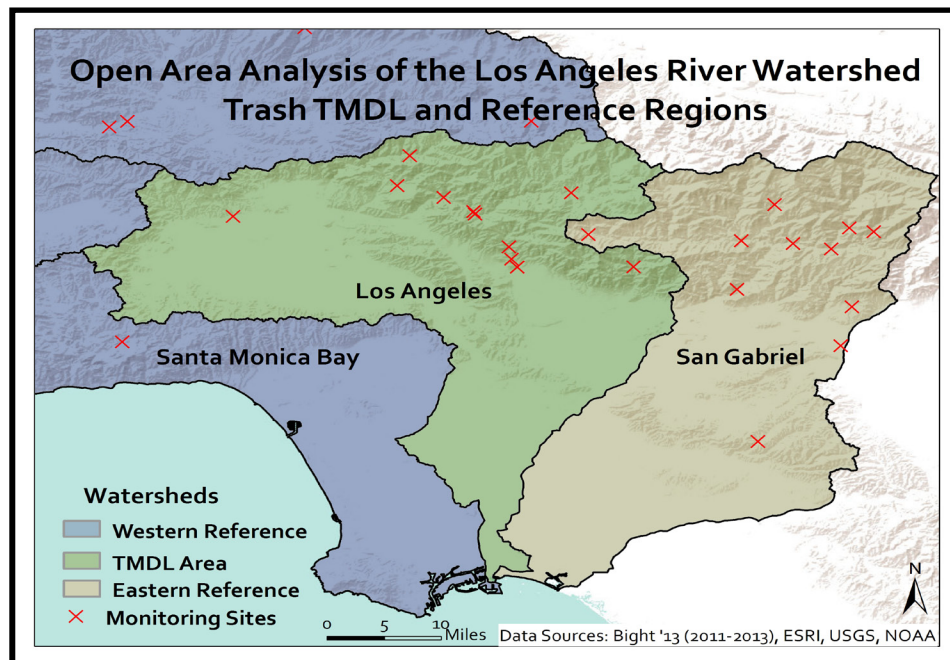

Figure 5-8 Map of data points in the TMDL zone, and reference zones.

For the compositional analysis, we used the Primer statistical package to perform PERMANOVA (Permutational Analysis of Variance) to determine if differences in mixture, abundance, or frequency of plastic existed. We are 95% confident that there is no statistical difference between the composition of trash in the Trash TMDL region and the reference regions. While not definitive due to the small sample size, this

data does not support that the LA River Watershed Trash TMDL adequately addresses plastic debris in open areas.

After finding no statistical difference in the composition of plastic between regions, we tested for differences in the abundance of plastics. For this analysis, single ANOVA tests were performed to determine if differences in abundance existed between the LA River Watershed Trash TMDL regions and the

reference regions (Eastern and Western Reference regions.) To perform the analysis, we used an equal number of data points from the LA River Watershed and the Eastern and Western references.

Our ANOVA results did not reveal a statistically significant difference ( $p=0.7$ ) in abundance for any given type of plastic debris among the three watershed categories (Figure 5-9). This analysis does show some trends in the abundance of certain plastic types in the open land for different watersheds, but they were not statistically significant. For example, our results show that the LA River Watershed data contain greater quantities of bags, pieces, and lids than the Western and Eastern reference points. The large error bars associated with these findings, however, indicate this difference is not statistically supported. Given that a Trash TMDL exists in the LA River Watershed and none exist for the

sections we examined in the Eastern and Western references, the fact that there was no statistically significant difference in count of plastic debris may indicate that more effective Trash TMDL measures need to be put into place. It is also possible that the lack of significance generated from our analyses has limited accuracy due to the small sample size available for analyses.

In summary, performing PERMANOVA and ANOVA analyses on the total amount of plastic and by the total amount of plastic by category in the LA River Watershed did not reveal statistically significant differences in distribution. Based on these results, there is no statistical evidence to support that the amount of plastic in the LA River Watershed is less than that in adjacent open space regions without Trash TMDLs. Our results suggest that more measures should be taken to address plastic debris in open areas within the LA River Watershed.

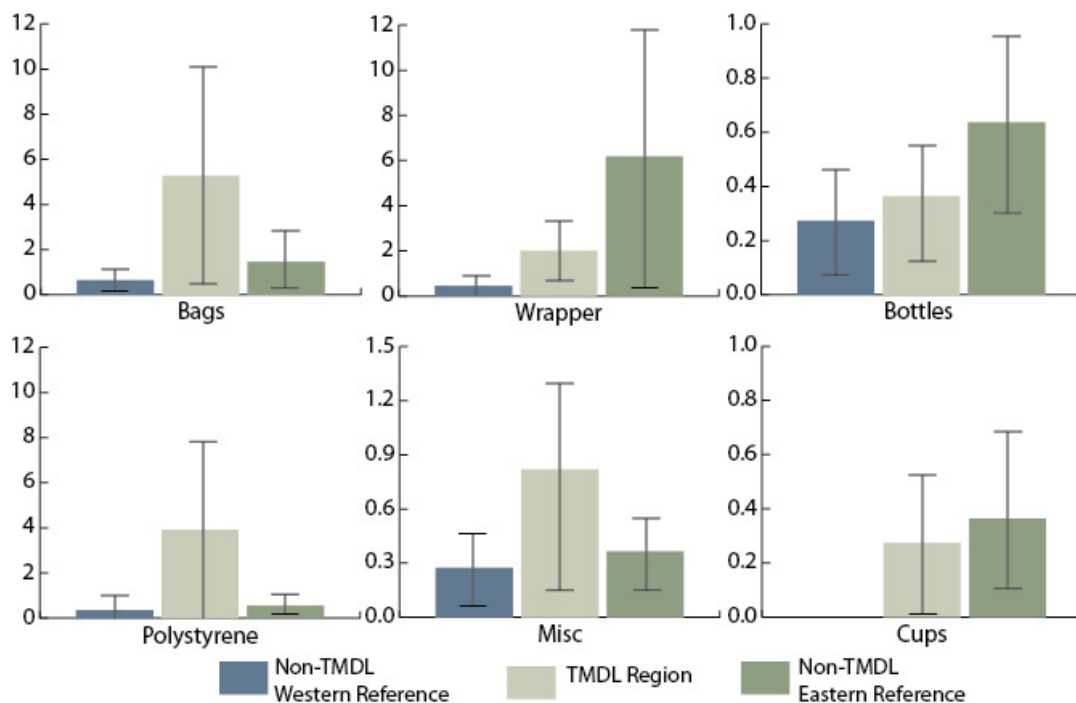

**Figure 5-9 Average abundance per sample site results of ANOVA of plastic types among the watersheds. LA is the Los Angeles River Watershed, WR is the Western Reference areas, and ER is the Eastern Reference (Non-TMDL regions of the San Gabriel River Watershed) area. Average abundance refers to the average number of times that category of plastic was counted in each study region.**

Sources: Bight '13 (2011-2013), TMDL Monitoring (2012).

---

### *Plastic Debris Baseline*

The Zero Trash TMDL for the LA River Watershed went into effect in 2007, with a goal of zero trash by 2016. The 2007 baseline waste load allocation for the 43 permittees of the TMDL (41 cities, the County of Los Angeles, and Caltrans) was 2,826 tons of trash being discharged into the LA River (LARWQCB, 2007). This figure was assumed to be the amount of trash being discharged into the LA River Watershed. If we assume plastic debris to be about 50% of trash as shown by our previous analyses, the LARWQCB estimated that about 1,413 tons of plastic debris reached the waterways of the LA River Watershed in 2007.

According to the Trash TMDL, by 2012 the total waste load allocations were supposed to be reduced by 70%, meaning that only 424 tons of plastic debris should be reaching the waterway. We were unable to determine whether this figure is accurate because none of the datasets we had allowed for comprehensive quantification of plastic debris in the area. However, our analyses of the 2012 compliance reports from the LARWQCB revealed that not all of the permittees were in compliance with their 2012 waste load allocations. This is further discussed in the “Zero Trash TMDLs are Hit or Miss” Findings section.

### *Long Beach Trash Boom and Beach*

The City of Long Beach sits at the receiving end of all the trash that makes it downstream in the LA River Watershed. Long Beach has installed a trash boom near the mouth of the LA River to capture trash before it reaches the ocean. Due to the nature of the boom, vegetation and soil are also captured. The collected trash is periodically removed and weighed, along with the vegetation and soil, by a contractor (Figure 5-10). Due to

low accumulation rates in the dry season, the boom may not be cleaned for months. In contrast, during the wet season, multiple collections per month may occur. Based on a Los Angeles County study that analyzed the breakdown of trash in LA River Watershed catch basins, we used their assumption that only 5% of the amount weighed was human-generated trash (Noyes et al., 2004).



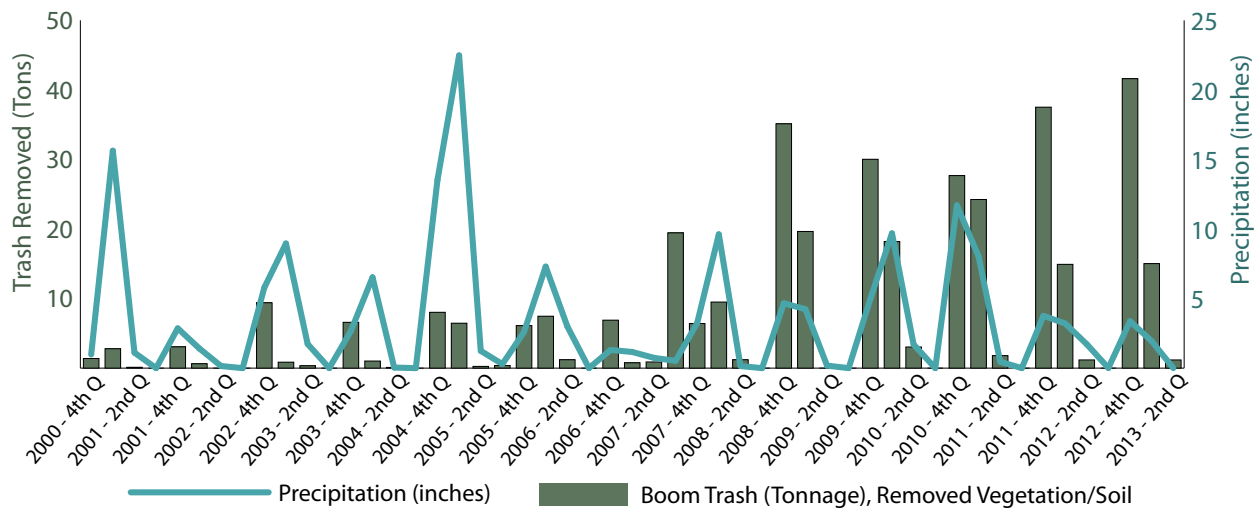
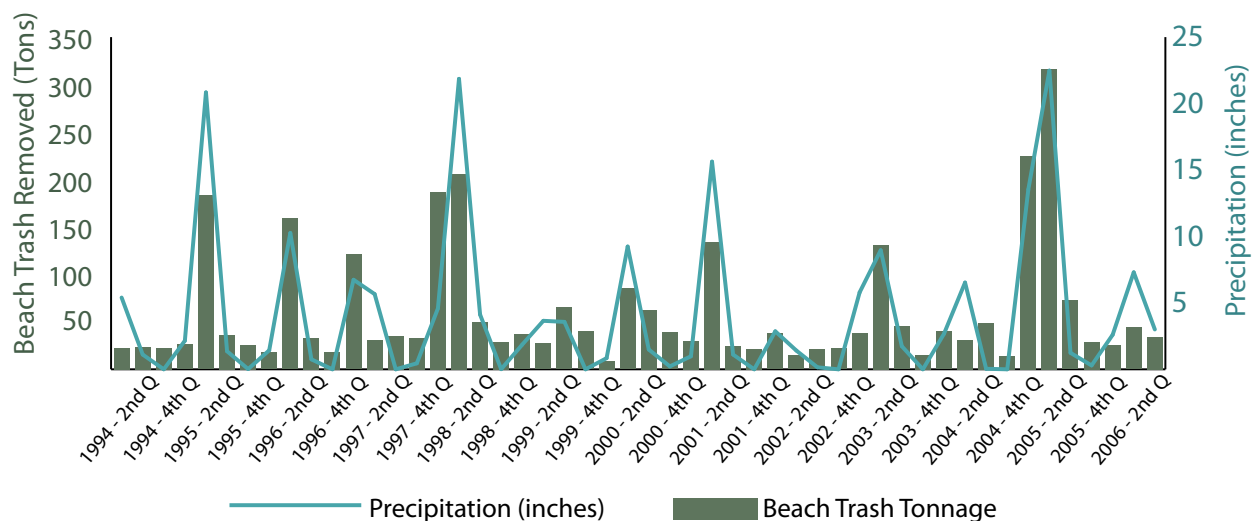

**Figure 5-10 Long Beach trash boom collection data compared to precipitation. (Based off data from the consulting agency in charge of collecting and weighing what the trash boom stops. Both precipitation and total trash collected are quarterly data. Precipitation source: Western Regional Climate Center, Los Angeles Civic Center, 2013.)**

The correlation between precipitation and trash collected by the boom is weak from 2000 to 2006. The El Niño year of 2004-2005 brought large amounts of precipitation, while the trash boom collected very little trash relative to the most recent years. According to the consulting firm that provided the data, the previous consulting agency that worked on the boom at the beginning of the data collection period (2000-2007) encountered problems with the boom breaking after large storms, leaving it unrepaired for months at a time (D. Sharp, Personal Communication, December 2, 2013). The correlation between precipitation and trash collected is stronger from 2007 to 2013 due to improved boom management, and is likely a better indicator of trash boom collection rates. The boom is now collecting a very small amount of the trash that is probably moving downstream with an annual range of 15-64 tons, given

that the LA River Watershed Trash TMDL estimated the total waste load of trash from the watershed at 2,826 tons in 2007.

Data from Long Beach cleanups of the beach near the mouth of the LA River illustrate the amount of trash that the boom is not collecting (Figure 5-11). For the Long Beach trash cleanups, trash was collected just south of the LA River on the beach in the City of Long Beach, and weighed at a nearby landfill. There is a strong correlation between precipitation and the amount of trash collected. Although the period covered by these data is before the reliable trash boom data, it appears that a significantly higher amount of trash is collected off the beach than from the trash boom, with an annual range of 96-331 tons for the beach cleanup compared to 15-64 tons for the boom collection.



**Figure 5-11 Beach cleanup collection data below Long Beach trash boom compared to precipitation.** (Based off data presented in the LARWQCB’s Los Angeles River Trash TMDL document. Both data series are presented quarterly, and the trash was collected and then weighed at a landfill. Precipitation source: Western Regional Climate Center, Los Angeles Civic Center, 2013.)

We conclude that only a small amount of the trash that travels to the mouth of the LA River is stopped by the trash boom. There is a large spread between the trash collection numbers

from the boom and beach data and the LARWQCB’s 2007 estimate of 2,826 tons for the watershed, and the majority of this trash is likely being transported to the ocean.

### Herondo Drain – Beach Data Analysis

As part of the Herondo Drain Teach and Test Program, Surfrider Foundation recorded both the weight and count of trash items from the Herondo Drain over a five-year period (2009-2013). While not in the LA or SG River Watersheds, Herondo Drain is located in the southern end of the Santa Monica Bay Watershed, which is to the west of the LA River Watershed. The area that drains to the Herondo Drain is a similar urban environment to that found in the LA and SG River Watersheds. Due to the similarities in location and land use we deemed these data to be useful for analyses.

This study concluded that plastic composed 89% of the total trash by weight and 96% of the total trash by count (Figure 5-12). The percentage of plastic trash by weight increased from 60% in 2009-2010 to 100% in 2012-2013 (Figure 5-12). These results are higher than was observed in the river and storm drain based studies discussed above. This difference may be because the drain is located near a beach, which allows for the possibility that a portion of the trash observed may be deposited from trash left by beachgoers or from trash deposited from the ocean.

*Table 5-6 Sum of trash collected at Herondo Drain.*

	Weight (Tons)	Number of Pieces
Total Trash	34.4	16,819
Plastic	30.6	16,212
Percent Plastic	89%	96%

SOURCE: HERONDO DRAIN (2009-2013)

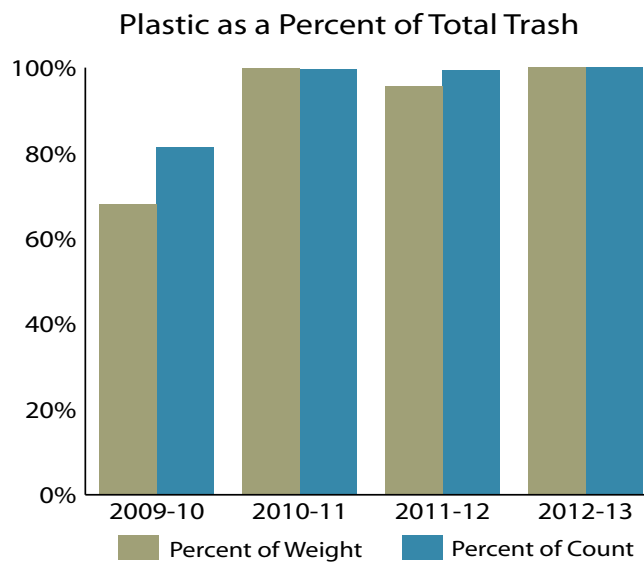

*Figure 5-12 Plastic as a percent of total trash at Herondo Drain. Source: Herondo Drain data (2009-2013)*

## PLASTIC DEBRIS CHARACTERIZATION

In addition to the relative quantities of plastic debris in the LA and SG River Watersheds and their respective land use sources, a characterization of the types of plastic was thought to be useful in addressing plastic pollution through policy. We began by analyzing each type of plastic debris for its presence in the watersheds. We tested for

significant differences in mixtures of litter between watersheds and land uses. Based on these results, the individual watersheds were analyzed to determine land use differences in plastic debris and the dominant types of plastic. Data that was used for this analysis was covered at the beginning of this section.

## Plastic Composition in Watersheds and Land Uses

### Individual Assessment

When assessing our data for commonalities in types of plastic debris, we often found that the categorization of plastic differed from study to study. This made identifying consistently recurring types of plastic difficult. An example of the differences found between studies appeared when trying to identify food packaging items. While the Bight '13 study classified food packaging items into categories such as "wrappers/pieces," "cups/plates," and "lid/straws," the City of LA study used "snack and candy packaging" and "food service packaging" as categories to identify food packaging. This again differs in comparison to the Herondo Drain study

that used "foam-food," "hard-food," and "film-food" to identify food packaging.

In order to find overarching themes of plastic debris, we grouped data from our datasets into general categories and found that the four most common plastic debris items in our region of study were cigarettes, plastic bags, polystyrene, and food packaging items (Figure 5-13). Differences in plastic categorization also appeared in the metrics by which data was collected. The most common method was by count (i.e., number of pieces) and this metric was used for the following analysis as it applied to most studies. Other metrics, which were used sparsely, included weight, volume, and size.

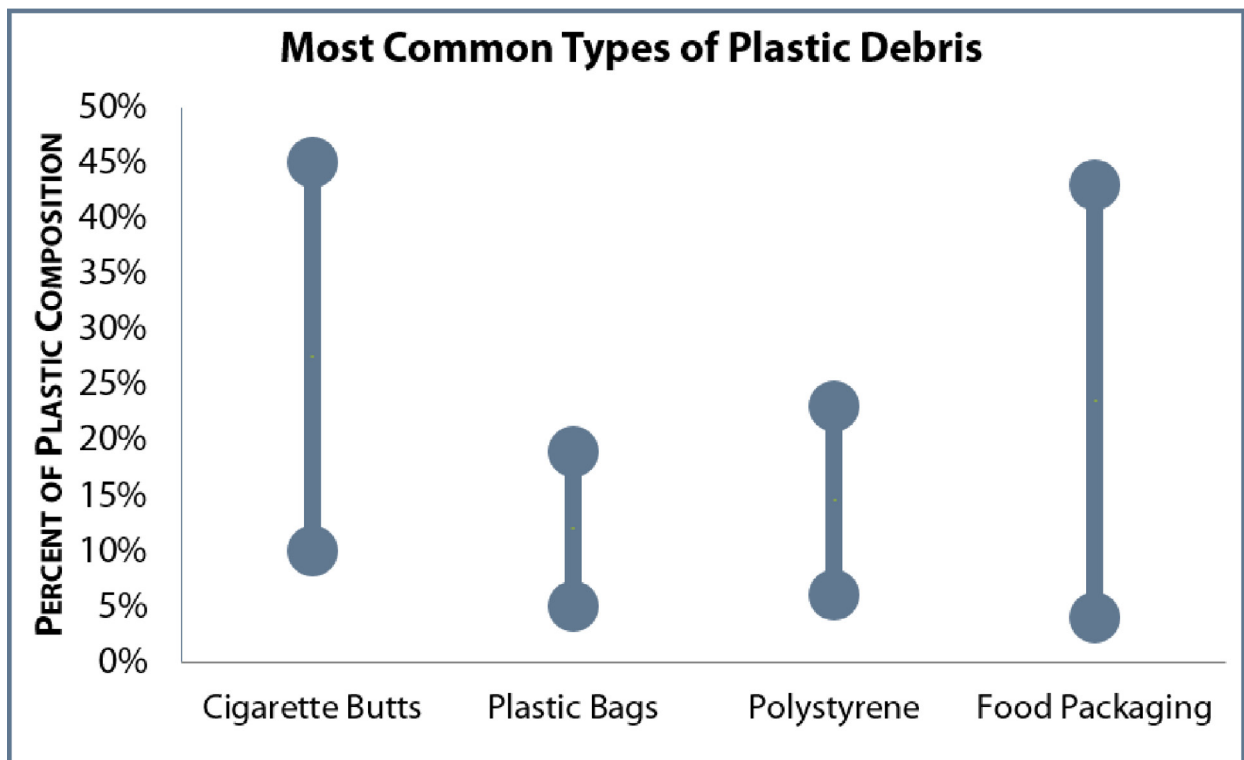

Figure 5-13 Percent composition ranges by count for the most common plastic debris types in our study region. Sources: Bight '13 (2011-2013), Fullerton Creek study (2013), TMDL Monitoring (2012), Herondo Drain (2009-2012).



---

As mentioned above, cross-dataset analyses made it difficult to ascertain common types of plastic due to differences in categorization and sampling practices. Plastic in the form of cigarette butts were one of the most common types of plastic debris. Although it was only a discrete category of plastic in two of the four studies (TMDL Monitoring (2012); Herondo Drain (2009-2012)), cigarette butts appeared in high quantities compared to other types of plastic debris (as high as 43% of plastic by count).

Plastic bags were another common type of plastic found in waterways. Accounting for between 5%-19% of the total plastic debris count, plastic bags are known to be single-use items that are often disposed of improperly. Their airy and lightweight nature makes them susceptible to wind transport into waterways, and their thin film properties allow them to be easily broken down into smaller fragments

Polystyrene is a plastic product that is often used in the food service industry and as a packaging material. Due to the variety of categories that appear in the data, it was somewhat unclear if specific types of plastic such as polystyrene were counted under different categories. For the purposes of our analysis, only data that was specifically labeled polystyrene was used for this category. Foamed food containers, which may be comprised of polystyrene, were not considered. The low density of polystyrene means it would not make up a large percentage of trash by weight, but it is one of the dominant types of plastic found in the waterways. Of the plastic found in LA and SG River Watersheds' trash studies, 6%-23% were polystyrene. Polystyrene is also

lightweight, making it transportable by wind, and easily broken down into smaller pieces in urban and natural environments.

Food packaging was one of the most prolific types of plastic debris across all of the studies. While this category is very broad and may include hard plastics, filmed plastics, and foamed plastics, the most common type of food packaging from the Bight '13 study was wrappers and wrapper pieces. This type of film plastic typically originates from single wrapped or packaged food items, such as chip bags or candy wrappers. Within the regions, food packaging plastic made up between 4% and 43% of the total plastic debris by count. Some of the most common types of plastic debris in this category include wrappers, containers, cups, and plates. These types of litter are often associated with fast food and picnic items used in open recreational areas. Foamed plastic food packaging is commonly found in the form of takeout containers.

There are many ambiguities associated with trash collection and characterization. Different organizations use different classifications and parameters for categorizing their data. There are difficulties in distinguishing polystyrene pieces, i.e., they could be from polystyrene takeout food containers or from polystyrene cups. Miscellaneous pieces of plastic are also large categories of plastic debris in many studies. This category may include smaller pieces of the more common plastic debris items, but this information was not captured in the collection and categorization process.

In contrast to the limited studies that have been done on riverine trash debris, there

---

have been many studies of litter on beaches. Differences between the types of trash that are found in beach studies relative to river studies yield information on the sources of different types of marine debris. In a study by Heal the Bay (2011), it was found that plastic films were the most common on beaches

### *Plastic Composition by Land Use*

Only two of the datasets we collected (Bight '13 (2011-2013) and TMDL Monitoring (2012)) included land use within the watersheds. Using these data, along with the Primer statistical package, we looked at the differences in composition of plastic debris between the LA and SG River Watersheds, as well as between urban and open land uses.

We first analyzed whether there was a statistically significant difference in the composition of trash between the LA and SG River Watersheds and land uses. Using the Bight '13 data, our most comprehensive dataset, we performed a preliminary 2-factor analysis with PERMANOVA. This test revealed no statistically significant correlation between the composition of litter between watersheds, but it did indicate that land use was correlated. We conclude that there are statistically significant differences in the composition of plastic debris between urban and open land uses in the watersheds. Urban land uses include residential, commercial, and industrial, while open land uses include parks and forests.

We next tested for statistically significant differences in patterns between land uses for each watershed, based on our hypothesis that a characteristic difference would appear between the open and urban regions of each

(~25% of plastic; ~19% of total trash). The next most common types of plastic were cups, wrappers, foamed plastic, and hard plastic, which accounted for approximately 17%, 14%, 8%, and 7% of all plastic debris, respectively. These findings suggest similarities between beach and river trash.

watershed. We divided the data, first by watershed and then by land use, into four categories. Similar to the quantity analyses described above, in both the LA and SG River Watersheds, we looked at urban and open land uses.

The least sampled area was the SG Watershed's urban space, which had 18 collection sites. In order to balance the data, the three other data categories were arranged by date and assigned a record number. Using Microsoft Excel's random number generator, data were removed from each category until only 18 sites remained. A PERMANOVA test was performed to compare the urban and open areas in the LA and SG River Watersheds to detect differences in the types of plastic. This test uses a Bray-Curtis similarity statistic to assess similarities or differences in composition.

Our test of the differences in the composition of plastic between land uses resulted in p-values of 0.001 and 0.002 for the LA and SG River Watersheds, respectively, meaning that there is less than a 5% chance that these are random results. We therefore conclude that there is a statistically significant difference in the composition of plastic across different land uses.

### *Important Plastic Types*

Analyses of the composition of trash relies on three factors: mixture, abundance, and frequency. To determine which factor correlated with the differences in composition found above, we did one more level of analysis. By transforming the data into a scheme of presence/absence, we eliminated the factor of abundance in the PERMANOVA analysis and confirmed the statistical significance found with our earlier analyses. With p-values of 0.001 and 0.002 for the LA and SG River Watersheds, respectively, we conclude that the presence, rather than the abundance, of different types of plastics are correlated with the differences between watersheds.

With this information, we then performed a SIMPER (similarity percentage) analysis

in order to identify which plastics were the most important in creating different compositional patterns of debris within the watersheds (Table 5-7). Plastic types with higher percentages contribute more to the compositional differences between watersheds. For instance, since “wrappers/pieces” have high percentages, those plastic types were more present in one land use versus another. In the LA and SG River Watershed, the plastic types that correlate with compositional differences in land use are: “Wrappers/pieces,” “Bags/pieces,” “Misc. Pieces,” and “Polystyrene/pieces.” As these are also the most common types of plastics, they are deemed high priorities for addressing the overall issue of plastic debris in the two watersheds.

**Table 5-7 Percent contributions to differences in composition of plastic debris in the Los Angeles and San Gabriel River Watersheds.**

Plastic Type	Los Angeles River Watershed % Contribution	San Gabriel River Watershed % Contribution
Wrapper/pieces	28.73%	32.91%
Bags/pieces	13.93%	21.59%
Misc. pieces	17.02%	15.23%
Polystyrene/pieces	25.92%	15.20%
Bottles	5.11%	4.53%
Container caps/pieces	2.68%	3.88%
Cups/plates	1.10%	3.13%
Lid/straw	1.11%	1.78%
Plastic other	4.09%	0.83%

Plastic Type	Los Angeles River Watershed % Contribution	San Gabriel River Watershed % Contribution
Pipe (PVC)	0.32%	0.60%
Tarp	0.00%	0.33%
Foam balls	0.00%	0.00%

SOURCE: BIGHT '13 (2011-2013).

While the same types of plastics correlate with the differences in composition between land uses, this analysis does not tell us whether a particular type of plastic is located primarily in urban or open regions. To analyze land use, we compared the breakdown of plastic debris for each watershed (Figure 5-14 and Figure 5-15).

In the LA River Watershed, we found that the most common types of trash were the same types that correlated with compositional differences in the ANOSIM analysis. This means that while they are the most abundant types, they were not spatially distributed and some were more prominent in open versus urban regions. One thing to notice

from Figure 5-15 is that within urban regions wrappers and miscellaneous pieces of plastic were the most prominent. Wrappers and wrapper pieces may be predominant in urban areas due to the urban sources of this debris. The majority of stores and convenience shops are located in urban regions and plastic associated with this is abundant. A possible explanation for the large amounts of fragmented pieces may be due to the Trash TMDL – with 5 mm mesh screens in catch basin inserts, small pieces were allowed to enter the waterways where these data were collected. In addition, larger pieces of plastic debris from the open, upstream regions may have time to break down before being deposited onto the urban riverbanks.

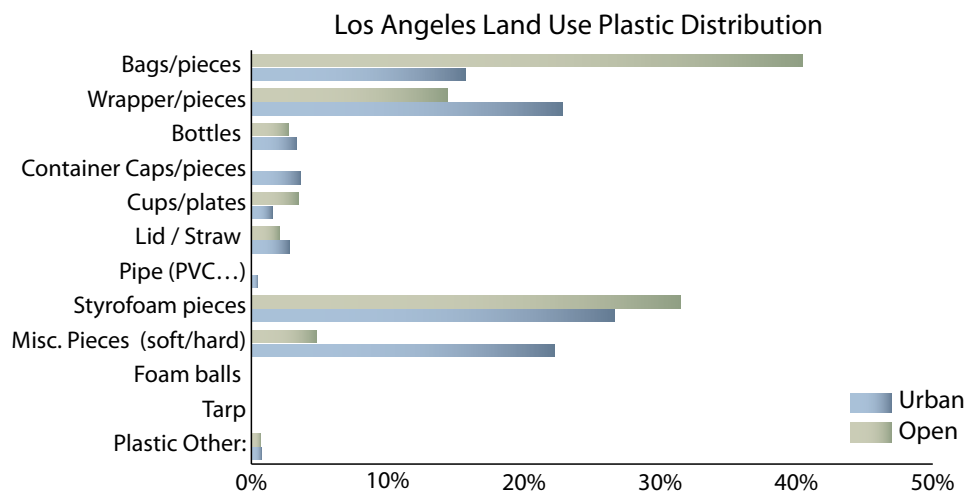

Figure 5-14 The percent plastic debris in the LA River Watershed by land use. Source: Bight '13 (2011-2013).



Specific types of plastic are also more abundant in open areas. Polystyrene (e.g., Styrofoam™) and plastic bags are commonly associated with picnicking and takeout food consumption, activities which are common in open recreational areas. Foam in the form of cups, plates, and even disposable

coolers, can be easily broken down into small fragments (allowing it to pass through catch basin inserts or transported by wind) and is present in both open and urban areas. Plastic bags used to carry items to open regions for recreational activities can be easily windblown.

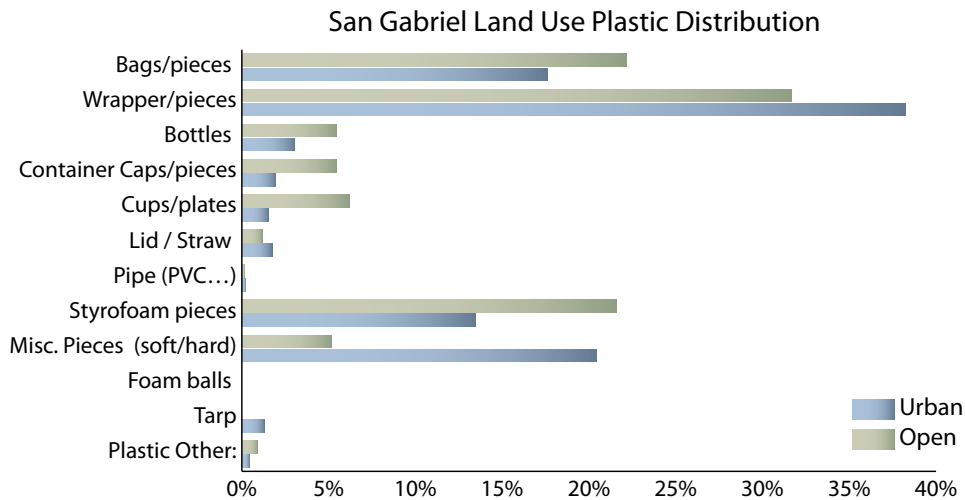
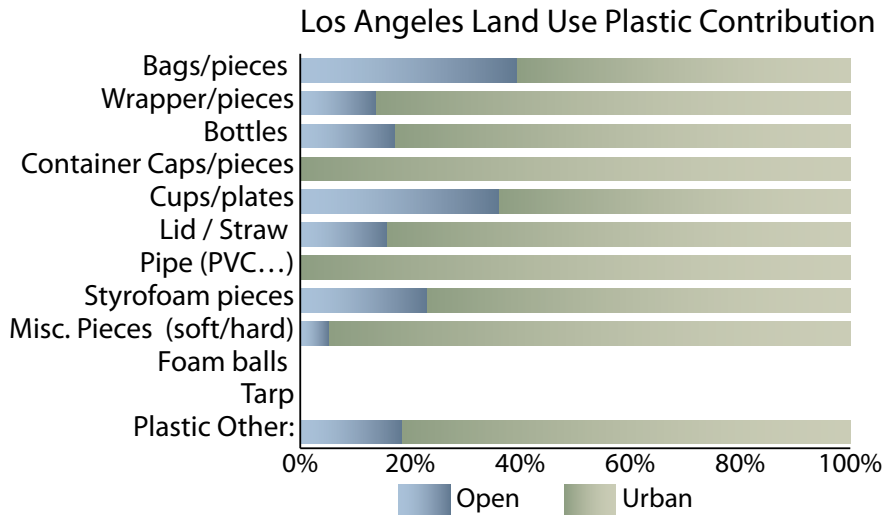

Figure 5-15 The percent plastic debris in the SG River Watershed by land use. Source: Bight '13 (2011-2013).

We see the same pattern of plastic distribution between urban and open areas in the SG River Watershed. There are a larger proportion of plastic bags and polystyrene in open areas and more wrappers and miscellaneous pieces in urban areas. The difference in the SG River watershed compared to the LA River Watershed is that the percent differences between open and urban land uses are typically smaller. These smaller differences between land uses may be due to the LA River Watershed Trash TMDL's positive effects at reducing plastic debris in urban areas, creating more disparity in plastic presence. However, in most categories,

there are larger percentages of plastic debris in open regions. This may be due to the recreational use in regions such as the East Fork San Gabriel River, as well as the lack of success of the current Trash TMDLs.

It should also be noted that while the composition of plastic debris is different between land uses, the abundance of each type of plastic is different for each watershed (Figure 5-16 and Figure 5-17). Urban areas, with their higher population densities, have more trash than open space, even if recreational activities are considered.

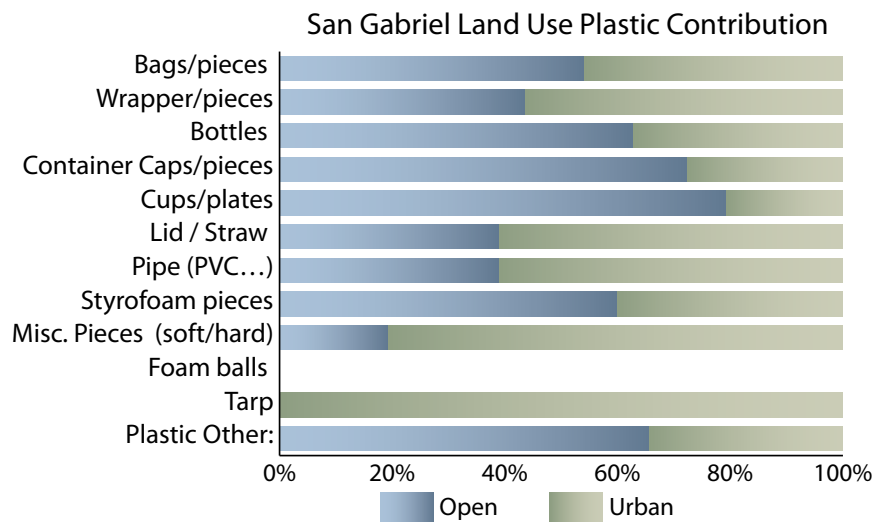

*Figure 5-16 The contribution of plastic debris per land use for each type of plastic debris in the Los Angeles River Watershed. Note that urban areas produce a larger percentage for all types of plastic. Source: Bight '13 (2011-2013).*

The SG River Watershed differs from the LA River Watershed in that its lower population density results in larger proportions of some types of plastic debris being generated in open areas rather than urban. This supports our previous analyses by explaining that while the distribution of plastic debris may be different between land uses, areas with dense urban populations

(such as Los Angeles) produce larger volumes of plastic.

Analyses of data collected in the SG River Watershed reveals that the items commonly found in open areas are food-related items, such as cups, straws, plastic bags, and polystyrene. This correlates with our hypothesis that open areas are a large contributor of plastic to the LA and SG Rivers.



*Figure 5-17 The contribution of plastic debris per land use for each type of plastic debris in the San Gabriel River Watershed. Note that urban areas produce a larger percentage for all types of plastic, Source: Bight '13 (2011-2013).*

---

We conclude that there is no statistically significant difference in the composition of plastic debris between the LA and SG River Watersheds, but differences do appear between land uses. The top four types of plastic that differentiate land uses are wrappers, bags, polystyrene, and miscellaneous pieces of plastic. Differences in the types of plastics present in open and urban regions may be a result of the LA River

Watershed Trash TMDL, but the open area Trash TMDLs in the SG River Watershed (East Fork and Legg Lake) do not appear to have a strong effect on the amount of plastic debris. These analyses allowed us to identify particular types of plastic debris as problem plastics, and gave us evidence to hypothesize about the effectiveness of open space Trash TMDLs.

### 5.2.4 PEOPLE LITTER – A LOT!

---

Trash that is improperly disposed of (i.e., litter) has the potential to end up on streets, in stormwater systems, and in waterways (EPA<sup>1</sup>, 2013; NOAA, 2008). Besides littering, improper disposal can occur where there is a lack of infrastructure to capture plastic debris, such as trash cans without lids, overfilled trash cans at events, public parks, recreational areas, and beaches (Ocean Conservancy, 2011). There are some studies that provide accurate quantitative measurements for trash released accidentally into the environment, but until very recently, plastic debris has not been broken out as a separate component, making source identification and quantification problematic (Stevenson, 2011; UNEP, 2011).

A national study conducted in 2009 by Keep America Beautiful found that overall litter

decreased by 61% since 1969 (Schultz et al., 2009). The researchers collected litter through the random sampling of 240 roadway sites and 180 non-roadway sites, across different land use types (e.g., rural, urban) and then performed multi-linear regression to correlate site attributes with observed litter. They attributed the decrease in litter to education and cleanup efforts. However, plastic litter increased by 165% in the same period (Figure 5-18). The shift from metal, glass, and paper packaging to plastic was cited as the reason for this dramatic increase in plastic litter. After highways, storm drains had the second-highest amounts of litter (Schultz et al., 2009). The largest source of litter was identified as highway littering (53%), followed by pedestrians (23%), improperly covered loads (16%), vehicle parts (2%), and overflow from trash receptacles (1%).

## Percent Change in Litter Since 1969

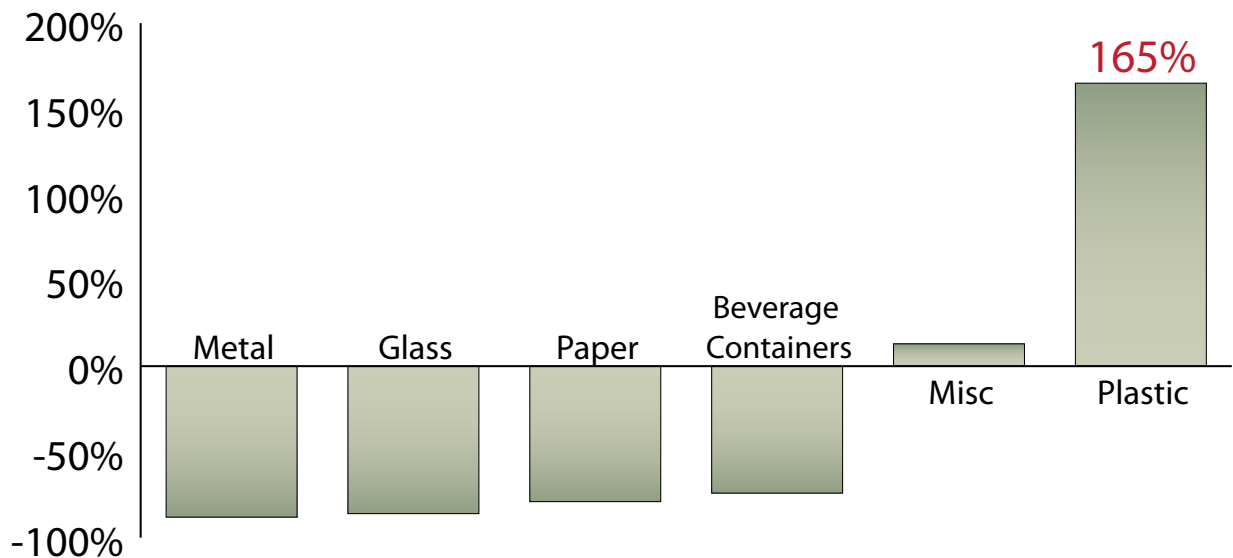

*Figure 5-18 Change in Litter since 1969. Source: Schultz et al. (2009)*

An action plan developed in 2006 for California to reduce land-based discharges of plastic debris into the environment determined that urban runoff was a primary source of marine debris (Gordon, 2006). The primary source of trash in urban runoff was found to be litter that was either intentionally or accidentally released (Gordon, 2006). The California Department of Transportation found that 43% of the litter trapped in California storm drains by catchment inserts was plastic (CDOT, 2011). Caltrans conducted a trash study along freeway catch basins in the Los Angeles region and found plastics to be 33% of the trash by weight (Lippner et al., 2001).

Volunteer cleanups in the Glendale Narrows portion of the LA River reported volumes of plastic in the trash from 47%-57% (Tyack, 2011). A 2011 Friends of the Los Angeles River trash cleanup effort conducted

along stretches of the LA River found plastic film (primarily single-use plastic bags and snack and candy wrappers) to be the most abundant item. Single-use plastic food packaging and polystyrene also ranked in the top five (Tyack, 2011).

These findings align with our own data analyses (discussed in detail in our "Assessing the Quantity And Characterization of Plastic Debris in the Watersheds" Findings section). Plastics as a percentage of total trash in the LA and SG River Watersheds made up 43%-70% of total trash by count. The most common types of plastic debris were cigarette butts, food packaging, polystyrene, and plastic grocery bags.

Littering on highways, the contribution of homeless encampments to the litter problem, the economic impacts of littering, litter law enforcement efforts, as well as educational outreach campaigns to deter littering behavior are discussed below.



---

## HIGHWAYS

---

Caltrans characterized litter by examining the contents of freeway catch basins in California during storm seasons over a two-year period (1998 to 2000) (Lippner et al., 2001). Moldable plastics represented the largest component, by weight and volume, of the trash collected and analyzed – cigarette butts were the

largest category, by count. The researchers pointed out, however, that identifying the source of the litter was limited due to the small sizes of pieces collected. The study also found that the vast majority (~80%) of the litter collected was floatable.



*PHOTOGRAPH COURTESY OF CALTRANS.*

Plastic food cartons, polystyrene, plastic cups, plastic utensils, plastic snack food wrappers, plastic sheets, and plastic film were all in the top 10 categories of items collected. Caltrans identified the major

sources of litter on highways as pedestrians, drivers, household garbage cans, commercial dumpsters, construction sites, loading docks, and uncovered trucks.

## HOMELESS ENCAMPMENTS

---

There is a dearth of quantitative information with respect to the overall contribution of homeless encampments to the litter problem. The meeting minutes of June 20, 2013 from a CalRecycle-established Illegal Dumping Technical Advisory Committee contain comments from Rob Hutsel, Executive Director of the San Diego River Park Foundation (CalRecycle, 2013). Hutsel reported that volunteers conduct 20 to 30 river cleanups annually, removing more than 1.5 million pounds of trash since 2004, 70% of which was attributed to homeless encampments along the San Diego River.

A 2012 study at the Fullerton Creek Watershed in Orange County found that the

close proximity to a freeway and homeless encampment were the major contributing factors to the increased levels of trash found at one transect (Furman, 2013). Plastic made up, on average, 48% of the total trash collected across all sites in this study (Furman, 2013).

According to a Los Angeles Times article, a field operations manager for the Department of Public Works reported that a single homeless encampment cleanup conducted in South Gate near Imperial Highway resulted in the removal of more than 100 tons of litter in December of 2010 (Zavis, 2010). There were approximately 10 people living in this encampment. The city reported that they had

only become aware of the encampment a few months prior to the abatement measure. It cannot be assumed that all 100 tons of this litter would have ended up in the LA River if it had not been removed during this abatement. However, the high volume of trash collected at this one site does suggest that homeless

encampments have the potential to lead to a higher percentage of trash ending up in the river. This ultimately affects the city's ability to comply with the LA River Watershed Trash TMDL that set a waste load allocation of ~2,800 tons per year for the watershed in 2007 (LARWQCB<sup>1</sup>, 2007).

### ECONOMIC IMPACTS

While the LA and SG River Watersheds have sophisticated waste management systems, recycling programs, and some composting facilities, a proportion of their waste stream still ends up on roadways, in rivers, and in lakes. Unless this debris is collected, it eventually washes out to the sea. The economic impacts associated with litter are significant.

One study estimated that communities with higher litter volumes experienced decreased property values from 7%-24% (Schultz et al, 2009). California's tourism and recreational economy has been estimated at \$43 billion annually (NOEP, 2005). Economic impacts

due to plastic litter and a decrease in the aesthetic value of beaches and shorelines have not been quantified for our study region. However, an accidental trash spill in New York in 1997 that affected New Jersey beaches resulted in an estimated \$1 billion in lost tourism revenues over a two-year period (COPC, 2008).

In California, municipalities currently spend approximately \$428 million annually related to waterway and beach cleanups, street sweeping, stormwater capture devices, storm drain cleaning and maintenance, manual litter cleanup, and public anti-littering campaigns (Stickel et al., 2013). Caltrans estimates that it

## The Cost of Litter:

### California

Waterway and beach cleanups, street sweeping, stormwater capture devices, storm drain cleaning and maintenance, manual litter cleanup, and public anti-littering campaigns ~\$428 million

Road and highway cleanups ~\$52 million

### County of Los Angeles

Street sweeping, catch-basin maintenance, litter prevention, educational outreach efforts ~\$18 million

Beach cleanup ~\$4 million

---

spends \$52 million annually to clean up litter from roads and highways (Stevenson, 2011). The County of Los Angeles, Department of Public Works, estimates that it spends \$18 million annually for street sweeping, catch-basin maintenance, litter prevention,

and educational outreach efforts (COPC, 2008). Beach cleaning efforts conducted by the County of Los Angeles cost an additional \$4 million per year to clean 31 miles of beaches, collecting more than 4,000 tons of trash (COPC, 2008).

### LITTER LAW ENFORCEMENT

---

In 2004, the Los Angeles Department of Public Works proposed an ordinance amendment to reduce the littering fine and turn to an administrative penalty approach rather than the current criminal approach in an effort to increase the level of enforcement (Harris, 2004). They made the case that the current litter laws were not being consistently enforced and that this action “might encourage better enforcement and compliance.” The report also states that, under the current status of litter law enforcement, the City of Los Angeles was failing to meet TMDL requirements for waste

entering the stormwater collection system (Harris, 2004).

In 2010, the Los Angeles City Council adopted a motion to develop this new “stepped-up citation program for littering” and requested that the Los Angeles Police Department report to them on the feasibility of such a program (Beck, 2010). The police department responded by stating that they felt the issuance of approximately 7,300 littering violations per year (in a city with a population of nearly 4 million people) was sufficient (Beck, 2010).

### ERASE THE WASTE CAMPAIGN

---

Litter that is not picked up through street sweeping, voluntary cleanups, and catch basin insert systems has the potential to be transported to rivers and eventually the ocean. The California State Water Resources Control Board launched a \$5 million, two-year, multi-media public awareness campaign for Los Angeles County in 2003 called “Erase the Waste” to address the problem of litter entering storm drains (California Water Boards, n.d.). Using a regression model developed by their Stormwater Program staff, Caltrans, and researchers from California State University, Sacramento, and University of California, Davis, they were able to

estimate the number of times that individuals engaged in littering activities. The model essentially reverse engineered the littering process using the litter volume found on freeways and expressways. Updated in 2007, the model estimated that in just one month litter was thrown on the ground or out of a car 830,000 times, blew onto a street more than 800,000 times, and ended up in a storm drain close to 280,000 times, in Los Angeles County (California Water Boards, n.d.; Syrek et al., 2003).

Los Angeles County also hired a marketing firm to analyze the LA population to assess the major polluting offenders and the sectors

---

that stood the greatest chance of changing their behavior (California Water Boards, n.d.; Pelegrin Research, 2004). The study identified three major population sectors, which they labeled “neat neighbors” (~50%), “fix-it foul-ups” (~13%), and “rubbish rebels” (~9%).

**2007 Los Angeles County Study Found that Litter:**

- **Was thrown on ground or out of a car 830,000 times**
- **Blew onto a street more than 800,000 times**
- **Ended up in a storm drain close to 280,000 times**

**... IN ONE MONTH!**

**18-24 year old males (9%) accounted for ~41% of total litter volume**

Neat neighbors were most likely to litter with cigarette butts and wash off their driveways. Fix-it foul-ups washed off their driveways and performed car and other maintenance in their front yards. The rubbish rebels were characterized as 18-24 year old males and accounted for approximately 41% of the total volume of litter (California Water Boards, n.d.; Pelegrin Research, 2004).

A follow-up survey conducted in 2004 showed statistically significant increased awareness of the problems associated with littering (and pollution) and the harm to marine environments that it causes, as well as a willingness to improve littering (and polluting) behavior (Pelegrin Research, 2004). The least affected sector for this marketing campaign was the rubbish rebels. The survey also found that littering behavior had declined since the baseline study conducted prior to implementation of the Erase the Waste campaign and effectively reduced the proportion of the total population that littered (Pelegrin Research, 2004).



---

## 5.2.5 MICROPLASTICS ARE AN EMERGING TYPE OF PLASTIC DEBRIS

---

### MICROBEADS AND MICROFIBERS

---

The use of microplastics in items such as facial scrubs (microbeads), which are washed off of the body into the shower drain, and polyester clothing (microfibers), which are washed out of clothes during laundering, has led to an increase of plastics entering wastewater treatment plants (WWTPs). These microplastics may then be discharged with the WWTP's effluent (Browne et al. 2011; Eriksen et al. 2013). Microplastics debris entering the environment are only now coming to the attention of the public and scientists – for example, there are no

studies that have measured the discharge of microplastics from WWTP effluent in the LA and SG River Watersheds.

We estimated these discharges by count and weight to understand the contribution of microplastics from WWTPs to the waterways. In our calculations, we used the concentration of microplastics per gallon of effluent (Browne et al., 2011), the average mass of a microplastic, and the effluent per day from each WWTP that discharges to the rivers in the watershed.

The formula for calculating each WWTP's discharge of microplastics, in count per year, is:

$$[5.7 \text{ microplastics per gallon of effluent}] \times [\text{WWTP effluent}]$$

The formula for calculating each WWTP's discharge of microplastics, in metric tons per year, is:

$$[5.7 \text{ microplastics per gallon of effluent}] \times (1.34 \cdot 10^{-11} \text{ mt per microplastic}) \times [\text{WWTP effluent}]$$

These values are derived from multiple studies. Browne et al. (2011) measured one microfiber of polyester per one liter of effluent (5.7 microfibers per gallon of effluent) from a WWTP in England with tertiary treatment. Eriksen et al. (2013)

weighed a microbead of plastic at 0.0143 mg. Various sources were used for the estimates of effluent per day in each of the WWTPs located in the LA and SG River Watersheds (Table 5-8).

*Table 5-8 WWTPs in the LA and SG River Watersheds and their estimated effluent per day.*

Wastewater Treatment Plant	Watershed	Effluent (Millions of Gallons Per Day)
Donald C. Tillman Water Reclamation Plant	LA River	54 <sup>a</sup>
Los Angeles-Glendale Water Reclamation Plant	LA River	15.5 <sup>b</sup>
Burbank Water Reclamation Plant	LA River	5.49 <sup>c</sup>
Whittier Narrows Water Reclamation Plant	LA River	15 <sup>d</sup>
Long Beach Water Reclamation Plant	SG River	19 <sup>d</sup>
Los Coyotes Water Reclamation Plant	SG River	22.5 <sup>d</sup>
Pomona Water Reclamation Plant	SG River	7 <sup>d</sup>
San Jose Creek Water Reclamation Plant	SG River	58 <sup>d</sup>

<sup>a</sup> (Headworks Inc., 2012)

<sup>b</sup> (City of Los Angeles, 2011)

<sup>c</sup> (Piasecki, 2013)

<sup>d</sup> (LACSD, n.d.)

It is estimated from our calculations that around a half billion microplastics will be emitted annually into the watersheds by the WWTPs (Figure 5-19). It should be noted that no empirical evidence of microplastics in WWTP effluent in the study region exists, and that this estimate contradicts our interviews with local WWTP personnel, who believe that microplastics are not in their effluent (see next section, “WWTP Interviews”). This total

represents 2 metric tons per year for the LA River Watershed, which is only about 0.07% of the total waste load allocation assigned in the LA River Watershed Trash TMDL. However, the susceptibility of microplastics to sorb pollutants and for animals to uptake the small pieces while feeding means that these plastics are likely to have a greater impact than their share of the total plastic debris weight in the watershed suggests.

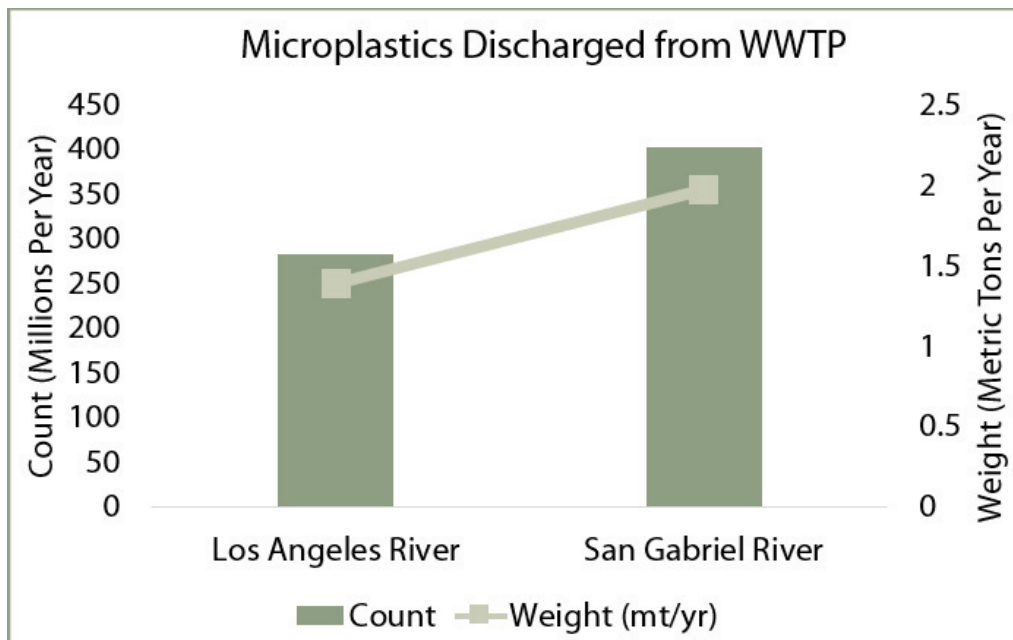

Figure 5-19 Estimates of microplastics discharged from WWTPs into the Los Angeles River and San Gabriel River in count and weight per year. There are four main WWTPs in each watershed that discharge into the rivers and their tributaries, Sources: Browne et al. (2011) and Ericksen et al. (2013).

Uncertainty is introduced into our calculations since a microbead and a microfiber are different types of microplastics; microbeads are spherical in shape, while microfibers are

long and skinny. While the microplastics may have different masses, limited scientific literature on each type meant that we used the only datum available (0.0143 mg).

## WWTP INTERVIEWS

We attempted to contact each WWTP in the watersheds by phone to ask a series of questions about microplastics. The questions asked were:

- Does your facility have any problems associated with microplastics?
- Are there any issues with matting due to microplastics?
- Is there a concern with pollutants sorbing on to microplastics that are then discharged into the effluent?
- What the fate of sludge was from their facility (the percentage that is sent to either soils or landfills)?

We interviewed the supervising engineer of the Sanitation Districts of Los Angeles County (which has jurisdiction over the Long Beach,

Los Coyotes, Pomona, San Jose Creek, and Whittier Narrows Water Reclamation Plants), the plant manager for the Burbank Water

---

Reclamation Plant, and a representative for the Donald C. Tillman Water Reclamation Plant. The answers from each WWTP were essentially the same for every question; they did not believe they had issues with microplastics in their effluent or matting from microplastics within the plant, and they were not worried about pollutants sorbing on to microplastics.

The Burbank Plant Manager mentioned how an object that is visible to the naked eye, such as a 0.1 to 1 mm microplastic, would be easily noticed during their daily water sampling. The Sanitation Districts Supervising Engineer elaborated on this point further by mentioning that their tests would easily detect pollutants that may sorb on to the microplastics. Given that neither representative had seen this occur, they did not believe microplastics to be a problem. The studies that have measured microplastics in effluent, and the disparity with the reported absence of microplastics by the operators of WWTPs in the LA and SG River Watersheds, demonstrate the need for in-situ measurements in the watersheds.

The Burbank Plant Manager said that he had never heard of microplastics being a problem for a WWTP, and that his best guess was that if microplastics were entering the facility, they would settle into the biosolids. The representative for the Tillman plant also echoed the likelihood that the microplastics ended up in the biosolids. The biosolids for the Tillman, Burbank, and Glendale plants are sent to the Hyperion Treatment Plant, a large WWTP located in Los Angeles that discharges directly into the Pacific Ocean. In 2012, the biosolids from the Sanitation Districts of Los Angeles County WWTPs were used for application to soils, fuel generation, lime stabilization, and storage in landfill (LACSD, 2013). Over half (55%) of the biosolids were applied to soils, while the majority of the rest (38%) ended up in landfills. If microplastics entering WWTPs are finding their way to the biosolids, it is likely that the majority of those microplastics are then entering the environment by application to soils. This has also been noted in the scientific literature, but no studies on the concentration of microplastics in biosolid-applied soil were identified (Zubris et al., 2005).



---

## 5.2.6 INDUSTRY PLAYS A ROLE IN THE PLASTIC DEBRIS PROBLEM

---

The quantity of plastic that exists in the environment is dependent on the amount of plastic that is produced. With the global quantity of produced plastic on the rise since its development in the early 1900s, it is no surprise that plastic trash in the environment is of growing concern. Plastic's resilient nature allows it to be persistent for long periods of time without completely decomposing, but instead breaking down into smaller and smaller pieces.

### Global Plastic Production

- **~5% annual growth rate since 1990's**
- **Packaging makes up 33%-42% of total**
- **U.S. generated 32 million tons of plastic in 2011**

Plastic production over the last 20 years has increased by an average of 5% per year (Plastics Europe, 2013; UNEP, n.d.); 32 million tons of plastic were generated in the U.S. in 2011. Packaging was the largest component, with over 12 million tons of plastic produced. Consumer products were the second largest category of plastic production at 7 million tons (ACC, 2013; EPA<sup>2</sup>, 2013).

In March 2011, the Society of Plastics Industry (SPI), the American Chemistry Council (ACC), and other plastic organizations across the world signed the Declaration of the Global Plastics Associations for Solutions on Marine Litter (GPA, 2011). As the name of the Declaration states, the goal is for the

plastic associations, and the companies they represent, to find ways to reduce marine plastic debris. The Declaration identified six areas that the plastic organizations would focus on to reduce plastic debris: education, research, public policy, best practices, recycling and recovering plastics, and plastic pellet containment (GPA, 2011). In a December 2012 progress report, 58 plastic associations across 34 countries were recognized as having signed the Declaration (GPA, 2012). Additionally, 140 projects to reduce plastic debris that were planned, underway, or completed, were identified as fulfilling the Declaration (this works out to slightly more than 2 projects per participating plastic association). According to the progress report, this was a nearly 50% increase in the number of projects since the announcement of the Declaration. No quantifiable results were presented in the Declaration or the progress report.

The manufacture and sale of new plastic products maintains a steady stream of plastic debris that enters the environment, and while global efforts to reduce the impact of plastic debris have been increasing, they do not seem to be keeping up with the increase in production. Single-use plastic packaging, preproduction plastic pellets (the raw material used in plastic production), the Industrial Storm Water General Permit implemented to prevent the discharge of plastic pellets to the LA and SG River Watersheds, the results of a plastic facility industry survey conducted by the State Water Board, and the U.S. plastics industry's voluntary best management practice (BMP) program for plastic facilities, are discussed below.

---

## SINGLE-USE PLASTIC PACKAGING

---

Single-use plastic packaging includes items such as plastic grocery bags, candy and food wrappers, beverage bottles, polystyrene (often in the form of takeout food containers), cups, lids, straws, and utensils. Many of these items end up as litter, some of which makes its way to the LA and SG Rivers and, ultimately, the Pacific Ocean.

As discussed in the “Sources of Plastic Debris are Well Understood” Findings section,

single-use plastic packaging consistently ranks as one of the highest types of plastic debris in terms of abundance (Stevenson, 2011; Ocean Conservancy, 2011; WSI, 2011). The U.S. Plastics industry identified packaging as 42% of their total production in 2012 (ACC, 2013). Our data analyses aligned with these findings. Food packaging consistently made up a large amount of plastic debris across all of the datasets we analyzed (see “Plastic Debris Characterization” Findings section).

## PREPRODUCTION PLASTIC PELLETS

---

Industry and manufacturing processes involve the use of raw materials in the form of plastic resins, powders, and preproduction pellets. Preproduction pellets (commonly called nurdles) are the raw materials used to form or mold plastics for a multitude of commercial products (Arthur et al., 2008; Barnes et al., 2009; Derraik, 2002; McDermid et al., 2004).

Preproduction pellets are thought to enter the environment mainly through accidental spills during transport or handling (Arthur et al., 2008; Derraik, 2002; EPA, 1993; Moore, 2013). Rail yards have been identified as a potentially significant source of preproduction plastic pellet loss, especially during rainfall events (Gordon, 2006; Stevenson, 2011). Rail yards are used to store railcars before they are offloaded. According to the Santa Ana Regional Water Quality Control Board, accidental spills occur fairly often during offloading due to vacuum pump failures and leaks from hoses used to suck the pellets out of the rail car and into a transport container (A. Fischer, Personal Communication, September 3, 2013). The rail ballast surface is not conducive to cleanups (the pellets cannot be easily swept or vacuumed up after a spill occurs). These

spilled pellets accumulate over time and are washed out with runoff after rainfall events due to their buoyant properties. The U.S. plastics industry reports that rail transports 53% of total preproduction plastic pellets (ACC, 2013). Preproduction plastic pellets ranked highest in abundance in a beach trash characterization study conducted on Orange County beaches in 1998 (Gordon, 2006).

The abundance of preproduction plastic pellets in rivers, on beaches, and in the ocean is understudied but an area of emerging research. Even if the abundance were found to be low with respect to other plastic debris that makes its way into the environment, studies on the impacts of these small plastic particles reveal a growing concern. Once released into the environment they are nearly impossible to clean up. Many marine wildlife species mistake plastic pellets for food. Small plastic particles have been shown to sorb toxins that have already been released into the marine environment. These impacts are discussed in detail in the “The Impacts of Plastic Debris are Fairly Well Understood” Findings section, above.

---

## INDUSTRIAL GENERAL STORMWATER PERMIT MONITORING

---

California is currently using a 1997 Industrial General Stormwater Permit to regulate stormwater discharges from industrial facilities. This permit includes preproduction plastic pellets under the definition of “significant materials” and no discharge of significant materials is allowed (SWRCB, n.d.). Revisions to the 1997 Industrial General Stormwater Permit have been under development since 2005 and will go into effect on January 1, 2015 (SWRCB, 2012).

According to this revised permit, facilities must ensure that “waste, garbage, or floatable debris is not discharged into receiving waters” (SWRCB, 2012). The new permit also includes a section on preproduction plastic (SWRCB, 2013). Facilities that handle preproduction plastic must implement a containment system with a 1 mm mesh at each on-site storm drain location. If a containment system is not feasible, the facility must implement a suite of Best Management Practices (BMPs) aimed at achieving the same amount of containment as a 1 mm mesh. These BMPs include using properly sealed containers, using capture devices during transfer of preproduction plastic, and having a vacuum for quick cleanups in case of a spill (SWRCB, 2013). Facilities can be exempt if all of their preproduction plastic handling activities (storage, transfer, processing) are handled inside (SWRCB, 2013). The new BMPs are based off language from AB 258, a California bill focused on preproduction plastic that passed in early 2007, which added Chapter 5.2, Section 13367 to the Porter-Cologne Water Quality Control Act (PCWQCA,

1969). These BMPs are general because there are a wide variety of preproduction plastic handlers covered under the Industrial General Stormwater Permit that have drastically different industrial practices (D. Seidner, personal communication, July 9, 2013).

These permits are self-monitored and reported to the State and Regional Water Boards. To ensure proper compliance and reporting, the State and Regional Water Boards conduct on-site inspections. When inspecting industrial facilities, the State and Regional Boards have the authority to issue violation notices for poor management practices that may lead to a preproduction plastic spill; it is not necessary for a spill to have occurred (D. Seidner, personal communication, December 5, 2013).

According to the State Water Board’s 2012 Resource Alignment Plan, their goal is to inspect 10% of industrial facility permittees, 20% of Phase 1 MS4 permittees, and 5% of Phase 2 permittees annually (SWRCB, 2012). However, in the 2011-2012 fiscal year, the State Water Board only met 64% of its total inspection goals (SWRCB, 2013). A possible explanation is that the State and Regional Water Boards suffer from a lack of funds for the personnel hours required to conduct inspections, as each industrial inspection may take between 3 to 59 personnel hours and between 1 to 385 personnel hours for enforcement (A. Fischer, Personal Communication, September 3, 2013; D. Seidner, personal communication, July 9, 2013; C. Boschen, personal communication, July 1, 2013; SWRCB, 2012).

On the regional level, for the 2011-2012 fiscal year, the LARWQCB exceeded its goal of inspecting 200 out of the 2,730 industrial stormwater permittees under its jurisdiction

by inspecting 387 facilities (SWRCB, 2012). According to the State Water Board’s website, there were no compliance and penalty actions undertaken for any of these facilities.

## PLASTIC FACILITIES INDUSTRY SURVEY

The Preproduction Plastic Production Division of the State Water Board issued an industry survey in late 2009 that was circulated to 655 selected facilities (Seidner, 2010). The goal of the survey was to learn more about the handling of preproduction plastic materials. A preliminary analysis of the survey responses was conducted in 2010 and a draft report was prepared. The raw data were quality checked by Water Board staff. The results reported here are derived from a summary of our own analysis of this raw data (see Appendix G for the full report).

A total of 438 valid responses were received by early 2010, representing a 67% response rate. Out of these respondents, 54% reported

that their business involved the handling of pre- or post-production plastic in either pellet, resin, or powder form. Highlights of the survey results are reported below.

High- and low-density polyethylene make up the majority of polymers used (Figure 5-20). 47% of respondents used the “other” category – suggesting that there are other polymer types that could have been included in the choices. Polyethylene is used to make plastic film, detergent bottles, milk jugs, water and chemical barrels, plastic grocery bags, food storage bags, cling wrap, and insulators in electrical cables (Plastics Europe, n.d.).

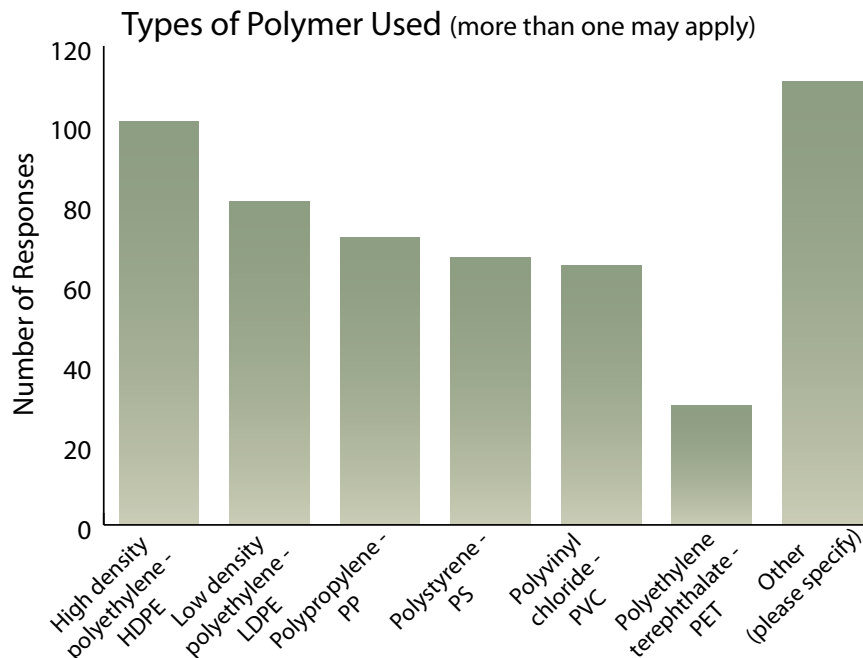
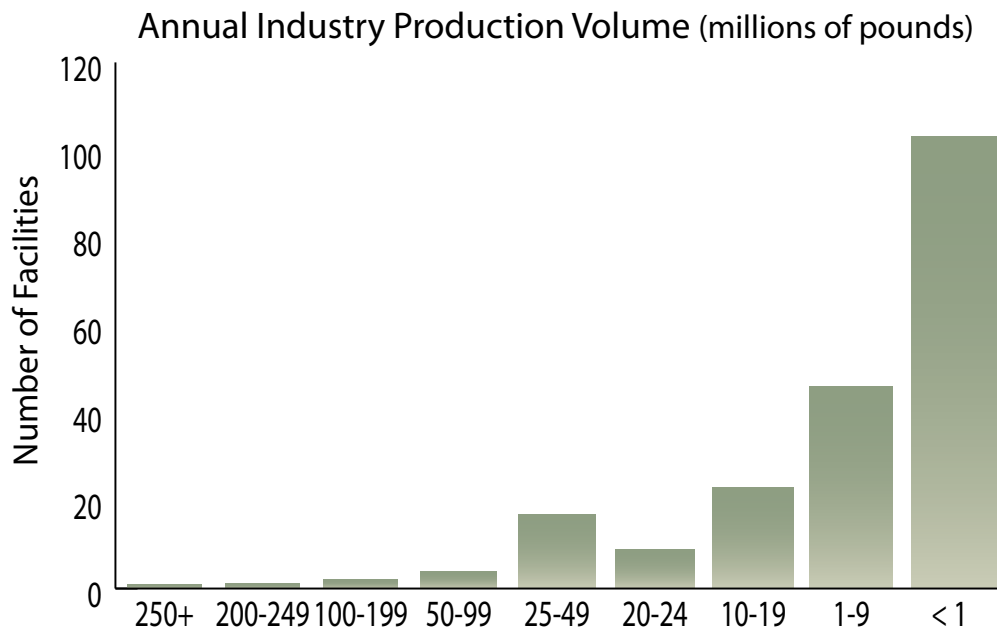

Figure 5-20 Types of polymers used. Source: 2009 Industry Survey, SWRCB



The survey also revealed that plastic facilities throughout the state are dominated by small-volume processors (Figure 5-21). This is important because the large number of small producers makes identification, monitoring, and enforcement more difficult (A. Fischer, Personal Communication, September 3, 2013; D. Seidner, personal communication, July 9,

2013; C. Boschen, personal communication, July 1, 2013). Many of these small producers fly under the radar of State and Regional Water Board staff due to their transient nature; they often pick up and move to a new location if they fall under scrutiny. They may also lack the financial and human resources to implement effective BMPs.



**Figure 5-21 Industry production volume. Source: 2009 Industry Survey, SWRCB**

Common spills occur under or near processing equipment, followed by areas where hoppers or silos are filled or emptied. Routine operational spills are cleaned frequently. Accidental spills occur infrequently. It should be noted that this is in direct contradiction to reports of commonly accepted and frequent spills through our interviews with State and Regional Water Board staff (A. Fischer, Personal Communication, September 3, 2013; D. Seidner, personal communication, July 9, 2013; C. Boschen, personal communication, July 1, 2013; SWRCB, 2012).

The most commonly cited cause of accidental spills was loading, unloading, and handling

procedures. The majority of facilities have outdoor loading docks and indoor hoppers and silos. Truck freight is the most common form of material delivery and shipments mainly occur multiple times per week.

Gaylords or bulk boxes are the most common form of material packaging. Packages arrive broken or leaking less than once per year. The majority of facilities reported that packages are broken or spilled during handling or unloading less than once per year. Respondents also reported that connection of vacuum feed lines to hopper cars rarely causes material leakage. The top common spill-prevention and response procedure was cited as immediate cleanup (Figure 5-22).

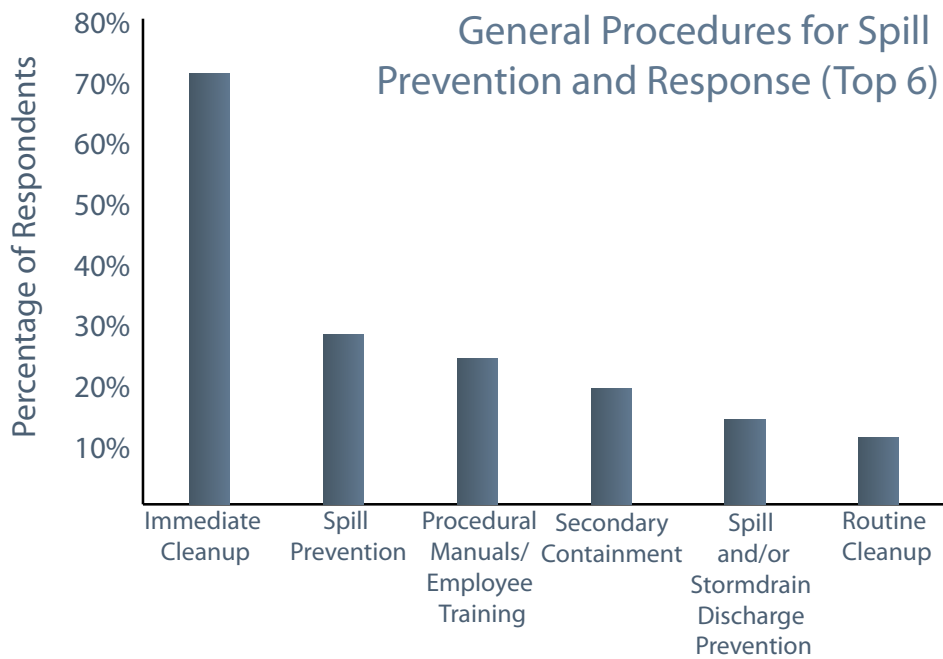

**Figure 5-22** General procedures for spill prevention and response. Source: 2009 Industry Survey, SWRCB.

The most commonly implemented BMPs are routine housekeeping and immediate cleanup, the use of a broom for cleanup, employee training on release prevention

measures, the use of a vacuum for cleanup, and employee education on the environmental hazards of the materials (Figure 5-23).

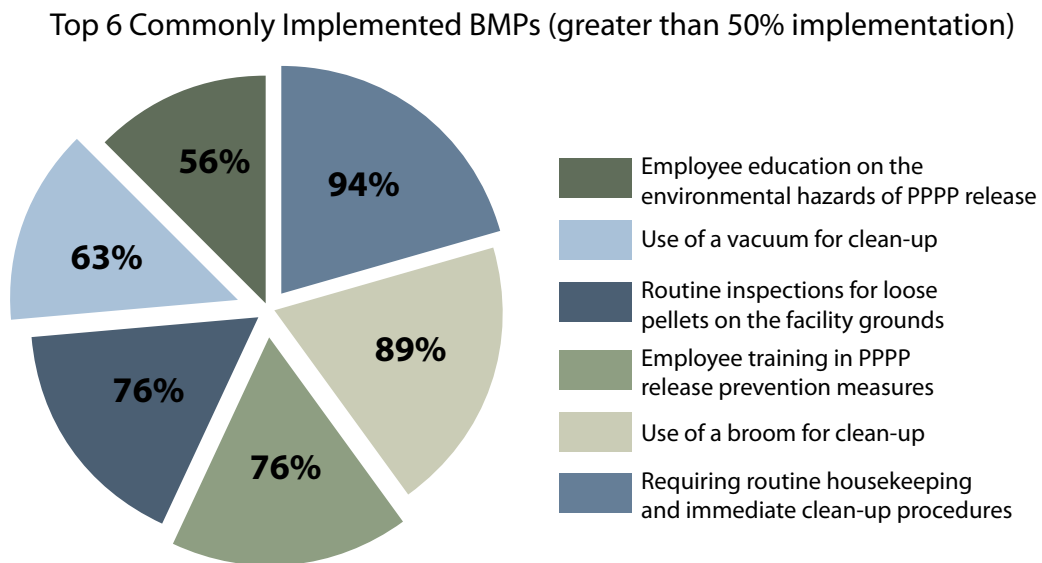

**Figure 5-23** Commonly implemented best management practices. Source: 2009 Industry Survey, SWRCB

---

Overall, the industry considers routine cleanup as the most effective BMP, followed by employee training and awareness, and routine inspections. Mat installations to prevent tracking material outdoors are considered the least effective BMP, followed by alarm alerts when spills occur. More than two-thirds of the respondents reported implementation of containment systems designed to prevent material discharge

into storm drains or waterways. Plastic is designated as a pollutant in the majority of their Stormwater Pollution Prevention Plans.

While this survey is informative, it was not conducted anonymously. As such, it is likely that some underreporting occurred, especially with respect to questions about spill frequencies and implementation of BMPs.

### OPERATION CLEAN SWEEP

---

The plastics industry has initiated policies to reduce plastic debris. The Society of Plastics Industry (SPI) created a set of voluntary BMPs in 1991 to reduce preproduction pellet loss, called Operation Clean Sweep (OCS). The Plastics Division of the American Chemistry Council joined OCS in 2004. The goal of these BMPs is a combination of reducing pellet loss from occurring in the first place, as well as practices to reduce pellet loss to the storm drains after spills. These BMPs were updated in 2005, with the assistance of SPI, AMRI, and the LARWQCB, after new attention was brought to the problem of pellets making their way to rivers, beaches, and the ocean from industrial sites. Being a participant in OCS does not require any measurement of pellet loss and reduction. SPI believes that adding a layer of complexity with measurements would make it more difficult to get facilities to join the program (P. Long, personal communication, July 19, 2013).

The only direct quantification of the effectiveness of OCS was a study conducted by AMRI along the LA and SG Rivers. This study found that when OCS BMPs were implemented across 10 plastic industrial

facilities, the amount of pellet runoff to storm drains was reduced by 57% (from 221,139 pieces of plastic debris to 93,325 pieces), although this varied widely across each facility (Moore et al., n.d.). The amount of pellets that could potentially be transported to the waterways (i.e., pellets found on the ground that could be mobilized by water or wind) was reduced by 75% (Moore et al., n.d.). While these numbers potentially show that these BMPs are effective, there was still significant pellet loss (Moore et al., n.d.). Additionally, each facility knew that AMRI would return to measure the changes in pellet loss. Therefore, these sites may have initiated OCS practices solely because they were being monitored and it may not be representative of plastic facility operations as a whole.

The State Water Board survey discussed above found that only 13% of the respondents were enrolled in OCS (Figure 5-24), despite the program's existence for over 20 years. Additionally, according to the OCS website, only 8 companies in the LA River Watershed and 4 companies in the SG River Watershed have signed the pledge to become an OCS program partner and implement the BMPs

---

at their sites. Although the exact number of plastic facilities that handle preproduction plastic in the region is unknown, we estimated that there are approximately 200

(using SIC codes). We therefore consider participation in the OCS program to be low for facilities located in the LA and SG River Watersheds.

## Operation Clean Sweep Participation

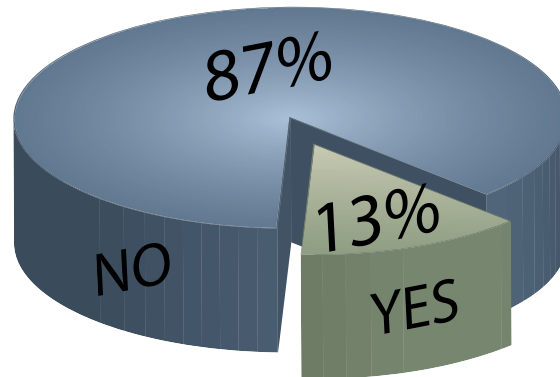

*Figure 5-24 Operation Clean Sweep participants. Source: 2009 Industry Survey, SWRCB*

---

## 6 RECOMMENDED ACTIONS TO REDUCE PLASTIC DEBRIS

---

Sixteen action items to reduce plastic debris in the Los Angeles and San Gabriel River Watersheds (LA and SG River Watersheds) were developed using the sum of our knowledge gained from our research. These action items were selected based on our findings and their potential to reduce plastic debris. Given that the implementation of all 16 action items is unlikely, we ranked each item by feasibility and effectiveness (Figure 6-1).

For *feasibility*, we used criteria of political and economic feasibility. An action item was considered politically feasible if a similar item had been implemented in a similar situation before, or if there were few legislative steps to implementation. An action item was considered economically feasible if the costs of the action were low, if a similar policy with similar costs had been implemented, or if the policy generated revenue.

*Effectiveness* was based on our understanding of the likely impact on reducing plastic debris.

An action item was considered effective if previous studies showed the efficacy of that action at reducing plastic debris. Sometimes this information was not readily available, and our collective judgment was used to estimate the action item's effectiveness.

We do not consider the individual rankings to be as significant as the general groupings of these action items, which we split into three tiers of importance. For example, the fact that the new San Gabriel River TMDL is ranked slightly lower in feasibility than Litter Law Enforcement and Education is not important given the somewhat subjective nature of the rankings. It is instead important that these two items (and the other three Tier 1 items) are clearly more feasible and effective than the other policies. Given the limitation of resources for implementation, we recommend that policymakers focus first on our Tier 1 Action Items.



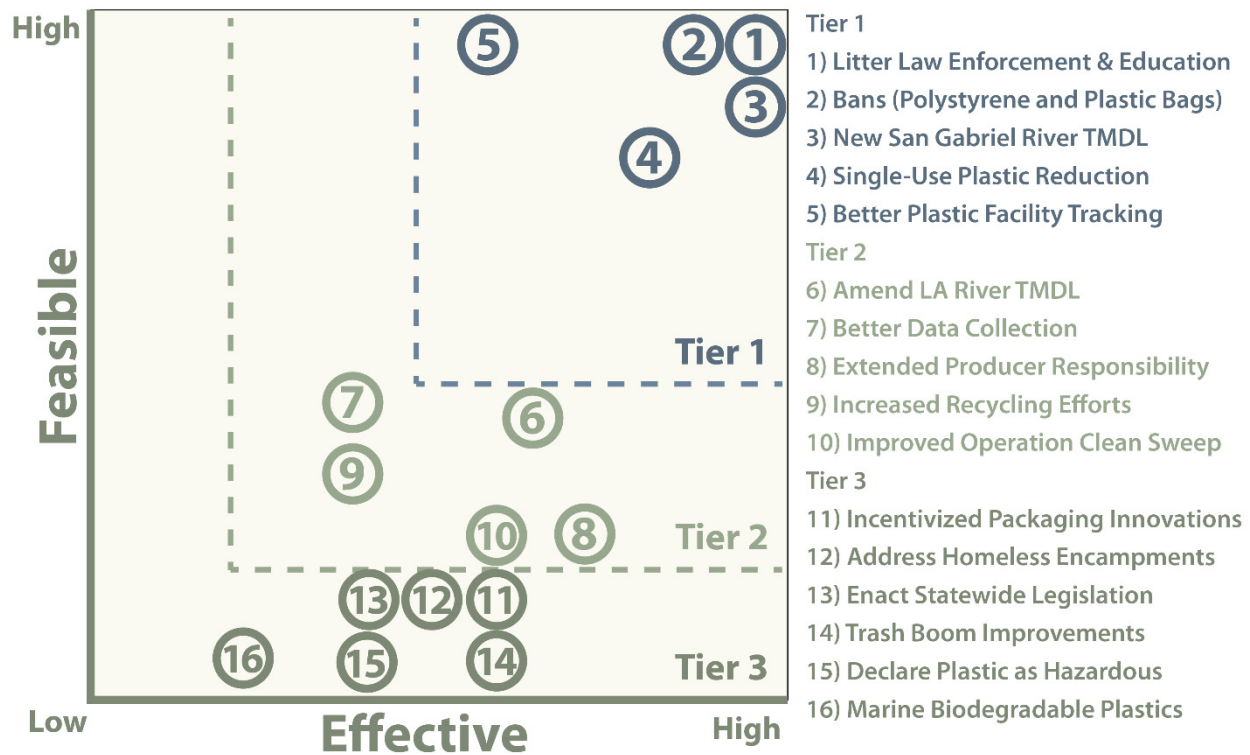

Figure 6-1 Policies to reduce plastic debris, ranked by feasibility and effectiveness.

## 6.1 TIER 1 ACTION ITEMS

### 6.1.1 LITTER LAW ENFORCEMENT, OUTREACH, AND EDUCATION

#### Recommended Actions:

- Implementation of civil administrative penalty enforcement
- Continuance of Erase the Waste campaign
- Continued educational outreach (primarily in K-12)

#### CURRENT LITTER LAW ENFORCEMENT

Laws that prohibit littering already exist. Under the California Penal Code, Section 374.3, a fine of up to \$1,000 may be issued for littering on highways. Despite these laws, littering is still a major contributor to roadway trash, as discussed in the “People Litter – A Lot!” Findings section.

We believe most of the problem lies in a lack of enforcement. The Los Angeles Police Department issues littering citations to approximately 0.18% of the total population of the Los Angeles metropolitan area annually (Beck, 2010). Given the volume of litter reported on Los Angeles freeways

---

alone (millions of pieces of litter are thrown out of cars on a monthly basis) this does not appear to meet the standard of sufficient enforcement. In addition, littering on

highways is only part of the problem. People frequently litter on city streets, in parks and recreational areas, as well as on beaches and along rivers.

### CIVIL ADMINISTRATIVE APPROACH TO LITTERING ENFORCEMENT

The question also remains as to whether it would be more effective to increase or decrease littering fines. The California Ocean Protection Council argues for increasing fines and using a portion of the revenues to pay for litter cleanup programs (COPC, 2008). The Los Angeles Department of Public Works, Bureau of Street Services argues for a lesser fine of \$50 (with increases for repeat violators) to encourage better enforcement that falls under civil administrative rather than criminal law (Harris, 2004). They propose that littering violations be issued by street use officers, relieving the majority of the burden on police officers tasked with addressing criminal behavior. It was unclear from the documentation whether this would entail the development of a new task force or that such officers already exist within the agency that

would take on this additional responsibility (Harris, 2004).

There are numerous advantages to a civil administrative approach. First, it reduces the burden on police officers to enforce all but the most egregious of littering activities. Second, it allows local municipalities to collect the fines and use a portion of those monies to fund litter cleanups, public awareness campaigns, increased trash receptacle locations, and garner community support at a local level. Third, the system ties in well with already existing laws that require property owners (including businesses) to keep their property free of litter. Finally, the appeals procedure for an administrative violation does not require that the issuing officer appear in court or take up the time of the City Attorney's office.

### EDUCATION AND AWARENESS CAMPAIGNS

Education and awareness campaigns must be ongoing and designed to engage the most common offenders. The most recent anti-littering campaign sponsored by Los Angeles County, "Erase the Waste," was designed to target these offenders. The campaign has resulted in an overall reduction of littering since its inception, but this type of multi-media messaging must be repeated often and over time to ensure its continued effectiveness (Pelegrin Research, 2004).

The "Erase the Waste" campaign should be continued and funded through littering fines.

Schools (especially elementary schools) should fully integrate anti-littering education into their environmental education curriculum (COPC, 2008, California Water Boards, n.d.). A portion of littering fines should be allocated to school districts to fund these educational programs.

---

## 6.1.2 BANS ARE NECESSARY: PLASTIC GROCERY BAGS AND POLYSTYRENE

---

### Recommended Actions:

- **Implement ban on plastic grocery bags**
- **Implement ban on polystyrene**

The debate over whether to implement bans, levies, point-of-sale fees, or launch public awareness campaigns on plastic products that are harmful to the environment continues. All have been shown to be effective (to varying degrees) at reducing the amount of a

product that ends up either in landfills or the environment. For reasons discussed below, we recommend the implementation of bans on plastic grocery bags and polystyrene (e.g., Styrofoam™) products.

### PLASTIC GROCERY BAG BANS

---

Numerous government agencies and nonprofit groups support source-reduction strategies that include outright bans on plastic products that pose a significant threat to the marine environment where there are cost-effective and suitable substitutes available (COPC, 2008; Gold et al., 2013; Kershaw, 2011; NOAA, 2008; Ocean Conservancy, 2011; Romanow, 2012; Stevenson, 2011; UNEP, 2005; UNEP, 2006).

“Paper or plastic” has been the ongoing debate for decades. We suggest that the debate is misplaced: neither is a good option. The best option is reusable bags, and the best way to get people to use them is to make them the most cost-effective option for consumers. Bans, levies, and point-of-sale fees could all accomplish this goal. However, the debate, at least for California, was resolved when the State Assembly passed AB 2449 in 2007 (AECOM, 2010). AB 2449 requires large retailers to make reusable grocery bags available for purchase

and provide containers for consumers to recycle plastic grocery bags. The bill also prohibits local municipalities in California from imposing a levy on plastic grocery bags. This leaves bans as the only option for policymakers at the local level to reduce the use of plastic grocery bags.

The Ocean Conservancy published a 25-year summary of their global trash collection efforts in 2011 and single-use plastic grocery bags ranked sixth in the top ten debris items collected (Ocean Conservancy, 2011). It is estimated that stray plastic grocery bags account for 1%-3% of litter worldwide. These stray bags end up in our oceans, clog sewer drains, and become eyesores in trees, fencing, and on our beaches. Stray plastic grocery bags are now found nearly everywhere, even in largely uninhabited areas like Antarctica (Environmental Literacy Council, 2008).

The sheer volume of plastic grocery bags that are produced, used, and discarded is a direct effect of increased population in a region.

The more people, the more bags consumed and, in many cases, thrown away after one or perhaps two uses. An urban environment encourages the use of plastic bags as an inexpensive way to transport the products we purchase. Annual usage estimates for plastic grocery bags range anywhere from 500 billion to 1 trillion worldwide (American Plastic Manufacturers, 2008; Environmental Literacy Council, 2008; WorldWatch Institute, 2008). This wide disparity is the result of a lack of verifiable statistics. The plastics manufacturers do not break out their sales (at least publicly) to reveal the total volume of plastic grocery bags they sell annually. Data from retailers who purchase the bags are scattered and not summarized in any meaningful form.

It is estimated that U.S. consumers dispose of roughly 100 billion plastic grocery bags every year and that only 0.6% of those plastic grocery bags are recycled (WorldWatch Institute, 2008). This recycling figure is disputed by other sources, with figures ranging from 1%-17% (the higher recycling

rates coming from reports prepared by or on behalf of the U.S. plastics industry) (American Plastic Manufacturers, n.d.; Environmental Literacy Council, 2008; WorldWatch Institute, 2008). Los Angeles County landfill operators estimate they spend approximately \$25,000 per landfill annually gathering single-use plastic grocery bags that are lost during collection, transport, or at the facilities, despite their implementation of BMPs such as truck covers and fencing at facilities (LACDPW<sup>2</sup>, 2007). Additionally, our assessment of regional datasets placed plastic bags as one of the top five most numerous types of plastic, making up 5%-25% of the plastic debris (see "Assessing the Quantity And Characterization of Plastic Debris in the Watersheds" Findings section).

Globally, numerous countries have addressed the issue of plastic grocery bag usage in a variety of ways. Table 6-1 summarizes available research on countries that have taken steps to reduce the use of plastic grocery bags.

**Table 6-1 Plastic Grocery Bag Global Policy Actions.**

Country	Action Taken	Results	Notes
Australia	Adopted a voluntary Code of Practice for the Management of Plastic Bags (2003)	Estimate usage reduced by 45% by 2006, followed by an 14% increase in usage in 2007	
	State of Victoria imposed ban (2009)	90% of shoppers now using reusable bags (compared to 60% prior to ban)	

Country	Action Taken	Results	Notes
Bangladesh	Imposed ban (2006) – in capital city only	Reemergence of an environmentally sustainable jute bag industry	Discovered plastic bags were responsible for clogging drainage systems that resulted in major floods
Belgium	Imposed levy (2007)	None reported	
Canada	Initiative to reduce consumption by 50% (2007)	None reported	
China	Considering conducting a feasibility study (2005)	None reported	Calls plastic bags their “white pollution”
Denmark	Imposed levy (1994)	Estimated initial reduced consumption of both paper and plastic bags by 60% with slight increase over time	
Hong Kong	Public Awareness Campaign (2003) themed “No Plastic Bag, Please” Environmental Protection Department urges imposition of a levy (2007)	Largely ineffective  None reported	
India	Imposed ban on thinner bags in major cities (2003)	None reported	Major issues with clogging of sewage drain systems and subsequent flooding



Country	Action Taken	Results	Notes
Ireland	Imposed "PlasTax" levy (2002) Increased levy by 50% (2007)	94% reduction in a few weeks Leveled off to 75% over time	
Kenya	Imposed levy (2005) Partial ban on thinner bags (2007)	Largely unsuccessful None reported	Base of a large plastic manufacturing industry (producing over 48 million bags per year)
New Zealand	Public awareness campaign (2005) themed "Reduce Your Rubbish"	None reported	
Scotland	Public awareness campaign (2003) themed "Fantastic, It is Not Plastic"	None reported	Also considered a tax (2003) Tax option abandoned entirely (2006)
South Africa	Imposed levy (n.d.) Improved recovery and recycling programs	Substantial reduction in usage	Dubbed the "national flower" because they were turning up everywhere as litter
Switzerland	Required supermarkets to charge for bags (2003)	None reported	
Taiwan	Levy (2003) Levy later lifted with respect to storefront restaurants	Estimated 68% reduction in usage, but observed increase in other plastic usage (e.g., takeout food containers) and experienced compliance/enforcement issues	Survey by Taiwan EPA revealed that 45% would continue not to use the bags even after the lift of the ban

Country	Action Taken	Results	Notes
Tanzania	Ban (2006)	None reported	
Uganda	Partial ban on thinner bags (2007)	None reported	
United Kingdom	Encouraged voluntary retail participation through special offers themed "Bag for Life" and "Penny Back" (n.d.)  Public awareness campaign inspired by Hindmarch's "I'm Not a Plastic Bag" designer tote (n.d.)	None reported  Hindmarch's tote bag made carrying a reusable bag "environmentally trendy"	Localized efforts have proved successful, but are minimal
U.S.	Encouraged localized efforts throughout the nation (2003)	Numerous cities have implemented or plan to implement bans or levies	Many large retailers voluntarily stopped offering plastic bags or are charging for them
California	Plastic grocery bag bans have been enacted in 87 cities and/or counties in California over the past decade.	None reported	

SOURCES: AECOM, 2010; EARTH DAY NETWORK, 2009; FOOD MARKETING INSTITUTE, 2008; ROMANOW, 2012.

This summary reveals that bans appear to have a longer-lasting impact, in terms of reducing plastic grocery bag usage, than levies. Levies do work, but they generally require incremental increases over time to ensure their continued effectiveness.

A detailed economic analysis was recently conducted for Los Angeles County to examine the economic impacts of enacting a ban on single-use plastic grocery bags and an associated levy on disposable paper bags in all unincorporated areas (AECOM, 2010). The consultants concluded that a ban (or levy)

would have negligible economic impact on either consumers or retailers (AECOM, 2010). This analysis did not include an assessment of the environmental benefits associated with the proposed policy action. The study also found that no disparate impact would fall on consumers living at or below poverty level.

The City of San Jose enacted a plastic grocery bag ban in 2012 (CalRecycle, n.d.). They subsequently contracted for a study to assess its effectiveness. The consultants reported

a significant reduction in plastic bag trash: an 89% reduction of plastic film in storm drains, 60% reduction on city streets, and a 59% reduction in local creeks and streams (Romanow, 2012).

To date, plastic grocery bag bans have been enacted in 100 municipalities throughout California (CalRecycle, n.d.). Table 6-2 details the municipalities located in or near the LA and SG River Watersheds that have enacted plastic grocery bag bans.

**Table 6-2 Plastic Bag Bans Enacted in or near the LA and SG River Watersheds.**

Municipality	Plastic Bag Ban	Enactment Date
Calabasas	Ban (10¢ charge for paper bags)	02/2011
County of Los Angeles	Ban (10¢ charge for paper bags)	11/2010
Culver City	Ban (10¢ charge for paper bags)	05/2013
Glendale	Ban (10¢ charge for paper bags)	01/2013
Huntington Beach	Ban (10¢ charge for paper bags)	04/2013
Laguna Beach	Ban	02/2012
Long Beach	Ban (10¢ charge for paper bags)	05/2011
Los Angeles	Ban (10¢ charge for paper bags)	06/2013
Malibu	Ban	05/2008
Manhattan Beach	Ban	07/2008
Pasadena	Ban (10¢ charge for paper bags)	11/2011
Santa Monica	Ban (10¢ charge for paper bags)	01/2011
West Hollywood	Ban (10¢ charge for paper bags)	08/2012

SOURCE: CALRECYCLE, N.D.

While these bans are a step in the right direction, the results would be far more effective if such an ordinance was passed

for all municipalities in the LA and SG River Watersheds (and a statewide ban would be even better).

### POLYSTYRENE BAN

Polystyrene (e.g., Styrofoam™) bans have been implemented in more than 30 cities in California over the past two decades; joining well over 100 other cities in the U.S. Table 6-3

details the municipalities located in or near the LA and SG River Watersheds that have enacted polystyrene bans.

*Table 6-3 Polystyrene Bans Enacted in or near the LA and SG River Watersheds.*

Municipality	Polystyrene Ban	Enactment Date
Calabasas	Takeout food packaging	2008
County of Los Angeles	Government facilities	2008
Hermosa Beach	Container ban	2012
Huntington Beach	Government facilities	2005
Laguna Beach	Takeout food packaging; retail sale of disposable foodware	2008
Laguna Hills	Government facilities	2008
Los Angeles	Government facilities	2008
Malibu	Complete ban	2005
Manhattan Beach	Food packaging ban	2013
Newport Beach	Complete ban	2008
Orange County	Government facilities	2005/2006
San Clemente	Complete ban	2011
West Hollywood	Restaurants and food vendors	1990

SOURCE: CALRECYCLE, N.D.

---

San Jose authorized a study released in 2012 to examine the economic impacts of a ban on polystyrene, citing concerns that this lightweight, buoyant material is easily broken down into small pieces, and poses a significant threat to the environment, as

well as the cleanup costs associated with this common litter item (Romanow, 2012). The researchers found that polystyrene constituted 7.8% of the total trash collected in their stormwater system.



*Figure 6-2 Polystyrene cups collect in a storm drain that opens to the San Gabriel River. Photo: Michael Mori.*

The report also states that suitable substitutes to polystyrene are currently available. They examined the end-of-life of three packaging alternatives: rigid plastic, compostable paper, and compostable plastic. Rigid plastic can be recycled but not composted. The researchers concluded that any of the three would be a better environmental alternative to polystyrene, which cannot be easily recycled or composted (Romanow, 2012). They recommended that a ban on polystyrene allow restaurants (the primary users of polystyrene products in the form of takeout containers) sufficient time to use up their current supply, identify sources for substitute materials, and conduct pricing research.

Polystyrene is not just used in takeout containers. The material is favored for many food-packaging uses, as well as the popcorn-shaped (“peanuts”) pieces used to protect package contents during shipping. A ban would be most effective if it also prohibited polystyrene for these purposes. Suitable substitutes for food-packaging would be the same as those referenced above for takeout containers. Popcorn used in shipping containers also has suitable substitutes, but care should be taken to ensure that air-filled plastic film bags are not identified as a suitable substitute, as this would just trade one plastic-related problem for another.



---

## 6.1.3 IMPLEMENT A COMPREHENSIVE SAN GABRIEL RIVER WATERSHED TRASH TMDL

---

### Recommended Actions:

- **Implement a San Gabriel River Watershed Trash TMDL that covers the entire watershed and addresses <5 mm plastic debris**
- **Better implementation in open land uses**
- **Incorporate mandatory monitoring even if in compliance**

The Trash Total Maximum Daily Loads (TMDLs) in the San Gabriel River Watershed (SG River Watershed), the East Fork San Gabriel River (East Fork) and Legg Lake, are lacking in effectiveness and cover a very small area of the watershed. For much of the SG River Watershed, plastic debris can flow primarily uninhibited from its source through to the ocean. Though this region has a lower population density than the LA River Watershed, there is still considerable concern about the amount of trash that is reaching its waterways. Similarities to the LA River Watershed and observed trash throughout the SG River Watershed, as discussed in the “Zero Trash TMDLs are Hit or Miss” Findings

section, make the entire watershed a candidate for a Trash TMDL.

We propose a comprehensive Zero Trash Total Maximum Daily Load in the SG River Watershed to reduce plastic debris in the area. A SG River Watershed Trash TMDL should adopt similar language to the LA River Watershed Trash TMDL, as we believe this TMDL has significantly reduced large plastic debris within its watershed. The implementation of a comprehensive Trash TMDL would not only help to prevent trash throughout the watershed from entering the waterways, but would also reinforce the East Fork and Legg Lake Trash TMDLs that have proven ineffective.



Polystyrene cup on the banks of the San Gabriel River  
Photo: Michael Mori

---

The SG River Watershed Trash TMDL should also be designed to improve on some of the LA River Watershed Trash TMDL's shortcomings (we also propose these shortcomings be addressed in the "Amend the LA River Watershed Trash TMDL" Action Item section). First, the SG River Watershed Trash TMDL should be more focused on open land uses. Based upon the ineffectiveness of the East Fork and Legg Lake Trash TMDLs and the high trash counts collected in these areas, a better approach should be brought to implementing the TMDL in open land uses. Similar to the LA River Watershed, much of the open areas in the SG River Watershed do not have a storm drain system. Therefore, catch basin inserts are not an effective trash reduction strategy. Narrowing down on the best method to reduce trash in these open areas is beyond the scope of this report, but increased litter law enforcement, additional trash receptacles, and more frequent receptacle pickups would likely have a positive effect.

Second, the SG River Watershed Trash TMDL should also include provisions dealing with smaller than 5 mm plastic debris. The LA River Watershed Trash TMDL allows for compliance with installation of full capture systems that have a 5 mm mesh, which means that the municipalities are not capturing many of the small pieces of plastic. Despite missing these small pieces, they are still allowed to be in full compliance with the zero trash limit of the TMDL. Smaller pieces of plastic can

have harmful effects on biotic food webs and ecosystem processes and should be controlled through our proposed SG River Watershed Trash TMDL. Since these small pieces often come from larger plastics which have broken down, controlling littering through greater enforcement and single-use plastic bans would also have a significant impact on the reduction of small plastic debris.

The exact regulatory mechanisms to achieve this are beyond the scope of this project, although it will likely require incentives as a TMDL would not have the direct enforcement power to require cities to ban certain products or increase resources to litter law enforcement. Additionally, implementing a plastic pellet monitoring program similar to the Santa Monica Bay Nearshore Debris TMDL would help to bring attention and metrics to preproduction plastic materials, which are typically smaller than 5 mm.

Third, in the LA River Watershed Trash TMDL cities do not have to monitor their trash levels if they have installed full capture systems. However, since full capture systems do not capture all trash, these cities are probably still emitting trash to the waterways. Our final recommendations for the SG River Watershed Trash TMDL include the implementation of mandatory monitoring for all cities in the TMDL, even if they are in compliance with a full capture system.

---

## 6.1.4 REDUCE SINGLE-USE PLASTIC

---

### Recommended Actions:

- **Increase use of reusable containers**
- **Implement point-of-sale fees**
- **Increase items covered under California Redemption Value (CRV) program**

Plastics were once used as a replacement product for more expensive and often rare natural items, such as ivory and earth metals. Today plastics are used for throwaway items such as single-use packaging and takeout food containers. These single-use plastic items are easily littered and frequently appeared in the

trash collection studies examined within the LA and SG River Watersheds, as discussed in the “Assessing the Quantity of Plastic Debris in the Watersheds” Findings section. In the following section, we discuss three ways to reduce single-use plastic: large-scale adoption of reusable containers, point-of-sale fees, and increasing CRV programs.

### REUSABLE CONTAINERS

---

While recyclable and compostable plastic containers have reduced the amount of trash in landfills, single-use containers are still one of the most commonly found littered items along the LA and SG River Watersheds. Single-use containers are becoming

more common with growing populations, exacerbating the problem of plastic litter. We recommend that businesses implement container exchange programs to reduce single-use plastic.

#### *Container Exchange and Reduction Programs*

Container exchange programs can ameliorate many single-use plastic litter problems and encourage a culture of reuse. We recommend that durable reusable container exchange programs be implemented in food settings with repeated customer use and takeout meals, such as school dining halls, office lunch courts, fast food restaurants, and event venues.

Container exchange programs are akin to bringing a reusable coffee mug to a coffee shop. In such a program, a reusable container (typically a hinged compartmentalized

container with a set of silverware) is purchased or leased for a small amount. This container can be used to collect takeout food items and brought back for reuse later. Some dining facilities may have the ability to take in the dirty containers and give the customer a clean container, while others may expect the customer to bring in a clean container ready for use. This type of program lends itself well to locations where there is repeated use with the same customer base. Ideal locations include dining halls that students visit daily, lunch rooms and restaurants within large business complexes, as well as event venues.

---

A financial incentive to return containers in the form of a payment upon return would incentivize people to participate. As another form of financial incentive, merchants could offer a discount on food and/or beverage purchases when the consumer brings in a reusable container. For example, Starbucks customers who bring their own mug receive a 10¢ discount.

Container exchange programs have been implemented across the U.S. and have been received with great success. Harvard University implemented one such program in the graduate student dorms. Shortly after implementation, approximately 75% of the students were using the reusable containers instead of disposable boxes, reducing container waste by nearly 75% (Stoll, 2013).

As occurred at Harvard, implementation of container exchange programs may have the added benefit of changing the cultural attitude towards reuse of plastic instead of single-use throw away items.

A different approach to single-use plastic reduction is to swap out a single-use item for a multi-use item. For example, some hotels have switched from providing small bottles of shampoo and lotion to bulk soap dispenser units. In addition to reducing plastic waste, this type of system change may also lead to reduced costs. For example, Inter-Continental Hotels greatly reduced their single-use plastics waste by switching to bulk soap dispensers in its ten North American properties and reported a savings of \$300,000 per year (Starkey, 1996).

### POINT-OF-SALE FEES

Placing a fee on the purchase of single-use plastic items would help reduce plastic debris by raising revenue to pay for proper disposal and cleanup of the item, funding anti-litter public educational programs, and discouraging purchase of the item due to the higher price. Similar to the system of taxes on cigarettes at the point-of-sale, this fee is an extra charge that consumers pay when purchasing the item.

The extra cost of the item associated with the point-of-sale fee may incentivize some consumers to choose another item, such as a product without a point-of-sale fee, or a reusable product where they will only be charged once rather than for multiple purchases. The revenue generated could be used to ensure proper disposal or cleanup

of the littered item, as well as funding for anti-litter educational programs that teach children the impacts of litter and plastic use. Litter education is further discussed in the "Litter Law Enforcement, Outreach and Education" Action Item section.

Based on the data analyses we performed, single-use plastic containers represent a significant portion of the plastic waste stream. Since the point-of-sale fee framework already exists for items like cigarettes, we believe it would be feasible to develop a similar program for single-use plastics. Items that could potentially be covered under this system include common litter items, such as plastic bottles, hard plastic containers (e.g., sealed around items such as batteries, beauty products, and electronics), items with



---

plastic wrap (e.g., pre-packaged vegetables), cigarettes, and single-use plastic food utensils. For example, when purchasing a takeout meal, if customers do not bring in their own reusable silverware they could be charged a fee of 5¢ or 10¢ for a single-use

option. Fees as low as 5 or 10 cents can be very effective at reducing product use. Reducing purchases of single-use plastic will reduce waste, and a culture of reuse will grow as people become more accustomed to the idea of reusable items.

### CALIFORNIA REDEMPTION VALUE (CRV) PROGRAM

Similar to the point-of-sale fees described above, a system in which a fee is placed on an item that can then be collected upon return has also been shown to be very effective at reducing waste and encouraging recycling. A worldwide study in 2006 showed that highest recycling rates occurred in countries with recycling incentives (Loughlin, 2006). In our study region, the California Beverage Container Recycling Program provides cash incentives for container recycling. The Department of Resources Recycling and Recovery, also known as CalRecycle, runs the California Beverage Container Recycling Program. Under this program, consumers pay the California Redemption Value (CRV) when they purchase beverages from a retailer. Containers covered in this program that are less than 24 ounces have a 5¢ CRV and containers 24 ounces or larger have a 10¢ CRV. These products can then be returned after use for reimbursement of the entire CRV fee. However, many plastic containers are not included in the current system, such as milk, wine, and distilled spirit containers (Table 6-4).

To identify whether or not an item qualifies as a CRV beverage container, a stamp can be found on the top of aluminum cans and an ink icon appears on plastic items (Figure 6-3). To our knowledge, California is the only state

in which CRV bottles can be turned in at more than 2,400 certified recycling centers or curbside programs. This program is more convenient than its counterparts in many other states that require the containers to be returned to the store from which they were purchased (CalRecycle, 2013).

While the overall recycling rate of plastic was less than 10%, in 2012, over 80% of all CRV containers were recycled, equating to more than 17.2 billion containers in California (CalRecycle, 2013). The proven success of this program makes the prospect of its expansion even more appealing.

To increase recycling rates, we recommend expansion of the CRV program to include additional items and research into whether increasing the monetary incentive is a feasible option. As listed above, there are a variety of plastic containers not yet accepted under the current CRV program. We recommend that CalRecycle expand their program to cover plastic containers such as milk jugs, wine bottles, spirits, and other common litter items.



**Table 6-4 Items covered under the California Redemption Value Program**

CRV Eligible Items	Not Eligible Items
• Beer and malt beverages	• Milk jugs
• Wine coolers and distilled spirit coolers	• Medical food
• Carbonated fruit drinks, water or soft drinks	• Infant formula
• Coffee and tea beverages	• Wine
• 100% fruit juice less than 46 oz.	• Spirits
• Vegetable juice 16 oz. or less	• 100% vegetable juice more than 16 oz.
• Sports drinks	• Food and other non-beverage containers

SOURCE: CALRECYCLE, N.D.



**Figure 6-3 Containers that are eligible for the California Redemption Value refund are stamped or labeled as so. (Photograph courtesy of CalRecycle, n.d)**

---

## 6.1.5 COLLECT BETTER BUSINESS LICENSE INFORMATION TO TRACK INDUSTRY

---

### Recommended Actions:

- **Gather industry information on facilities that handle preproduction materials through modified business license applications (and renewals)**
- **Compile a shared database between municipalities and regional water boards**

### BUSINESS LICENSE APPLICATION MODIFICATIONS

Conversations with regional water board personnel frequently revealed frustration with identifying industrial facilities that should be operating under an Industrial General Stormwater Permit (C. Boschen, personal communication, July 1, 2013; A. Fischer, Personal Communication, September 3, 2013; D. Seidner, personal communication, December 5, 2013). Countless hours of drive-bys, Google Maps searches, web searches for

business listings, and other similar efforts are expended regularly to identify these facilities. A simple, more coordinated approach is recommended. Each municipality and the county should amend their business license application forms to include a check box that identifies whether a facility handles preproduction plastic materials in resin, powder, or pellet form.

### DEVELOP COUNTY-WIDE INFORMATIONAL DATABASE

Information collected on business license applications (and renewals) should be digitized and entered into a countywide database. Municipalities should share the information they collect from their business license applications with regulating agencies, such as the regional water boards. Plastic facilities are reported to be somewhat transient (C. Boschen, personal communication, July 1, 2013; A. Fischer, Personal Communication, September 3, 2013; D. Seidner, personal communication,

December 5, 2013). This type of coordinated information is necessary to be able to track their movements.

A shared database should be compiled by the Regional Water Boards that make identification of plastic facilities simple, fast, and efficient. Reporting on violations should also be included in this regional database. In effect, a one-stop shop is needed to ensure that accurate and timely information is being shared by those charged with regulating this industry.

---

## 6.2 TIER 2 ACTION ITEMS

---

### 6.2.1 AMEND THE LA RIVER WATERSHED TRASH TMDL TO PLUG THE (TRASH) HOLES

---

#### Recommended Actions:

- **Amend the LA River Watershed Trash TMDL to address <5 mm trash, nonpoint sources, and develop a plastic pellet monitoring program**
- **The Los Angeles Regional Water Quality Control Board should provide easier access to compliance reports and enforcement actions on their website**

The Los Angeles River Watershed Trash TMDL (LA River Watershed Trash TMDL) is a pioneering trash reduction strategy with an objective of zero trash discharge. Cities in the watershed are estimated to be investing hundreds of millions of dollars from 2007 to 2016 to reduce their contribution of trash to the watershed (LARWQCB<sup>2</sup>, 2007). As demonstrated in our “Zero Trash TMDLs are Hit or Miss” Findings section, over 75% of cities are in compliance with the 70% trash reduction required by 2012.

However, even if all cities were in compliance with the Trash TMDL, certain types of nonpoint sources of trash would still enter the waterways, such as smaller than 5 mm trash, direct improper disposal from homeless encampments, and from people who are throwing trash directly into the river. The LA River Watershed Trash TMDL should be amended to better address these sources of trash. Possible amendments include the installation of better full capture systems capable of capturing smaller than 5 mm trash, incentives to encourage better litter law

enforcement, and monitoring of homeless encampments along the river.

A more recent Zero Trash TMDL established in the Los Angeles region, the Santa Monica Bay Nearshore Debris TMDL, has built on the foundation of the LA River Watershed Trash TMDL by adding plastic pellet monitoring and nonpoint source area BMPs and monitoring. We recommend amendment of the LA River Watershed Trash TMDL to include similar language.

Additionally, nearly 25% of cities under the LA River Watershed Trash TMDL were not in compliance in 2012. Enforcement methods and actions to determine who was in compliance were not publicly available, and compliance reports (which are part of the public domain) took quite a bit of effort to obtain. The LARWQCB should have all of these documents publicly available on their website, and enforcement methods and action should be more clearly stated for greater stakeholder and public engagement.

---

## SMALLER THAN 5 MM TRASH

---

The LA River Watershed Trash TMDL has made great strides in reducing greater than 5 mm trash before it reaches the waterways with the installation of thousands of catch basin inserts and other full capture systems. However, when the LARWQCB defined a full capture system as a device capable of capturing all greater than 5 mm trash (LARWQCB<sup>1</sup>, 2007), it allowed for pieces of trash that are less than 5 mm in size to pass through the catch basins and be deposited into the river. Therefore, cities are allowed to be in compliance with the Zero Trash TMDL while not actually capturing all trash. As demonstrated in the “The Impacts of Plastic Debris are Fairly Well Understood” Findings section, small pieces of plastic have multiple negative environmental impacts.

The main sources of smaller than 5 mm trash for the areas under the LA River Watershed Trash TMDL are larger pieces of trash that have broken down into smaller pieces. Certain types of plastic, such as polystyrene, are very susceptible to breakdown on land. A solution to reducing this type of trash would require multiple approaches: single-use polystyrene bans, increased litter law enforcement, and increased use of more efficient capture systems.

Banning polystyrene from use in takeout containers and other single-uses was discussed earlier in the “Bans Are Necessary” Action Item. Given that previous studies have shown polystyrene to be the most common small piece of plastic by count (Moore et al., 2011), and that multiple cities in California have already banned single-use polystyrene, amending the LA River Watershed Trash

TMDL to encourage this type of reduction via citywide bans is both politically feasible and would reduce the amount of smaller than 5 mm trash that enters the LA River Watershed. However, the TMDL would not have the power to require cities to ban these products, but creativity with incentives could be a driving force for these bans. At the very least, putting more emphasis in the TMDL on this subject will help bring awareness to the issue.

For other sources of plastic that break down into smaller than 5 mm trash, or for uses of polystyrene other than single-use containers that become litter, increased enforcement of litter laws is recommended as reducing these sources of plastic would help to reduce small plastic pieces that are difficult to capture. In the “People Litter – A Lot!” Findings section, it has been shown that police in the area do not consider litter law enforcement a high priority. Putting an emphasis on litter law enforcement would help to prevent people from littering with the threat of a ticket hanging over their head. Although this BMP is mentioned in the LA River Watershed Trash TMDL as a method of TMDL compliance, it does not seem to be a priority for the cities. In the same vein as banning polystyrene, it is unlikely a TMDL would have actual enforcement power to require cities to increase their litter law enforcement, but creativity with incentives could provide the impetus for cities to allocate additional resources to this area. Litter law enforcement is discussed further in the “Litter Law Enforcement, Outreach and Education” Action Item section.

Another option, although potentially economically or technically less feasible, would be a greater investment in full capture systems that can capture smaller than 5 mm trash, such as commercially available CDS units (Figure 6-4). These devices are LARWQCB-approved full capture systems that have been shown to collect 100% of 0.425 to 0.600 mm and larger particles of sediment from entering the waterways (Schwarz and Wells, 1999). This is in contrast to the much more common catch basin inserts in current use, which are only capable of capturing 80%-90% of > 5 mm size trash in a rain event that is greater than 0.25 inches (City of LA, 2006). Additionally, much of the 10%-20% that is not captured is lightweight plastics such as polystyrene (City of LA, 2006). CDS units have already been installed in some areas of the watershed, such as high-trash generation areas of Los Angeles (City of LA, n.d.).

A mandate for the installation of more CDS units would reduce plastic debris that is smaller than 5 mm. We acknowledge some of the issues with CDS units that may have prevented higher implementation rates; specifically, that they can cause hydrologic issues upstream and increase flooding, and their cost is much greater than more typical full capture systems such as catch basin inserts (City of LA, 2002). The

LA River Watershed Trash TMDL document estimated the upfront capital costs for a catch basin insert at \$800, while a CDS unit can cost tens of thousands to hundreds of thousands of dollars per unit, depending on the amount of flow it can handle (Kharaghani, 2003). These CDS units are not installed per catch basin, but can be found downstream of multiple catch basins. Although the monetary and hydrologic issues may prevent further installations of CDS units, efforts should be focused on improving full capture systems beyond the current ones that are not capable of stopping smaller than 5 mm trash from entering the waterways.

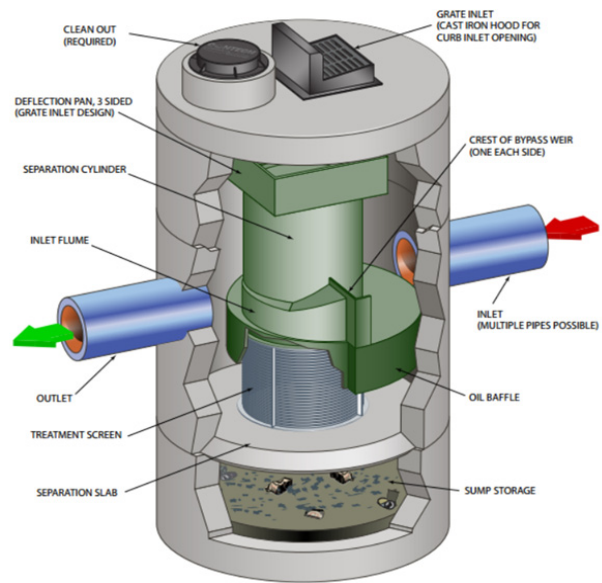

*Figure 6-4 A CDS unit schematic. (Photograph Courtesy of CDS Technologies)*

## DIRECT IMPROPER DISPOSAL

Trash that is directly dumped into the waterways is not addressed in the LA River Watershed Trash TMDL given the emphasis with BMPs on land (e.g., catch basin inserts and increased street sweeping). Although

the data on the contribution of direct improper disposal to the overall quantity of plastic debris is scarce, the amount of trash contributed by homeless encampments next to the river, people discarding trash directly



---

into the river, or litter that gets blown into the river appears to be significant from site visits and interviews.

The proportion of trash directly dumped into the river compared to trash on land is expected to increase as structural and institutional BMPs in the LA River Watershed Trash TMDL focus on reducing the land portion. Therefore, it is anticipated that direct improper disposal will become a growing issue moving forward, and reducing plastic debris from homeless encampments and direct littering will become an issue of greater importance in meeting the

zero trash goal of the LA River Watershed Trash TMDL. Reducing plastic debris from homeless encampments is a complex issue, as it is a social problem that goes beyond the typical jurisdiction of water quality agencies. Better data collection and stakeholder collaboration would provide the motivation for greater acknowledgement of the problem. Amendments to the LA River Watershed Trash TMDL could require mapping of and trash collection in homeless encampments. Reducing the contribution from direct trash dumpers is a less complex issue, as increases in litter law enforcement discussed above would help to reduce this plastic debris.

### SANTA MONICA BAY NEARSHORE DEBRIS TMDL ADDITIONS

We recommend that the LA River Watershed Trash TMDL be amended to require plastic pellet monitoring by the municipalities and include coverage of nonpoint source areas, similar to the Santa Monica Nearshore Debris TMDL that was discussed earlier in the “Zero Trash TMDLs are Hit or Miss” Findings section. There is currently a dearth of data on the amount of plastic pellets entering the waterways; significant evidence has been found of pellets on beaches and in the marine environment, but only one such study exists for the LA River (Moore et al., 2011). The data collected from such a monitoring

program would help establish the amount of pellets entering the waterways. A monitoring program is cost effective, as the Santa Monica Bay Nearshore Debris TMDL document estimates the annual cost of monitoring plastic pellets at \$300 per storm drain (LARWQCB, 2010).

The requirement of zero trash in nonpoint source areas would encourage more emphasis on recreational areas that our findings have demonstrated have a high amount of trash, despite the current Trash TMDL. The extra monitoring required for nonpoint source areas would place a focus on problem areas.

### EASILY ACCESSIBLE COMPLIANCE AND ENFORCEMENT INFORMATION

As part of the LA River Watershed Trash TMDL, the cities must submit an annual compliance report to the LARWQCB that states if they are in compliance through installation of full capture systems, monitoring, or other means. These reports are

public documents and the 2012 reports are analyzed in the “Zero Trash TMDLs are Hit or Miss” Findings section. However, they are not accessible on the LARWQCB’s website and were only made available to us after going through multiple LARWQCB employees,

---

sending multiple e-mails, and making numerous phone calls. While LARWQCB staff were friendly and amenable to the requests, it nonetheless took considerable effort to access these public documents to determine whether cities were in compliance with the LA River Watershed Trash TMDL.

Additionally, it was difficult to gather information on possible enforcement actions against cities not in compliance. The official LA River Watershed Trash TMDL document from 2007 states that “exceedance of the allowable discharges will subject the permittee to enforcement action.” The type or extent of enforcement action is unknown

and this information was claimed to be confidential.

It is recommend that the LARWQCB have a dedicated section on its website that posts the LA River Watershed Trash TMDL compliance reports, the details on the decision-making process as to who is in compliance and who is not in compliance, and the enforcement actions brought against municipalities that are found to be in non-compliance. The accessibility of the Trash TMDL compliance information would increase public awareness and stakeholder participation.

## 6.2.2 COLLECT BETTER DATA NOW

---

### Recommended Actions:

- **Fill data gaps**
- **Include sizes of debris**
- **Identify sources of debris**
- **Monitor microplastics in WWTP effluent**
- **Quantify and characterize homeless contribution**
- **Improve methods of data collection through standardization**

Through our analysis of plastic debris in the LA and SG River Watersheds, we have found significant data gaps that hinder detailed analysis of plastic debris quantity and characterization. More informed analyses, which can better inform policy

recommendations, would be possible by filling in the most significant data gaps: sizes, wastewater treatment plants, homeless encampments, and consistent data collection and reporting methodologies.

### SIZE

---

The size of a piece of plastic has implications to biotic consumption and toxin sorption and should be documented. We feel that this is one of the more important data gaps we encountered and the issue can be easily remedied. The inclusion of size categories

on datasheets or even the use of reference photographs would help to determine the relative sizes of plastic debris (Figure 6-5). Even denoting the maximum and minimum sizes of plastic debris that is collected would be useful information.



*Figure 6-5 Sample reference photographs can help identify the sizes of debris based on visual cues like grids. The red pellet is about 5 mm long. Photo: Michael Mori*

This type of measurement has particular value in the LA River Watershed because the current Zero Trash TMDL defines trash as being what can be trapped with a 5 mm mesh (i.e., larger than 5 mm trash). Identifying the

sizes of plastic debris within the watershed would help to assess the effectiveness of BMPs and full capture systems at preventing plastic from getting into the waterways.

### SOURCE IDENTIFICATION

Identifying the sources of plastic debris would also be a valuable tool in reducing the quantity that enters the environment. While the identification of plastic debris is currently done in part by trash collection studies, they only record the use of the plastic item. For example, if it is a polystyrene cup, it will be documented as a cup. While this is beneficial, going one step further would better inform

future analyses. Identifying the source of the plastic by noting the brand or company that distributed the item can streamline the process of source recognition and reduction. For example, if there are plastic cups in a river from a specific restaurant chain, a reduction strategy could be implemented to place more trash receptacles near that facility.

### WASTEWATER TREATMENT PLANTS

An emerging topic in plastic debris is the presence of microplastics in wastewater treatment plant discharge. Microplastics originating from clothing fibers and cosmetic products are making their way

into wastewater treatment facilities and their fate is largely unknown. While local wastewater treatment plant personnel did not believe microplastics to be of concern in their discharge, some preliminary research

---

has found that microplastic debris is actually present in wastewater discharge (5 Gyres Institute, 2013; Kinver, 2012).

Whether these tiny plastics end up in biosolids produced by the plant (and potentially placed on agricultural fields through applied biosolids) or discharged into the effluent (and eventually to the ocean) is not well known. Quantifying the amount of these plastics that are entering wastewater treatment plants and what their eventual fate is needed to inform wastewater treatment plant policy.

Despite current deficiencies in data on this topic, the concern over microbeads has garnered national attention. In 2014, lawmakers in Albany, New York worked with the 5 Gyres organization to propose a ban on the sale of cosmetic products with plastic microbeads (New York Times, 2014, Feb 10). Days later, a similar ban was proposed in Los Angeles with the help of 5 Gyres (Los Angeles Times, 2014, Feb 13). With the inclusion of stronger data to support actions like these, the case against microplastics could result in stronger legislation.

### HOMELESS ENCAMPMENTS

---

Information pertaining to homeless encampments as a source of litter into the river is rare or incomplete. Most of the data collected on this topic come from homeless eviction operations where homeless men and women are removed from an area and the debris left behind is collected and thrown away. While rough estimates are made by the ton, it would be beneficial to take a more in-depth look at the composition of

plastic debris originating from homeless encampments. As a potentially major source of larger debris that ends up in the LA and SG Rivers, it would be useful to have more information on homeless encampments, such as the number and location of encampments, the number of residents, a breakdown of the trash they contribute to the environment, and characterizations of the trash.

### IMPROVING DATA COLLECTION

---

The acquisition and application of sound data helps to inform policy decisions. Much of the plastic debris data are collected in such a manner that makes it difficult to combine the findings of different agencies and organizations, and gaps in information make it difficult to identify potential solutions to these problems.

Studies that are conducted on a local or regional level often do not share concurrent goals and thus tend to hone in and collect data for specific purposes, while a broader spectrum of data would be beneficial, not

only for future use on a local level, but at a larger scale (Table 6-5). There should be a more standardized method of plastic data collection that would serve to inform a larger collective. The datasets analyzed in this report often collected different types of data depending on the design of the research being done, but few had GPS data easily available or any information depicting the size of the debris. While the most comprehensive of these datasets were done by the City of LA and at Herondo Drain, combining different aspects from different studies would be the most beneficial.

**Table 6-5 Summary of the types of information provided by different studies.**

Dataset	GPS	Site Description	Count	Weight	Volume	Size	Plastic Type
Bight '13 Study		X	X				X
City of Los Angeles Bureau of Sanitation Dataset			X	X	X		X
TMDL Monitoring							
Fullerton Creek Study			X				X
Furman							
Herondo Drain Study		X	X	X			X
Teach and Test Program							
Heal the Bay Beach Cleanup	X		X			X	X

The following are recommendations for standardized methods of data collection and topics that should be investigated further, as they are deemed crucial for a better understanding of source, transport, and fate of plastic debris.

The analysis of the flow and quantity of plastic debris in the LA and SG River Watersheds is a topic that has implications broader than the scope of this project. Recommendations to remedy the issue of plastic pollution would have a more solid foundation if more and better data were available. Continuity between trash collection studies and across multiple agencies and organizations, would lead to comprehensive datasets that could be thoroughly analyzed temporally and spatially.

Given the diverse nature of studies, it is understandable why different parameters have been used in studies. However, some overarching themes should be present throughout all studies. The fundamental aspects of assessing plastic debris in waterways should include the site characterization, collection parameters, and data processing. Building off current resources, utilizing the Rapid Trash Assessment tool used in the Bight '13 study is a good outline for data collection. Additional information that should be added to the Rapid Trash Assessment report includes weight and volume (City of LA) and GPS coordinates (Heal the Bay). Additionally, the inclusion of specified size categories have not been addressed by previous studies and



---

should be added to future data collections. Wherever feasible, the source (manufacturer or brand owner) of the trash should be

identified. A comprehensive trash collection study would include the following:

#### **Site Characterization:**

- GPS coordinates
- Pre-determined study area (e.g., 10 ft. on either side of stream for a 50 ft. stretch)
- Watershed, County, City, Stream Name
- Contributing land use
- Relevant features within a defined distance (e.g., homeless encampments or outfalls)

#### **Collection Parameters:**

- Size of the plastic (e.g., using a relative size tool or defined size categories)
- Number of pieces of plastic
- Weight of the plastic
- Volume of the plastic
- Standardized categories (e.g., by SPI code, type, polymer and use)
- Source identification (e.g., noting specific brand or manufacturer names where available)

#### **Databases:**

- Uploaded to a centralized database that is shared and available to other interested parties
- Format data in a standard way

---

## 6.2.3 PRODUCER RESPONSIBILITY SHOULD BE EXTENDED

---

### Recommended Action:

- **Plastic producers must pay fees in order to aid in the proper disposal and cleanup for their product's end of life**

In order to reduce plastic litter, the environmental cost burden may also be placed on the producer through extended producer responsibility (EPR) programs. EPR is “the extension of the responsibility of the producers, and all entities involved in the product chain to reduce the cradle-to-cradle impacts of a product and its packaging; the primary responsibility lies with the producer, or brand owner, who makes design and marketing decisions” (CalRecycle, n.d). The EPR strategy is based on the concept that manufacturers or brand owners have the most control over product design and therefore have the most control over the end-of-life options for an item. EPR is commonly seen in three main forms: design intended for reuse, design intended for recycling, or required product buy-back. The EPR strategy is aimed at integrating environmental costs throughout the life cycle of a product.

EPR practices started in the 1970s and 1980s with the implementation of “bottle bills.” These bills require beverage companies (or a third party company they hire) to take-back and recycle their empty throwaway bottles and cans (Product Policy Institute, n.d). These programs have been expanded in some locations to include take-back of hazardous materials such as paint, pesticides, motor oil, computers, and televisions. Statewide EPR framework legislation has been introduced in California, Minnesota, Oregon, Washington, Maine, Vermont, Rhode Island, and New York.

As of 2010, Maine was the first state to pass such a bill (Product Policy Institute, n.d).

An example of a successful take-back program that could be used as a template for plastic-related take-backs comes from Sony Electronics. In 1996, Sony began taking responsibility for properly disposing of their end-of-life products (Smith, 2008). They added e-waste drop off centers within 20 miles of their company stores throughout the U.S. To incentivize consumers to participate in their take-back program, they offered a television trade-in for a \$100 discount off their next purchase (Smith, 2008). Due to the monetary incentive for consumers to participate, it is likely that the return of old electronics has reduced electronic waste that contributes to the litter problem.

Based on our data findings that single-use plastics and bottles are a common form of litter along rivers, we recommend increasing incentives to reduce single-use plastic production. We recommend requiring manufacturers and brand owners to participate in Extended Producer Responsibility programs. Due to the monetary costs associated with holding producers responsible for collecting used plastics, they will be incentivized to change product designs towards more easily recoverable or reusable materials. By making products that are multi-use, the waste stream associated with plastics will decrease.

---

## 6.2.4 INCREASE RECYCLING RATES

---

### Recommended Actions:

- **Develop standardized symbol for recyclable and compostable materials.**
- **Change material type so more recyclables are produced**
- **Increase the amount of recycling containers available on the streets and in buildings in LA**

The current system of recycling identification, called the Universal Recycling Symbol, is used on plastic products to symbolize the type of resin used to make the product (EPA<sup>2</sup>, 2013) (Figure 6-6). While these arrows appear on most plastics, they are generally not present on films, shipping materials, or clear plastic packaging. The numbers one to six represent the polymer type. Contrary to public understanding, not all items with this label are recyclable.



*Figure 6-6 Universal Recycling Symbol  
(Photograph courtesy of Wikipedia, n.d)*

One estimate shows that the recycling rates for plastic within the U.S. are as low as 8.3%. Of the 31.8 million tons generated, only 2.7 million tons are recycled (EPA<sup>2</sup>, 2013). Contributing to this low rate is the fact that some resins are easier to recycle than others (Table 6-6). For example, thin materials such as films and puffed plastics are not accepted at all recycling facilities, and even if they are accepted, cleaning them to the level necessary for reuse can be time- and energy-intensive.

Low recycling rates may be due to a host of reasons: lack of motivation to recycle, uncertainty as to what is recyclable, inadequate economic incentives, and a shortage of recycling infrastructure. In the following section, we discuss how some of these issues may be addressed by making recycling easier, creating a universal labeling system, and increasing the production of plastic materials that can be recycled (especially those that are included in the CRV program).

*Table 6-6 Recycling rates by material type in 2012*

Material	Recycling Rate
HDPE	91%
PET	70%
PS	18%
PVC	5%
PP	5%
OTHER	5%
LDPE	1%

*Derived from Report of Beverage Container Sales, Returns, Redemptions, and Recycling Rates.*

*Source: CalRecycle, 2013*

---

## PLASTIC LABELING

---

A major step in increasing recycling is deepening consumers' understanding of recycling. Consumers should be able to easily determine if the items they are purchasing are recyclable or not. The current system can be misleading because not all plastics with the chasing arrows are recyclable. To alleviate this lack of recyclable transparency, we recommend that a standardized symbol for recyclable materials be developed.

Awareness is a prerequisite to behavioral change. By making the recyclability

of products easier for consumers to understand, they are given the tools to then make appropriate purchases and disposal decisions. Additionally, people can become more conscious of the materials they are purchasing, perhaps prompting changes in consumer behavior to using more recyclable materials. By creating a standardized system, decision making is easier and thus more likely to occur; over time these decisions can become habit. Hopefully, if people become accustomed to putting their waste in recycling bins, they are less likely to litter.

## SWITCHING TO RECYCLABLE PLASTICS

---

Based on our findings of plastic composition, single-use plastics such as wrappers and polystyrene are among the most commonly found littered plastics in the LA and SG River Watersheds. These products are often made from non-recyclable plastics, or their recyclability may not be clearly labeled. We recommend reducing non-recyclable plastic production by switching to recyclable plastic materials, such as polyethylene, the plastic with the highest recycling and recovery rates.

In conjunction with a better labeling system, increasing the number of products that are recyclable will encourage increased recycling. The less time people have to spend trying to figure out how to dispose of an item, the less likely they are to improperly dispose of it. Due to the potential for other environmental impacts associated with increased production of certain types of plastics, however, we recommend additional research to determine if resin switching is a feasible option.

## RECYCLING BIN AVAILABILITY

---

Curbside pickup, where trash collectors come to residences to collect waste and recycling, exists throughout the U.S. These programs can be very successful at preventing litter. In an interview with NPR, Ron Goen, New York's Deputy Commissioner for Recycling and Sustainability, said that he believes recycling is habit-forming; people identify with the messages they receive from seeing recycling containers in public places and begin to practice recycling in their homes. In

fact, studies have shown that his intuition is correct. In more than 80% of respondents to a survey, people admitted that they had first become aware of recycling by seeing recycling bins on the street (McDonald et al., 1997; Belton, et al, 1994). Additionally, studies have shown that more frequent pick up of recycling containers is correlated with higher recycling rates (Noehammer et al., 1997<sup>a</sup>; Everett et al., 1993).

---

Providing people with the option of proper disposal is a prerequisite to preventing improper disposal. We recommend that more recycling receptacles be installed in public locations, creating visual awareness

and giving people the option of recycling. As recycling bins become more common people have a place to put there discarded waste and as the culture of using recycling bins expands, we expect to see a decrease in plastic litter.

## 6.2.5 OPERATION CLEAN SWEEP IMPROVEMENTS

---

### Recommended Actions:

- **Policies to increase OCS participation rates**
- **Increase educational outreach efforts**
- **Establish solid metrics to measure success and penalize repeat offenders**
- **Industry needs to develop source-reduction strategies (take-back programs)**

Operation Clean Sweep (OCS) is the plastic industry's voluntary program to encourage plastic facilities that handle preproduction plastic materials in resin, powder, or pellet form to engage in effective Best Management Practices (BMPs). Participation is low,

especially in the Los Angeles and San Gabriel River Watersheds. The voluntary OCS program has been around for more than 20 years but the low adoption rates demonstrate that the problem is not being fully addressed.

### ESTABLISH INCENTIVES FOR PARTICIPATION

---

Efforts should be stepped up to ensure significantly higher adoption rates by facilities in the region. Incentives should be established to reward participants. This may best be accomplished through outside pressure from major retailers and other purchasers of plastic products. Major retailers should be encouraged to establish vendor

responsibility programs that ensure they are only purchasing plastic products from suppliers that participate in OCS. Regional Water Boards may want to consider offering a discount on Industrial General Stormwater Permit fees for facilities that are OCS members in good standing.

### ESTABLISH GUIDELINES TO QUALIFY AS AN OCS PARTICIPANT

---

Simply signing a pledge and getting a sticker does not ensure compliance. Major and/or repeat violators of the regulations (or a lack of BMP implementation) under the Industrial General Stormwater Permit should not be allowed to participate in OCS unless and until they remedy their mishandling of preproduction plastic pellets.

Follow-up and follow-through are needed to ensure that the program is working. A set of metrics needs to be developed to measure the effectiveness of successful adoption of BMPs. Without such metrics and high participation rates, OCS will not be effective at reducing preproduction plastic debris.



---

## EDUCATION AND OUTREACH

---

The plastics industry should sponsor education and outreach campaigns to ensure that processing facilities are fully aware of the negative impacts of preproduction

plastic pellets when they are released into the environment and the ease with which many BMPs can be implemented.

## SOURCE REDUCTION STRATEGIES

---

OCS does not currently address the broader need for industry to develop source reduction strategies for common litter items – such as single-use plastic packaging, plastic grocery bags, and cigarette butts. The industry may need to be forced (by regulatory action) to take the issue of plastic debris more seriously

and become part of the solution, rather than part of the problem. Suggestions for take-back programs are discussed in the “Producer Responsibility Should be Extended” and “Packaging Innovations Need to be Incentivized” Action Items sections.

## 6.3 TIER 3 ACTION ITEMS

---

### 6.3.1 PACKAGING INNOVATIONS NEED TO BE INCENTIVIZED

---

#### Recommended Actions:

- **Establish supply chain efficiencies**
- **Incentivize innovative packaging design**
- **Switch out to suitable substitutes**

## SUPPLY CHAIN EFFICIENCIES AND INNOVATIVE DESIGN

---

Using only reusable containers for food and drink is an ideal goal, but one that will take time to make the necessary cultural and industrial supply changes. Phasing out single-use plastics will occur over time from a change in consumer behavior (and thus consumer demand) and from the implementation of more stringent industry-based plastic reduction programs. In recognition of the lengthy timescale required for the completion of both of these goals, immediate reduction practices are also recommended.

Reducing the amount of raw material used in recyclable plastic products reduces the overall weight of plastic materials, and thus decreases the amount of waste that may enter waterways upon improper disposal. Plastic reduction can occur in a variety of steps along the supply chain of a product. Improving the production process to decrease the amount of plastic waste that is being generated and improving product design to reduce the amount of resin needed in the end product are two ways of achieving this.

---

Several companies have implemented material reduction strategies, including Nestle Water North America, the umbrella company of Poland Spring, Arrowhead, and Deer Park Water Bottles (Stevenson, 2011). The company redesigned their bottle and cap shape to use less plastic material. For example, for the Poland Spring bottle they reduced PET resin content from 14.5 grams per bottle to 9.2 grams. This reduction accounted for both plastic and energy savings, making the product even more sustainable (Stevenson, 2011).

However, it is possible that due to the use of thinner of materials the product may become more brittle and thus breakdown into smaller pieces more easily. If littered, faster breakdown may lead to faster plastic fragmentation that is more likely to be consumed by marine life. We recommend that plastic manufacturing companies investigate ways to reduce plastic use in product production, and that research be conducted on the environmental costs and benefits associated with products that uses less overall material.

### MICROFIBER FILTER ON WASHING MACHINES

Microfibers are entering wastewater treatment plants (WWTPs) from washing synthetic materials, such as polyester. It is difficult to determine where the fibers are ending up from the WWTPs, but it is possible that they settle into biosolids or end up in waterways. As discussed in the “The Impacts of Plastic Debris are Fairly Well Understood” Findings section, small particles may sorb potentially harmful chemicals that

can bioaccumulate as they travel up the food chain. To prevent this, we recommend development of a microfiber filter that could be added to personal and industrial scale washing machines. This filter would collect microfibers as water exits the washing machine. Due to fiber build-up the filter would most likely need to be changed after a certain period of time; similar to that of a lint collection system in a dryer.

### MATERIAL CHANGES

In addition to reducing the amount of plastic used in production of plastic goods, changing materials used for certain items provides another plastic reduction strategy. Promoting the purchase of longer lifespan items such as glass or metal food and beverage containers can lead to a reduction in plastic production. This idea also ties in with the container exchange programs discussed in the “Container Exchange and reduction Programs” Action Items section. By moving away from single-use plastics and replacing them with longer lifespan items, reuse will

become more of a common lifestyle change, and waste will decrease.

As discussed in the “Bans are Necessary: Plastic Grocery Bags and Polystyrene” Action Items section, there are multiple examples where suitable material substitutes can be found. An example of a material switch can be seen in the change from the nearly universal use of polystyrene popcorn in shipping materials to reduced plastic or non-plastic items such as cardboard that fulfill the same purpose.

---

Plastic bottles can be replaced with reusable aluminum or glass. Thin film plastic bags can be replaced with bags made from recycled bottles. Additionally, and perhaps more far reaching, companies can make material changes. For example, foam peanuts (or popcorn) used as packing materials are often replaced now with biodegradable

products, as well as recyclable plastic bags filled with air (Whitford, 1996). A second example is McDonald's, which has a long history of switching out takeout container materials used based on changes in consumer preference and emerging environmental concerns.

### McDonald's Case Study

An example of a product swap can be seen in the evolution of McDonald's clamshell product materials over the last 30 years.

When McDonald's first opened they used paper clamshells to serve their burgers. In the 1980s, in response to environmental groups who were concerned with the amount of trees used to make paper, they transitioned to polystyrene clamshells (Harvey, 2010). Later in the 1980s, environmentalists became concerned with polystyrene because its production used chlorofluorocarbons (CFCs), an ozone-depleting compound. In response, manufacturers stopped the use of CFC in their production process. This was followed later by public concern that polystyrene was not biodegradable, resulting in the subsequent switch back to cardboard clamshells by McDonald's (Moore, 2011; Harvey, 2010).

In this case, product material shifts were relatively easy and were driven by consumer concern and demand. Due to the fact that single-use plastic takeout products are such common litter items in the LA and SG River Watersheds, we recommend company-wide flexibility in the materials being used. Material changes, such as those described above, can be implemented in various places along the supply chain to reduce single-use plastic items that have suitable substitutes.

The EPA is adding source identification to its protocols for collecting and characterizing trash collected from beaches and waterways (A.M. Cook, Personal Communication, August 14, 2013). The EPA is compiling this information into a database. Their plan is to use this brand name identification to approach significant producers of plastics that end up as trash and partner with them

to develop cost-effective source reduction programs.

EPA tested this approach with Wal-Mart last year and the results were impressive (A.M. Cook, Personal Communication, August 14, 2013). Wal-Mart committed to a 25% reduction in the plastic packaging used by their third-party suppliers. In exchange, Wal-Mart saved \$3.8 billion in its first year

---

of implementing this strategy. Amazon implemented a similar program with its “Frustration-Free Packaging” campaign. Consumers embraced it and Amazon saved nearly \$3 million in transportation costs alone (A.M. Cook, Personal Communication, August 14, 2013). Capri Juice Drinks is presently being approached by the EPA

with respect to the plastic straws that come attached to their juice drinks. These are being found in abundance on beaches, at parks, and other recreational areas. The EPA is encouraging them to switch out the plastic for wax paper straws, or some other more benign material (A.M. Cook, Personal Communication, August 14, 2013).

### 6.3.2 HOMELESS ENCAMPMENTS SHOULD BECOME A PRIORITY

#### **Recommended Actions:**

- **Data collection on homeless encampments and their trash contribution**
- **Focus on long-term solutions such as housing**
- **Implementation of a suite of small approaches**

As shown in our findings, data on the exact contribution of plastic debris from homeless encampments is scarce; however, it is clear from our field trips to the river and the homeless encampment cleanup information that it is a plastic debris source of concern. These encampments, which are often located directly next to rivers in areas of high vegetation or under bridges, provide a source of direct improper disposal into the waterways that the current Trash TMDLs are not equipped to handle (Figure 6-7). Since

the plastic debris from these encampments will not pass through a catch basin before it enters the waterways, Zero Trash TMDLs (such as the LA River Watershed Trash TMDL) that emphasize catch basin installations to capture trash will not be effective at reducing the homeless encampment plastic debris contribution. Policies must be improved or enhanced at reducing the amount of plastic debris entering the waterways from these encampments.



*Figure 6-7 Trash and plastic debris in the Los Angeles River next to a homeless encampment in Long Beach. Photo: Michael Mori*

However, the issue of homeless encampments is perhaps one of the most burdensome for water quality agencies. It is not simply an engineering matter, such as installing a screen on a catch basin. Instead, it is a social issue with economical, sociological, and psychological factors. One of the most comprehensive reports on homeless encampments and water quality, Homeless Encampments in Contra Costa County by DeVuono-Powell, elaborates on this conundrum for water quality agencies:

*“While the (flood control district), staffed primarily by engineers, is very well equipped to deal with the environmental and structural challenges of maintaining water quality, it is*

*arguably less equipped to deal with the social challenges posed by the encampments set by the creeks.”*

To fully explore solutions to this problem is outside of the scope of this project. However, we recommend a few starting points, as the problem of homeless encampments contributing plastic debris to the LA and SG River Watersheds cannot be ignored if Zero Trash TMDL targets are to be reached. We recommend that agencies charged with reducing plastic debris from homeless encampments focus on data collection, long-term solutions, and a suite of smaller approaches.



---

## DATA COLLECTION AND INCREASED STAKEHOLDER COLLABORATION

---

The first step in dealing with homeless encampments for the water quality agencies in the LA and SG River Watersheds is to collect better data. Understanding the magnitude of the problem is difficult as detailed information on the number and location of camps is nonexistent and only scattered cleanup data exists.

Therefore, a comprehensive data collection plan on homeless encampments is proposed. First, all camps along the waterways should be mapped and their populations recorded. These records should be updated at least on an annual basis. Since there are multiple stakeholders involved in homelessness issues, including many organizations outside of water quality enforcement, coordination on this project should be emphasized to maximize resources and reduce costs.



*Figure 6-8 A bridge over the Los Angeles River in Long Beach that is used for a homeless encampment. Photo: Michael Mori*

Additionally, whenever a cleanup occurs, a common methodology should be established to record the quantity and characterization of trash. Coordination is key as there will be multiple stakeholders and jurisdictions involved in this process. Although jurisdictional complexity is cited as one of the greatest impediments to dealing with homeless encampments

(DeVuono-Powell, 2013), it is one of the many tough challenges that must be faced to further reduce plastic debris in the LA and SG River Watersheds. With comprehensive data on the number and location of camps and their trash contribution, proper attention will be brought to the issue and future solutions will be better targeted.

---

## FOCUSING ON LONG-TERM SOLUTIONS

---

Many of the current approaches to homeless encampments are only short-term solutions. Cleanups are the most poignant example.

While the police and other agencies will force campers to evacuate and cleanup what they leave behind, often times the homeless

---

encampment will return to the same area (DeVuono-Powell, 2013). Even when work is done to make the campsites undesirable (clearing out vegetation, etc.) or unattainable (new fences, etc.), the homeless will tend to move to the next available site, which is often nearby on the same waterway. This is because the socioeconomic factors that have created the homeless problem, such as high housing costs, high unemployment, mental health issues, and drug and alcohol abuse, still remain.

Therefore, to reduce the contribution of homeless encampments to plastic debris entering the waterways, more long-term solutions must be sought. Housing is the most important part of this equation, as well

as resources for employment, mental health care, and drug and alcohol issues. This would require additional resources and money to be spent on reducing homelessness, which is opposite of the trend of the past few decades (DeVuono-Powell, 2013). An additional wrinkle is that there are often issues with the homeless refusing shelter or housing and preferring to remain next to the river. A pilot study in Santa Clara that handed out housing vouchers during cleanups saw positive results (DeVuono-Powell, 2013). Despite these obstacles, if a reduction of plastic debris and improved water quality is sought by the water quality agencies in the LA and SG River Watersheds, a push for more investment in these resources for the homeless is necessary.

## A SUITE OF SMALLER APPROACHES

There are several smaller approaches to the homeless encampment plastic debris issue that could be implemented to improve the situation:

- **Creative trash collections.** An innovative program is to hand out garbage bags to members of a homeless encampment, and return a short time later to collect the bags while handing out a reward, such as food or bus tickets in return for each bag. A similar program in Curitiba, Brazil, has achieved great success (Gratz, 2013).
- **Employing homeless for trash cleanups.** Similar to above, the homeless can be employed to clean up the waterways or streets in reward for money and food. This provides additional trash collection as well as an avenue for the homeless to find employment and housing. Santa Clara County runs a program called Downtown

Streets Team that has used this approach to find full-time employment for the homeless in the area (Downtown Streets Team, n.d.), and has been successful enough to exponentially increase homeless employment since 2005 (Wilson, 2013).

- **Increased trash receptacles at homeless encampments.** Although there may be concern that this would acknowledge or encourage the siting of a homeless encampment, more trash receptacles would allow the camp residents to deposit their trash properly, which can be picked up by the city.
- **Adopt-the-River programs.** Sponsoring groups gain an intimate knowledge

---

with a section of river that they adopt. This will enable them to make contacts with the homeless and provide them assistance in a way that water quality agencies may be unable to provide. An Adopt-the-River program in Santé Fe, New Mexico led environmental groups

to provide trash bags and portable bathrooms on their sections of the river that had homeless encampments, which led to a decrease in the amount of trash and water pollution in the area (Sierra Club, n.d.).

This is not meant to be an exhaustive list of the possible approaches to the homeless litter problem. Even the smallest solutions require an increase in resources or cooperation, which are often impediments to taking action. However, with improved data collection and

an increased focus on the contribution of plastic debris by homeless encampments, both long-term and smaller approaches may prove to be more politically and economically feasible.

### 6.3.3 CALIFORNIA NEEDS MORE COMPREHENSIVE PLASTIC LEGISLATION AND A STATEWIDE TRASH POLICY

---

#### Recommended Actions:

- **Stronger coordination of state laws related to plastic source and waste reduction**
- **Statewide Trash Policy implementation**

Reducing plastic debris is not just an issue for legislators in the LA and SG River Watersheds – reduction can be achieved through stronger coordination of state laws and increased state regulation. In the state legislature, multiple bills are introduced every year that are related to reducing plastic

debris. These efforts would be more effective if these bills were combined. Additionally, a statewide trash policy enacted by the State Water Resources Control Board (SWRCB) would put limits on trash along the stretches of the SG River Watershed that are not currently regulated under a Trash TMDL.

#### STRONGER COORDINATION OF STATE LAWS

---

A multitude of bills aimed at plastic source and waste reduction are introduced in the state legislature every year (Table 6-7). While some of these bills become law and some do not, they all share the same characteristic of approaching one small part of the plastic debris problem. This piecemeal approach

is inefficient as it can lead to haphazard implementation of the law, overlap of implementation and enforcement between multiple agencies, and satisfaction with addressing the plastic debris issue without making significant progress.

**Table 6-7 Summary of proposed California legislation aimed at plastic source and waste reduction.**

Bill	Bill Description	Year Introduced/Current Status
AB 158: Single-Use Carryout Ban <sup>a</sup>	Large food-related stores cannot give customers single-use carryout bags.	Introduced 2013; stalled in Assembly Committee
AB 215: Solid Waste Recycling <sup>b</sup>	Would require 75% of solid waste be diverted from landfill by 2020	Introduced in 2013; passed Assembly but stalled in Senate Committee
AB 1021: Sales Tax Exemption for Recycled Feedstock Users <sup>c</sup>	If a company buys manufacturing equipment that utilizes recycled feedstock, it receives a sales tax exemption.	Introduced in 2013; passed Assembly but stalled in Senate Committee
AB 1023: Greenhouse Gas Reduction Through Recycling <sup>d</sup>	Would achieve greenhouse gas reduction by investing in recycling projects	Introduced in 2013; stalled in Assembly Committee
SB 529: Fast Food Recycling <sup>e</sup>	Fast food restaurants could not hand out single-use food containers unless 25% or more of the containers were recycled	Introduced in 2013; stalled in Senate Committee
SB 700; Carryout Bag Fee <sup>g</sup>	At food-related store, each customer wanting a carryout bag would be charged \$0.05; the money collected would be used for litter cleanup	Introduced in 2013; stalled in Senate Committee

<sup>a</sup> Assembly Bill No. 158. (2013, January 22). *Official California Legislative Information*.

<sup>b</sup> Assembly Bill No. 215. (2013, January 31). *Official California Legislative Information*.

<sup>c</sup> Assembly Bill No. 1021 (Eggman) - Sales Tax Exemption. (n.d.). *Californians Against Waste*.

<sup>d</sup> Assembly Bill No. 1023 - California 2013-2014 Regular Session. (n.d.). *Open States*.

<sup>e</sup> Assembly Bill No. 1370. (2013, February 22). *Official California Legislative Information*.

<sup>e</sup> State Bill No. 529. (2013, April 8). *California Legislative Information*.

<sup>g</sup> State Bill No. 158. (2013, February 22). *Official California Legislative Information*.

---

It is recommended that a comprehensive plastic bill be created and passed in the state legislature, combining the aspects of all the above bills. Coordination between agencies is key to reducing costs and increasing the efficiency of efforts to reduce single-use plastics, plastic packaging, and plastic debris. We recognize that this is politically

difficult, and the piecemeal approach may be a reflection of the difficulty of passing a bill that influences a multitude of stakeholders as comprehensive legislation would. However, for California to effectively reduce single-use plastic, plastic packaging, and plastic debris, such an approach is warranted.

### INCREASED STATE REGULATION

Due to the ongoing trash problems in the state, the State Water Resources Control Board (SWRCB) has been considering Trash Amendments to California's Water Quality Control Plans (SWRCB, 2013). These amendments would use a structure such as the LA River Watershed Trash TMDL to apply similar regulations to most of the waterways in the state.

A draft Staff Report including Substitute Environmental Regulation has been delayed from late 2013 to spring 2014 (M. de la Paz Carpio-Obeso, Personal Communication, January 7, 2014). This report will provide a template moving forward for a statewide trash policy. The focus of this document can be garnered from a public scoping document released in 2010 by the SWRCB (SWRCB, 2010), which gave notice to the public of the upcoming proposal and requested comments from stakeholders. The scoping document listed potential implementation methods for the statewide trash policy that were similar to the LA River Watershed Trash TMDL. Additionally, an NPDES General Permit

specific to preproduction plastic handlers and better management of nonpoint sources was proposed. If the statewide trash policy is to be implemented, it would likely be many years before it went into effect.

This policy would align with an overall goal of reducing plastic debris from California that enters the ocean, and would apply a trash policy to stretches of the SG River Watershed that are not currently covered under a Trash TMDL. For the LA River Watershed, beyond the current enforcement of the LA River Watershed Trash TMDL, preproduction plastic NPDES permits and nonpoint source controls would also reduce plastic debris entering the watersheds. However, it is recommended that a Trash TMDL specific to all stretches of the SG River Watershed be developed by the Los Angeles Regional Water Quality Control Board (as discussed in the "Implement a Comprehensive San Gabriel River Watershed Trash TMDL" Action Item section) while we await the issuance of the anticipated implementation of a statewide trash policy.



---

## 6.3.4 TRASH BOOMS COULD BE AN IMPROVED LAST LINE OF DEFENSE

---

### Recommended Action:

- **Introduce a system of multiple trash booms**

Trash booms are an effective way of preventing floating debris from the upper regions of a watershed from entering the ocean, as discussed in the “Long Beach Trash Boom and Beach” Findings section. They are also the only means of defense for capturing plastic debris once the debris has entered the waterways. They not only offer a means of collecting trash on a massive scale, powered solely by the flow of water, but also a chance to analyze the central issues of waste management in a watershed. Between the two rivers of interest in this study, only one trash boom is in operation at the mouth of the LA River. The operation of this boom requires a joint effort between the County of Los Angeles and its constituent cities, primarily the city of Long Beach. This coastal city is located at the mouth of the LA River and is consequently the most impacted by debris from the upper watershed flowing downstream.

The more effective use of trash booms would reduce the amount of floatable plastic debris that makes it to the ocean. Additionally, more thorough analyses of watershed trash can be conducted by measuring and characterizing the trash collected at the boom.

As discussed in the “Long Beach Trash Boom and Beach” Findings section of this report, the existing trash boom on the LA River captures anywhere between 15 and 64 tons of trash. While this is not an insignificant number, the design of the boom does not allow it to capture 100% of the floating debris that makes it to the mouth of the river. The device, which is angled upstream to increase resistance against the current, does not stretch across the full channel. This leaves a pathway for trash to bypass the trap. Studies for the Los Angeles River Watershed Trash TMDL defined a baseline waste load allocation of 2,826 tons of debris from the watershed and between 96 and 331 tons of trash is collected on beaches downstream of the Long Beach boom annually. This difference in what is produced by the watershed and what is captured may be due in part to submerged debris that is not captured by trash booms, but also includes debris that escapes the boom. In order to counteract this effect, solutions include the introduction of multiple trash booms in upper reaches of both rivers, as well as a boom that crosses the entire river width.

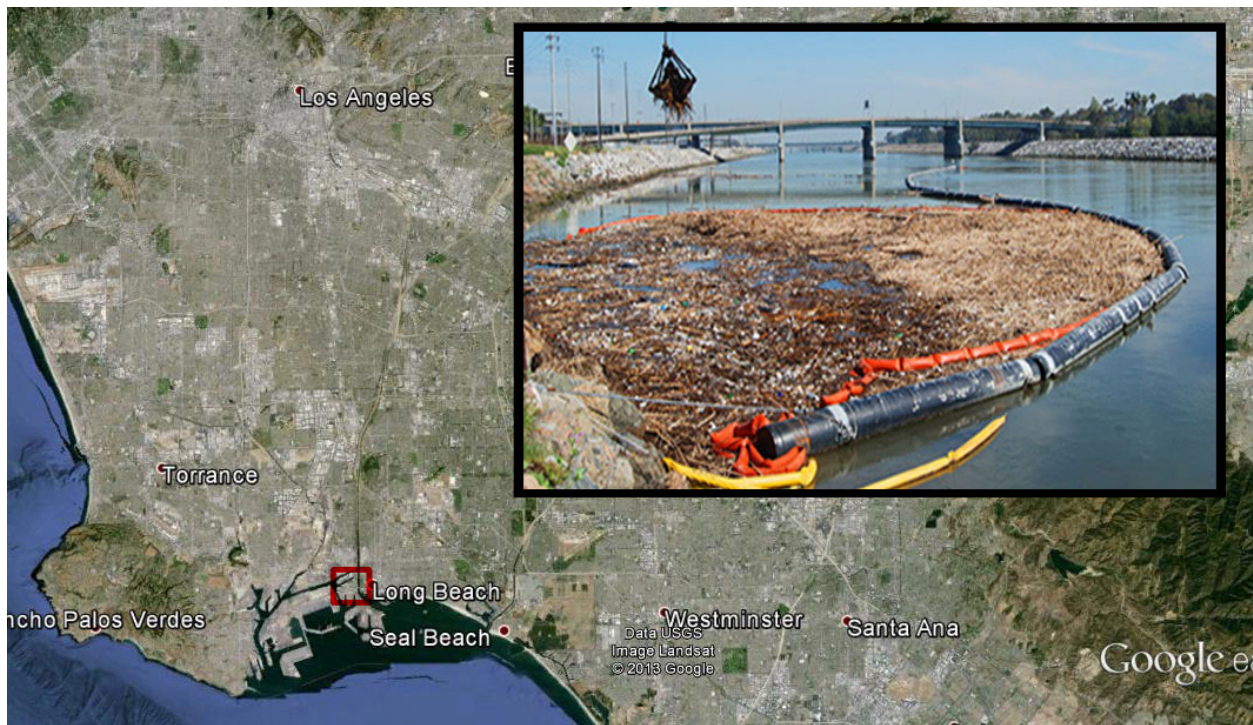

*Figure 6-9 The location of the LA River trash boom is in the red square and a close up image of the boom. Photographs courtesy of Google Earth and Los Angeles County, 2014.*

The introduction of a system of booms rather than a single one would be beneficial to the entirety of both watersheds by hosting a more secure network of trash capture, as well as diffusing responsibility of waste management amongst multiple entities. Multiple booms across the rivers would lead to a higher likelihood of trash capture as water flows downstream. This would be especially effective if booms were staggered, alternating between banks. If the booms were spread up the reaches of the rivers, they would be accounting for (and capturing) trash for smaller drainage areas.

In the case of the Long Beach boom, it is responsible for the entire watershed. A series of booms could be managed on a more local level. Since the debris would then be spread throughout the trash booms, volumes per

boom would be reduced and trash removal operations would need to be less frequent. In addition, the current boom is subject to tidal influences by which incoming tides tend to push debris out of the boom. Booms further upstream would not be influenced by these tidal forces and a larger portion of the watershed's floating debris would be recovered.

The placement of a boom that stretches across the entire mouth of either river could also be an option for trash management. As long as it is able to resist the current of the river, this solution would be able to capture more trash than the current boom system. Although it would not have the benefit of multiple parties taking local responsibility for trash management, its design would prevent tidal influences from removing trash

---

from the boom. This recommendation is a Tier 3 action item due to our uncertainty regarding the engineering challenges related to implementing this proposal.

Another recommendation for the region's trash boom(s) would be a more in depth analysis of the types of debris that is captured. Current practice removes the debris and transports it to a landfill. While this is practical from a waste management perspective, an opportunity is being missed

to characterize and quantify plastic debris in the watershed. This information would help to guide current and future policies aimed at preventing trash from entering the LA and SG Rivers in the first place. The segregation of plastic debris from other types of trash and recording its weight, count, volume, and size, and then further characterizing the debris by type of plastic would be beneficial for informing policy decisions about litter and waste management.

### 6.3.5 DECLARE PLASTIC A HAZARDOUS SUBSTANCE

---

#### **Recommended Action:**

- **The EPA should declare plastic as a hazardous substance**

Plastics are made with a variety of known toxins, which are detailed in the "Composition" Background section. These toxins are believed to work their way up through the food web where they may eventually be consumed by humans. Toxic chemicals have been shown to sorb to plastic debris, especially in the marine environment. Plastics contain toxins that leach out as they degrade. Plastic debris also serves as floating devices for harmful bacteria and other invasive organisms. Scientific research has not yet been able to conclusively demonstrate these connections, but there is growing consensus on the potential for plastic debris to pose a significant danger to human health and the environment.

We suggest that even though scientific debate continues over these toxic effects, we should exercise the precautionary principle and declare plastics as a hazardous substance. Industry should shoulder the burden of

proof in showing that their products are not harmful, not the other way around.

Declaring plastic as a hazardous substance, rather than a pollutant of concern (the current designation), would allow the EPA to invoke their regulatory powers under the Comprehensive Environmental Response, Compensation, and Liability Act of 1980 (CERCLA) and fund the cleanup of vast land- and ocean-based sites identified as having large accumulations of plastic debris (A.M. Cook, Personal Communication, February 14, 2014).

Such a declaration would also have the added benefit of encouraging the plastics industry to develop new and innovative products that do not contain harmful toxins. Such an action may also lead to the development of closed loop systems where plastic products are reused and formed into new products, rather than ending up in landfills or the environment.

---

## 6.3.6 COMPOSTABLE PLASTIC IS NOT QUITE READY FOR THE MAINSTREAM

---

### Recommended Actions:

- **Develop a standardized labeling system for compostable products**
- **Continue the development of marine compostable plastic**

Compostable materials are becoming a more popular alternative to conventional plastics. Due to a limited and ill-defined labeling system for compostable items and very specific breakdown requirements, we recommend continuing the development of compostable plastics before implementing their widespread use.

### COMPOSTABLE PRODUCT LABELS

---

#### *Land Compostability*

There are many plastic items that claim to be certified as a “green” product. Certification, however, can be done by industry associations and not independent third party entities with appropriate expertise for certifying a product. Additionally, certification may be based on only one or a few qualities and not accurately represent the environmental benefits of the product.

Official compostable certification should meet ASTM international standards (formerly known as the American Society for Testing and Material). These standards for compostable materials fall under ASTM D6400-12 Standard Specification for Labeling of Plastic Designed to be Aerobically Composted in Municipal or Industrial Facilities. Compostable plastics that are certified with these standards are often (but not always) labeled with a logo of a leaf and a tree arrow (Figure 6-10).

Lack of required labeling, as well as the inconsistent use of the terms compostable

and biodegradable, has led to a confusing system that would benefit from becoming more consumer-friendly. As was discussed in the “Increase Recycling Rates” Action Item section, better labeling will allow consumers to understand the products they purchase, empowering them to make proper disposal decisions. Standardization of labels decreases confusion and increases awareness.

It is recommended that a comprehensive global labeling guide for compostable plastics be developed. Due to the strict guidelines provided under the ASTM standard, we recommend all compostable materials use the ASTM standard and label (Figure 6-10). Additionally, since the conditions of compostability are variable, we recommend that the product label contain information on the specific conditions required for breakdown. This information should be provided to the customer on the item label.



*Figure 6-10 Compostable plastic certification label. (Photo: Michael Mori)*

### *Marine Compostability*

Due to the high percentage of plastics that have been observed within the LA and SG River Watersheds and the ocean, continued development of marine compostable plastics provides a possible solution. If the materials can only be decomposed in the marine environment, then their proper disposal will require them to be landfilled. If the item is labeled as marine compostable people may think that it is acceptable to litter plastics

directly into the ocean. Due to the time it takes for items to decompose, as well as the possibility of chemical leaching upon decomposition, direct littering would further increase many of the marine issues discussed in this report. We recommend that marine compostable materials be further researched before recommending compostable plastics for widespread use.



---

## 7 CONCLUSIONS

---

Plastic debris is one of the most pressing environmental issues of our time.

Given the long lifespan of plastic and its detrimental effects on wildlife, humans, and the economy, a better understanding of how plastic debris is entering the environment is imperative. This project analyzed the types, sources, transport, and fate of plastic debris in the Los Angeles and San Gabriel River Watersheds (LA and SG River Watersheds). Based upon this analysis, action items were recommended to reduce plastic debris.

Plastic debris is ubiquitous in the environment. As our interviews, literature review, site visits, and data analyses showed, if you look closely enough, plastic debris can be found on nearly all of the streets, rivers, beaches, and oceans of the world. Half of the trash that is in the ocean is from land and comes mainly from littering; half of that trash is plastic and the majority of that plastic debris is single-use items. Our data analyses in the LA and SG River Watersheds showed similar plastic as a percentage of trash as global-, national-, and state-level studies.

Our study region has recognized the plastic debris problem, and the various laws and regulations that have been implemented to address this are effective to an extent. Innovative Trash Total Maximum Daily Loads (TMDLs) have been enacted for the entire LA River Watershed and parts of the SG River Watershed, but they are not effective at capturing plastic debris from open areas,

debris that is smaller than 5 mm in size, and litter.

Industrial Stormwater General Permits have strong language to contain smaller than 5 mm preproduction plastic materials from industrial facilities, but there is a lack of funding to enforce them. Our analysis of plastic facilities showed that spills are commonly accepted within the industry and that adoption of voluntary BMPs (e.g., Operation Clean Sweep) is low.

Microplastics are an emerging pollutant that scientific studies are beginning to find in the environment. These microbeads and microfibers that enter wastewater treatment plants (WWTPs) are not currently regulated, and they are not on the radar of WWTP personnel in the region.

The Tier 1 Action Items proposed are a combination of highly effective and highly feasible policies that stand the greatest chance of reducing plastic debris in the LA and SG River Watersheds. However, all of our recommended Action Items would require at least some additional resources or commitments from strained governmental agencies or businesses, in an economic time when only the most direct environmental threats to human health receive significant attention.

Large investments in infrastructure to capture plastic debris, such as those necessary to comply with the LA River Watershed Trash

---

TMDL and litter cleanups, are necessary. However, they can only go so far to reduce the amount of debris entering the rivers, washing up on beaches, and floating out to sea. The issue becomes as much of a social one as an engineering one – until people take care of their trash and stop littering, there will always be plastic debris in the environment. A greater expansion of litter law enforcement, extensive anti-litter education, and promotion of a culture of reuse, is a step in the right direction toward changing this human behavior.

In the end, we must acknowledge as a society that it is imperative to stop plastic debris from entering the environment. If set as a top priority, there are effective and feasible solutions to reducing plastic debris, such as the 16 Action Items we have recommended in this report.

**The Los Angeles River**  
**Photo: Michael Mori**

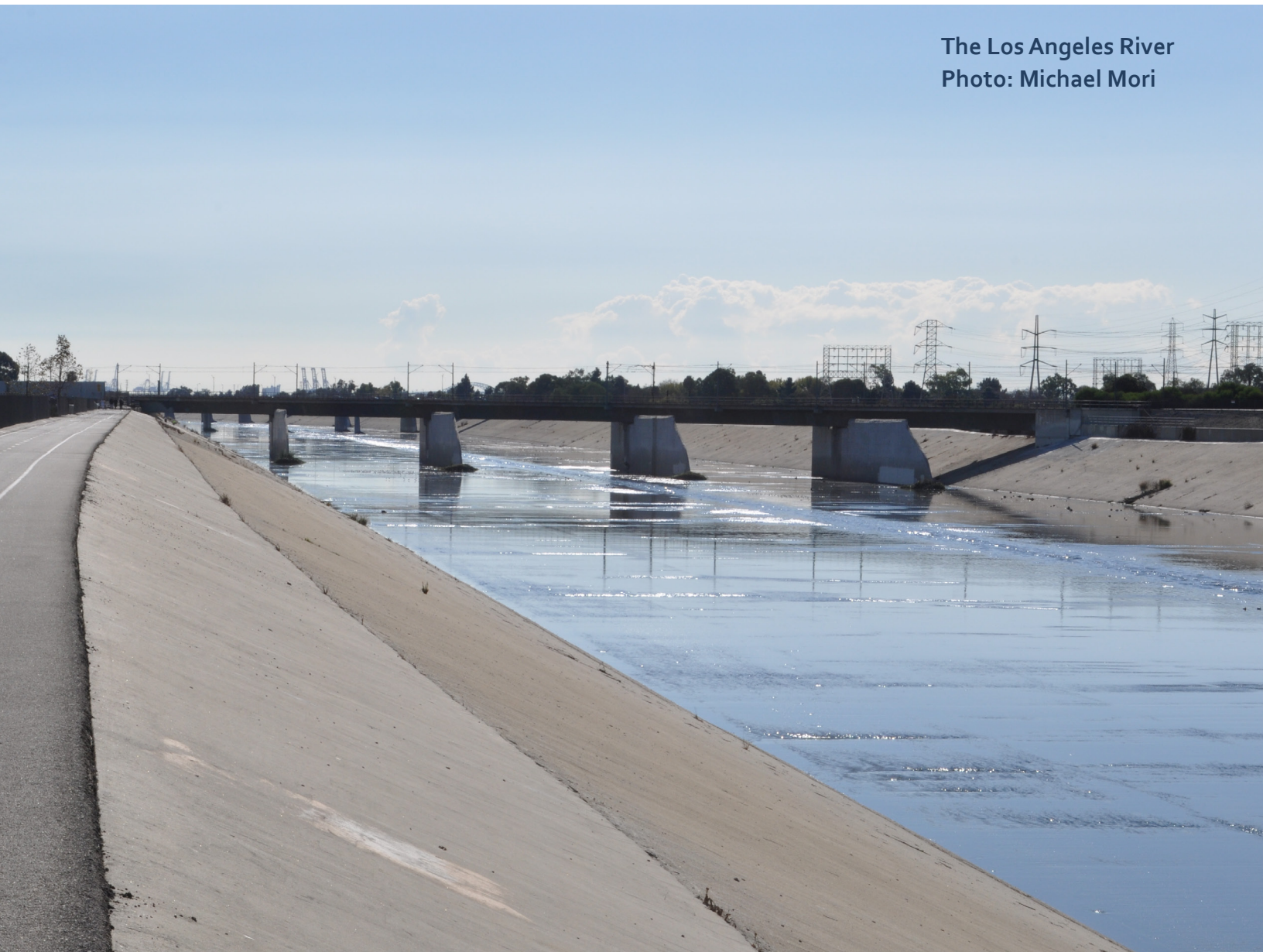

# Appendices

---

# APPENDIX A - FIGURES

---

Figure 3-1 Los Angeles and San Gabriel River Watersheds .....	20
Figure 5-1 The five subtropical gyres around the world .....	29
Figure 5-2 The impact, sources, method of litter, and transport of plastic debris in the Los Angeles and San Gabriel River Watersheds .....	41
Figure 5-3 Cities and compliance status under the LA River Watershed Trash TMDL as of 2012 .....	43
Figure 5-4 A Catch Basin Insert .....	49
Figure 5-5 Trash debris in the LA and SG River Watersheds .....	50
Figure 5-6 Data from three separate studies, summed by land use and plastic as percent of total trash .....	55
Figure 5-7 Top 6 categories of trash by count, weight, and volume in the City of Los Angeles from July to August .....	56
Figure 5-8 Map of data points in the TMDL zone, and reference zones .....	57
Figure 5-9 Average abundance per sample site results of ANOVA of plastic types among the watersheds .....	58
Figure 5-10 Long Beach trash boom collection data compared to precipitation .....	60
Figure 5-11 Beach cleanup data below Long Beach trash boom compared to precipitation .....	61
Figure 5-12 Plastic as a percent of total trash at Herondo Drain .....	62
Figure 5-13 Percent composition ranges by count for the most common plastic debris types in our study region .....	63
Figure 5-14 The percent plastic debris in the LA River Watershed by land use .....	67
Figure 5-15 The percent plastic debris in the SG River Watershed by land use .....	68
Figure 5-16 The contribution of plastic debris per land use for each type of plastic debris in the Los Angeles River Watershed .....	69
Figure 5-17 The contribution of plastic debris per land use for each type of plastic debris in the San Gabriel River Watershed .....	69
Figure 5-18 Change in Litter since 1969 .....	71
Figure 5-19 Estimates of microplastics discharged from WWTPs into the Los Angeles River and San Gabriel River in count and weight per year .....	78
Figure 5-20 Types of polymers used .....	83
Figure 5-21 Industry production volume .....	84
Figure 5-22 General procedures for spill prevention and response .....	85
Figure 5-23 Commonly implemented best management practices .....	85

---

Figure 5-24 Operation Clean Sweep participants .....	87
Figure 6-1 Policies to reduce plastic debris, ranked by feasibility and effectiveness.....	89
Figure 6-2 Polystyrene cups collect in a storm drain that opens to the San Gabriel River .....	98
Figure 6-3 Containers that are eligible for the California Redemption Value refund .....	104
Figure 6-4 A CDS unit schematic.....	108
Figure 6-5 Sample reference photographs can help identify the sizes of debris .....	111
Figure 6-6 Universal Recycling Symbol.....	116
Figure 6-7 Plastic debris in the Los Angeles River next to a homeless encampment .....	123
Figure 6-8 A bridge over the Los Angeles River that is used for a homeless encampment .....	124
Figure 6-9 The location of the LA River trash boom .....	130
Figure 6-10 Compostable plastic certification label .....	133



---

## APPENDIX B - TABLES

---

Table 3-1 Thermoplastics – Descriptions and Uses.....	18
Table 5-1 Cities in compliance with the LA River TMDL by installing a higher percentage of full capture systems than the 70% trash reduction required by 2012.....	44
Table 5-2 Cities in compliance with the LA River TMDL by having their monitored level of trash lower than their waste load allocation.....	46
Table 5-3 City Compliance with the LA River Watershed Trash TMDL.....	47
Table 5-4 Summary of Datasets.....	53
Table 5-5 Plastic observed along four 200-foot transects with land uses in Fullerton Creek.....	55
Table 5-6 Sum of trash collected at Herondo Drain.....	62
Table 5-7 Percent contributions to differences in composition of plastic debris in the Los Angeles and San Gabriel River Watersheds.....	66
Table 5-8 WWTPs in the LA and SG River Watersheds and their estimated effluent per day.....	77
Table 6-1 Plastic Grocery Bag Global Policy Actions.....	92
Table 6-2 Plastic Bag Bans Enacted in or near the LA and SG River Watersheds.....	96
Table 6-3 Polystyrene Bans Enacted in or near the LA and SG River Watersheds.....	97
Table 6-4 Items covered under the California Redemption Value Program.....	104
Table 6-5 Summary of the types of information provided by different studies.....	113
Table 6-6 Recycling rates by material type in 2012.....	116
Table 6-7 Summary of proposed California legislation.....	127

---

# APPENDIX C – PLASTIC DEBRIS LITERATURE REVIEW

---

## LITERATURE REVIEW TABLE OF CONTENTS

---

HISTORY.....	A-6
SOURCES OF MARINE PLASTIC.....	A-8
COMPOSITION.....	A-14
QUANTITY.....	A-17
ACCUMULATION IN THE MARINE ENVIRONMENT.....	A-19
IMPACTS.....	A-21
THE WATERSHEDS.....	A-29
POLICY.....	A-33

---

## HISTORY

---

Plastics are nothing new to the history of humankind. Ancient cultures dating back to 1600 BC learned to turn natural rubber into useful items, including balls, sculptures, and even adornments (Andrady et al., 2009). Over the next 250 years, humans experimented with many different forms of natural polymers and resins, waxes, and rubber (Andrady et al., 2009). In *Our Plastic Age*, Thompson et al. (2009), provides a concise history of modern plastics. Polystyrene and polyvinyl chloride (PVC) were invented in 1838 and 1872, respectively. Bakelite was developed in 1907 and is considered to mark the emergence of the modern plastics industry (Cole et al., 2011; Thompson et al., 2009). The commercial production of PVC began in the 1920s, followed closely by polystyrene in the 1930s. Polyethylene was fabricated in 1933 and polyethylene terephthalate in 1941. By the 1940s, the mass production of plastics had begun, with the current global production of plastics estimated to be approximately one million tons per year (Hirai et al., 2011; Plastics Europe, 2010).

Plastics were a revolutionary material at the time of their discovery because they were light, durable, strong, and inexpensive, and they could be used to produce a plethora of products that were useful to both industry and consumers (Derraik, 2002). In 1945, the chemists Yarsley and Couzens marveled at the invention in a *Science Digest* article (Thompson et al., 2009). Credited with coining the term the "Plastic Age," they wrote a book that same year entitled "Plastics," describing the life of a person born 70 years after the beginning of the "Plastic Age":

*"This [imaginary] plastic man will come into a world of colour and bright shining surfaces where childish hands find nothing to break, no sharp edges, or corners to cut or graze, no crevices to harbor dirt or germs .... The walls of his nursery, his bath ... all his toys, his cot, the moulded light perambulator in which he takes the air, the teething ring he bites, the unbreakable bottle he feeds from [all plastic]. As he grows he cleans his teeth and brushes his hair with plastic brushes, clothes himself within plastic clothes, writes his first lesson with a plastic pen and does his lessons in a book bound with plastic. The windows of his school curtained with plastic cloth entirely grease- and dirt-proof ... and the frames, like those of his house are of moulded plastic, light and easy to open never requiring any paint. [and as he reaches old age] ... wears a denture with silent plastic teeth and spectacles with plastic lenses ... until at last he sinks into his grave in a hygienically enclosed plastic coffin."*

~Yarsley and Couzens (1945)

Synthetic plastics provided many benefits over natural materials in a wide variety of

---

applications. Plastic products are credited with numerous health benefits by providing clean drinking water supplies, medical devices, and food packaging that reduces spoilage and transportation damage. Other benefits include a reduction of transportation costs due to their lightweight, energy-saving applications, durability, and low cost (Andrady et al., 2009).

A byproduct of the growth of plastic use, plastic litter went largely unnoticed until the 1970s because it was considered a minor problem that was primarily aesthetic in nature (Derraik, 2002; Laist, 1987). That changed as major newspapers such as *The New York Times* began reporting on the subject, with headlines as early as 1971 such as “We are Killing the Sea Around Us” (Harwood, 1971) and “The Very Dirty Sea Around Us” (Lyons, 1973). The main concern during this period was petroleum pollution, but scientists soon discovered that plastics were also appearing in the world’s oceans (Derraik, 2002; Gregory, 1983; Laist, 1987; Shaw, 1977; Shaw et al., 1979; Wong et al., 1976). Scientists studying wind and ocean circulation began considering how those patterns might affect the flow of oil, plastics, and other pollutants (Shaw et al., 1979; Wong et al., 1976). As research continued into the 1980s, there was an increasing awareness that plastics were generating a waste management problem of significant local and global proportions (Gregory, 1983; Laist, 1987; Pruter, 1987). Numerous nonprofit organizations also emerged during this period with a specific focus on addressing the problem of plastic debris in the environment.

By the mid- to late-1980s, the presence of plastics in the marine environment had been well documented and scientists, nonprofits, and governments turned their attention toward the sources, quantity, and distribution of those plastics (Day et al., 1987; Derraik, 2002; Gregory, 1983; Laist, 1987; Pruter, 1987; Wolfe, 1987). In 1989, the National Oceanic and Atmospheric Administration (NOAA) created a model that predicted the presence of a plastic gyre in the North Pacific Ocean. This model was based on research conducted in Alaska between 1985 and 1988 and was presented at the Proceedings of the Second International Conference on Marine Debris (Day et al., 1990; NOAA, 1990).

For the past two decades, scientific research into plastic debris has begun to focus on the breakdown of plastics into smaller particles, commonly referred to as “microplastics” because they are small particles of plastic. This can be misleading; however, because they are still visible to the naked eye. The common scientific definition of a “microparticle” is an object that is less than 1 mm in size, but the term “microplastic” has been commonly used to describe a plastic object that is less than 5 mm in size (e.g., Arthur et al., 2008; Bakir et al., 2012; Thompson et al., 2004). In keeping with the common interpretation and understanding of the term in the scientific and popular literature on plastic debris, we also will refer to microplastics generically as plastics less than 5 mm in size, even though a “microplastic” would be more properly defined as plastic less than 1 mm in size (Browne et al., 2011).

---

A more complete classification for plastic debris that helps resolve this terminological conflict was recently used in a study conducted on beaches in South Korea, categorizing particles into four size classes: small microplastics (< 1 mm), large microplastics (1-5 mm), mesoplastics (5-25 mm) and macroplastics (> 25 mm) (Lee et al., 2013). Where clear discrimination is needed we will use this terminology as well.

The current state of knowledge concerning the sources, abundance, composition, and impacts of plastics, and the policies that have been put into place to regulate their entry into the environment, are reviewed in the following sections. A discussion is also included of the available information specific to the regions under study, the Los Angeles River and San Gabriel River Watersheds.

---

## SOURCES OF MARINE PLASTIC

---

Given the ubiquitous presence of plastic in modern life, marine plastic debris is widespread and varied, with many difficulties in quantifying sources, types, and quantities of plastic that enter the marine environment (Allsopp et al., 2006; Gordon, 2006; Kershaw et al., 2011; Ribic et al., 2012; Sheavly, 2007; Stevenson, 2011; WCGA, 2013; WSI, 2011). Much of the plastic that ends up as debris has fragmented or degraded by the time it is collected (WSI, 2011; Stevenson, 2011). Ocean transport mechanisms make it difficult to identify the source of a piece of plastic debris (NOAA, 2008; Stevenson, 2011). Wind circulation patterns can also redistribute plastic far from its originating source (NOAA, 2008; Stevenson, 2011). The sources of floating and submerged plastic debris in nearshore and open-ocean environments are understudied (NOAA, 2008; Stevenson, 2011). Plastic debris can originate from different land-based sources but accumulate during storm events, complicating source identification (NOAA, 2008; Stevenson, 2011). Finally, methodologies and standards vary greatly with respect to plastic debris collection efforts (Stevenson, 2011). Studies

often record only density, count, or weight of plastics.

Plastic sources are broadly categorized as either land- or ocean-based (Gordon, 2006; Kershaw et al., 2011; NOAA, 2008; Stevenson, 2011). The National Marine Debris Monitoring Program (NMDMP), developed by the Ocean Conservancy with the support of the EPA, is a recent effort to standardize marine debris collection methods to assess sources and trends in the U.S. (NOAA, 2008). Their research determined that 49% of all debris found on beaches came from land-based sources, with no significant change in the volume over the five-year study period (Sheavly, 2007). An additional 33% was estimated to have come from either land- or ocean-based sources because the exact source could not be assessed (Sheavly, 2007). Plastics have consistently made up the majority (between 60%-80%) of marine debris over the past couple of decades (Keller et al., 2010; Kershaw et al., 2011; Ribic et al., 2012; WSI, 2011).

The focus of this report will be on land-based sources, which fall into six general categories:



---

municipal landfills; litter and waste generated in coastal and inland zones from improper waste disposal; transport of litter and waste (on land or waterways); stormwater discharge; industry and manufacturing; and storm events (Allsopp et al., 2006; Gordon, 2006; Sheavly, 2007; WSI, 2011). Land-based sources are variously estimated by different studies to constitute between 50%-80% of all marine debris worldwide (Allsopp et al., 2006; Gordon, 2006; Ribic et al., 2012; Sheavly, 2007; Stevenson, 2011; WCGA, 2013; WSI, 2011). Plastics can also be sourced by their original type, either debris composed of fragments of manufactured plastic (user plastic) or preproduction plastic pellets (industry plastic, with the pellets commonly called “nurdles”) (Derraik, 2002; WSI, 2011). By count, smaller sizes of plastic debris (<5 mm), or microplastics, make up the majority of plastic debris (Stevenson, 2011).

Population size has been correlated with land-based contributions of plastic debris – regions with larger populations tend to have higher debris loads (Barnes, 2005; Ribic et al., 2012; Stevenson, 2011). Land use has also been correlated with plastic debris sources (Gordon, 2006; Moore et al., 2005). Commercial land use is consistently associated with higher loads of debris of all kinds when compared with residential and mixed land uses (Gordon, 2006; Moore et al., 2005)

Assessing the sources of microplastics is still an emerging research area, as very little is known about their abundance, density, and distribution within the environment (Cole et al., 2011; Derraik, 2002; Thompson et al., 2004). In a study conducted in 2011,

Stevenson suggests that plastic micro-debris is more properly sourced into two categories: primary microplastics (intentionally made small and used in the manufacture of plastic products or as additives to skincare products) and secondary microplastics (the result of fragmentation of larger pieces of plastic into smaller sizes).

The most commonly identified plastic debris item is single-use food packaging (Stevenson, 2011; WSI, 2011). A comprehensive study conducted in 2011 found that approximately 50% of all plastics are manufactured into single-use disposable packaging (Stevenson, 2011). The Ocean Conservancy-sponsored beach cleanups found an abundance of food packaging amongst the top ten most common debris items: cigarette butts and filters; plastic beverage bottles; plastic bags; caps/lids; food wrappers and containers; cups, plates, forks, knives and spoons; glass beverage bottles; straws and stirrers; beverage cans; and paper bags (OC, 2011).

Up until recently, many source identification efforts came from the characterization of trash collected at cleanup events conducted primarily along beaches, rivers, and other recreational areas. Due to their small size, microplastics likely went unnoticed. Recent efforts have sought to fill this information gap by designing surveys that incorporate protocols for identifying microplastics. In one such study, preproduction pellets, foam plastics, and hard plastics were identified as common plastic debris found on Southern California beaches (Moore et al., 2001).

---

## MUNICIPAL LANDFILLS

---

Approximately 10% of all solid waste in the U.S. is composed of plastic (Barnes et al., 2009; Cole et al., 2011; Derraik, 2002; WSI, 2011). According to the EPA, plastics as part of the municipal solid waste system increased from 1% in 1960 to nearly 13% in 2011 (WSI, 2011). The most abundant category was containers and packaging (WSI, 2011). In California, a study conducted by the California

Integrated Waste Management Board in 2004 and 2008 ranked plastics as the second-largest category of waste entering landfills, just behind paper items (Stevenson, 2011). The study also revealed that packaging represented 23% of the total plastic entering landfills; 13% was plastic grocery and trash bags (Kershaw et al., 2011; Stevenson, 2011).

## LITTER AND WASTE

---

Trash that is improperly disposed of has the potential to end up on streets, in stormwater systems, and in waterways (EPA, 2013; NOAA, 2008). Besides illegal disposal (littering), improper disposal can occur where there is a lack of infrastructure to capture plastic debris, such as trash cans without lids, overfilled trash cans at events, public parks, recreational areas, and beaches (OC, 2011). If adequate disposal alternatives are unavailable or costly, plastics (and other trash) may be illegally or improperly disposed of (EPA, 2013; NOAA, 2008). There are some studies that provide accurate quantitative measurements for trash released accidentally into the environment, but until very recently, plastic debris has not been broken out as a separate component, making source identification and quantification problematic (Stevenson, 2011; Kershaw et al., 2011).

An action plan was developed in 2006 for California to reduce land-based discharges of plastic debris into the environment (Gordon, 2006). The plan points out that “there is no viable way to remove this pervasive problem from the world’s oceans” – plastic debris

must be stopped before it flows to the ocean. Urban runoff was identified as a primary source of marine debris, and the primary source of trash in urban runoff was judged to be litter that was either intentionally or accidentally released. In the Los Angeles River Watershed, industrial land uses were found to have higher litter rates than either commercial or residential areas.

Litter that is not picked up through street sweeping, voluntary cleanups, and catch basin systems has the potential to end up in rivers and make its way to the ocean. The California State Water Resources Control Board launched a two-year public awareness campaign for Los Angeles County in 2003 called “Erase the Waste,” to address the problem of litter entering storm drains. Using a regression model developed by their Stormwater Program staff, Caltrans, and researchers from California State University Sacramento and University of California, Davis, they were able to estimate the number of times that individuals engaged in polluting activities. The model essentially reverse engineers the littering process using the litter

---

volume found on freeways and expressways. Updated in 2007, the model estimates that in just one month litter is thrown on the ground or out of a car 830,000 times; blows onto a street more than 800,000 times; and ends up in a storm drain close to 280,000 times in Los Angeles County (CWB, n.d.; CEPA, 2009).

Caltrans characterized litter by examining the contents of freeway catchment basins in California during storm seasons over a two-year period from 1998 to 2000 (Lippner et al., 2001). Moldable plastics represented the largest component, by volume, of the trash collected and analyzed – cigarette butts were the largest category, by count (Lippner et al., 2001). The researchers pointed out; however, that identifying the source of the trash was not possible due to the small sizes of the majority of pieces collected (Lippner et al., 2001). A similar study conducted in Mississippi in 2000 focused on developing a baseline characterization of litter to aid the state in addressing their litter problems (Gordon, 2006). More than half of the litter was plastic, with single-use plastic food containers, cups, and napkins representing 27% of the total litter collected and another 33% of the items being other plastic products.

A 2012 study at the Fullerton Creek Watershed in Orange County found that 48% of all trash collected over a four month period was plastic (Furman, 2013). Trash was collected along four transects downstream of the Fullerton Creek outfall. Each transect was associated with different land use types: parks and recreation; industrial,

commercial, and overpass/bridge; residential, commercial, and overpass/bridge; and residential, industrial, commercial, parks and recreation, an overpass/bridge, freeway, railroad, and homeless encampment. The largest accumulation of debris (38%) occurred in a monitoring site associated with the widest variety of land uses. The two sites that differed only between residential or commercial land uses accounted for 50% of the total trash collected (25% each). The site that was located in a public park was the least impacted (12%), but it was hidden from view by vegetation. Furman (2013) concluded that the close proximity to a freeway and homeless encampment were the major contributing factors to the increased levels of trash at this transect. The study was limited in sample size, did not compare wet and dry seasonality, and counted only trash that was less than 5 mm, but still provides useful information about how the association between land use and trash accumulation could be explored in future research. In particular, a similar study that further delineated land use and included microparticle-sized trash would be informative.

A Friends of the Los Angeles River trash cleanup effort conducted in 2011 (Tyack, 2011) found plastic film (primarily single-use plastic bags and snack and candy wrappers) to be the most abundant item. Single-use plastic food packaging and polystyrene were also in the top five categories found.

---

## TRANSPORT OF LITTER AND WASTE

---

Land-based sources of plastic debris can be transported by the wind or washed out to the ocean by rivers (Allsopp et al., 2006; Gordon, 2006; NOAA, 2008). Plastic, due to its lightweight characteristics, has the potential to be blown from one place to another, making source quantification difficult. This literature review of more than 300 peer-reviewed journal articles, agency white papers, and other reports did not yield any indication of attempts to quantify wind transport as a source of plastic debris.

Plastic can also enter the environment during transport to landfills if trucks are not adequately designed to contain their haul (NOAA, 2008; WSI, 2011). Accidental spills can also occur at trash collection points (NOAA, 2008; WSI, 2011). Los Angeles County landfill operators estimate they spend approximately \$25,000 per landfill gathering single-use bags that are lost during collection, transport, or at the facilities, despite their implementation of BMPs such as truck covers and fencing at facilities (COLA, 2007).

## STORMWATER DISCHARGE

---

On a regional level, 43% of the litter trapped in California storm drains by catchment inserts was plastic (Stevenson, 2011). This is a strong indication of the transport of plastics from the land to the ocean via waterways. The report, which covered the entire state, indicated that the sources of this litter were difficult to assess because the pieces were too small for identification purposes (Stevenson, 2011). Stormwater systems are prohibited by law from discharging plastics into waterways (to the maximum extent practicable); however, during storm events excessive rainfall may exceed their capacity, resulting in accidental discharges (NOAA, 2008; Sheavly, 2007; WSI, 2011).

The Los Angeles Regional Water Quality Control Board limits the maximum amount of trash that can enter a water body through a municipal stormwater system with Trash Total Daily Maximum Loads (TMDLs). To comply with the Trash TMDL in the Los Angeles River Watershed, many catchment inserts have been installed that have mesh screens that capture any object greater than 5 mm in size, so theoretically the amount of plastics entering the waterways through storm drains has been reduced (LARWQCB2, 2007). Trash TMDLs are discussed in detail in the Policy section.

## WASTEWATER TREATMENT PLANT DISCHARGE

---

Microplastics have multiple sources: plastic scrubbers used in facial cleansers and cosmetics, industrial processes where microparticles are blasted at machinery to remove rust or paint, fibers from the laundering of synthetic fabrics containing

plastic materials, and the breakdown of larger plastic particles after they enter the environment (Arthur et al., 2008; Browne et al., 2011; Cole et al., 2011; Derraik, 2002; Fendall et al., 2009; Thompson et al., 2004).

---

Many wastewater treatment plants discharge their treated waters into rivers, and those discharges can include plastic microparticles that have the potential to enter waterways and ultimately discharge to the ocean.

Tertiary treatment conducted by wastewater treatment plants does not, at present, remove all microplastics – ultrafiltration systems would be needed to accomplish this (Browne et al., 2011).

## INDUSTRY AND MANUFACTURING

---

The plastics product industry is identified as the key customer for plastic resins (ACC, 2013). California ranks third in U.S. plastics component production in terms of its size, number of employees, and exports (Stevenson, 2011; KEMA, 2012).

It is currently estimated that one-third of total annual global plastic production is dedicated to packaging, another one-third to construction materials, and the remaining one-third comes from a mixture of uses ranging from automobiles to toy and furniture products (Andrady et al., 2009; Lebreton et al., 2012; Plastics Europe, 2012; Thompson et al., 2009). The U.S. plastics industry reports that packaging represented 42% of total production in 2012 (ACC, 2013). The American Chemistry Council, a U.S. plastics industry trade association ranks their “big six” plastic resins in order of production: polyethylene, polypropylene, polyvinyl chloride, polystyrene solid and expandable, polyethylene terephthalate, and polyurethane (ACC, 2013).

Industry and manufacturing processes involve the use of raw materials in the forms of plastic resins, powders, and preproduction pellets. Plastic pellets (commonly called nurdles or preproduction pellets) are the raw materials used to form or mold plastics for a multitude of commercial products (Arthur et

al., 2008; Barnes et al., 2009; Derraik, 2002; McDermid et al., 2004). Preproduction pellets are thought to enter the environment mainly through accidental spills during transport or handling (Arthur et al., 2008; Derraik, 2002; EPA, 1993; Moore, 2013). Rail yards have been identified as a potentially significant source of preproduction plastic pellet loss, especially during rainfall events (Gordon, 2006; Stevenson, 2011). Rail yards are used to store railcars before they are offloaded. According to the Santa Ana Regional Water Quality Control Board, accidental spills occur fairly often during this process due to vacuum pump failures and leaks from hoses used to suck the pellets out of the rail car and into a transport container (A. Fischer, Personal Communication, September 3, 2013). The rail ballast surface is not conducive to cleanups (the pellets cannot be swept or vacuumed up after a spill occurs). These spilled pellets accumulate over time and are washed out with runoff after rainfall events due to their buoyant properties. The U.S. plastics industry reports that rail transports 53% of total preproduction plastic pellets (ACC, 2013).

Preproduction plastic pellets ranked highest in abundance in a beach trash characterization study conducted on Orange County beaches in 1998 (Gordon, 2006). A study conducted on the Singapore coastline found microplastics in the sediments of



---

four out of seven beaches (Ng et al., 2006). The researchers suggested that the sources of these microplastics were likely waste disposal practices by industry, recreation, and ships (Ng et al., 2006). Even farther afield,

microplastics have been found in significant quantities in remote, non-urban regions of the Southwest Pacific (Derraik, 2002; Gregory, 1983; Hirai et al., 2011).

---

## STORM EVENTS

Storm events, such as hurricanes, tornadoes, floods and tsunamis can cause the accidental release of large volumes of plastic debris from land-based sources to the ocean (NOAA, 2008). One storm event in the Los Angeles region during 1997 released 13 metric tons of debris from Ballona Creek into the Santa Monica Bay (Stevenson, 2011). The baseline trash load allocation for the entire watershed was set by the Los Angeles Regional Water Quality Control Board at 290 metric tons per

year prior to implementation of maximum load allocations in 2002. Catchment basins were installed to collect trash before it could enter the Los Angeles River. This debris would have included sediment and vegetation, along with trash, but based on a trash characterization study conducted by the LARWQCB, it is likely that approximately 9% was trash – and somewhere between 50%-80% of the trash was composed of plastic (Noyes and Kubomoto, 2004).

---

## COMPOSITION

Plastic is a synthetic polymer formed from petrochemicals, such as oil and natural gas. While there are many types, the most common plastics are derived from hydrocarbon monomers. These hydrocarbon units, primarily carbon and hydrogen atoms, make up the backbone of the plastic fiber. Other elements such as chlorine, nitrogen, and oxygen can also be found within the molecular structure and add different properties to the plastic. Polymers are then formed from the monomers through a process called polymerization that links the units together into long chains. Although the non-hydrocarbon units create differentiate plastic types suitable for different uses, most commercial plastics share a variety of generic attributes, such as varying resistances

to chemicals and thermal and electrical insulation (ACC, n.d.). In addition, plastics are commonly mixed with additives, called plasticizers (such as colorants, matting agents, pacifiers, and luster additives), to obtain the desired results for a particular manufactured product (Andrady et al., 2009).

Plastics can be separated into two broad sub-categories: thermoset and thermoplastic. Once cooled, thermoset plastics do not return to a malleable state when reheated. The process of cooling these plastics alters the chemical structure of the polymer to the degree that it can no longer be remolded. Though less common, this type of plastic is intended for long-term uses because it is durable and strong. The second type is thermoplastics, which melt when introduced

to heat but solidify to the same chemical structure once cool (EPA, 2013). This category includes all of the following most common types of plastic: High Density Polyethylene (HDPE), Polypropylene (PP), Polyvinyl Chloride (PVC), Polystyrene (PS), and Polyethylene Terephthalate (PET/PETE).

Polyethylene, the most prevalent form of plastic used today, can be injected or blown; it is used to make plastic film, detergent bottles, milk jugs, water and chemical barrels, plastic grocery bags, food storage bags, cling wrap, and insulators in electrical cables (Plastics Europe, n.d.). Polypropylene, the second-most common form, can be molded, formed, and blown, and it is used in everything from window and door frames

and water and sewage pipes to containers, bottles, household goods (plates, bowls, appliances), and personal items (combs, toothbrushes, hair dryers) (Plastics Europe, n.d.). Other common plastic types include polyvinyl chloride, produced as a white powder that is then blended with other materials that are used in construction (Plastics Europe, n.d.). Polystyrene is used as an insulation medium for buildings, as well as for moldable packaging material used to protect a wide variety of consumer goods during transport and storage (Plastics Europe, n.d.). Polyethylene terephthalate has all but replaced glass bottling in Europe, with a world demand of 14.5 million tons in 2008 (Plastics Europe, n.d.). Table 1 below provides a brief description of each type and its uses.

TABLE 1. THERMOPLASTICS – DESCRIPTIONS AND USES

Thermoplastic Type	Description	Uses
HDPE	Typically translucent plastic; stiff; good barrier to gases and liquids; durable under stress and strain; good resistance to chemicals	Milk and juice containers; water bottles; film in trash bags and t-shirts; toys; trash cans; household cleaning products; food items with short shelf lives
PP	Strong resistance to chemicals; low density; high heat tolerance; easy to process	Packaging products; hot liquid beverage containers; flexible and stiff packaging; automotive products

Thermoplastic Type	Description	Uses
PVC	Strong physical properties; low heat resistance (does not combust or catch on fire easily, but has a low “softening” point); major benefit is that it can be made transparent	60% of PVC products utilize the rigid nature of the plastic; more pliable applications include construction materials (pipe, siding, windows); cable and wire insulation; synthetic leathers, medical tubing
PET/PETE	Clear and tough plastic; efficient at containing gases and moisture	Soft drink bottles; food containers; clothing; insulation; furniture; luggage; health care products
PS	Can be foamed or rigid; low melting point	Foam containers; packaging; insulation

Derived from reports prepared by Cal Recycle (CalRecycle, 2008).

To distinguish the types of plastics that are found in products, the Society of the Plastic Industry (SPI, the plastics industry trade association) developed resin identification codes (RIC) that correspond with different types of plastic. The purpose of this code is to make recycling plastic waste easier for consumers by being able to identify the type of plastic in an item and then determine whether or not it is recyclable. Not all plastics that are marked with these codes are recyclable, but codes exist to label the following types of plastic: PET, HDPE, Vinyl, LDPE, PP, PS, and Other. These codes have also found purpose in identifying which types of plastic are most commonly used (EPA, 2013).

Recycling plastic waste is one of the most fundamental ways of preventing plastic from entering landfills. The process of recycling plastic debris first requires the separation of

plastic debris into their different types. The more homogeneous a resin mixture is when recycling, the more predictable the resulting product will be. The RIC codes are helpful in this selection process. Once separated, the plastics are ground into smaller pieces and separated from other contaminating materials in flotation tanks. After drying, the flakes are melted and filtered to form preproduction pellets that can be formed into new items.

While the intentional destination of waste plastic is either the landfill or recycling plant, this is not always the case. Since the nature of plastic is to be a durable product, its existence in environmental settings is long-lived. The introduction of biodegradable plastics was a step towards finding a resin that breaks down in the environment. Typical thermoplastics have a chemical structure that is not conducive to biodegradation. The carbon

---

chains in the thermoplastics align end-to-end, which resists natural degradation or breaking of its chemical bonds by microorganisms (Zheng et al., 2005). However, they are susceptible to physical degradation through ultraviolet radiation and physical weathering, which makes them brittle. This produces smaller pieces of thermoplastic resins, but they are still unusable by organisms. Biodegradable plastics attempt to avoid the issues associated with traditional plastics by producing a resin that is specifically tailored to break down in the natural environment by organisms or chemicals. According to the SPI, a “degradable plastic” is one that is broken down by naturally occurring microorganisms (SPI, 2012). There are two types of biodegradable polymers (Sivan, 2011). The first are intrinsically biodegradable as they are broken down through enzymatic

reactions; the second are photo- and thermo-oxidizing polymers that break down as they react with light and heat to form oxygenated groups, which can be metabolized by microorganisms.

Compostable plastics are a different type of plastic resin that is often used interchangeably with biodegradable plastics. This type of plastic is made to be broken down, specifically in a composting environment. The SPI indicates that compostable plastic must break down into carbon dioxide, inorganic compounds, water, and biomass at a similar rate to other compostable materials and has no distinguishable toxic residue (SPI, 2012). This differs from the biodegradable criteria in that it has a temporal factor of breakdown, as well as limitations of toxicity.

---

## QUANTITY

The quantity of plastic that exists in the environment is dependent on the amount of plastic that is produced. With global quantities of produced plastic on the rise since its development in the early 1900s, there is no surprise that plastic trash in the environment is of growing concern. Plastic’s resilient nature allows it to be persistent for long periods of time without completely

decomposing but just getting smaller and smaller. The manufacture and sale of new plastic products maintains a steady stream of plastic debris that enters the environment, and while global efforts to reduce the impact of plastic debris have been increasing, they do not seem to be keeping up with the increase in production.

---

## PRODUCTION

Plastic production over the last 20 years has increased by an average of 5% per year, from 265 million tons produced in 2010 to about 280 million tons of plastic in 2012 (Plastics Europe, 2013; UNEP, n.d.). China was the

largest producer of plastic in 2012 and made up 23% of the global production. Other Asian countries, including Japan, accounted for another 20% (about 50 million tons) of the total. Europe produced an additional

---

estimated 50 million tons of plastic in 2012, as did the countries under the North American Free Trade Agreement (NAFTA), which includes Canada, Mexico and the U.S. The most commonly produced plastics in both the U.S. and Europe are HDPE and PP (Plastics Europe, 2013; ACC, 2013).

In the U.S. alone, 32 million tons of plastic were generated in 2011. Packaging was the largest component of plastic production, producing over 12 million tons of plastic. Consumer products were the second largest

category of plastic production, making up another 7 million tons (ACC, 2013, EPA, 2013). Other large users of plastic resins were the construction industry, transportation, and electronics. Large quantities (about 7 million tons) of plastics are also produced annually in the U.S. for exportation. Exports are shipped mainly to Mexico, Canada and Latin America and consist primarily of PVC, HDPE, and LLDPE. In 2012, the shipments of plastics were valued to be an \$87 billion industry and are expected to grow in coming years (ACC, 2013).

---

## WASTE

Plastic waste generation is centered in cities and urbanized areas and is the third largest constituent of the waste stream on a global scale, following only food and paper waste. Between 1980 and 2000, the percentage of the municipal waste stream that is plastic in the U.S. has more than doubled. It now makes up nearly 13% of the municipal waste stream (EPA, 2013). Trends of proportionally increased amounts of plastic waste in waste streams have also been recognized in other countries including Spain, Greece, France, and Japan (UNEP, n.d.).

The state of California's waste stream consisted of nearly 9% plastic in 2000, and contributed about 3.5 million tons of debris (CalRecycle, 2010). Of the most common types of plastic that were found in the waste stream, plastic films were the most abundant, followed by durable plastic items, plastic trash bags, and then industrial packaging films (CCG, 2004). A large portion of waste plastic was remainder and composite plastics that typically do not fit in any other categories and are often combined with other materials like metals. Given the lightweight nature of plastic, the material occupies nearly 20% of the state's waste stream by volume.

---

## RECYCLING

With such a rate of production of plastic debris, low recycling rates mean not only that more plastic is being deposited into landfills and is being released into the environment, but also that increasing amounts of resources are being put towards plastic production (Plastics Europe, 2013; EPA, 2013). According to Plastics Europe, in 2012, only 26% of

Europe's plastic waste was recycled (Plastics Europe, 2013). Contrarily, the U.S. only showed 8% recycling rates in 2011 (EPA, 2013), although the reported U.S. recycling rate does not include plastic that is found in automobiles that are recycled separately from plastic in the municipal waste stream.



---

Separating the U.S. plastic recycling into separate subcategories gives a more detailed view. Approximately 11% of films such as bags, sacks, and wraps were recycled in 2011. Recycling rates for PET and HDPE were 29% (EPA, 2013).

In total, recycling has not made a substantial reduction in the waste stream for plastics. Despite incentives for recycling plastic such as California's beverage container-recycling program, which places California Redemption Values on containers, only 5% of California's

plastic is recycled (CalRecycle, 2010). In California, the most recycled plastic is PET (RIC 1), and it is used to make items such as bottles, egg cartons, and fibers (CalRecycle, 2011). When observed by land-use types, plastic waste production differs. Residential areas produce 9.4% plastic waste and commercial areas produce 12% (CCG, 2004). Between what is produced, what is sent to landfills and what is recycled, the rest of the plastic debris ends up as litter and makes its way into the environment.

---

## ACCUMULATION IN THE MARINE ENVIRONMENT

---

The accumulation of plastic in the ocean often concentrates around specific regions where oceanic currents converge, bringing debris with them. Gyres, such as the North Atlantic Subtropical Gyre and the South Pacific

Subtropical Gyre, have been documented in many regions of the world's oceans and have become a focus of numerous marine studies to document the accumulation of floating plastic debris (NOAA, 2012).

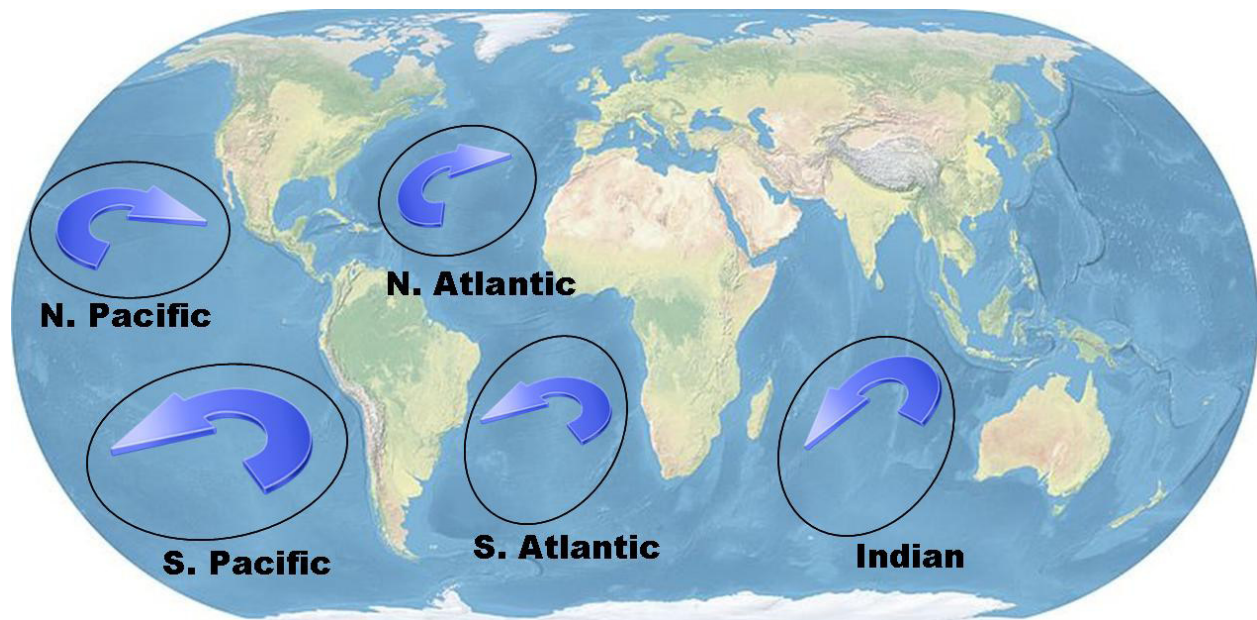

FIGURE 1: THE FIVE SUBTROPICAL GYRES AROUND THE WORLD.

According to NOAA, off the northeast coast of Hawaii there is a "semi-permanent, subtropical area of high pressure in the North

Pacific Ocean. It is strongest in the Northern Hemispheric summer and is displaced towards the equator during the winter when

---

the Aleutian Low becomes more dominant” (NOAA – Marine Debris Program). This North Pacific Subtropical Gyre is a region in the Pacific Ocean where four large clockwise rotating currents converge (Stevenson, 2011). Trash that has made its way to the ocean accumulates in this high-pressure zone. This collection of trash is commonly called the Great Pacific Garbage Patch. Although some reports have claimed that this giant collection of trash is a floating island of trash, it is actually composed of mostly small fragments of plastic and discarded fishing gear that is floating just below the surface. An examination of the gyre showed 75% of 113 drifting markers were contained within the gyre after 12 years (Stevenson, 2011). This demonstrates that the majority of items that enter the gyre are likely to remain there. The true size and mass of the trash in the gyre is unknown (NOAA, 2013).

The North Atlantic Subtropical Gyre is also an accumulation point for marine debris. Plastic marine debris from the Eastern Seaboard has been modeled to migrate to the interior of the North Atlantic Subtropical Gyre in less than 60 days (Law et al., 2010). The synthesis of 22 years of surveys to assess the density of plastic debris accumulating in the North Atlantic Subtropical Gyre yielded a maximum density of 580,000 pieces km<sup>-2</sup> (Law et al., 2010). A similar study conducted in the 1970s found that the amount of accumulated plastic debris was just 167,000 pieces km<sup>-2</sup> (Colton Jr. et al., 1974). One recent study indicated that 88% of the plastic debris found was smaller than 10 mm with a mean particle size nearly half the length of what was found in the 1990s, implying progressive degradation

of plastic in the marine environment (Moret-Ferguson et al., 2010).

Other regional studies have provided additional findings of plastic debris in subtropical gyres. A study of the South Pacific Subtropical Gyre utilized a 333- $\mu$ m trawl net, and samples were taken in 60-minute sweeps and categorized by size and type (Eriksen et al., 2013). The study found that 96% of the trawling expeditions yielded plastic debris, with an average density of 26,989 pieces km<sup>-2</sup> and an average weight of 70.96 g km<sup>-2</sup>. The most abundant size of plastic debris was between 1 and 4.75 mm, which constituted 55% of the count and 72% of the total weight. Studies in the South Atlantic Gyre have yielded findings of that saw between 1300 to 3600 pellets km<sup>-2</sup> using a 0.32 mm mesh, and one to three plastic items km<sup>-2</sup> through observations with binoculars (Morris, 1980; Barnes et al., 2005). In the Indian Ocean, the Bay of Bengal and the Straits of Malacca revealed 18,000 counts of debris, with 98% of them being plastic, over the 3,275 km of transects in a study by Ryan (2013). The re-accumulation of beach debris around the ocean revealed 50 to 200 pieces of plastic accumulating per kilometer, per day on the eastern shores, while other areas in the south had, on average, less than one piece of plastic (Barnes et al., 2005).

Over the past fifty years, the amount of plastic debris that has been recorded in many of these gyres has substantially increased up until the last decade. Currently, some regions of the ocean such as the Western North Atlantic show a stabilizing concentration of plastic debris, despite increasing amounts of plastic being produced in many countries

---

(Law et al., 2010). One speculation is that the rate of plastic entering oceanic gyres is now being matched by the rate that plastic is sinking from the surface. As plastic remains in the ocean and breaks down, it becomes more dense and thus more apt to disperse throughout the water column. This causes a perceived stabilization of plastic

concentration on the surface and more plastic debris settling into sediments (Barnes et al., 2009; Moret-Ferguson et al., 2010; Allsopp et al., 2006). While this stabilizing trend is being noticed in the Northern Hemisphere, one study in the Southern Hemisphere reported an increasing amount of plastic debris in these gyres (Barnes et al., 2009).

## IMPACTS

---

The presence of plastics in the environment can have many consequences, some of which are now well known, and others that are still under investigation. As plastic debris continues to litter beaches and circulate in the ocean, its presence and damaging effects on biological, ecological, and economic systems are becoming apparent. The condition of our ocean is linked to the land-based behaviors of humans. Due to an abundance of single-use, disposable plastic products, the lack of plastics recycling, industrial and transport

spills, and littering, there are now five gyres of plastic floating in the ocean, beaches littered with plastic debris, and animal deaths linked to plastic consumption or entanglement (Barnes et al., 2009; Bugoni et al., 2001; Derraik, 2002; Freinkel, 2011; Furness, 1983; Gregory, 2009; Ryan, 2008; Thompson et al., 2009; Van Franeker, 1985). In the following section, we examine the effects of plastic debris in river, beach, and ocean systems, as well as on human bodies, and as an economic cost.

## RIVER POLLUTION

---

In urban regions, the boundaries between rivers and residential or industrial sectors have greatly diminished. Rivers that were once naturally formed from the movement of boulders and sediment deposits have been reshaped by humans and are now restricted by concrete channels. . Most rivers in urban areas no longer meander, periodically flood, and support complex ecosystems of birds, fish, and mammals, but instead are used solely for the movement of water and to aid in flood protection. Most of the water in these urban rivers now comes from stormwater runoff and wastewater and industrial effluent.

This is the case for much of the Los Angeles and San Gabriel rivers.

Waste generated from humans, if poorly managed and lying on the sides of roads, can be washed into storm drains with precipitation. Entrances to storm drains may have grates that prevent large pieces of debris from entering. However, in many locations, there are no storm drain coverings – allowing large materials to be swept inside. While some cities have installed secondary sorting technologies that may prevent waste flow to the ocean, most trash flows unrestricted once it enters a drain. Debris can find its

---

way to the ocean through small tributaries that lead to larger rivers, and eventually to highly sensitive zones (such as estuaries), and finally the coast. Stormwater may bypass this system and be piped directly to the ocean.

If industrial facilities are near rivers, their discharge may flow directly into waterways. If these facilities store or manufacture plastic products, their mismanagement may lead to river pollution.

## BEACHES

---

Globally, beaches have been affected by trash accumulation. Visitors who do not properly dispose of waste, rivers with outlets nearby, and ocean currents, are all sources of trash to beaches. This litter has been linked to a loss of tourism, which economically harms local businesses, such as restaurants, fishing communities, and tourist shops, and decreases property value.

California's unique coastal landscapes include sandy beaches, steep cliffs, estuaries and large ports. This variety of coastal and California's location on the eastern pacific have enabled the state to become the fifth largest industrial economy in 2000 (NOEP, 2005). In 2000, 77% of California's population lived in or near the coast, with the fastest growing population in nearshore communities (NOEP, 2005). It has been estimated that the ocean-based economy in California is worth \$64 billion (NOEP, 2005).

Reduction or degradation of this asset can have a large economic impact on the state.

The importance of clean beaches can be seen in the number of organizations and participants that come together for beach cleanups. During the past 20 years the Ocean Conservancy has helped to organize over 6 million volunteers from 100 countries to remove over 100 million pounds of trash from 170,000 miles of beach and inland regions (Moore, 2008; OC, 2011). While beach cleanup efforts are helpful for removing large anthropogenic debris and educating the public, people are only capable of removing items they can easily see. Smaller preproduction plastic pellets and other types of microplastics are difficult to detect and remove manually, and so these have been largely missed. However, they are also less likely to degrade the aesthetics of the beach environment as larger pieces.

## OCEANS

---

*"The very survival of the human species depends upon the maintenance of an ocean clean and alive, spreading all around the world. The ocean is our planet's life belt."*

~ Jacques-Yves Cousteau  
(1980)

Plastic waste is often lightweight, non-biodegradable, and can either float or sink depending on its composition. The very properties that make plastics convenient to humans are what make it such a threat to the ocean. Versatility, durability, and long lifespan allow plastics to impact nearly every marine ecosystem. Once plastics reach the ocean

---

they are easily carried to other locations by ocean currents where they can become deposited on beaches or trapped in gyres where they may remain for hundreds of years depending on their chemical composition (Andrady, 1988; Freinkel, 2011; Kershaw et al., 2011; Law et al., 2010; Shaw et al., 1994).

Durable debris, such as plastics of all sizes, will follow currents to gyres. Gradually, through wave action, photo-degradation,

oxidation, and hydrolysis, the large pieces of plastic will break down into smaller microparticles. These smaller pieces present a new host of issues, including adverse effects on marine life that are difficult to quantify. Once in the ocean, plastics have been found ingested by marine species, entangled around biota, assisting in the spread of invasive species, leaching harmful chemicals to the environment, and building up on the marine floor.

## BIOTIC CONSUMPTION

---

Based on the variability of plastics' buoyancy, it is suspected that animals forage on plastics both the benthic (bottom of a water body) and the pelagic (water column) zones. Thus, nearly all species can be affected by its presence. While no peer-reviewed studies have conclusively shown that plastic ingestion has resulted in marine species mortality, a variety of studies have documented numerous species of turtles, fish, mammals, birds, and invertebrates that have ingested plastics (Allsopp et al., 2006; Auman et al., 2004; Baird et al., 2000; Barnes et al., 2009; Blight et al., 1997; Boerger et al., 2010; Bond et al., 2013; Bourne et al., 1982; Browne et al., 2008; Bugoni et al., 2001; Buxton et al., 2013; Campani et al., 2013; Carr, 1987; Carson et al., 2013; Colabuono et al., 2009; Connors et al., 1982; Eriksson et al., 2003; Graham et al., 2009; Gregory, 2009; Ivar do Sul et al., 2013; Jacobsen et al., 2010; Kershaw et al., 2011; Laist, 1987; Moser et al., 1992; Murray et al., 2011; Petry et al., 2009; Provencher et al., 2010; Robards et al., 1995; Rodriguez et al., 2013; Ryan, 2008; Sazima et al., 2002; Schulyer et al., 2013; Stamper et al., 2006;

Stevenson, 2011; Teuten et al., 2007; Tourhino et al., 2010; Van Franeker, 1988). Appendix D details this research and subsequent findings.

Species that rely heavily on ocean currents, both for movement (often for transportation in the larval stage) and foraging may be particularly susceptible to the plastics accumulating in the oceans' gyres. Sea turtles, which often reside under debris as a form of shelter, are particularly at risk of both entanglement and consumption (Carr, 1987). Albatross, which follow oceanographic currents for foraging, have been found to ingest small plastic pieces (that may also be traveling with ocean currents) and feed them to their chicks; leading scientists to associate increased infant mortality with plastic consumption (Colabuono et al., 2009).

Surface and plankton feeders appear to be at greater risk of ingestions due to the buoyancy of many plastics. In a study in the subarctic waters of Alaska for example, most of the carcasses found with plastics in their guts were surface feeders (shearwaters, petrels, gulls) or plankton feeding divers (auklets,



---

puffins) (Derraik, 2002). Of the 4,417 plastic particles that were examined, 76% were industrial pellets and 21% were broken down pieces of larger plastics (Robards et al., 1995). In comparison to a similar study conducted 10 to 15 years earlier, significantly more plastics were found to be ingested, indicating that as plastic use and production continues to rise, so does its rate of consumption (Robards et al., 1995).

Another study in the North Pacific in 1997 examined the stomachs of birds caught as bycatch, and found plastics in eight of the 11 species caught (Blight et al., 1997). According to researcher David Laist (1987), at least 267 species are affected by plastics in the ocean. Tomas et al. (2002) found that 78% of the 54 loggerhead turtles captured by fishermen had

plastics in their digestive tracts. Much of the plastics found in their stomachs were plastic bags that are thought to have been mistaken for jellyfish by the turtles (Bugoni et al., 2001).

While there is an abundance of peer-reviewed literature on biotic consumption, the issue of marine ingestion may be underestimated due to the possibility of plastic transfer up the food chain as predators consume smaller prey species. Additionally, while the cause of death is often suspected to be plastic-related, it has never been conclusively shown (Baird et al, 2000; Wolfe, 1987). For example, while at least 26 cetaceans were found with plastic debris in their stomachs, the researchers were not able to prove that plastics were the cause of death (Baird et al., 2000).

---

## ENTANGLEMENT

One of the main causes of animal entanglement comes from derelict fishing gear. This entanglement from abandoned and floating nets is called ghost fishing. Fishing gear has been found wrapped around the bodies of mammals causing species to drown. Discarded fishing gear has also been found cutting through the skin of various species, causing deep lacerations and infections, limiting foraging ability, and reducing predator avoidance (Barnes et al., 2009; Gregory, 2009; Derraik, 2002; Laist,

1987; Stevenson, 2011). Other deadly plastics found in the ocean are bags, balloons, caps, straws, six-pack rings, and other fragments of plastics (OC, 2010). These materials have been found around the necks and in stomachs of animals, slowly choking them as they grow and blocking food passage. Carr, 1987; Gregory, 2009; Jacobsen et al., 2010; Kershaw et al., 2011; Rodriguez et al., 2013; Stevenson, 2011; UNEP, 2006; Waluda et al., 2013). For additional research information see Appendix D.

---

## BENTHIC LIFE

It is not just plastics floating in the water column that are of concern; plastic debris on the seafloor may be associated with impacts as well (Gregory, 2009). While most plastics

are buoyant, a study in Tokyo Bay found that 80%-85% of the seabed debris was plastic (Derraik, 2002). Plastic debris on the seabed can prevent crucial processes, such as gas

---

exchange between water and the sea floor, resulting in hypoxia and reduction in other essential ecosystem functions (Goldberg, 1997). This change in benthic ecology has the potential to alter the number of species

that are able to reside in the habitat. Additionally, plastic on the sea floor opens up the possibility of accidental consumption of plastic to species that reside in this region (Goldberg, 1997).

## TRANSPORT MECHANISMS – SPREAD OF INVASIVE SPECIES

While species have been introduced to new regions (invasive species) via ballast water from boats, or on natural items such as driftwood, the long lifespan of plastic marine debris could create a new vector for invasive species travel (Allsopp et al., 2006; Barnes, 2002; Hinojosa et al., 2011; Kershaw et al., 2011). Species such as bryozoans, barnacles, polychaete worms, hydroids, coralline algae, and mollusks are particularly susceptible to attaching to plastic debris and then being transported to new regions as the plastic travels via currents (Allsopp et al., 2006; Barnes, 2002; Barnes, 2005; Gregory, 2009). For more detailed information on research see Appendix E.

The long life span and range of porosities found in plastics also poses transportation threats to microbes. A diverse range of microbes have been found to “hitchhike” on them – using the plastic for transportation, making them a type of artificial plastic reef (Allsopp et al., 2006; Barnes, 2002). While studies of the effects of marine debris on animals are relatively common, studies on the microscopic level are just beginning to emerge. Microplastics have the ability to travel vast distances and remain intact much longer than other natural materials,

such as feathers, wood, and macroalgae. Due to these characteristics, scientists are discovering that they may be a vector for microbial invasive species. Zettler et al. (2013) found small pores in plastic marine debris harboring microbial communities that were not found naturally in the regions they were collected. The hydrophobic nature of plastics makes them a good environment for colonization and subsequent growth of microbes. This collection of microbial heterotrophs, autotrophs, predators, and symbionts are now referred to as the “plastisphere,” which may facilitate transportation beyond normal ranges and may even allow for the spread of dangerous diseases or pathogens (Zettler et al., 2013).

An interesting aspect to this plastisphere is that species of hydrocarbon-degrading bacteria have been found residing in pores that closely resemble their size and shape. While more research needs to be conducted, species that are often found in hydrocarbon and diesel-contaminated soils, as well as oil spills, have been found in these pores, indicating that they may be consuming part of the plastic surface (Zettler et al., 2013).

---

## DEGRADATION AND CHEMICAL LEACHING

---

The wide varieties of plastics in use today are made with different polymers and endless varieties of plasticizers and chemicals. In certain environments, chemicals have been known to leach out of the plastics that were once containing them, freeing chemicals such as endocrine disruptors and carcinogens to the environment (EC, 2013; Saido et al., 2009). In contrast, as plastics degrade they may become more likely to adhere to contaminants floating in the ocean, transporting the toxins up the food chain. Depending on whether or not these chemicals are in salt water (the ocean), fresh water (river and tributaries), or lipid rich systems (in an animal's body for instance) different processes may be triggered.

Under certain circumstances, the polymer molecules that compose plastic materials can become cross-linked; making the plastic more brittle and allowing for easier fragmentation (Shaw et al., 1994). With fragmentation, harmful chemicals such as Persistent Organic Pollutants (POPs) can leach into waterways, where they persist without degradation for long periods of time. (Mato et al., 2001; EC, 2013; Wargo et al., 2008).

It is not just the raw materials in plastics from manufacturing that are of concern. The physical characteristic of plastics (hydrophobic and low polarity) and a high porosity attracts toxins (Hirai et al., 2011; Mato et al., 2001). Therefore, plastics may be collecting and transporting many types of toxins: persistent organic pollutants (POPs), polychlorinated biphenyls (PCBs), polycyclic aromatic hydrocarbons (PAHs),

dichlorodiphenyl trichloroethane (DDTs), and other organic pesticides (Fisner et al., 2013; Teuten et al., 2009; Rios et al., 2007; Mato et al., 2001). Even if plastics are inert at production, as the degradation process occurs, the physical and chemical properties of the compound become altered, at times increasing their affinity to bind to other chemical compounds (Bakir et al., 2012; Frias et al., 2011; Stevenson, 2011). If chemicals such as DDT are floating in the marine environment they may become adsorbed (attach) to plastic fragments. Once on plastics pieces, more toxins may be transported up the food chain, from the species that consume them (Carson et al., 2013). While some of the adverse effects of toxins from plastics are known, their fate and dispersion within the ocean remains somewhat elusive (Rios et al., 2007). Some fear that due to the foraging behavior of marine invertebrates and the threat of bioaccumulation, more adverse effects of plastic leaching are yet to be discovered (Zitko, 1993).

Most studies investigating leaching from plastics have taken place on land and in systems that would affect humans, but entirely different processes may occur in other environments. For instance, conditions such as prolonged sunlight exposure, cloud cover, and microorganism abundance affect the rate at which degradation and leaching occur. Additionally, plastic composition affects the degradation process. Depending on the intended use, additives may decrease or increase the rate of photodegradation. For instance, plasticizers are often used for structural support, but may promote leaching

---

and thus accelerate plastic breakdown (Shaw et al., 1994; Andrady et al., 2009). On beaches, dyes used in the plastics can also have the effect of speeding up breakdown (darker colors absorb more light) leading to accelerated decomposition (Shaw et al.,

1994). The longer plastics remain in the marine environment, the more likely they are to bind with other pollutants, indicating that older plastic debris may be more dangerous (Kalliopi et al., 2012). For more research information see Appendix F.

## HUMAN HEALTH

---

It was not long ago that plastics were thought to be completely safe for both humans and the environment. The first study to show dangers of plastics was published in 1969. Two toxicologists at John Hopkins University discovered that after rats received blood transfusions containing plastic particles, phthalate ester plasticizers were found in their blood (Jaeger et al., 1970). What was once thought of as a safe material for humans was not as inert as expected. After this discovery, scientists became more interested in looking at how the materials in plastics interact with the environment.

Bisphenol A (BPA) is used as an epoxy resin to line canned foods and drinks, and is also a primary component of polycarbonate, a clear hard plastic, often used to make bottles and eyeglass lenses (Wargo et al., 2008). BPA acts as a weak estrogen (Artham et al., 2009). It can bind to estrogen receptors on cells and block naturally occurring estrogen from binding and can alter the body's natural production of estrogen (Artham et al., 2009; Freinkel, 2011; Wargo et al., 2008). Hot water, detergents, and seawater can loosen the polymer chain in these plastics allowing small amounts of BPA to become freed from the material (Artham et al., 2009). This chemical may then bind to human tissue or be washed out with wastewater systems. While

it is known that BPA can leach from plastic materials and has been found in human blood samples, research still needs to examine how severe the effects of BPA may be (Kershaw et al., 2011; Wargo et al., 2008).

Not all biphenyls (plasticizers of polyethylene the raw material of polycarbonate) are still allowed in products within the U.S (Saido et al., 2009). One example, polychlorinated biphenyl (PCBs), a now illegal but once commonly used plasticizer, has become much more common in marine food webs. Even after phasing this chemical out of products, older discarded plastics containing PCBs can still be found floating in the ocean. High concentrations of PCBs can lead to metabolic problems, reproductive disorders, increased risk of disease, and death, but its effects in marine systems are not yet fully understood (Mato et al., 2001).

Phthalates are commonly used to make plastics soft and pliable. One of these phthalates Di (2-ethylhexyl) phthalate (DEHP) has also been the subject of much concern. Unlike BPA, which mimics estrogen, DEHP is an androgen; it mimics testosterone and other masculine hormones (Wargo et al., 2008). It can be found in shower curtains, raingear, upholstery, dashboards, children's toys, as well as intravenous bags and tubing.

---

Over time, phthalates degrade and are released into the air, making them easy to enter bodies via inhalation, ingestion, or adsorption (Freinkel, 2011; NPR Interview with Mark Shapiro, June 17, 2011). Once these chemicals are in the body they are able to break down into smaller pieces called metabolites. These pieces are small enough to get into cells within the pituitary gland causing hormonal disturbances, which

some suspect may be partially responsible for increased rates of cancer, reproductive issues in women, and lower sperm count in males (Kershaw et al., 2011; NPR interview with Mark Shapiro, June 17, 2011; Wargo et al., 2008). While still allowed in the U.S., these products have been deemed dangerous enough that the European Union has outlawed them (Wargo et al., 2008).

## ECONOMIC COSTS OF LITTER

While most developed nations have recycling programs and some even have composting facilities, a proportion of their entire waste stream still ends up on roadways, in rivers, and in lakes. Unless this debris is collected, it eventually washes out to the sea. The economic impacts associated with litter are significant. California's tourism and recreational economy has been estimated at \$43 billion annually (NOEP, 2005). Economic impacts due to plastic litter and a decrease in the aesthetic value of beaches and shorelines are significant. For example, an accidental trash spill in New York in 1997 that affected New Jersey beaches resulted in an estimated \$1 billion in lost tourism revenues over a two-year period (COPC, 2008).

In California, municipalities currently expend approximately \$428 million annually related to waterway and beach cleanups, street

sweeping, stormwater capture devices, storm drain cleaning and maintenance, manual litter cleanup, and public anti-littering campaigns (NRDC, n.d.). Caltrans estimates that it spends \$52 million annually to cleanup litter from roads and highways (CDOT, 2013). The County of Los Angeles, Department of Public Works, estimates that it spends \$18 million annually for street sweeping, catch-basin maintenance, litter prevention, and educational outreach efforts (COPC, 2008). Beach cleaning efforts conducted by the County of Los Angeles cost an additional \$4 million per year to clean 31 miles of beaches, collecting more than 4,000 tons of trash (COPC, 2008). By 2008, Southern California cities had spent \$1.7 billion to comply with trash Total Maximum Daily Loads (TMDLs) (COPC, 2008).



# THE WATERSHEDS

## LOS ANGELES RIVER WATERSHED

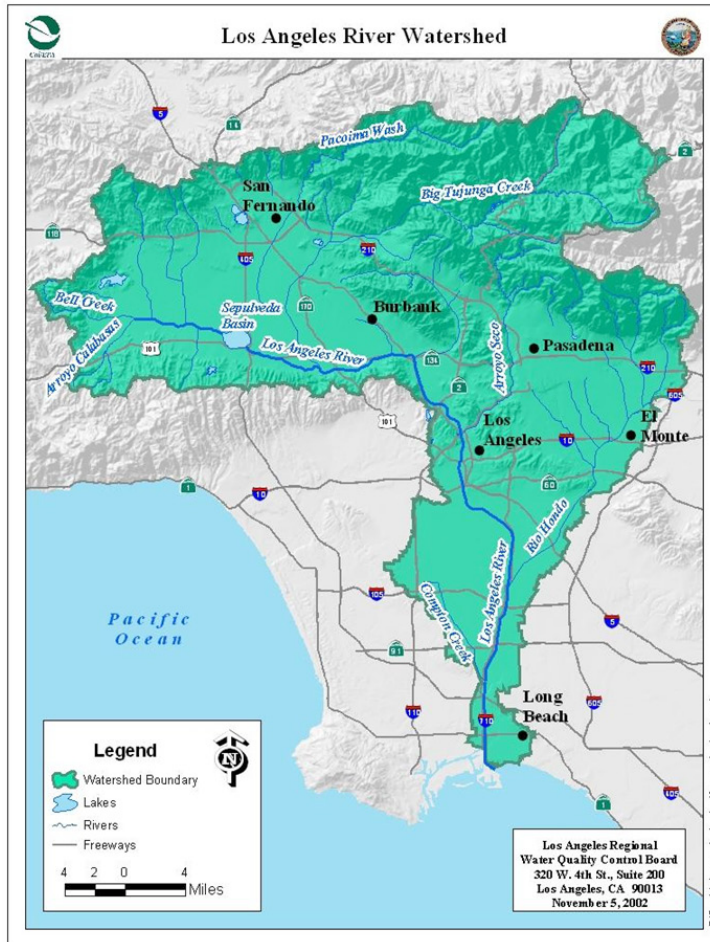

FIGURE 2: LOS ANGELES RIVER WATERSHED, TRIBUTARIES, AND MAJOR CITIES (LARWQCB<sup>2</sup>, 2002)

Before the Spaniards first set foot in what is now called the Los Angeles Basin, the Los Angeles River ("LA River") and its tributaries helped provide for the livelihood of an abundant ecosystem and for the local Native Americans (Gumprecht, 1999). The lush, fertile soils were consistently replenished by the often-flooded watershed, and the

year-round flow near the location of present-day downtown Los Angeles led to the first European settlements in the area. The view is much different nearly 250 years later, as the Los Angeles River Watershed ("LA River Watershed") is one of the most urbanized in the world. The LA River is now used mostly as an outlet for wastewater treatment plant discharges and stormwater runoff.

The LA River Watershed covers 824 square miles (CRWQCB<sup>2</sup>, 2007). The headwaters for the LA River begin in the Santa Monica, Santa Susana, and San Gabriel Mountains. The mainstem of the river is 55 miles long. Although some of the headwaters are still in their natural state, nearly the entire river flows in a concrete channel through heavily developed areas until it empties

into the ocean. Many of the lower tributaries, such as Compton Creek, Arroyo Seco, and Rio Hondo, are also channelized. The river's bottom and banks were covered by concrete beginning in the 1930s because the river's floods were severe, and development had encroached well within the safe limits of the floodplain (Gumprecht, 1999).

The LA River Watershed is in a Mediterranean climate. This is characterized by about 340 dry days a year and 25 wet days (City of LA,

---

2006). The typical dry season is from June to October, and the wet season is from November through May. During the wet season, intense storms can swell the LA River as the stormwater is quickly funneled off the surrounding mountains and city streets into the concrete channel. Historically, most of the flow in the LA River would dry up towards the end of the dry season. Today the LA River flows year-round, with about 65% of the dry-season flow from two tertiary-treated wastewater treatment plant discharges, the Donald C. Tillman Water Reclamation Plant and the Los Angeles-Glendale Reclamation Plant (Gumprecht, 1999). The Tillman plant provides a minimum discharge of 20 million gallons per day (MGD) and the Los Angeles-Glendale plant discharges about 15 million gallons per day (Headworks, Inc., 2012; City of LA, 2001). Another 30% of the dry-season flow comes from urban runoff through the storm drains. The remaining 5% of the flow is from groundwater.

The urban density that surrounds the LA River helps to increase runoff that contains trash. This runoff may be stormwater from the intense winter storms or from general water use during the dry-season, such as landscaping, street cleaning, and car washing. Given that there are 340 dry days a year in

the region, the typical runoff during most of the year is from general water use. Both types of runoff can pick up trash that has been collecting on city streets and transport it to the LA River through storm drains. The large winter storms are likely to transport trash in much greater quantities (Moore et al., n.d.; LARWQCB<sup>2</sup>, 2007). Trash can also be transported to the river via wind action and people dumping trash directly into the river.

Plastics represent a significant portion of the total trash. The Friends of the Los Angeles River volunteer cleanups in the Glendale Narrows portion of the LA River have reported volumes of plastic in the trash from 47% to 57% (Tyack, 2011). Caltrans conducted a trash study along freeway catch basins in the Los Angeles region and found plastics to be 33% of the trash by weight (Lippner et al., 2001). Of the plastic debris in the LA River, many pieces are smaller than 5 mm. A 2004 to 2005 study of plastic debris in the LA and SG Rivers found that plastic particles less than 5 mm were much more abundant than those greater than 5 mm (Moore et al., 2011). Policy efforts to address plastic debris inputs to the LA River with current legislation are described in the Policy section.

## SAN GABRIEL RIVER WATERSHED

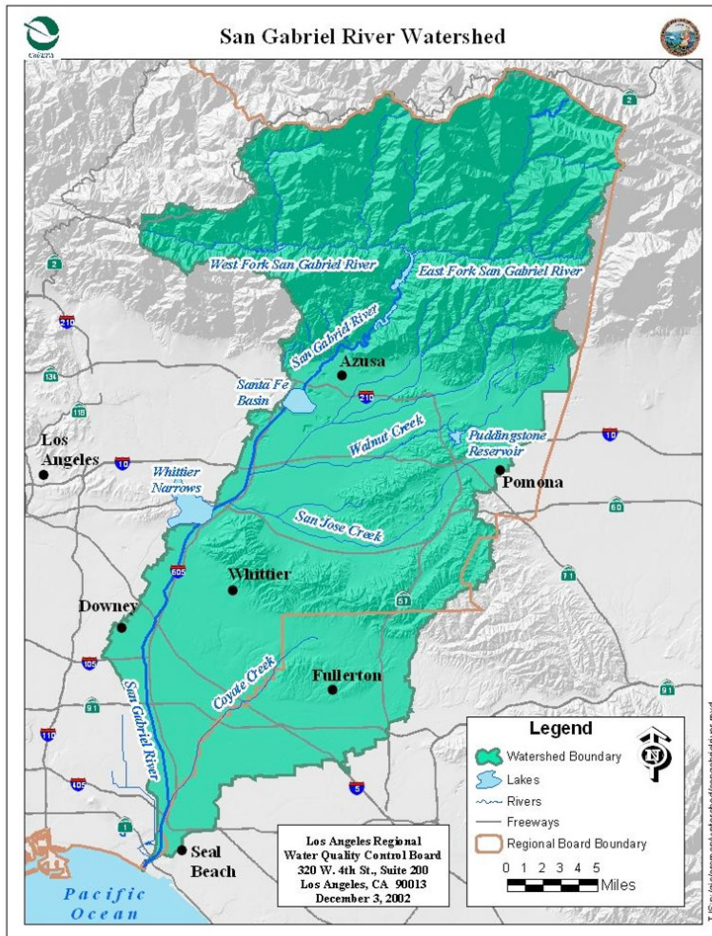

FIGURE 3: SAN GABRIEL RIVER WATERSHED, TRIBUTARIES, AND MAJOR CITIES (LARWQCB<sup>2</sup>, 2002)

The San Gabriel River Watershed ("SG River Watershed") covers approximately 689 square miles and occupies a large portion of eastern Los Angeles County, as well as a section of northwestern Orange County. It shares most of its western boundary with the adjacent LA River Watershed. Historically, the watershed was home to the Gabrieleno Indians, whose existence in the area relied heavily on the supply of water from the watershed. While they lived a relatively mobile lifestyle, the waterways played an

essential role in their migration. With the coming of Spanish settlers came the establishment of permanent settlements. Due to the flooding nature of the river, the local mission had to be moved on several occasions. When the mission was finally relocated to the stream's upper reaches, the settlers established small agricultural villages for sustenance in the area along the San Gabriel River ("SG River"). Following the separation of Mexico from Spain, the Mexican-American War brought about a new lifestyle to the area and more large ranches appeared.

With the discovery of gold in the mid-1800s, an influx of miners boomed the cattle trade but it was short-lived. The cattle market crashed as water resources were re-focused on the California citrus

industry. The growth of the citrus industry was assisted by the installation of the Southern Pacific Railroad. Throughout the 1900s flooding events incited the creation of dams to store water, along with the paving of sections of the river (Stein et al., 2007).

The headwater streams of the SG River Watershed originate in the San Gabriel Mountains. In this area, the streams maintain primarily native riparian habitat, with the exception of some areas that are set aside for recreational use (SWRCB, 2011). Due to its location near the coast and the orographic

---

effect as storms approach the San Gabriel Mountains, the SG River Watershed receives some of the heaviest rainfall in Southern California, with an average annual rainfall of 37.8 inches. This drains into the watershed's main channel, the SG River.

Due to its geologic makeup the SG River has high sediment yields and can generate voluminous debris flows after rain events (Stein et al., 2007). To cope with this, a series of four dams were built to control the flow of water and sediment. Below the dams, the SG River runs through a network of spreading grounds that are used to recharge groundwater. The main tributary from the west is the Rio Hondo. The SG River is fed from the east by Walnut Creek in the northern reaches, San Jose Creek in the middle reaches, and Coyote Creek in the southern reaches. A majority of the upper region of the SG River has a natural riverbed, but this is transformed into a cemented channel in the lower watershed where there is a higher population density.

Most of the undisturbed land is predominantly in the upper SG River Watershed, whereas most of the industrial and urban uses are found in the lower end of the watershed. In this region, the SG River has been transformed into a trapezoidal concrete channel. The majority of land use is high-density residential. The next major land use is industrial. According to a survey done in 2005 by Weston Solutions Inc., approximately 18% of the watershed is reserved for commercial, industrial, and transportation land uses, while 30% is used for residential purposes.

The major National Pollutant Discharge Elimination System (NPDES) permitted facilities in the San Gabriel River Watershed include publicly owned treatment works (POTW) and private industry. The POTWs discharge over 150 MGD (Ackerman et al., 2007) while the private industry facilities discharge an average of 0.1 MGD (CRWQCB1, 2007). Of the 74 NPDES permit-holding facilities, 38 of them discharge into the San Gabriel River; 24 discharge into Coyote Creek, and 12 into San Jose Creek. As of 2011, there were 570 registered dischargers along the SG River Watershed with general industrial stormwater permits that were concentrated in the cities of Irwindale, Pomona, Industry, and Santa Fe Springs. The most common industries registered as dischargers are trucking and warehousing, chemicals, metal production, and rubber and plastic production plants. There were an additional 446 construction sites with NPDES permits in the region as of 2011 (SWRCB, 2011).

Compared to the LA River Watershed, the SG River Watershed has less data on the volumes of trash and the percentage of plastic in that trash. Moore et al. (2011) conducted the sole study in this river to assess the amount of plastic debris. They sampled in two localities and found 411 pieces of plastic smaller than 4.75 mm per cubic meter. Pieces of plastic larger than 4.75 mm had a concentration of 125 pieces per m<sup>3</sup>. Though these data are limited (the sample size was small), they do serve as a preliminary characterization of plastic debris in the mainstem channel.



---

## POLICY

---

While disposing of trash at sea was once thought to be an acceptable practice, global, federal, state, and local agencies, as well as the plastics industry, have all acknowledged that marine debris poses a substantial threat

to ecosystems and to human health. A variety of legislation has been implemented to reduce the quantity of debris entering the ocean and make those responsible for the debris liable for cleanup and mitigation.

### GLOBAL

---

Over the past 40 years, there has been more focus on garbage reduction in global policy; however, legislation focusing specifically on plastics has been somewhat ineffective. Current policy aims at reducing trash discharges from ships into the ocean, but its effectiveness has been questioned due to the difficulty of enforcing pollution laws in international waters (Ellis, 1998; Kirkley et al., 1997). Additionally, there have been no comprehensive global land-based trash policies implemented to date.

In 1972, the International Convention on the Prevention of Marine Pollution by Dumping of Wastes and Other Matter (MARPOL), also known as the London Dumping Convention, was convened to come up with a plan to end all hazardous dumping. The result of these efforts was the enactment of the MARPOL Treaty of 1973, which aimed to reduce the amount of pollution from ships, including oil spills, air pollution, and garbage disposal. This included hazardous materials from ocean vessels, such as industrial waste, tank washing effluents, and trash. Annex V of this convention is an optional part of the treaty that focuses specifically on garbage and plastics. In late December of 1987, the U.S. Senate became the 31st country to accept the conditions of Annex V (Ellis, 1998). This treaty

imposes a complete ban on plastics (and other types of trash) entering the ocean via garbage disposal from ships (synthetic ropes, nets, and plastic garbage bags) within a certain distance from the shore (Conner et al., 1988; Ellis, 1998; IMO, n.d.). The Coast Guard enforces the bill in coastal U.S. waters, with a fine of up to \$25,000 for non-compliance (Conner et al., 1988).

An early study on the effectiveness of Annex V found that trawl waste was reduced on beaches in Alaska since the ratification of the law (Johnson, 1994). Other studies, however, have not found a decrease in accumulation of debris or in marine impacts, bringing to question its effectiveness (Santos et al., 2005). There is difficulty in enforcing MARPOL due to the nature of international maritime shipping. If a ship is thought to be in violation but is outside of the jurisdiction of the U.S., or the jurisdiction cannot be determined, a complicated bureaucratic process must be initiated between the Coast Guard, the State Department, and the Flag States. This has led to a poor response rate (Copeland, 2008). Due to this lack of enforcement and the fact that it is cheaper to discharge garbage and plastics into the ocean even when accounting for the risk of fines, many ships are not believed to be following the law (Kirkley et al., 1997).



---

Without streamlined procedures for dealing with violators, a large increase in resources for enforcement, and lowered use of plastics aboard ships, substantial ocean discharges of plastics will continue to occur. The law

that implements this treaty in the U.S. is the Marine Protection Research and Sanctuaries Act (MPRSA) (Cunningham et al., 2008). MPRSA is discussed further in the Federal section.

## FEDERAL

---

The first attempt to control ocean waste in the U.S. came in the form of the 1899 Refuse Act (33 U.S.C 407), which prohibited the release of any waste other than that of waste in liquid form (Kite-Powell, 1998). Later, both the Federal Water Pollution Control Act (Clean Water Act) and the MPRSA developed laws that pertained to the dumping of plastics at sea (Conner et al., 1988). A few other pieces of legislation deal with oceanic issues and play a role in pollution regulation.

The Clean Water Act's predecessor, the Federal Water Pollution Control Act (Amendments of 1948), was designed to bring together agencies to come up with ways to reduce the amount of pollution entering waterways. This act set standards for water quality by establishing uniform controls for each category of major pollution. The Federal Water Pollution Control Act Amendments of 1972, commonly referred to as the Clean Water Act, broadened the scope of regulation to include a wider range of pollutants and ensure "fishable and swimmable water" for all surface waters in the U.S.

Under the Clean Water Act, the federal government takes the position that discharging into waterways is a privilege, not a right. Section 402 of the Clean Water Act established the National Pollutant Discharge Elimination System (NPDES) and gave EPA

the authority to issue federal discharge permits (CWA, 1972). In California, the NPDES permit program is administered at the state level, and will be discussed further in the California section (EPA, 2009).

The MPRSA, commonly referred to as the Ocean Dumping Act, was enacted by Congress in 1972 (EPA, 2013). This law required regulation of all ocean dumping and mandated the creation of marine sanctuary regions where dumping is prohibited. The MPRSA encompasses the U.S. implementation of policies decided upon at the London Dumping Convention (LDC) (EPA, 2013). The legislation that came out of the LDC was similar enough to that of MPRSA that national adoption of the act only required minor provisions, which were in the form of more explicitly defined regulations (Cunningham et al., 2008; Wastler, 1981).

The MPRSA includes sections on prevention and removal of marine debris in order to prevent negative impacts on both marine life and navigational safety. This section also includes provisions for marine debris mapping, impact assessments, and removal efforts that are focused on areas identified as possible major threats. In addition, MPRSA states that research and development of gear that poses less of a threat to the marine environment should be conducted. It states

---

that outreach and education efforts should be made in order to educate stakeholders, the

fishing industry, and fishing gear, as well as plastic manufactures.

## CALIFORNIA

---

California has historically been a leader in environmental policy and the state has implemented various methods to regulate plastic debris. The federal Clean Water Act, the Porter-Cologne Act, NPDES permits, Total Maximum Daily Loads (TMDLs), and other state legislation such as AB 258 are the main examples of ways that California regulates plastic debris.

California's enforcement abilities start with the Porter-Cologne Water Quality Control Act ("Porter-Cologne"), one of the first and most comprehensive water quality laws in the nation, and the Clean Water Act. The California State Legislature enacted the Porter-Cologne in 1969. This act gave power to the California State Water Resources

Control Board ("State Water Board") and nine Regional Water Quality Control Boards ("Regional Water Boards"), which includes the Los Angeles Regional Water Quality Control Board (LARWQCB) and the Santa Ana Regional Water Quality Control Board, to regulate and preserve the beneficial use of the state's waters. Many sections of Porter-Cologne were used in designing the Clean Water Act (CEPA, 2009). Porter-Cologne, in tandem with the Clean Water Act, gives power to the State and Regional Water Boards to implement policies to manage or reduce the flow of pollutant discharges, such as plastic debris, into California's waterways, using enforcement actions such as NPDES permits and TMDLs.

### *NPDES Permits*

---

As mentioned in the Federal section, California administers its own NPDES permits, which allow the state to regulate discharges from industrial facilities, municipal separate storm sewer systems (MS4s), and POTWs. Many of these permits cover discharges of trash in some fashion.

The state is currently using the 1997 Industrial General Storm Water Permit to regulate stormwater discharges from industrial facilities. This permit included plastic pellets under the definition of "significant materials." Under the permit, no discharge of significant materials is allowed (SWRCB, n.d.). The newest Industrial General Storm Water

Permit, which has been under development since 2005, and will go into effect on January 1, 2015, does not allow any discharge of trash (SWRCB, 2012).

According to this pending permit, facilities must ensure that "waste, garbage, or floatable debris are not discharged into receiving waters" (SWRCB, 2012). The new permit also includes a section on preproduction plastic (SWRCB, 2013). Facilities that handle preproduction plastic must implement a containment system with a 1 mm mesh at each on-site storm drain location. If a containment system is not feasible, the facility must implement a

---

suite of Best Management Practices (BMPs) aimed at achieving the same amount of containment as a 1 mm mesh. These BMPs include using properly sealed containers, using capture devices during transfer of preproduction plastic, and having a vacuum for quick cleanups in case of a spill (SWRCB, 2013). Facilities can be exempt if all of their preproduction plastic handling activities (storage, transfer, processing, etc.) are handled inside (SWRCB, 2013). The new BMPs are based off language from AB 258, described in further detail later in this section.

An NPDES MS<sub>4</sub> permit must be obtained by the operator, which is usually a municipality, but can also be a county or agency, such as Caltrans. These permits regulate stormwater discharges from the MS<sub>4</sub>s (CVRWQCB, 2013). In Los Angeles County, there are two main MS<sub>4</sub> permits: one permit is for the unincorporated areas under jurisdiction of Los Angeles County and the 87 municipalities within the county (LARWQCB, 2012) and the other permit is only for Long Beach (LARWQCB, n.d). Additionally, Caltrans has a statewide MS<sub>4</sub> permit that covers a significant area in the watershed (SWRCB, 2012).

Trash is recognized as a pollutant of concern in these permits. In the permit for the county and the 87 municipalities, BMPs are required to deal with trash, such as sweeping operations, litter and debris removal, and emergency response and cleanup practices (LARWQCB, 2012). For the municipalities and county areas that are within the Los Angeles River Watershed and therefore under the regulations of the Los Angeles River TMDL (discussed below), their trash

effluent limitations are included in the permit. Additionally, each operator under the permit must submit an annual TMDL compliance report (LARWQCB, 2012). The City of Long Beach began operating under a new permit at the start of 2014. This permit also included language on the Trash TMDL (LARWQCB, 2013).

All NPDES permits are self-monitored and reported to the State and Regional Water Boards. To ensure proper compliance and reporting, the State and Regional Water Boards perform on-site inspections. When inspecting industrial facilities, the State and Regional Boards have the authority to issue Notice of Violations for poor management practices that may lead to a preproduction plastic spill; it is not necessary for a spill to have occurred (D. Seidner, personal communication, December 5, 2013).

According to the State Water Board's 2012 Resource Alignment Plan, the Board's goal is to inspect 10% of industrial facility permittees, 20% of Phase 1 MS<sub>4</sub> permittees, and 5% of Phase 2 permittees annually (SWRCB, 2012). However, in the 2011-2012 fiscal year, the State Water Board only met 64% of its total inspection goals (SWRCB, 2013). A possible explanation is that the State and Regional Water Boards suffer from a lack of funds for the personnel hours required to conduct inspections, as each industrial inspection may take between 3 to 59 personnel hours and between 1 to 385 personnel hours for enforcement. (D. Seidner, personal communication, July 9, 2013; C. Boschen, personal communication, July 1, 2013; SWRCB, 2012).

The major source of funding for the State and Regional Water Boards is permitting fees. Each permittee must pay a fee each year. In the 2013-2014 fiscal year, the fees for stormwater discharges are \$1,480 for Industrial General Storm Water Permits and \$2,644 to \$211,423 for MS4 permits (SWRCB, 2013). The total amount of funding available to the State Water Board in the 2011-2012 fiscal year was between \$15 and \$17 million, depending on the program (Table 3). These funds are put under three categories for

each program: direct (costs directly used on the program), indirect (administration, management, etc.), and operating and equipment (travel, supplies, etc.) (SWRCB, 2012). The State Water Board’s 2012 Resource Alignment Evaluation Report gave a sample breakdown of these funds. Of the \$14 million in funding received in the 2010-2011 fiscal year for stormwater permitting enforcement, \$7 million went to direct costs, \$1 million to operating and expenses, and \$6 million to indirect costs.

TABLE 3. FUNDING AMOUNT FOR STATE WATER BOARD PROGRAMS (2011-2012 FISCAL YEAR)

Program	Funding Amount
POTW	\$15,748,794
TMDL	\$16,370,570
Stormwater	\$16,050,447

Derived from SWRCB, 2012 – Resource Alignment.

On the regional level, for the 2011-2012 fiscal year, the LARWQCB exceeded its goal of inspecting 200 out of the 2730 industrial stormwater permittees under its jurisdiction

by inspecting 387 facilities (SWRCB, 2012). According to the State Water Board’s website, there were no compliance and penalty actions undertaken for any of these facilities.

### Total Maximum Daily Loads (TMDLs)

The LARWQCB has an aggressive approach to reducing trash in the waterways with its zero trash TMDLs. When a water body’s beneficial uses are recognized as impaired under Section 303(d) of the Clean Water Act, the State or Regional Water Boards are required to restore those beneficial uses. They often do this through TMDLs, which limits the maximum amount of a pollutant that can enter the water body while still maintaining its beneficial uses (LARWQCB, 2011).

In response to the trash problems in the LA River Watershed, the LARWQCB listed the watershed’s beneficial uses as impaired by trash and developed a Trash TMDL (LARWQCB2, 2007). Implemented in 2007, this Trash TMDL requires the 42 municipalities and the areas under jurisdiction of Los Angeles County and Caltrans to achieve a goal of zero trash entering the LA River Watershed by 2016. According to a 2011 LARWQCB resolution, the regulation of zero trash is a

---

“conservative standard which contains an implicit margin of safety.”

The municipalities can be in compliance with a Full Capture System, which has been defined as a storm drain catch basin insert, if it has a 5 mm mesh (LARWQCB<sub>2</sub>, 2007). If a municipality is in compliance, it does not need to monitor trash to see if it is meeting the zero trash goal – it is assumed to be capturing all trash. For municipalities that do not use a full capture system, they must use a combination of structural and non-structural BMPs, as well as monitor and report trash from their catch basins.

By defining full capture as catching debris with a 5 mm screen, the standard purposefully excludes small pieces of trash such as preproduction plastic pellets and other small pieces of plastic that typically range in size from 1 to 5 mm (Moore et al., 2011). In discussions with a Los Angeles County Public Works Engineer, this distinction is mostly due to flooding concerns. A 1 mm mesh would likely clog easily (and often) as debris becomes trapped in the mesh, even in the dry season (J. Guerrero, personal communication, May 21, 2013).

Even with an easier standard of only capturing trash that is 5 mm or larger, the costs to comply with the TMDL are high. The cumulative maintenance and capital costs to implement the Los Angeles River Watershed TMDL for the first ten-year period (2007 to 2016) have been estimated at \$450 million, with \$51.3 million in yearly maintenance costs thereafter (LARWQCB<sub>2</sub>, 2007). A fully implemented Trash TMDL is likely to greatly reduce 5 mm or larger plastic debris inputs to

the LA River Watershed. This may also reduce the amount of 5 mm or smaller plastic debris in the river by either capturing smaller pieces of plastic along with 5 mm or larger pieces in the catch basins, or by capturing larger pieces of plastic that would have broken down into 5 mm or smaller pieces once in the environment. However, it is assumed that plastic that starts at sizes of 5 mm or smaller, such as preproduction plastic pellets, or plastic that has broken down into 5 mm or smaller pieces on land, would not be reduced significantly by the Trash TMDL.

While TMDLs and NPDES programs are different, TMDL language can be incorporated into an NPDES permit. When TMDLs are set at a specific level necessary for applicable water standards, NPDES permits must be in compliance with those TMDLs. For example, the current MS<sub>4</sub> NPDES permit that covers 84 municipalities and unincorporated areas in the county now includes the waste load allocations from the LA River Trash TMDL.

Trash TMDLs were also implemented for the East Fork of the SG River and for Legg Lake, two small portions of the SG River Watershed, due to impairment of the beneficial uses. A Trash TMDL was adopted for the East Fork of the SG River in 2001 (LARWQCB, 2000). This was in response to the high amounts of trash left behind by recreational users of the areas. For the East Fork TMDL, the U.S. Forest Service estimated that over 200 32-gallon bags worth of trash were left as litter every weekend due to recreational uses, such as picnicking and barbecuing. Similar to the LA River TMDL, a zero trash goal was set to restore the beneficial uses of the East Fork.



---

The difficulty with meeting this TMDL was the nonpoint source nature of the trash from stormwater and wind transport. BMPs such as additional trash receptacles, more frequent cleanups, and anti-littering signs were implemented to meet the TMDL. (LARWQCB, 2000).

The Legg Lake TMDL was created in 2008 due to similar problems of recreational users leaving behind trash, but also from storm drains in adjacent land uses and roadways (LARWQCB1, 2007). Legg Lake is on the San Gabriel River in South El Monte. The typical trash in this area was cited as polystyrene cups and cans (CWB, 2007). A zero trash TMDL for the lake was imposed. For those jurisdictions with storm drains around the lake, full capture could be achieved with a 5 mm capture system, similar to the LA River TMDL. Jurisdictions with nonpoint sources were to comply with BMPs and monitoring (LARWQCB1, 2007). If any other reaches of the San Gabriel River Watershed are to fall under a Trash TMDL, they will first have to be designated as impaired by the LARWQCB.

The Santa Monica Bay Nearshore Debris TMDL, enacted on March 28, 2012 by the LARWQCB, uses language from Section 13367 to require zero plastic pellet discharges into waterways that empty into the Santa Monica Bay from industries that work with plastic (LARWQCB, 2013). However, under the Industrial Storm Water General Permit (ISWGP), zero discharges of trash, which includes plastic pellets, is already prohibited (SWRCB, 2012). The language may be in the TMDL to increase awareness. In the TMDL, the industries have five years to meet the zero

plastic pellet limit; although under the ISWGP they should already be achieving zero pellet discharge.

Additionally, the TMDL requires a plastic pellet monitoring and reporting plan for each municipality covered under the TMDL, except those that have no industrial facilities under their jurisdictions (LARWQCB, 2013). The plastic pellet monitoring and reporting plan requires two monitoring events per year at each storm drain outfall in the TMDL boundaries. The TMDL encourages municipalities to conduct more inspections of industries that handle plastic pellets in their region if they find a violation of the zero plastic pellet waste load allocation.

The Santa Monica Nearshore Debris TMDL also addresses nonpoint sources, which the LA River Trash TMDL does not. The nonpoint sources considered are beaches, parks, parking lots, and hiking areas. The goal for the nonpoint sources is zero trash. The municipalities with jurisdiction over these areas will be in compliance with the TMDL by creating and implementing a BMP and Minimum Frequency of Assessment and Collection Program.

The LA River Watershed does not empty into the Santa Monica Bay, and all waterways that the Santa Monica Bay Nearshore Debris TMDL applies to are in the Ballona Creek Watershed. However, if this TMDL is effective at reducing plastic pellet discharges, it may be a blueprint for similar regulations in the LA and SG River Watersheds.

---

## *Assembly Bill 258 (AB 258)*

---

With the increased attention put on the issue of plastic debris in rivers, beaches, and oceans in the late 1990s and early 2000s, policy makers in California began to search for solutions to reduce the inputs of preproduction plastic into the state's waterways. In early 2007, Paul Krekorian, a State Assembly member from the Los Angeles area, proposed AB 258, a bill focused on plastic pellet litter reduction. The California Legislature passed AB 258 on September 10, 2007, which added Chapter 5.2, Section 13367 to the Porter-Cologne Water Quality Control Act (PCWQCA, 1969). Section 13367 requires State and Regional Water Boards to establish programs to control the discharge of preproduction plastic, in pellet and powder form, from nonpoint and point sources.

According to the State Water Board's website, the bill has led to State and Regional Water Board inspections of preproduction plastic handling, manufacture, and transportation for facilities enrolled under California's ISWGP for stormwater discharges, enforcement actions, as well as stakeholder outreach and coordination (SWRCB, 2012).

According to the law, the State Water Board must include language in the ISWGP that requires facilities that handle preproduction plastic to have five Best Management

Practices (BMPs), including there being a 1 mm containment system in onsite storm drains or BMPs that are the equivalent to the capacity of a 1 mm containment system (CA AB 258, 2013-2014; CEPA, 2012). The State Water Board has included these BMPs for first time in the 2015 ISGWP. However, they are fairly general as there are wide varieties of preproduction plastic handlers that are covered in the ISGWP that can have drastically different industrial practices (D. Seidner, personal communication, July 9, 2013).

One of the most notable enforcement actions of Section 13367 and the ISGWP with regards to preproduction plastic occurred in December 2011. The San Francisco Regional Water Quality Control Board, the State Water Resources Control Board (SWRCB), and the EPA found that four San Leandro plastic manufacturers had been negligent in their handling of preproduction plastic pellets. Millions of pellets had entered the San Francisco Bay due to discharges through storm drains from their industrial sites (Fimrite, 2011). The companies were mandated to develop procedures to prevent future spills and are now in the process of paying for a two-year cleanup of the pellets in the San Francisco Bay near where their storm drains discharged.

---

## *Industry*

---

The plastics industry has initiated policies to reduce plastic debris. The Society of the Plastics Industry (SPI) created a set of voluntary BMPs in 1991 to reduce preproduction pellet loss, called Operation

Clean Sweep (OCS). The Plastics Division of the American Chemistry Council joined OCS in 2004. The goal of these BMPs is a combination of reducing pellet loss from occurring in the first place, as well as practices

---

to reduce pellet loss to the storm drains after spills. These BMPs were updated in 2005, with the assistance of SPI, AMRI, and the LARWQCB, after new attention was brought to the problem of pellets making their way to rivers, beaches, and the ocean from industrial sites.

Being a participant in OCS does not require any measurement of pellet loss and reduction. SPI believes that adding a layer of complexity with measurements would make it more difficult to get facilities to adopt it (P. Long, personal communication, July 19, 2013). The only direct quantification of the effectiveness of OCS was a study conducted by AMRI along the LA and SG Rivers. This study found that when OCS BMPs were implemented across 10 plastic industrial facilities, the amount of pellet runoff to storm drains was reduced by 57% (from 221,139 pieces of plastic debris to 93,325 pieces), although this varied widely across each facility (Moore et al., n.d.). The amount of pellets that could potentially be transported to the waterways (i.e., pellets found on the ground that could be mobilized by water or wind) was reduced by 75% (Moore et al., n.d.). While these numbers potentially show that these BMPs are effective, there was still significant pellet loss (Moore et al., n.d.). Each facility knew that AMRI would return to measure the changes in pellet loss. Therefore, these sites may have initiated OCS practices solely because they were being monitored and it may not be representative of plastic industry operations as a whole.

A 2010 survey by the State Water Board found that of the 438 plastic facilities surveyed, 235 handled preproduction plastic. Of those,

only 12.9% were enrolled in OCS (Seidner, 2010). Given that the program has been around for over 20 years, this is a very low adoption rate. Additionally, according to the OCS website, only 8 companies in the LA River Watershed (7% of the total) and 4 companies in the SG River Watershed (30% of the total) have signed the pledge to become an OCS program partner and implement the BMPs at their sites.

In March 2011, SPI, the American Chemistry Council, and other plastic organizations across the world signed the Declaration of the Global Plastics Associations for Solutions on Marine Litter (GPA, 2011). As the name of the Declaration states, the goal is for the plastic associations and the companies they represent to find ways to reduce plastic debris. The Declaration identified six areas that the plastic associations would focus on to reduce plastic debris: education, research, public policy, best practices, recycling and recovering plastics, and plastic pellet containment (GPA, 2011). In a December 2012 progress report, 58 plastic organizations across 34 countries were recognized as having signed the Declaration (GPA, 2012). Additionally, 140 projects to reduce plastic debris that were planned, underway, or completed, were identified as fulfilling the Declaration. According to the progress report, this was a nearly 50% increase in the number of projects since the announcement of the Declaration. The only projects listed in the progress report under plastic pellet containment were OCS, which was already in place before the Declaration. No quantifiable results were presented in the declaration or the progress report.

---

# APPENDIX D – SUMMARY OF RESEARCH ON BIOTIC CONSUMPTION AND ENTANGLEMENT

---

Summaries may include text taken directly from the articles.

BIOTIC CONSUMPTION AND ENTANGLEMENT	
CITATION	BRIEF SUMMARY
Ahrens et al., 2001	<p>The extent to which sediment-bound contaminants pose a risk to benthic organisms largely depends on their bioavailability. Deposit-feeding polychaetes are particularly subject to high HOC exposure since they ingest large amounts of sediment (commonly at rates exceeding several times their body weight per day).</p>
Allsopp et al., 2006	<p>Ingestion of marine debris is known to particularly affect sea turtles and seabirds but is also a problem for marine mammals and fish. Ingestion is generally thought to occur because the marine debris is mistaken for prey. Most of that erroneously ingested is plastic. Different types of debris are ingested by marine animals including plastic bags, plastic pellets and fragments of plastic that have been broken up from larger items. The biggest threat from ingestion occurs when it blocks the digestive tract, or fills the stomach, resulting in malnutrition, starvation and potentially death.</p> <p>Studies have shown that a high proportion (about 50 to 80%) of sea turtles found dead are known to have ingested marine debris. This can have a negative impact on turtle populations. In young turtles, a major problem is dietary dilution in which debris takes up some of the gut capacity and threatens their ability to take on necessary quantities of food. For seabirds, 111 out of 312 species are known to have ingested debris and it can affect a large percentage of a population (up to 80%). Moreover, plastic debris is also known to be passed to the chicks in regurgitated food from their parents. One harmful effect from plastic ingestion in birds is weight loss due for example to a falsely sated appetite and failure to put on adequate fat stores for migration and reproduction.</p>

---

## BIOTIC CONSUMPTION AND ENTANGLEMENT

CITATION	BRIEF SUMMARY
Aloy et al., 2011	This study analyzed the foraging behavior of the gastropod <i>Nassarius pullus</i> on garbage-impacted sandy shores of Talim Bay, Batangas, Philippines. The effect of different levels of plastic garbage cover on foraging efficiency was investigated. Controlled in situ baiting experiments were conducted to quantify aspects of foraging behavior as affected by the levels of plastic litter cover in the foraging area. The results of the study indicated that the gastropod's efficiency in locating and in moving towards a food item generally decreased as the level of plastic cover increased. Prolonged food searching time and increased self-burial in sand were highly correlated with increased plastic cover. The accuracy of orientation towards the actual position of the bait decreased significantly when the amount of plastic cover increased to 50%. These results are consistent with the significant decreases in the abundance of the gastropod observed during periods of deposition of large amounts of plastic and other debris on the shore.
Auman et al., 2004	Seabird carcasses were collected between October 2000 and January 2001 around Atlas Cove, an unglaciated region on the northwestern coast of Heard Island. Of the 18 carcasses dissected, we found only two birds, both Antarctic Prions, with plastic particles inside their digestive systems.
Baird et al., 2000	Since many species of whales and dolphins live in waters far from shore, and may sink upon death, opportunities to record instances of ingestion of marine debris by cetaceans are infrequent. Despite this, there are several cases where ingestion of plastic or other marine debris has been documented for cetaceans, with published reports existing for 21 species of odontocetes (Laist, 1997). An additional five species of odontocetes for which marine debris ingestion have since been documented: the killer whale, northern bottlenose whale finless porpoise, white-beaked dolphin, and pantropical spotted dolphin.



---

## BIOTIC CONSUMPTION AND ENTANGLEMENT

CITATION	BRIEF SUMMARY
Bakir et al., 2014	Microplastics have the potential to uptake and release persistent organic pollutants (POPs); however, subsequent transfer to marine organisms is poorly understood. Desorption under gut conditions could be up to 30 times greater than in seawater alone. Of the POP/plastic combinations examined Phe with PE gave the highest potential for transport to organisms.
Blight et al., 1997	Plastic was found in all surface-feeding birds (two stormpetrel, one albatross, one petrel and one fulmar species) and in 75% of shearwaters. Densities in some stormpetrels, shearwaters and the petrel were possibly sufficient to impede digestion, but were negligible in other birds. Plastic was also found in two diving species (puffins) but absent in three others (murre, auklet and murrelet). Of 353 anthropogenic items examined, 29% were industrial pellets and 71% were fragments of discarded products ('user' plastic), with user plastic making up 60% of total mass.
Boerger et al., 2010	Approximately 35% of the common planktivorous fish studied had ingested plastic, averaging 2.1 pieces per fish.
Bond et al., 2013	Combined previously unpublished data on plastic ingestion (from the 1980s to the 1990s) with contemporary samples (2011–2012) to evaluate changes in murre's plastic ingestion. Approximately 7% of murre's had ingested plastic, with no significant change in the frequency of ingestion among species or periods. The number of pieces of plastic/bird, and mass of plastic/bird were highest in the 1980s, lowest in the late 1990s, and intermediate in contemporary samples
Bonda et al., 2011	Analysed the frequency of ingested plastic in chick meals delivered by adults in four species of auklet over a 14-year period from 1993 to 2006. Among 2541 chick meals, found plastic in only one. However, adult Parakeet Auklets have a high frequency of plastic ingestion (over 90%), but no chick meals contained plastic.

---

## BIOTIC CONSUMPTION AND ENTANGLEMENT

CITATION	BRIEF SUMMARY
Bourne et al., 1981	It seems likely that most seabirds eventually regurgitate plastic pellets with other indigestible matter. It is not entirely clear to what extent the petrels, in which pellets appear to be found most commonly, do this. It seems possible that if the birds do not regurgitate solid matter and start to accumulate many pellets, these may come to interfere with their digestion. On the other hand, the examination of the stomachs of beached birds, which are nearly always starving, suggests that hungry individuals may often eat a variety of indigestible matter. Thus it seems difficult to determine whether the plastic pellets are a cause or effect of their starvation. In any case it seems a cause for concern that pellets are now becoming dispersed and picked up by wildlife so widely.
Browne et al., 2008	The consequences of macroplastic debris for wildlife are well documented, however the impacts of microplastic (<1 mm) are poorly understood. The mussel, <i>Mytilus edulis</i> , was used to investigate ingestion, translocation, and accumulation of this debris. Initial experiments showed that upon ingestion, microplastic accumulated in the gut. Abundance of microplastic was greatest after 12 days and declined thereafter. Smaller particles were more abundant than larger particles and our data indicate as plastic fragments into smaller particles, the potential for accumulation in the tissues of an organism increases.
Bugoni et al., 2001	Stomachs of 37 dead sea turtles examined. Found plastic bags and clear pellets. Concluded that anthropogenic materials caused about 13 percent of the deaths examined.
Buxton et al., 2013	Surveyed six offshore islands on the northeast coast of New Zealand's North Island for burrow-nesting seabird colonies and the presence of plastic fragments. Conclude that plastic ingestion is a potentially a serious issue for flesh-footed shearwaters in New Zealand.

---

## BIOTIC CONSUMPTION AND ENTANGLEMENT

CITATION	BRIEF SUMMARY
Campani et al., 2013	Evaluated the presence and the frequency of occurrence of marine litter in the gastrointestinal tract of 31 <i>Caretta caretta</i> found stranded or accidentally bycaught in the North Tyrrhenian Sea. Marine debris were present in 71% of specimens and were subdivided in different categories according to Fulmar Protocol (OSPAR 2008). The main type of marine debris found was user plastic, with the main occurrence of sheetlike user plastic.
Carr, 1987	There is massive evidence that entrapment, entanglement, and impact on sea turtles by ingested plastics have become major threats to their survival.
Carson et al., 2013	One of the primary threats to ocean ecosystems from plastic pollution is ingestion by marine organisms. Well-documented in seabirds, turtles, and marine mammals, ingestion by fish and sharks has received less attention until recently. We suggest that fishes of a variety of sizes attack drifting plastic with high frequency, as evidenced by the apparent bite marks commonly left behind.
Colabuono et al., 2009	The Procellariiformes are the birds most affected by plastic pollution. Plastic fragments and pellets were the most frequent items found in the digestive tract of eight species of Procellariiformes incidentally caught by longline fisheries as well as beached birds in Southern Brazil. Plastic objects were found in 62% of the petrels and 12% of the albatrosses.
Cole et al., 2011	Ingestion of microplastics has been demonstrated in a range of marine organisms, a process which may facilitate the transfer of chemical additives or hydrophobic waterborne pollutants to biota.
Connors et al., 1982	In a sample of seven red phalaropes collected from a flock of 6000 late spring migrants, six stomachs contained plastic particles. A negative correlation between amount of plastic and fat condition suggests a detrimental effect of a widespread oceanic pollutant on a marine bird.

---

## BIOTIC CONSUMPTION AND ENTANGLEMENT

CITATION	BRIEF SUMMARY
Costa et al., 2011	Nylon fragments from cables used in fishery activities (subsistence, artisanal and commercial) played a major role in this contamination. These catfish spend their entire life cycles within the estuary and are an important feeding resource for larger, economically important, species. It is not yet possible to quantify the scale and depth of the consequences of this type of pollution. However, plastics are well known threat to living resources in this and other estuaries.
Elskus et al., 2005	Study of lipid composition differences in tissues, and over life cycles and seasons, can be strong predictors of POP disposition in fish.
Eriksson et al., 2003	One hundred and sixty four plastic particles (mean length 4.1 mm) recovered from the scats of fur seals ( <i>Arctocephalus</i> spp.) on Macquarie Island. None could be identified as plastic pellet feedstock from their shapes. Commonly, such pellets are cylindrical and spherical. Instead, all the 164 plastic particles from the seal scats were angular particles of 7 colors (feedstock particles are normally opaque or white) and could be classified into 2 categories: i) fragmented along crystal lines and likely to be the result of UV breakdown; and ii) worn by abrasion (where striations were clearly visible) into irregular shapes with rounded corners. White, brown, green, yellow and blue were the most common colors. In composition, they came from 5 polymer groups; polyethylene 93%, polypropylene 4%, poly(1-Cl-1-butenylene) polychloroprene 2%, melamine-urea (phenol) (formaldehyde) resin 0.5%, and cellulose (rope fiber) 0.5%.
Furness, 1983	Small plastic particles were found in White-chinned Petrels and Great Shearwaters collected in the Benguela Current, but not in Sooty Shearwaters collected in the same region. The origin of these particles is unclear. They may have originated in the Antarctic or subantarctic, or, in the case of those found in the Great Shearwaters, in the North Atlantic. Plastic particle pollution of seabirds is an increasing phenomenon, and of concern in view of the possible damage caused to the birds. As such it should be carefully monitored.

---

## BIOTIC CONSUMPTION AND ENTANGLEMENT

CITATION	BRIEF SUMMARY
Goldstein et al., 2012	One potential mechanism for microplastic-induced alteration of pelagic ecosystems is through the introduction of hard-substrate habitat to ecosystems where it is naturally rare. Study showed a two-fold increase in microplastic concentrations correlated with an increase in the egg density of a pelagic insect ( <i>Halobates sericeus</i> ).
Graham et al., 2009	Weathering of plastic bottles, bags, fishing line, and other products discarded in the ocean causes tiny fragments to break off. These plastic fragments may accumulate biofilms, sink, and become mixed with sediment, where benthic invertebrates may encounter and ingest them.
Gregory, 2009	Environmental Implications of Plastic debris in marine settings-entanglement, ingestion, smothering, hangers-on, hitch-hiking and alien invasions.
Ivar do Sul et al., 2013	Synthetic polymers are present in subsurface plankton samples around Saint Peter and Saint Paul Archipelago in the Equatorial Atlantic Ocean.
Jacobsen et al., 2010	In 2008 two male sperm whales ( <i>Physeter macrocephalus</i> ) stranded along the northern California coast with large amounts of fishing net scraps, rope, and other plastic debris in their stomachs. These strandings demonstrate that ingestion of marine debris can be fatal to large whales, in addition to the well documented entanglements known to impact these species.



---

## BIOTIC CONSUMPTION AND ENTANGLEMENT

CITATION	BRIEF SUMMARY
Kershaw et al., 2011	Ingestion of plastics mistaken for food is well documented in seabirds, sea turtles and marine mammals and can be fatal. Ingested particles may cause an obstruction or otherwise damage the gut lining. Alternatively, these particles may result in poor nutrition through being substituted for food (although this appears to be species specific). The concentration of contaminants by microplastic particles presents the possibility of increasing exposure to organisms through ingestion and entrance into the food chain—with the prospect of biomagnification in top-end predators in the food chain such as swordfish and seals. Ingestion of small particles by a wide variety of organisms has been well reported. Physical effects, such as the entanglement of seals and other animals in drift plastic, increase with the size and complexity of the debris.
Lattin et al., 2001	The mass of plastic collected exceeded that of zooplankton, although when the comparison was limited to plastic debris similar to the size of most zooplankton, zooplankton mass was three times that of debris.
Lavers et al., 2013	Compared the prevalence and composition of debris in nests and along the beach at two Brown Booby ( <i>Sula leucogaster</i> ) colonies on Ashmore Reef, Timor Sea, a remote area known to contain high densities of debris transported by ocean currents. The proportion of nests with debris varied across islands (range 3–31%), likely in response to the availability of natural nesting materials. Boobies exhibited a preference for debris colour (white and black), but not type.
Lee et al., 2013	Investigated the effects of three sizes of polystyrene (PS) microbeads (0.05, 0.5, and 6- $\mu$ m diameter) on the survival, development, and fecundity of the copepod <i>Tigriopus japonicus</i> using acute and chronic toxicity tests. Results suggest that microplastics such as micro- or nanosized PS beads may have negative impacts on marine copepods.

---

## BIOTIC CONSUMPTION AND ENTANGLEMENT

CITATION	BRIEF SUMMARY
Meredith, 2013	The plastic peril inflicting our oceans is now so severe humans are ingesting particles of litter, a leading marine expert has warned. The vast quantities of plastics which litter the UK's oceans are not only a real danger to sea life but could also threaten humans too, Paul Rose, the vice president of the Royal Geographical Society, has said.
Moore et al., 2002	The average mass of plastic was two and a half times greater than that of plankton, and even greater after a storm event.
Moore et al., 2001	Plankton abundance was approximately five times higher than that of plastic, but the mass of plastic was approximately six times higher than that of plankton.
Moser et al., 1992	Analyzed the gut contents of 1033 birds collected off the coast of North Carolina from 1975-1989. Twenty-one of 38 seabird species (55%) contained plastic particles. Procellariiform birds contained the most plastic and the presence of plastic was clearly correlated with feeding mode and diet. Plastic ingestion by procellariiforms increased over the 14 year study period, probably as a result of increasing plastic particle availability. Some seabirds showed a tendency to select specific plastic shapes and colors, indicating that they may be mistaking plastics for potential prey items. Found no evidence that seabird health was affected by the presence of plastic, even in species containing the largest quantities.
Murray et al., 2011	Plastic contamination was found to be high in Nephrops, 83% of the animals sampled contained plastics (predominately filaments) in their stomachs. Tightly tangled balls of plastic strands were found in 62% of the animals studied but were least prevalent in animals which had recently moulted.
Petry et al., 2009	The present study analyzed the diet of Cory's Shearwater along the coast of Rio Grande do Sul based on the stomach contents of 185 birds found dead during beach surveys between July 1997 and July 1998. Food items were classified taxonomically and non-food items were categorized. Synthetic materials were found in 81% of stomachs.

---

## BIOTIC CONSUMPTION AND ENTANGLEMENT

CITATION	BRIEF SUMMARY
Provencher et al., 2010	Surface feeding seabirds typically ingest high levels of plastic, while the diving auks which feed in the water column typically have much lower levels. Examined 186 thick-billed murrelets from five colonies in the eastern Canadian Arctic for ingested plastic debris. Approximately 11% of the birds had at least one piece of plastic debris in their gastrointestinal tracts, with debris dominated by user plastics.
Richards et al., 2011	Marine debris causes suffocation, shading, tissue abrasion and mortality of corals and we a significant negative correlation exists between the level of hard coral cover and coverage of marine debris.
Robards et al., 1995	Examined gut contents of 1799 seabirds in 1988-1990 to assess the types and quantities of plastic particles ingested in the subarctic waters of Alaska. Comparison with similar data from 1968 seabirds comprising 37 species collected in 1969-1977 revealed that plastic ingestion by seabirds has increased significantly during the 10-15-year interval between studies.
Rodriguez et al., 2013	The quantification of entanglements of megafauna with plastic debris at sea is difficult to assess for several reasons, such as detection and reporting biases. Used standardized vessel based counts to describe and quantify the occurrence of marine debris entanglements in northern gannets <i>Morus bassanus</i> at five of its main wintering areas. Observed 34 entangled birds in total, representing 0.93% of all gannets counted (n = 3672 individuals).
Ruus et al., 2005	A test-system for the assessment of bioavailability and bioaccumulation of metals and organic contaminants in marine benthic organisms is described and results from studies where this system has been applied are assessed. Sediments tested were polluted harbour sediment (from Norway), and clean sediments spiked with metal containing weight materials for drilling muds. Compared to other PAHs, pyrene was found to bioaccumulate to a high degree, which shows that extrapolating bioaccumulation results between different substances is difficult.

---

## BIOTIC CONSUMPTION AND ENTANGLEMENT

CITATION	BRIEF SUMMARY
Ryan et al., 1987	The assimilation efficiencies of fledgling Whitechinned Petrels <i>Procellaria aequinoctialis</i> artificially fed large quantities of plastic particles were assessed. No significant differences were detected in either assimilation efficiency or the rate of mass loss between experimental and control birds. Polyethylene pellets lost 1% of their mass after 12 days in the experimental birds' stomachs, suggesting a half-life of at least one year. No instances of plastic causing intestinal obstruction, and few cases of physical damage to the stomach lining, were found in over 400 individuals of 25 species of seabirds containing ingested plastic. These results suggest ingested plastic seldom impairs digestive efficiency in seabirds.
Ryan, 1988	Domestic chickens <i>Gallus domesticus</i> were fed polyethylene pellets to test whether ingested plastic impairs feeding activity. When food was temporally limited, plastic-loaded birds ate less than control birds, apparently as a result of reduced gizzard volume. When given food ad libitum, plastic-loaded birds also ate less and grew slower than did control birds. It is concluded that ingested plastic reduces meal size and thus food consumption when plastic reduces the storage volume of the stomach. This reduced food consumption may limit the ability of seabirds with large plastic loads to lay down fat deposits, and thus reduce fitness.
Ryan, 2008	Compared plastic ingested by five species of seabirds sampled in the 1980s and again in 1999–2006. The numbers of ingested plastic particles have not changed significantly, but the proportion of virgin pellets has decreased 44–79% in all five species: great shearwater <i>Puffinus gravis</i> , white-chinned petrel <i>Procellaria aequinoctialis</i> , broad-billed prion <i>Pachyptila vittata</i> , white-faced storm petrel <i>Pelagodroma marina</i> and white-bellied storm petrel <i>Fregetta grallaria</i> . The populations sampled range widely in the South Atlantic and western Indian Oceans. The most marked reduction occurred in great shearwaters, where the average number of pellets per bird decreased from 10.5 to 1.6. The consistent decrease in pellets in birds suggests there has been a global change in the composition of small plastic debris at sea over the last two decades.

---

## BIOTIC CONSUMPTION AND ENTANGLEMENT

CITATION	BRIEF SUMMARY
Sazima et al., 2002	Three juvenile Brazilian sharpnose sharks ( <i>Rhizoprionodon lalandii</i> ) caught in gillnets in southeast Brazil, southwest Atlantic, were found with plastic debris rings around their gill or mouth region. The rings caused severe abrasion on the sharks' tissues as the animal grew, the collars probably hampering normal feeding and/or ventilation since two of the collared individuals were emaciated. The rings were identified as detachable lid parts from plastic bottles, likely thrown overboard by fishery and/or recreation boats.
Schulyer et al., 2013	Analyzed 37 studies published from 1985 to 2012 that report on data collected from before 1900 through 2011. Specifically, we investigated whether ingestion prevalence has changed over time, what types of debris are most commonly ingested, the geographic distribution of debris ingestion by marine turtles relative to global debris distribution, and which species and life-history stages are most likely to ingest debris. The probability of green ( <i>Chelonia mydas</i> ) and leatherback turtles ( <i>Dermochelys coriacea</i> ) ingesting debris increased significantly over time, and plastic was the most commonly ingested debris.
Shaw et al., 1994	Floating plastic was collected at 27 locations in the North Pacific Ocean in 1987 and 1988. They sorted the plastic documented size and color, and concluded that plastics are often mistaken for prey items. Ingestion of small plastic objects by marine organisms likely occurs in substantial quantities.
Stamper et al., 2006	On 24 November 1993, an emaciated juvenile female pygmy sperm whale, <i>Kogia breviceps</i> , was found stranded in Great Inlet, Longport, New Jersey. Over 6 weeks, five endoscopic procedures resulted in the recovery of a 20 cm × 22.5 cm sheet of black plastic, a portion of plastic garbage bag, a cellophane wrapper, cigarette box wrapper, portion of a mylar balloon, and other small unidentifiable pieces of plastic material. She made it back to the wild in good health!



---

## BIOTIC CONSUMPTION AND ENTANGLEMENT

CITATION	BRIEF SUMMARY
Teuten et al., 2007	Plastic debris ingested by numerous species of animals, causing deleterious physical effects. High concentrations of hydrophobic organic contaminants have also been measured on plastic debris collected from the environment, but the fate of these contaminants is examined here. Reviews the release of phenanthrene by three plastics. Conclude that plastics may be important agents in the transport of hydrophobic contaminants to sediment-dwelling organisms.
Teuten et al., 2009	Some plastics have PCBs from manufacturing, some are picked up from their surroundings. Both a mathematical model and laboratory experiment have shown transfer of PCBs from plastic to shearwater chicks.
Todd et al., 2010	Review the effects of sediments, eutrophication, toxics and marine litter.
Tourhino et al., 2010	This study investigates the current status of marine debris ingestion by sea turtles and seabirds found along the southern Brazilian coast. All green turtles (n = 34) and 40% of the seabirds (14 of 35) were found to have ingested debris. No correlation was found between the number of ingested items and turtle's size or weight. Most items were found in the intestine. Plastic was the main ingested material. Twelve Procellariiformes (66%), two Sphenisciformes (22%), but none of the eight Charadriiformes were found to be contaminated. Procellariiformes ingested the majority of items. Plastic was also the main ingested material. The ingestion of debris by turtles is probably an increasing problem on southern Brazilian coast. Seabirds feeding by diverse methods are contaminated, highlighting plastic hazard to these biota.

---

## BIOTIC CONSUMPTION AND ENTANGLEMENT

CITATION	BRIEF SUMMARY
UNEP, 2006	<p>A high concentration of marine debris on the seafloor affected both the number and type of marine organisms that inhabited the area (Uneputty and Evans 1997).</p> <p>Marine debris on the seabed can inhibit the gas exchange between overlying waters and the pore waters of the sediments, which can result in less oxygen in the sediments. This can interfere with organisms that live on the seafloor and potentially affect this ecosystem. Organisms living on the seabed would also be at risk from entanglement or ingestion of marine debris (Derraik 2002). A review of entanglement and ingestion of marine debris by marine organisms conducted in 1996, showed that these phenomena had been known to affect individuals of at least 267 species worldwide. This included 86% of all sea turtles, 44% of all seabird species, 43% of all marine mammal species and numerous fish and crustacean species (Laist, 1997). Many species are known to have suffered entanglement including 32 species of marine mammals, 51 species of seabirds and 6 species of sea turtles. Entanglement has been recorded in six of the seven existing sea turtle species. It has been a widespread phenomenon occurring in many ocean areas. The majority of entanglements involve monofilament line, rope or commercial trawl nets and gillnets. A study on northern fur seals in the Bering Sea estimated that 40,000 seals a year were being killed by plastic entanglement (Derraik 2002).</p> <p>Based on entanglement rates, it was estimated that 1478 entangled fur seals and sea lions die each year in southern Australia. The greatest cause of entanglements in seabirds was monofilament line and fishing net. Other commonly reported entanglements were due to fishing hooks, six-pack yokes, wire and string (Laist 1997). Many marine organisms can be caught in ghost nets and the amount of lost or discarded nets is vast. In the U.S. it was estimated that \$250 million of marketable lobster is lost annually to ghost fishing (JNCC 2005).</p>

---

## BIOTIC CONSUMPTION AND ENTANGLEMENT

CITATION	BRIEF SUMMARY
Van Franeker et al., 1988	Plastic particles were found to be common pollutants in stomachs of Wilson's Storm Petrels and Cape Petrels breeding on the Antarctic continent. Highest incidence of plastics was found in chicks of Wilson's Storm Petrels that had died before fledging. Few or no plastics were found in Snow Petrels and Antarctic Petrels. Evidence suggests that most plastics originate from wintering areas outside the Antarctic, and that relatively few plastics are available in Antarctic waters.
Van Franeker, 1985	Fulmars found dead on the Dutch coast, and fulmars collected in arctic colonies have considerable quantities of plastic in their stomachs. The average number of plastic items ingested is almost twelve in Dutch fulmars, and four to five in arctic fulmars. User-plastics and industrial plastics are about equally abundant. Ingestion of user-plastics suggests a stronger impact of toxic chemicals from plastics than generally assumed.
Wagner et al., 2009	Provides first evidence that substances leaching from plastic food packaging materials act as functional estrogens in vivo.
Waluda et al., 2013	Between November 1989 and March 2013, 1033 Antarctic fur seals <i>Arctocephalus gazella</i> were observed entangled in marine debris at Bird Island, South Georgia. The majority of entanglements involved plastic packaging bands (43%), synthetic line (25%) or fishing net (17%). Juvenile male seals were the most commonly entangled (44%).
Wargo et al., 2008	This report looks at chemicals in plastics that are commonly used in packaging, wiring, and toys. They examine how bisphenol A (BPA) and Di(2-ethylhexyl) phthalate (DEHP), disrupt normal growth and development in many different species of animals due to their hormonal activity.

---

## BIOTIC CONSUMPTION AND ENTANGLEMENT

### CITATION

### BRIEF SUMMARY

Zettler et al.,  
2013

Study unveiled a diverse microbial community of heterotrophs, autotrophs, predators, and symbionts, a community they refer to as the "Plastisphere." Some Plastisphere members may be opportunistic pathogens (the authors, unpublished data) such as specific members of the genus *Vibrio* that dominated one of our plastic samples. Plastisphere communities are distinct from surrounding surface water, implying that plastic serves as a novel ecological habitat in the open ocean. Plastic has a longer half-life than most natural floating marine substrates, and a hydrophobic surface that promotes microbial colonization and biofilm formation, differing from autochthonous substrates in the upper layers of the ocean.

---

## APPENDIX E – SUMMARY OF RESEARCH ON TRANSPORT MECHANISMS

---

Summaries may include text taken directly from the articles.

TRANSPORT MECHANISM	
REFERENCE	BRIEF SUMMARY OF FINDINGS
Allsopp et al., 2006	Plastic debris which floats on the oceans can act as rafts for small sea creatures to grow and travel on. Plastic can travel for long distances and therefore there is a possibility that marine animals and plants may travel to areas where they are non-native. Plastic with different sorts of animals and plants have been found in the oceans in areas remote from their source.
Ashton et al., 2010	Given their size and buoyancy, pellets afford a means of ready transportation of metals and other contaminants to open surface waters where their relative importance in suspension is much greater.
Barnes, 2004	Supralittoral hermit crabs on remote Indian Ocean shores are starting to use debris instead of the more usual gastropod shells due to its abundance.
Barnes et al., 2003	At least 10 species belonging to 5 phyla were present on one piece of plastic and the size of some indicated that it had been afloat for more than a year. Clearly it is possible for a range of animals to survive and grow in such an environment, and so exotic species could enter or leave the Southern Ocean.
Barnes, 2002	Human litter more than doubles the rafting opportunities for biota, particularly at high latitudes.



---

## TRANSPORT MECHANISM

REFERENCE	BRIEF SUMMARY OF FINDINGS
Hinojosa et al., 2011	Floating objects are suggested to be the principal vector for the transport and dispersal of marine invertebrates with direct development as well as catalysts for carbon and nutrient recycling in accumulation areas.
Kershaw et al., 2011	Floating plastic objects or fragments also provide a temporary “home” or vector for invasive species, including sessile invertebrates, seaweeds and pathogens.

## BIODIVERSITY

REFERENCE	BRIEF SUMMARY OF FINDINGS
Goldberg, 1997	Plastic debris entering the marine environment ultimately ends up on the seafloor where it can alter the nature of the benthic community by inhibiting gas exchange between the pore waters and the overlying waters, by ingestion or by providing habitat to opportunistic organisms.

---

# APPENDIX F – SUMMARY OF RESEARCH ON DEGRADATION AND CONTAMINANTS

---

Summaries may include text taken directly from the articles.

DEGRADATION	
CITATION	BRIEF SUMMARY
Andrady et al., 1988	Rate of deterioration as indicated by the loss in mean ultimate extension was found to be slower when the material was weathered in sea water compared to that in air. The difference in rates is explained in terms of the lack of heat buildup in plastic material floating in sea water.
Artham et al., 2009	The Bisphenol A polycarbonate can degrade slowly in the marine environment.
Cooper et al., 2010	Particles sampled were analyzed to determine the effects of mechanical and chemical processes on the breakdown of polymers in a subtropical setting. Textural analyses suggest that polyethylene has the potential to degrade more readily than polypropylene.
Corcoran et al., 2009	Beach plastics feature both mechanically eroded and chemically weathered surface textures. The textural results suggest that plastic debris is particularly conducive to both chemical and mechanical breakdown in beach environments, which cannot be said for plastics in other natural settings.
DiGregorio, 2009	Polyhydroxyalkanoates (PHAs) are marine degradable whereas another alternative biodegradable product, polylactic acid (PLA), is not.

---

## DEGRADATION

### CITATION

### BRIEF SUMMARY

Harshvardhan et al., 2013

Sixty marine bacteria isolated from pelagic waters were screened for their ability to degrade low-density polyethylene; among them, three were positive and able to grow in a medium containing polythene as the sole carbon source.

Kershaw et al., 2011

The degradation time for plastic in the marine environment is, for the most part, unknown. Estimates are in the region of hundreds of years. Most types of plastic cannot be considered biodegradable in the marine environment.

Pegram et al., 1989

Several types of thermoplastic and latex rubber materials commonly encountered in marine plastic debris tended to weather at a slower rate when exposed in sea water compared to that in air. This retardation of weathering is probably a result of lack of heat build-up in samples exposed at sea.

Roy et al., 2011

It appears from the existing literature that our search for biodegradable polyethylene has not yet been realized.

Webb et al., 2009

Plastic debris causes extensive damage to the marine environment, largely due to its ability to resist degradation. Attachment on plastic surfaces is a key initiation process for their degradation. Heterotrophic bacteria were found to have suitable metabolic activity to survive in seawater while attaching to the PET plastic surface.

CONTAMINANTS	
REFERENCE	BRIEF SUMMARY OF FINDINGS
Andrady, 2011	Weathering degradation of plastics on the beaches results in their surface embrittlement and microcracking, yielding microparticles that are carried into water by wind or wave action. Unlike inorganic fines present in sea water, microplastics concentrate persistent organic pollutants (POPs) by partition. Microparticles laden with high levels of POPs can be ingested by marine biota.
Bakir et al., 2012	Plastics are known to sorb persistent organic pollutants from seawater.
Carson et al., 2013	The plastic degradation process may accelerate bacterial colonization leading to eventual sinking, or make the item more likely to be ingested, passing adsorbed persistent organic pollutants up the food chain.
Endo et al., 2013	The desorption kinetics of polychlorinated biphenyls (PCBs) from marine plastic pellets highly depends on the PE-water partition coefficients of PCB congeners.
Fisner et al., 2013	Plastic pellets may serve as a carrier of toxic contaminants, including polycyclic aromatic hydrocarbons (PAHs).
Fotopoulou et al., 2012	Eroded PE demonstrates an altered surface that at seawater pH acquires a negative charge due to ketone groups. The uneven surface and possible functional groups might explain the interaction of eroded plastics with microbes and metals.
Frias et al., 2011	Plastics are capable of adsorbing persistent organic pollutants (POP) which may be harmful for the marine environment and aquatic and terrestrial organisms that feed in nearby beaches.

CONTAMINANTS	
REFERENCE	BRIEF SUMMARY OF FINDINGS
Hirai et al., 2011	Hydrophobic organic compounds such as PCBs and PAHs were sorbed from seawater to the plastic fragments.
Kershaw et al., 2011	Microplastics are ubiquitous in the ocean, contain a wide range of chemical contaminants, and can be ingested by marine organisms. Potential chemical effects are likely to increase with a reduction in the size of plastic particles. Compounds used in the manufacture of plastics, such as nonylphenol, phthalates, bisphenol A (BPA) and styrene monomers, can have adverse health effects at high concentrations. This may include impacts on the endocrine system involved in regulating hormone balance.
Lee et al., 2013	Marine microplastics may play an important role in the global fate of POPs.
Mato et al., 2001	Plastic resin pellets serve as both a transport medium and a potential source of toxic chemicals in the marine environment.
Ogata et al., 2009	PCB concentrations in polyethylene pellets were highest on US coasts, followed by western Europe and Japan, and were lower in tropical Asia, southern Africa and Australia.
Rios et al., 2007	Plastic debris is a trap for POPs.
Saido et al., 2009	Drift plastic does indeed decompose to give rise to hazardous chemicals in the ocean.

---

## APPENDIX G – CONTACT LIST

---

Name	Organization
Alex Alimohammadi	Regional Water Quality Control Board - Los Angeles Region
Mary Barthomolew	Regional Water Quality Control Board - Santa Ana Region
Bob Benson	Environmental Protection Agency - Office of Wetlands, Oceans and Watersheds
Richard Boon	Orange County - Stormwater Program
Christine Boschen	Converge Forward Inc. (Formerly: San Francisco Regional Water Quality Control Board)
Carolynn Box	5 Gyres Institute
Eveline Bravo	Heal the Bay
Marsa Chan	City of Los Angeles - Bureau of Sanitation
Anna-Marie Cook	Environmental Protection Agency - Marine Debris Program
Bill Cooper	University of California, Irvine
Cheyenne Cummings	University of California, Dominguez Hills
John Decampos	EPS Industry Alliance
John Dorsey	Loyola Marymount University
Marcus Eriksen	5 Gyres Institute
Adam Fischer	Regional Water Quality Control Board - Santa Ana Region
Karen Flores	Friends of the LA River
Adam Furman	California State University, Fullerton
Joe Geever	Surfrider Foundation
Roland Geyer	University of California, Santa Barbara
Jolene Guerrero	County of Los Angeles - Department of Public Works



Name	Organization
Stephanie Hada	Regional Water Quality Control Board - Los Angeles Region
Hillary Hauser	Heal the Ocean
James Hawkins	Heal the Ocean
Ann Heil	Sanitation Districts of Los Angeles County
Basil Hewitt	Sanitation Districts of Los Angeles County
Bill Hickman	Surfrider Foundation
Kirsten James	Heal the Bay
Paul Jenkin	Surfrider Foundation
Colleen Lee	University of San Francisco
Sherry Lippiatt	National Oceanic and Atmospheric Administration - Marine Debris Program
Patty Long	Society of Plastics Industry
Alfredo Magallanes	City of Los Angeles - Bureau of Sanitation
Judith Marquez	Innovare Environmental
Charles McGee	Serves on Clean Beaches Task Force (formerly with Orange County Sanitation District)
Lara Meeker	LA Waterkeeper
Jim Merid	City of Huntington Beach
Jim Meyer	Trails4All
Shelly Moore	Southern California Coastal Water Research Project
Kristy Morris	Council for Watershed Health
Dana Murray	Heal the Bay
Jenny Newman	Regional Water Quality Control Board - Los Angeles Region

Name	Organization
Matthew O'Carroll	Universtiy of California, Santa Barbara - Facilities Management
Ann Marie Ore	State Water Resource Control Board
Frankie Orrala	Heal the Bay
Danny Pham	Regional Water Quality Control Board - San Francisco Bay Region
Pete Reich	Environmental Protection Agency - Marine Debris Program
Anthony Rodrigo	PEXCO / All West Plastics
Carlos Santos	Regional Water Quality Control Board - Los Angeles Region
Dylan Seidner	State Water Resources Control Board - California
Sarah Sikich	Heal the Bay
Nancy Steele	Council for Watershed Health
Hamid Tadayon	City of Los Angeles
Nicholas Tyack	Formerly: Friends of the LA River
Jon Van Rhyn	County of San Diego
Ted Von Bitner	AMEC Environment & Infrastructure (Formerly: Orange County – Dept. of Public Works)
Nancy Wallace	National Oceanic and Atmospheric Administration
John "Alan" Walti	Surfrider Foundation - South Bay Chapter
Dave Weeshof	International Bird Rescue Research Center in San Pedro
Daniel Sharp	County of Los Angeles - Department of Public Works
Grant Sharp	Orange County Public Works - Watersheds Division
Robert Rodarte	Orange County Public Works - Watersheds Division

## APPENDIX H – DATA INDEX

TITLE	DATE	SOURCE	BRIEF DESCRIPTION
Bight Study 2009-2012 Debris Data (Bight '13)	2009-2012	Southern California Coastal Water Research Project (SCCWRP). (2012). Bight 2009-2012 Debris Study. Costa Mesa, CA: SCCWRP.	Trash characterization study.
Clean Water Act, Section 303(d) List for California	2010	California State Water Resources Control Board (2010).	Derived from EPA's 2010 List of water bodies designated as impaired under the Clean Water Act.
IEC Database	2013	National Oceanic & Atmospheric Administration (NOAA). (2013). Industrial Economics, Inc. (IEc).	Beach trash characterization study conducted in Orange County.
Long Beach Trash Cleanup on Beaches	2002-2003	Charles Moore.	Study of trash collected off Long Beach's shoreline.
Los Angeles River Trash Boom	2000-2013	County of Los Angeles Department of Public Works. Flood Maintenance Division, South Area.	Trash characterization of debris collected from behind the trash boom on the Los Angeles River.
Los Angeles River Trash TMDL Compliance Reports Summary	2012	Los Angeles Regional Water Quality Control Board.	Los Angeles River Watershed Trash TMDL compliance reports for 41 cities.

TITLE	DATE	SOURCE	BRIEF DESCRIPTION
Plastic Facility Industry Survey	2009	State Water Resources Control Board.	Industry survey of plastic facilities conducted to assess the handling of preproduction plastic raw materials.
Plastics Production & Manufacturing Facilities in Huntington Beach	2013	City of Huntington Beach.	SIC Codes and physical site inspections used to generate this list of industries that use plastics in their processes.
Stormwater Permitted Industrial Plastic Facilities. Los Angeles Regional Water Quality Control Board (Los Angeles Watershed)	2013	Los Angeles Regional Water Quality Control Board. Online database.	List of stormwater-permitted plastic facilities in the Los Angeles Watershed identified by SIC codes.
Stormwater Permitted Industrial Plastic Facilities. Santa Ana Regional Water Quality Control Board (San Gabriel Watershed)	2013	Santa Ana Regional Water Quality Control Board. Online database.	List of stormwater-permitted plastic facilities in the San Gabriel Watershed identified by SIC codes.
Southern California Stormwater Monitoring Coalition Sites (Years 3 to 5)	2013	Orange County Public Works – Watersheds Division.	Google Earth map and descriptions of trash study sites conducted by the SMC.

---

# APPENDIX I – STATE WATER RESOURCES CONTROL BOARD PLASTIC FACILITIES SURVEY SUMMARY

---

## SUMMARY OF RESULTS

---

- More than half (54%) use preproduction plastic materials in either pellet, resin, or powder form.
- High and low density polyethelene make up the majority of polymers used.<sup>1</sup>
- The industry is dominated by small volume processors.
- Polyvinyl chloride (PVC) is the most commonly used polymer, followed by polystyrene (PS) and high density polyethelene (HDPE).
- Common spills occur under or near processing equipment, followed by areas where hoppers or silos are filled or emptied.
- Routine operational spills are cleaned frequently.
- Accidental spills occur infrequently.
- The most commonly cited cause of accidental spills was loading, unloading, and handling procedures.
- The majority of facilities have outdoor loading docks and indoor hoppers and silos.
- Truck freight is the most common form of material delivery and shipments mainly occur multiples per week.
- Gaylord or bulk boxes are the most common form of material packaging.
- Packages arrive broken or leaking less than once per year.
- Packages are broken or spilled during handling or unloading at the facility less than once per year.
- The connection of vacuum feed lines to hopper cars rarely causes material leakage.
- The top common spill prevention and response procedure was cited as immediate cleanup.
- There is very low Operation Clean Sweep participation.
- The majority of materials are recycled.
- The most commonly implemented BMPs/GMPs are routine housekeeping and immediate cleanup, the use of a broom for cleanup, employee training on release prevention measures, the use of a vacuum for cleanup, and employee education on the environmental hazards of the materials.

---

<sup>1</sup> 47% of respondents used the “other” category – suggesting that there are other polymer types that could have been included in the choices

- 
- Routine cleanup is considered the most effective BMP/GMP, followed by employee training and awareness, and routine inspections.
  - Mat installations to prevent tracking material outdoors are considered the least effective BMP/GMP, followed by alarm alerts when spills occur.
  - More than two-thirds implement containment systems designed to prevent material discharge into storm drains or waterways.
  - Plastic is designated as a pollutant in the majority of Storm Water Pollution Prevent Plans.



---

# SURVEY RESPONSE ANALYSES

---

The survey was circulated to 655 selected facilities<sup>2</sup> on October 14, 2009. A total of 438 valid responses were received, representing a 67% response rate. Out of these respondents, 54% reported that their business involved the handling of pre- or post-production plastic. The first four questions were for preliminary information gathering (i.e., business name, address, contact, etc.) and are not analyzed here. All results reported below are only for those respondents that indicated they handled pre- or post-production plastic.

**Survey Questions & Results (all results are reported as a percentage of total valid responses)**

**5. Is your business involved with the production, manufacture, transportation, handling, packaging, storage, warehousing, processing, or generation of the following: Preproduction resins in pellet, powder, granule or flake form; Resin additives in pellet, powder, granule or flake form; Plastic recycle materials including regrind and recycled resin pellet formats; Plastic scrap from production processes?**

Response	Percentage
Yes	54%
No	46%

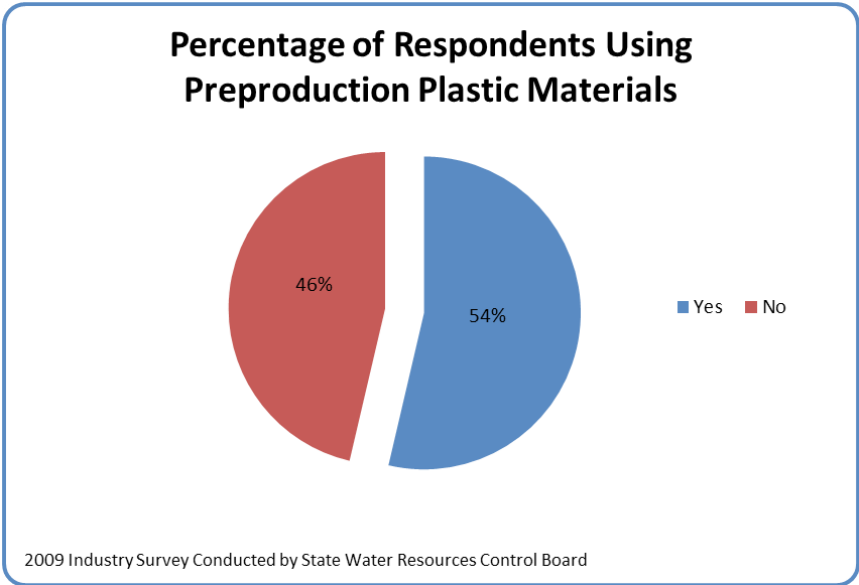

---

<sup>2</sup> State Water Board staff developed a list by selecting facilities from the Industrial General Permit with plastics industry-related SIC codes.

**6. What forms of PPPP are involved with your business? (Check multiple answers if necessary)**

Response	Percentage
Preproduction resin in pelletized form	63%
Generation of plastic scrap (for example, shavings generated from tooling or assembling plastic products)	51%
Post-industrial regrind or recycling	49%
Preproduction resin or powder additives (including coloring)	36%
Preproduction resin in granule, flake, or other form	26%
Preproduction resin in powder form	17%
Other form of resin, additive, or plastic (please specify)	15%

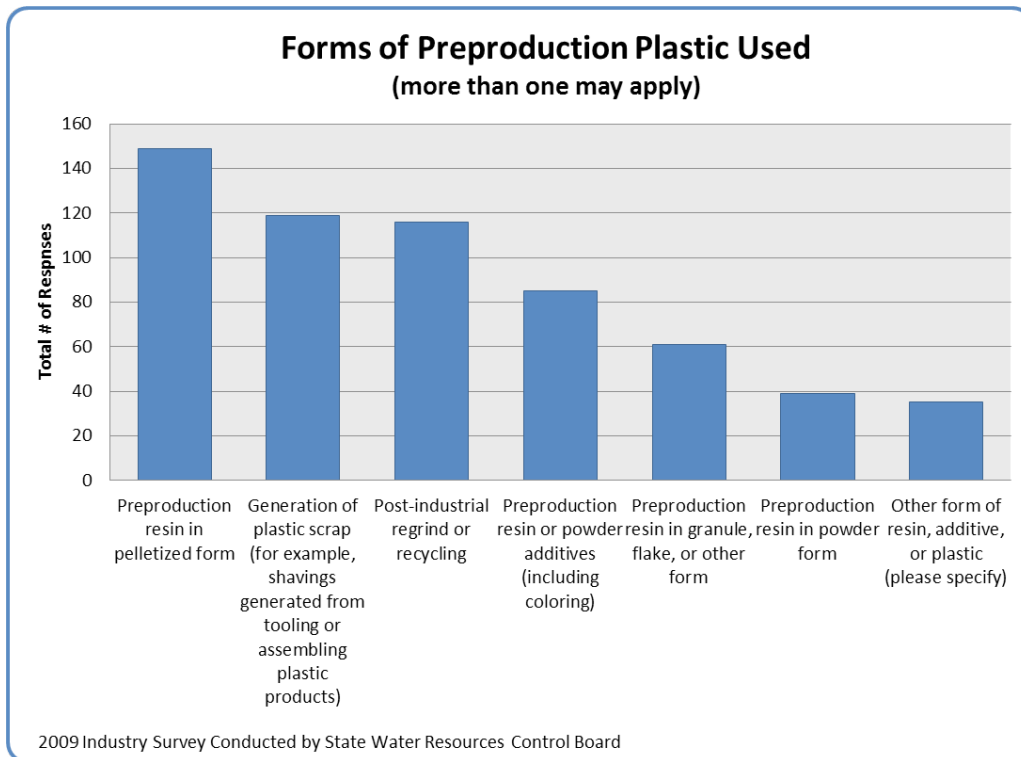

7. What types of polymers are used at your facility? (Check multiple answers if necessary)

Response	Percentage
Other (please specify)	47%
High density polyethylene - HDPE	43%
Low density polyethylene - LDPE	34%
Polypropylene - PP	31%
Polystyrene - PS	29%
Polyvinyl chloride - PVC	28%
Polyethylene terephthalate - PET	13%

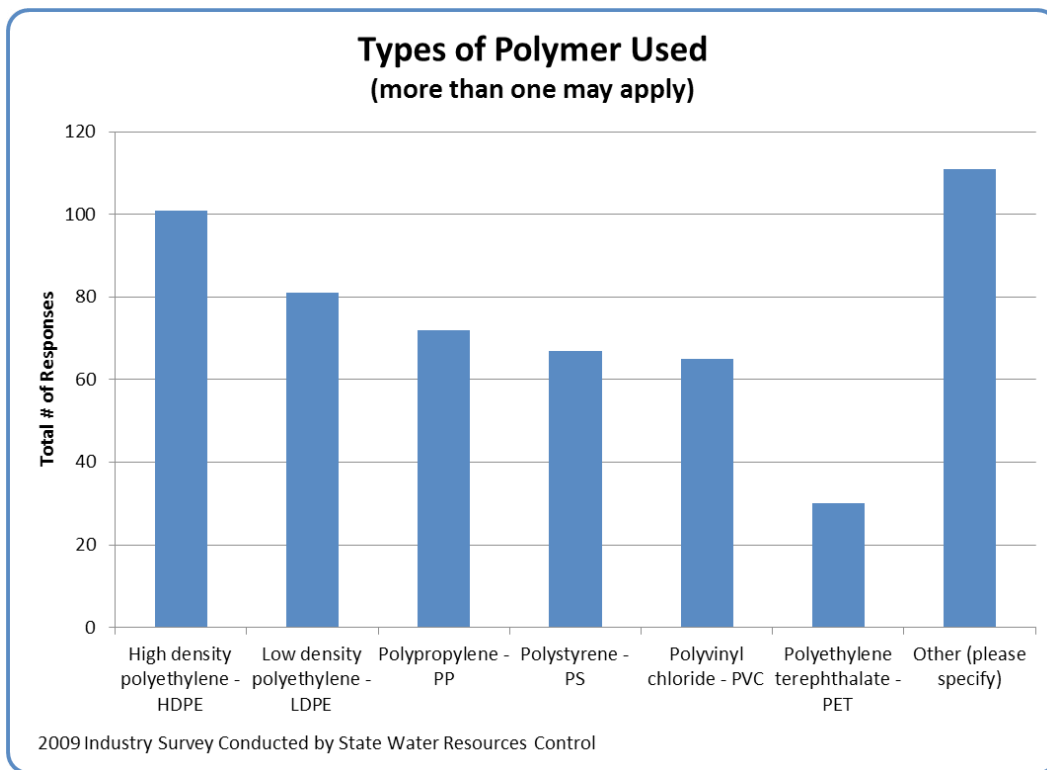

**8. For each polymer indicated in Question 7, approximately how many pounds of it are processed or produced at your business per year? If your business generates or recycles plastic scrap, estimate lbs/year of scrap sold, disposed, or recycled. If your business is using multiple formats or types of PPPP, use a separate line for each one.**

A total of 206 valid responses were received to this open-ended question (88%). Many respondents failed to break out their responses by each polymer as requested. To address this, the total volume reported was included in the "Other" category. There was apparently some confusion with respect to the second part of this question related to recycling of materials. Only 31% of the 206 valid responses responded to the second part of this question. Out of this 31% many reported the total volume recycled, but not the amount sold. Based on these results, only the responses to the first part of the question relating to volumes processed are discussed below.

There are several ways the responses to the first part of the question could be interpreted. The average volumes for each of the designated polymers are listed below. The responses to the Other (please specify) section varied substantially, making quantification difficult.

Response	Average (millions of pounds)
Polyvinyl chloride - PVC	3.4
Polystyrene - PS	2.0
High density polyethylene - HDPE	1.9
Polyurethane (PU or PUR)	0.1
Other (please specify)	1.5
Polyethylene terephthalate - PET	0.9
Low density polyethylene - LDPE	0.6
Polypropylene - PP	0.4

The chart below reflects the total volume, by polymer, produced or processed per year for all of the respondents.

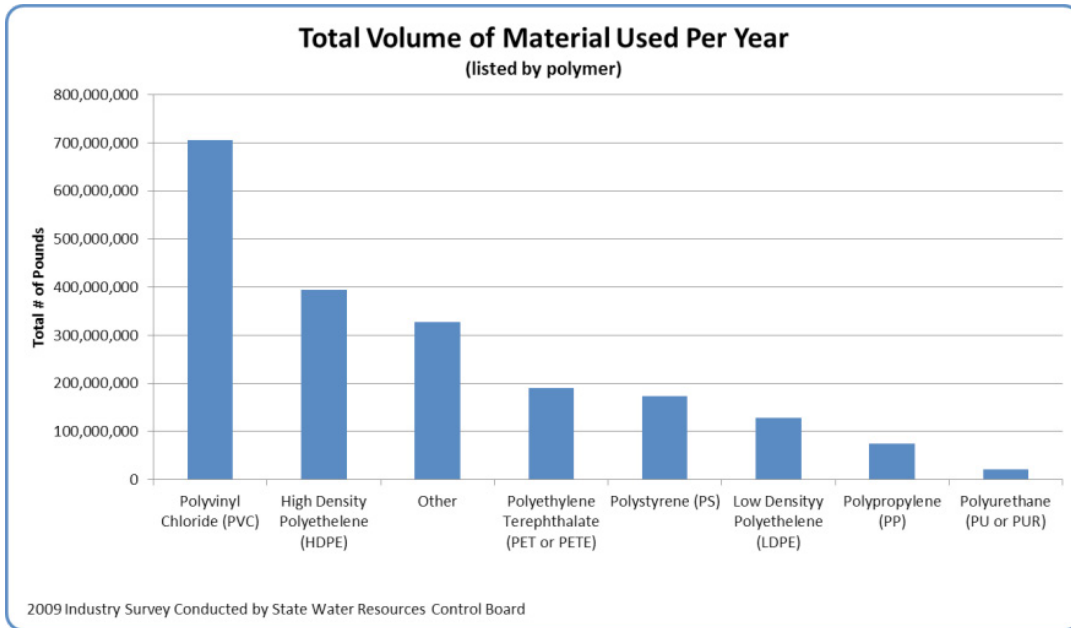

What can also be derived from these responses is the overall makeup of the industry as a whole (in terms of production/processing volume), which is dominated by small volume facilities (less than 1 million pounds of raw materials produced or processed per year).

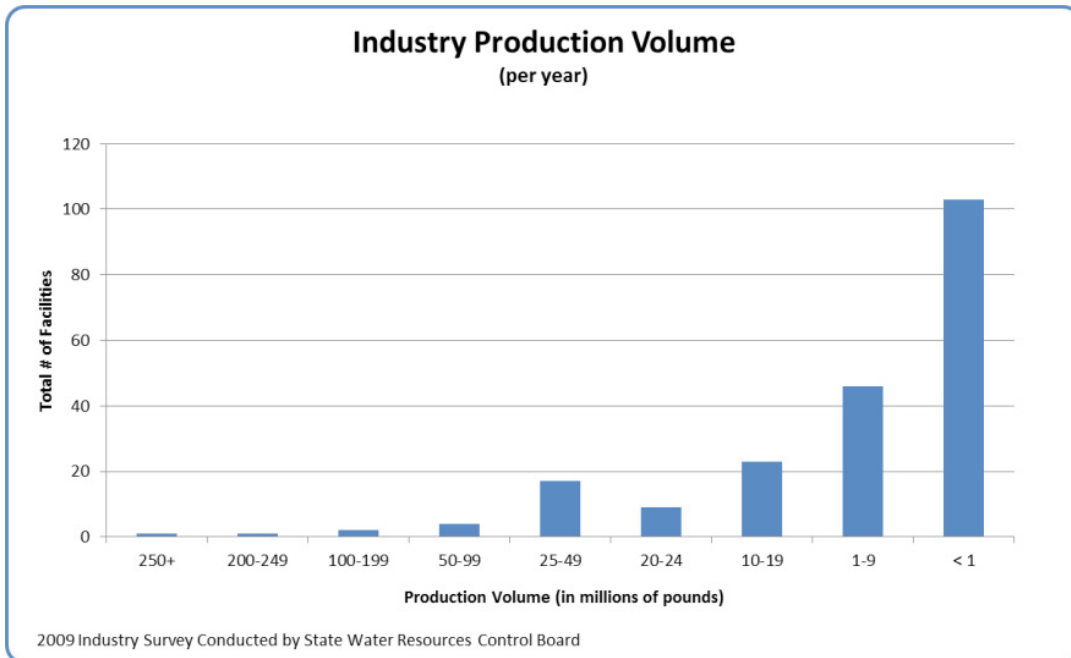

9. How would you primarily categorize your business?

Response	Percentage
Processor	83%
Producer	11%
Recycler	3%
Transporter and/or Contract Packer	2%

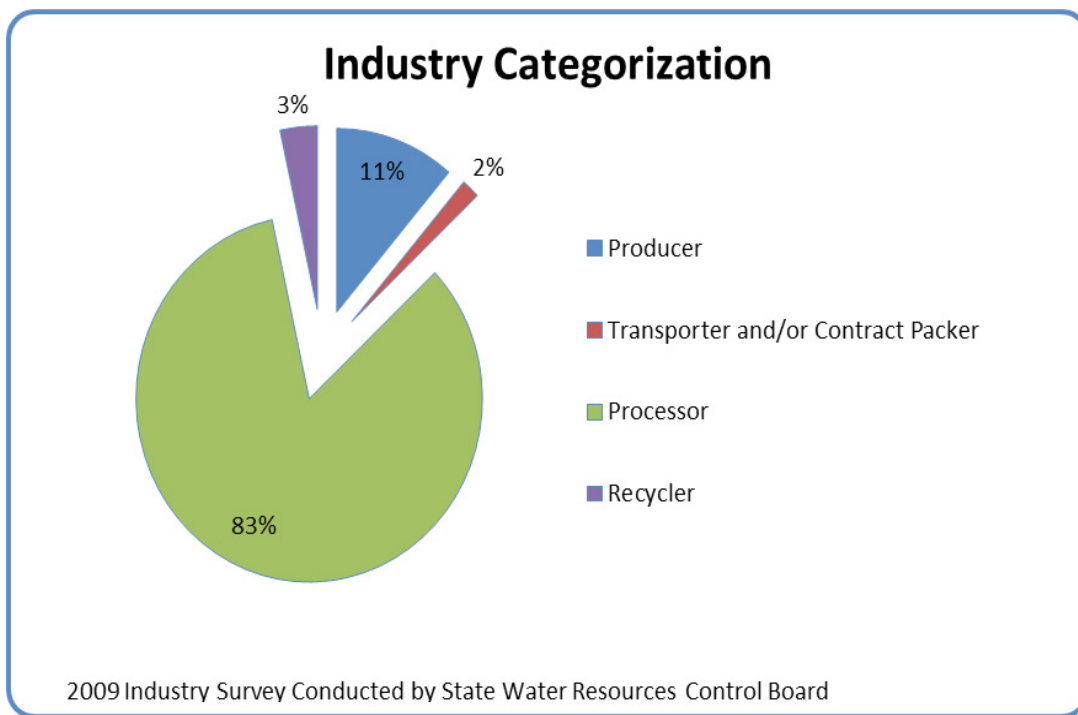



**10. What are some common areas where spills are expected to occur as part of routine operations? (Check multiple answers if necessary)**

Response	Percentage
Under or near processing equipment	57%
Areas where hoppers or silos are filled or emptied	43%
Areas where recycling or regrind is processed	41%
Areas where PPPP is stored	36%
Truck loading areas	32%
Rail or hopper car loading areas	20%
Areas where PPPP is conveyed	14%
Other areas (please specify)	----

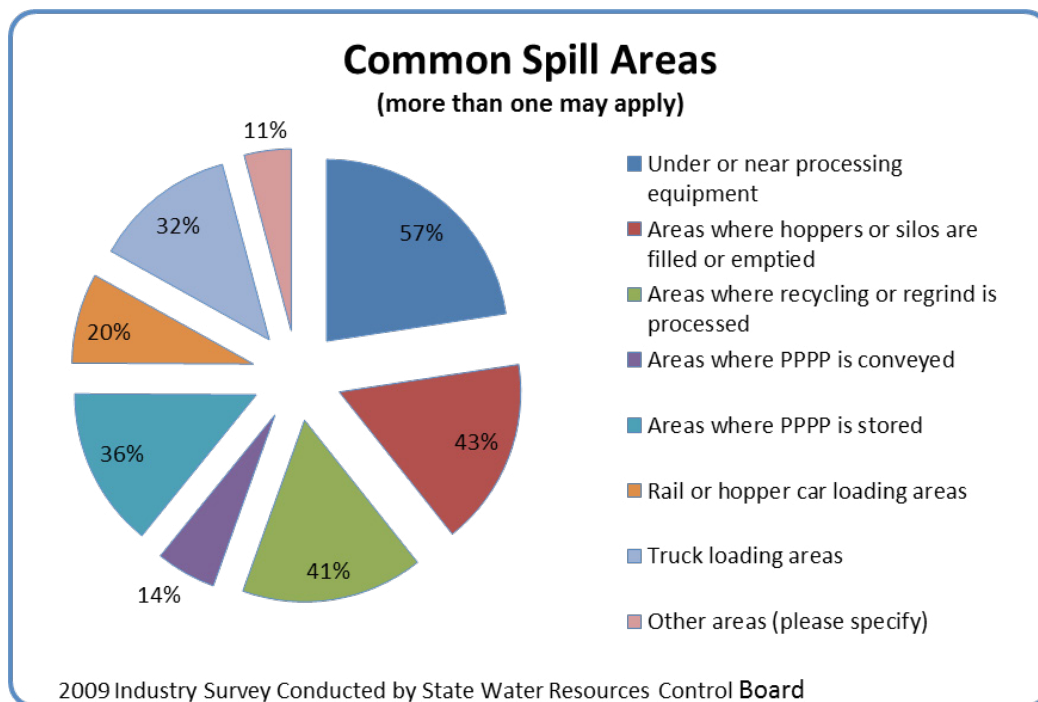

11. Approximately how often are these routine operations spills of PPPP cleaned? If the answer is "as necessary" estimate number of times necessary on the scale.

Response	Percentage
1-5 times per day	33%
1 - 4 times per week	22%
Once a month	14%
Once a week	12%
Never	9%
5 or more times per day	7%

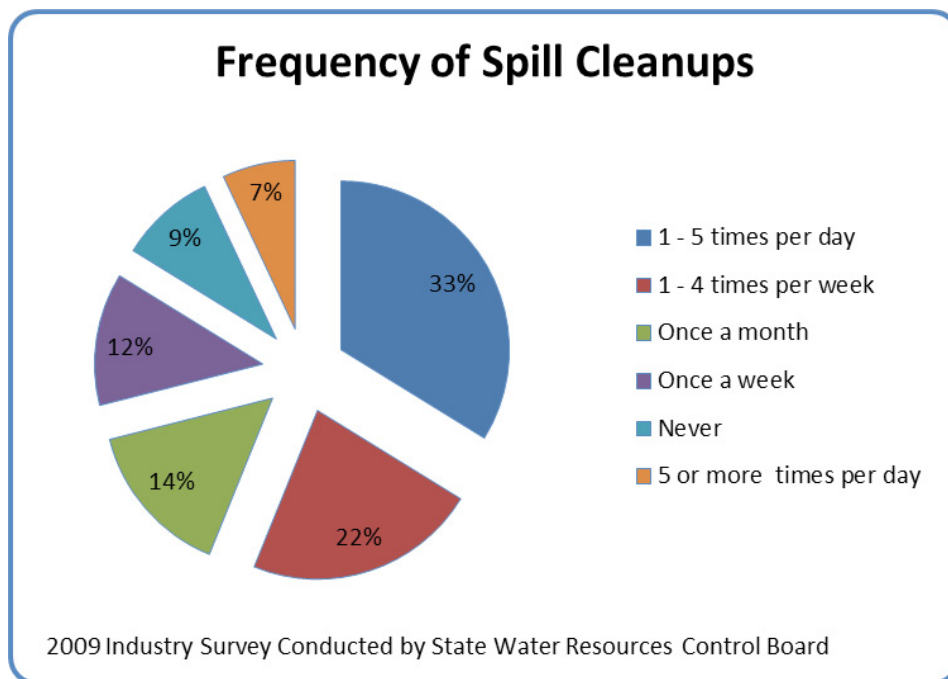

12. How frequent would you say that accidental PPPP spills occur at your facility? For example, a spill that occurs due to an overfilled silo, batch testing of PPPP, leaks during vacuum line connection, broken equipment, employee error, etc.

Response	Percentage
1 -4 times per year	48%
Never	18%
Daily or weekly occurrence during normal operations	13%
5 - 12 times per year	11%
12 - 24 times per year	6%

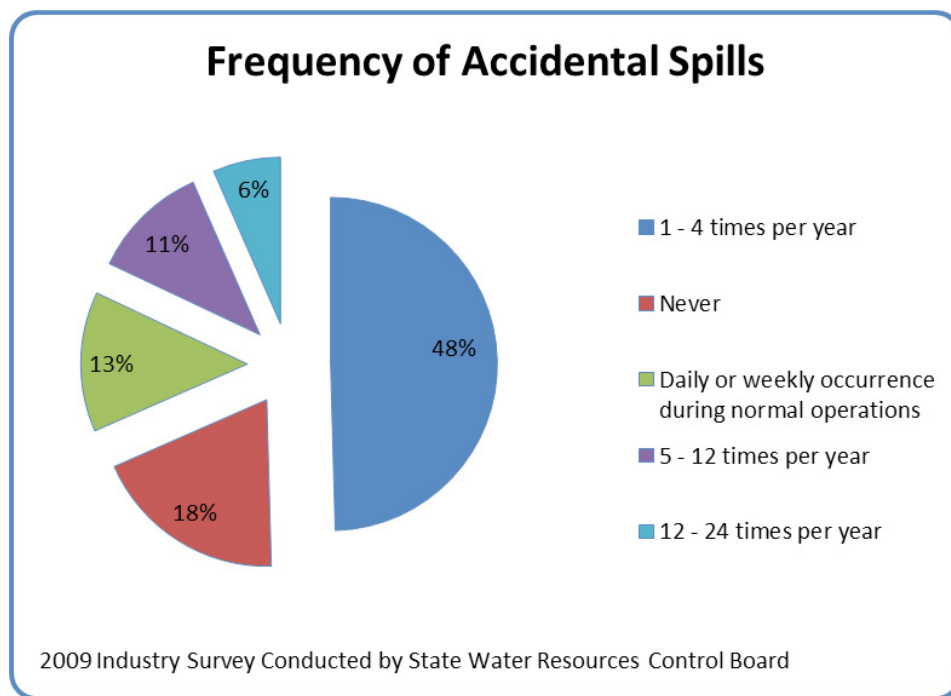

13. What would you consider the cause of accidental spills of PPP at your facility? (Check multiple answers if necessary)

Response	Percentage
Loading, unloading, and handling procedures	49%
Damaged or leaking packaging	36%
Employee error or lack of awareness	33%
Other (please specify)	18%
Equipment error	16%
Lack of secondary containment	2%

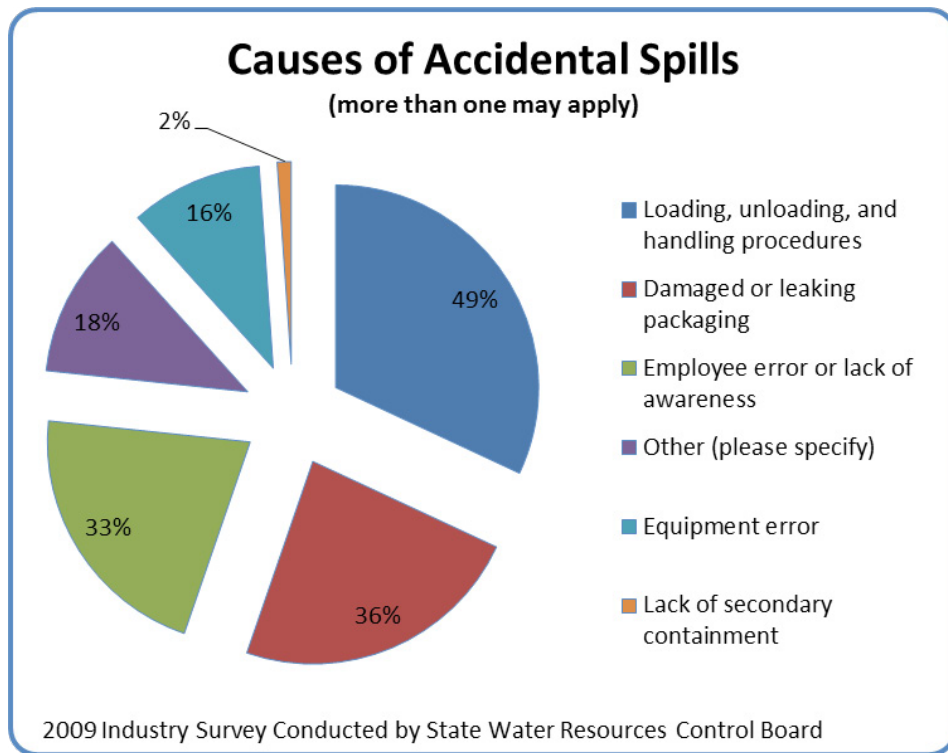

14. Does your facility have any of the following? (Check multiple boxes if necessary)

Response	Percentage
Outdoor loading docks	58%
Indoor hoppers and silos	54%
Outdoor hoppers and silos	38%
Indoor or enclosed loading docks	33%
Rail car staging or delivery area	26%

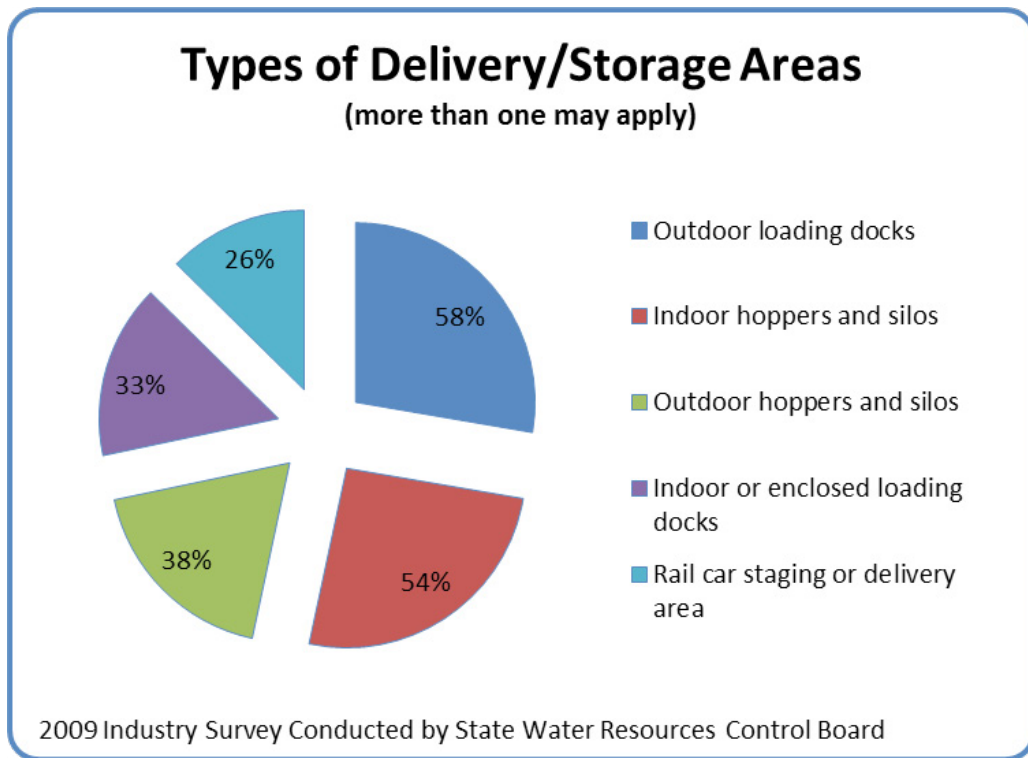

**15. How are PPPP delivered to or shipped from your facility? (Check multiple boxes if necessary)**

Response	Percentage
Truck freight	77%
Truck hopper	31%
Super sacks	26%
Train hopper	20%
Package delivery service (for example, FedEx or UPS)	19%
Other (please specify)	9%
Train freight	5%
Nurdles are not delivered, they are produced in-house	0%

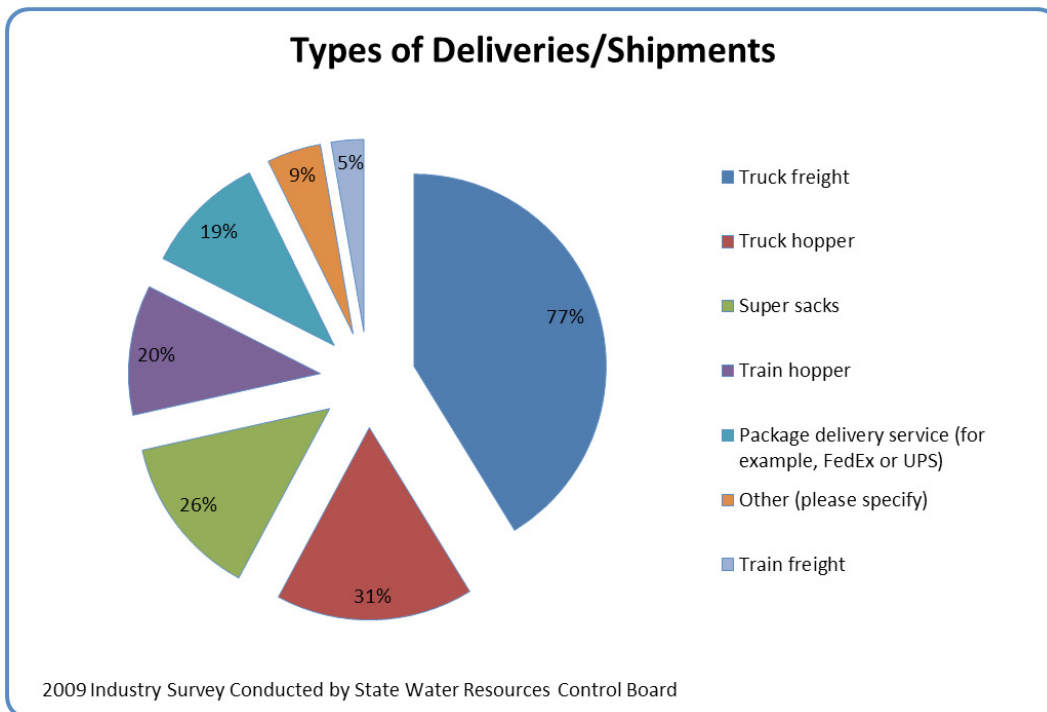



**16. How are PPPP packaged when delivered to your facility? (Check multiple boxes if necessary)**

Response	Percentage
Gaylord / Bulk boxes	54%
Small cardboard boxes or bags (100 lbs or less each)	38%
Bulk bags / Super sacks	29%
Hopper truck	24%
Hopper rail car	17%
Bags (100 lbs or less each)	0%
Combination of a bags and cardboard boxes (100 lbs or less each)	0%
Palletized boxes or bags	0%
Other (please specify)	----

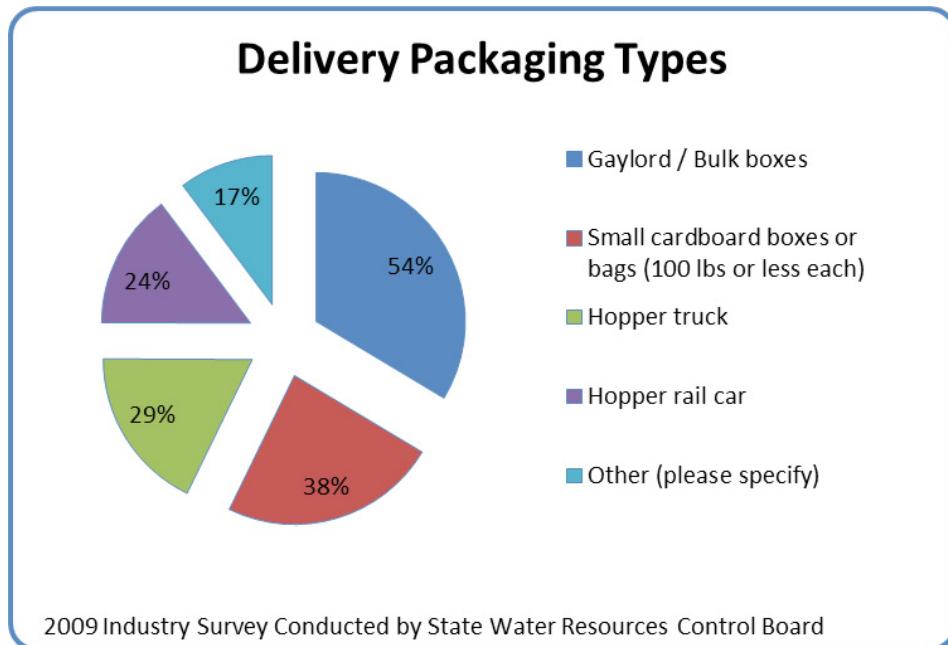

17. On average, how often do shipments of PPP occur to or from your facility?

Response	Percentage
Multiple times per week	36%
2-3 times per month	16%
Multiple times per day	12%
Once a week	11%
Once a month	10%
1-4 times per year	8%
Once a day	7%
Once a year	1%

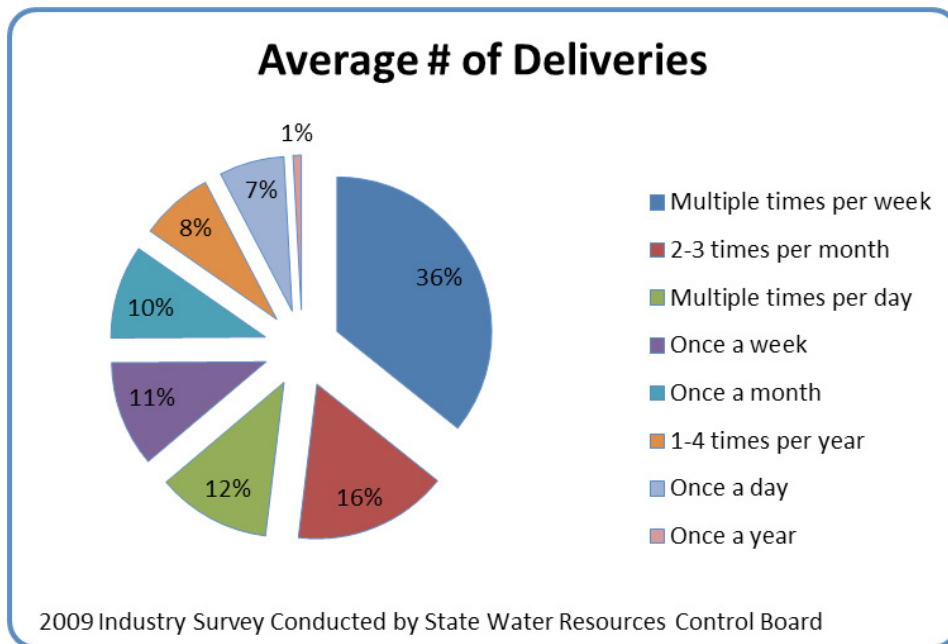

18. Approximately how often does a shipping container or bulk package arrive broken or leaking at your facility. Include leaks or breaks in rail or truck hoppers.

Response	Percentage
Less than once per year	65%
1 - 5 times per year	27%
6 - 11 times per year	4%
12 - 24 times per year	2%
Daily or weekly	1%

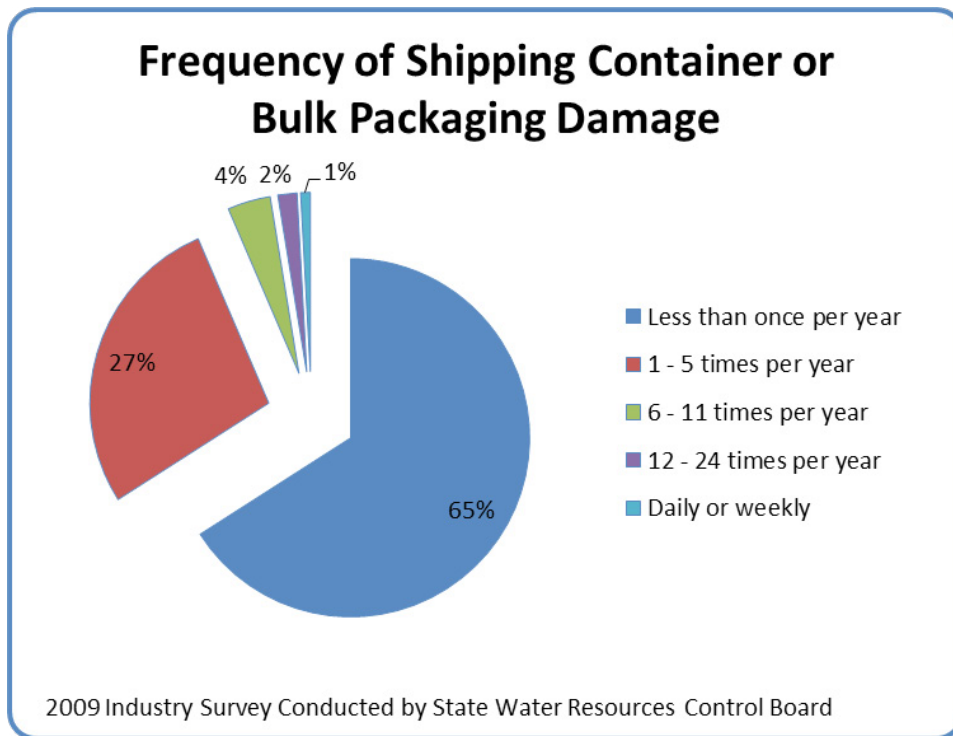

19. Approximately how often does a broken package or spill occur during shipping and receiving due to an accident in handling or unloading at your facility?

Response	Percentage
Less than once per year	60%
1 - 5 times per year	34%
12 - 24 times per year	3%
6 - 11 times per year	2%
Daily or weekly	0%

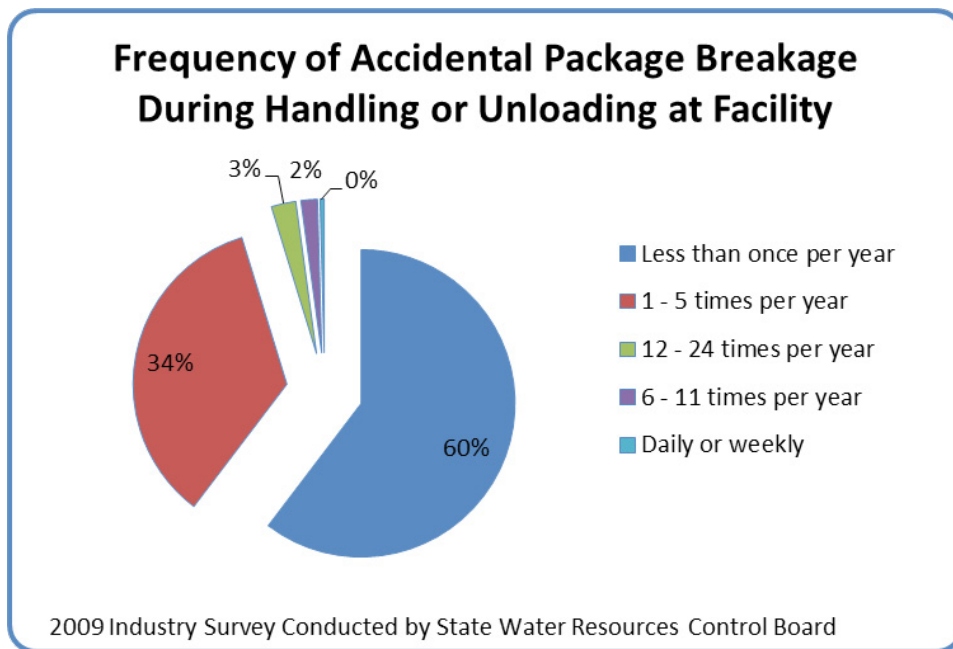

---

20. When connecting vacuum feed lines to hopper cars does leakage of PPPP regularly occur at the connection point or breather?

Response	Percentage
Not applicable	56%
No	31%
Yes	11%

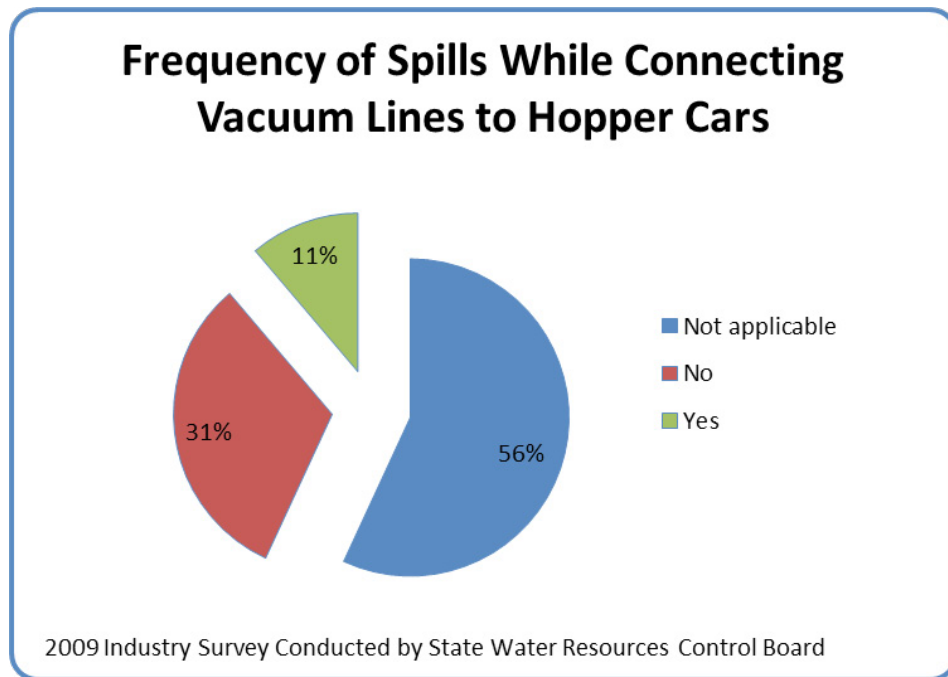

---

**21. What are the general procedures for spill prevention and response during shipping and unloading at your facility?**

A total of 221 valid responses were received to this open-ended question (94%). While the responses varied to some degree, there were some general trends in the answers which were assigned to a total of 12 categories. More than one response may apply.

Response	Percentage
Immediate Cleanup	71%
Spill Prevention	28%
Procedural Manuals / Employee Training	24%
Secondary Containment (liners, trays, etc.)	19%
Spill Containment and/or Stormdrain Discharge Prevention	14%
Routine Cleanup	11%
Container Inspections	10%
Spill Response Plan	8%
Spill Kits and/or Spill Stations	6%
Forklift Operator Procedures / Certification	5%
Refuse Damaged Containers	2%
Other	2%



The top six general procedures are ranked in the chart below.

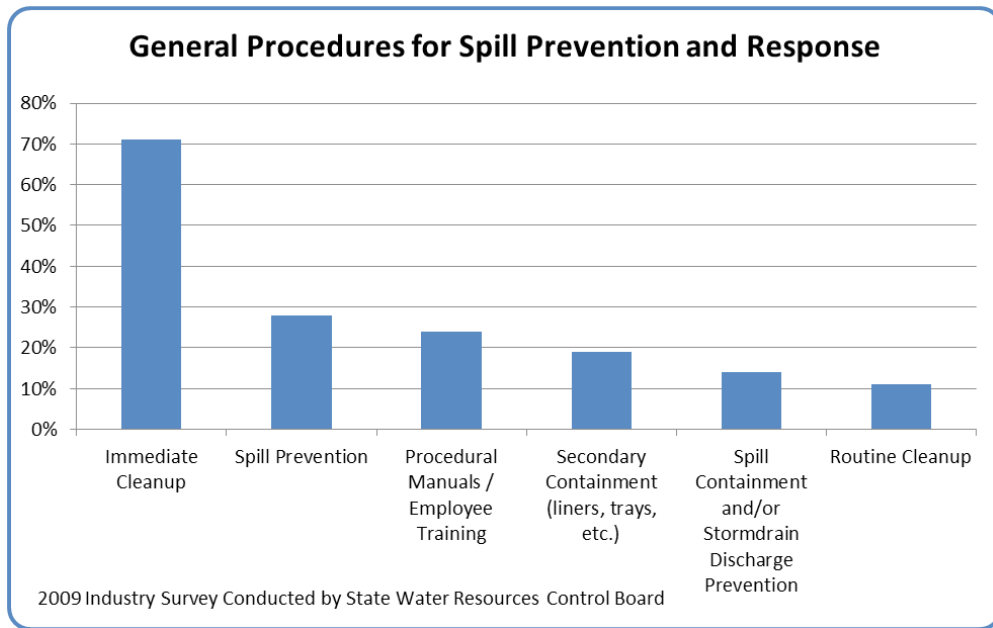

**22. To your best available knowledge, please identify the specific receiving waters that collect storm water discharges from your facility: List more than one answer if necessary.**

The responses to this question were nearly all invalid due to an apparent misunderstanding of the wording. Many respondents recorded MS<sub>4</sub>s in the surface water body column and vice versa. There were also references to discharges directly to the Pacific Ocean. For this reason, the responses to this question were not analyzed further.

Response	Percentage
Municipal separate storm sewer system (MS <sub>4</sub> s): small (e.g. City of Los Angeles MS <sub>4</sub> , County of Sacramento MS <sub>4</sub> )	---
Surface water bodies: small (e.g. specific drainage channel, river, creek, lake, etc.)	---

---

**23. Are you currently Operation Clean Sweep Pledge Partner?**

Response	Percentage
No	86%
Yes	13%

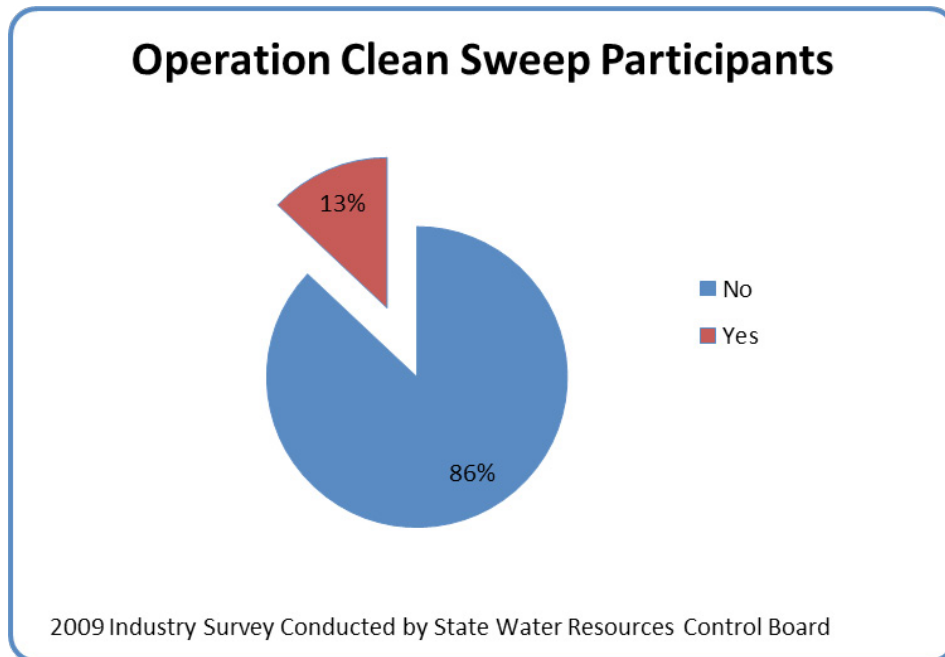

**24. How is PPPP disposed when it is cleaned up?**

Response	Percentage
Majority is recycled (either in house or sold)	43%
Some can be recycled, some must be disposed as trash	33%
Majority must be disposed as waste	15%
Other (please specify)	8%

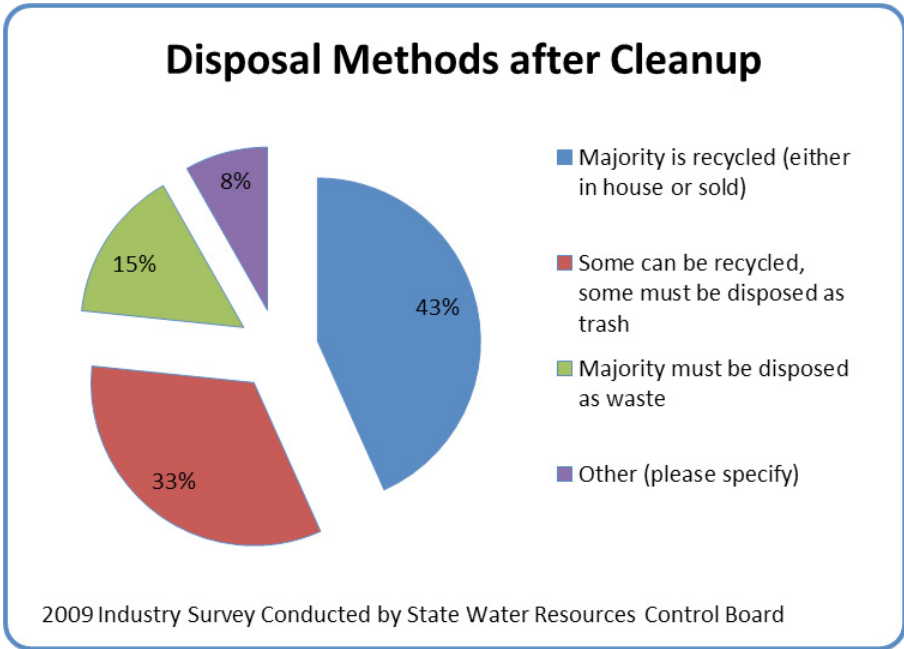

**25. What are some of the most commonly implemented best management practices (BMPs) or good manufacturing practices (GMPs) at your facility to prevent release of PPPP to the environment? (Choose multiple answers if necessary)**

Response	Percentage
Requiring routine housekeeping and immediate clean-up procedures	94%
Use of a broom for clean-up	89%
Employee training in PPPP release prevention measures	76%
Routine inspections for loose pellets on the facility grounds	76%
Use of a vacuum for clean-up	63%
Employee education on the environmental hazards of PPPP release	56%
Installation of secondary containment pans or screens to catch PPPP	45%
Checks and cleaning to ensure trucks and trains enter and leave the facility free of spilled PPPP	43%

Response	Percentage
Installation of containment systems or screens to prevent PPP discharge into storm-water or sewer drains	42%
Securing of outlet caps and seals on hoppers and hopper cars after unloading is complete	32%
Checks for loading systems and transfer lines to assure they are empty when loading ceases	28%
Installation of mats for wiping feet so PPPP is not transferred outdoors	23%
Screens or secondary containment at loading docks or rail staging areas	22%
Sealing of expansion joints in the floor or cracks in the parking lot to eliminate PPPP collection contour	18%
Other (please specify)	10%
Alarms that alert operators when PPPP may be released	6%

The top six commonly implemented BMPs/GMP's are ranked in the chart below.

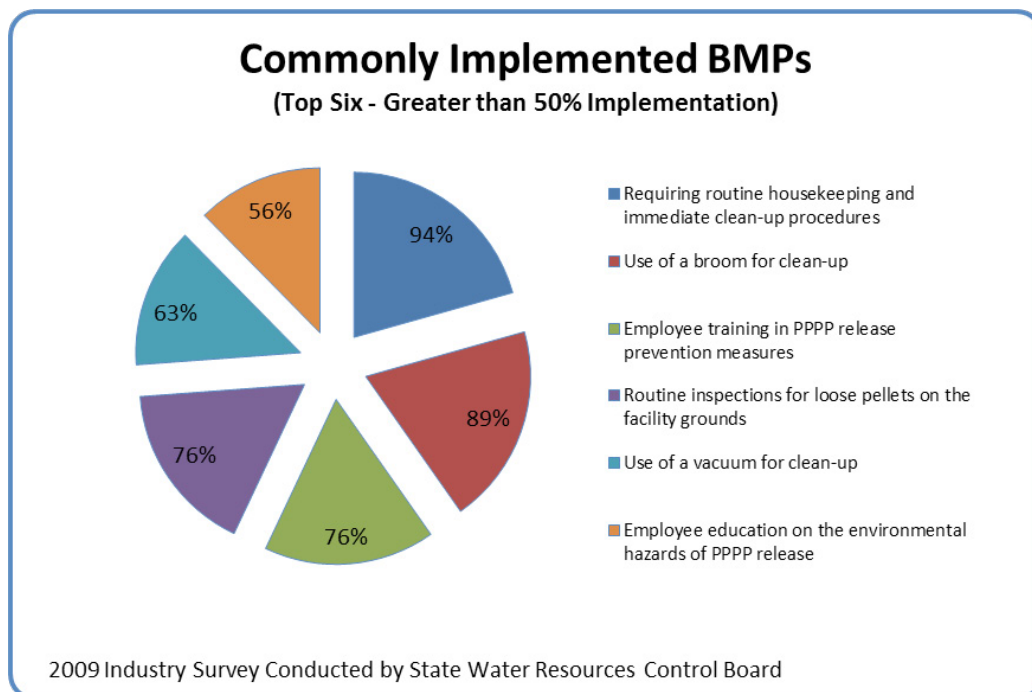

---

**26. What would you consider the most effective BMPs or GMPs for your facility?**

A total of 224 valid open responses were received to this open-ended question (95%). While the responses varied to some degree, there were some general trends in the answers which were assigned to a total of 10 categories. More than one response may apply to the total percentages reported.

Response	Percentage
Routine Cleanup	50%
Employee Training & Awareness	40%
Routine Inspections	33%
Immediate Cleanup	25%
Secondary Containment	20%
Spill Prevention	10%
Proper Loading / Unloading Procedures	5%
Other	4%
Indoor-Only Handling	3%
Refuse Damaged Containers	0%

The top six most effective BMPs/GMPs from this survey are ranked in the chart below.

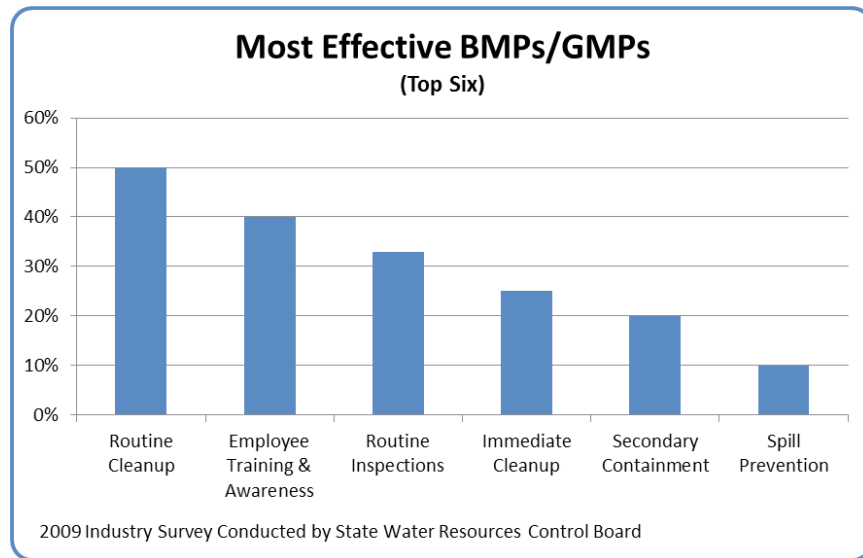

## 27. What would you consider the least effective BMPs or GMPs for your facility?

There was a great degree of misinterpretation of this open-ended question. Some respondents cited problems they face in addressing the problem of spills (i.e., difficulty in engaging employees on the need for proper handling of the materials), rather than ineffective BMPs/GMPs. It should also be noted that some respondents also took this opportunity to “complain” about the Water Board’s site inspections, BMP requirements, and the overall cost of program compliance.

A total of 144 valid responses were received to this question (61%). Again, while the responses varied to some degree, there were some general trends in the answers which were assigned to a total of 10 categories. More than one response may apply. Many respondents (35%) indicated that all BMPs/GMPs were effective, at least to some degree.

Response	Percentage
All BMPs are effective	35%
Mat installations to prevent tracking material outdoors	9%
Alarms to alert of material spills	8%
Broom cleanups	7%
Employee Training & Awareness	6%



Response	Percentage
Surface area treatments of cracks and joint sealing of concrete and asphalt surface areas	6%
Routine inspections	6%
Secondary containment	5%
Having no BMPs	4%
Storm drain screens	4%
Waterboard site inspections and/or the stormwater prevention program	3%
Reactive versus proactive BMPs	3%
Spill prevention	2%
Solid waste disposal of materials	2%
Vacuum cleanups	1%
Routine housekeeping	1%
Reliance on shippers for spill prevention and/or cleanup	1%

The top six least effective BMPs/GMPs from this survey are ranked in the chart below.

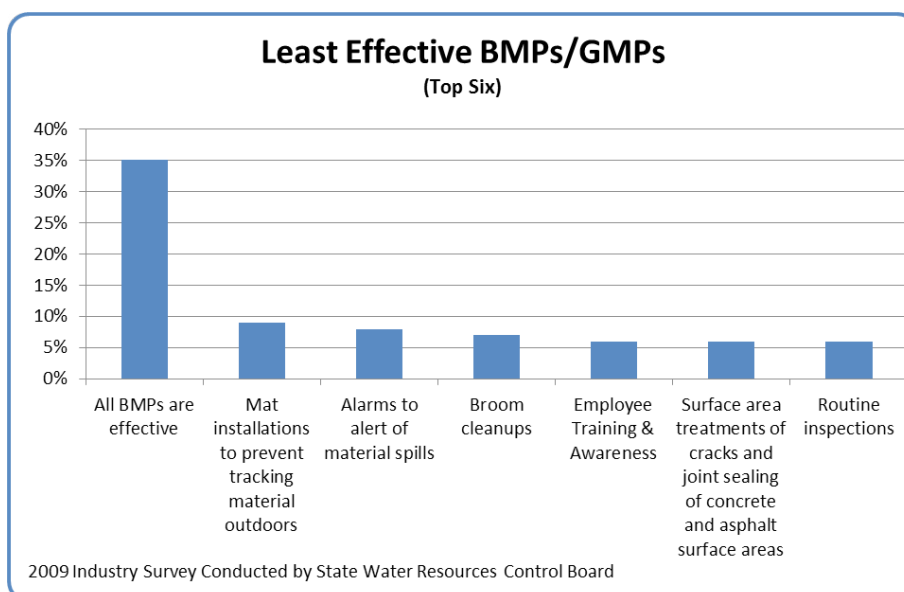

---

28. Does your facility implement containment systems that are designed to prevent PPPP discharge into storm drains or waterways?

Response	Percentage
Yes	69%
No	29%

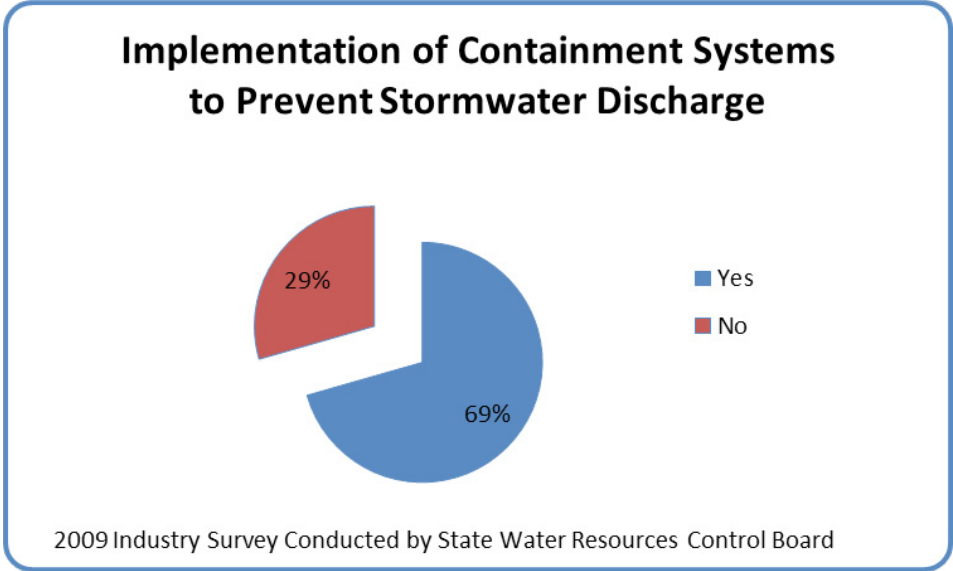

---

29. Does your facility's Storm Water Pollution Prevention Plan (SWPPP) specifically include PPPP as a potential gross pollutant for stormwater? Or, does your SWPPP include BMPs to reduce or prevent PPPP in stormwater discharges?

Response	Percentage
Yes	79%
No	19%

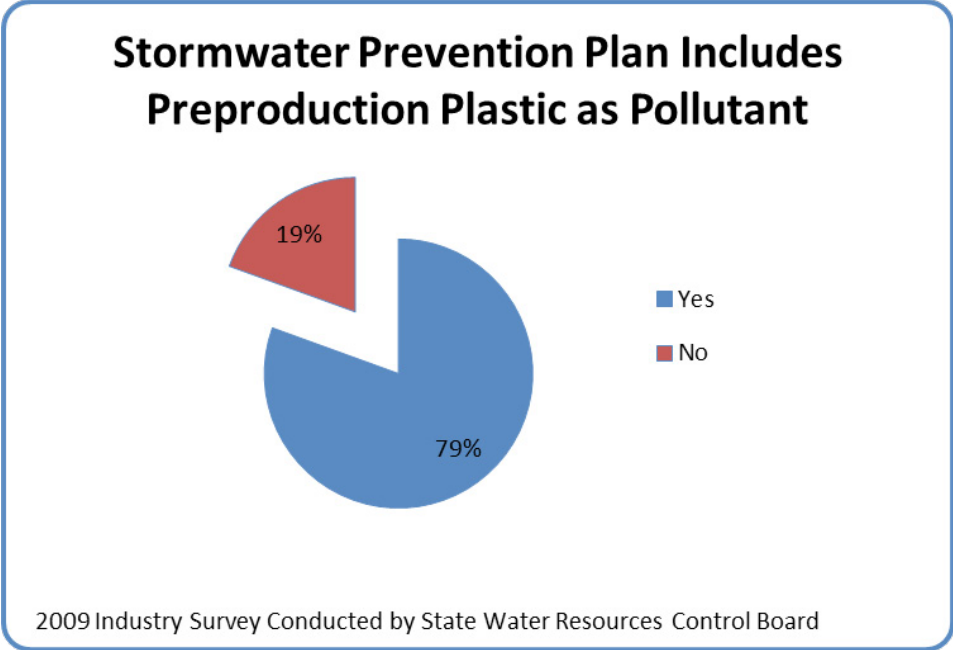

---

30. Does your facility have a program to track PPPP percent yield vs percent scrap per year?

Response	Percentage
No	58%
Yes	40%

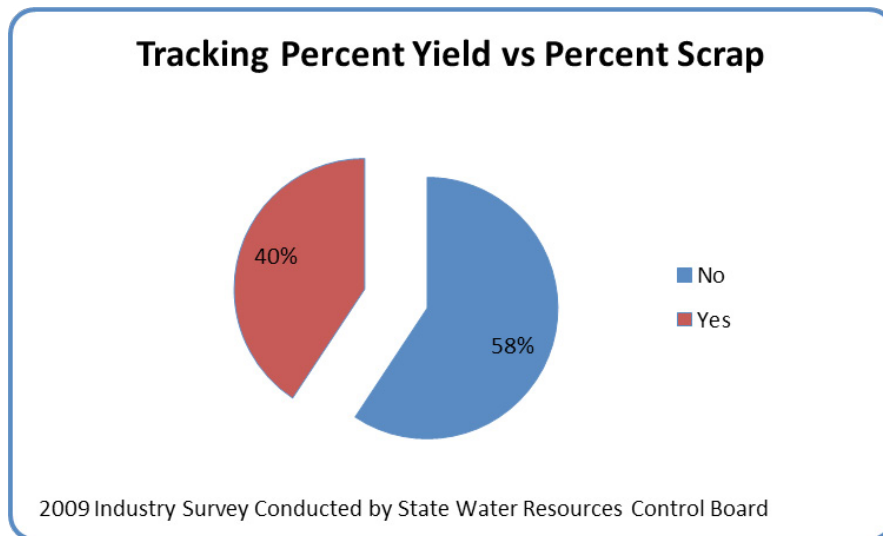

---

31. Would you be interested in receiving more information about PPPP specific housekeeping and containment practices that could be applied to your facility?

Response	Percentage
Yes	76%
No	23%

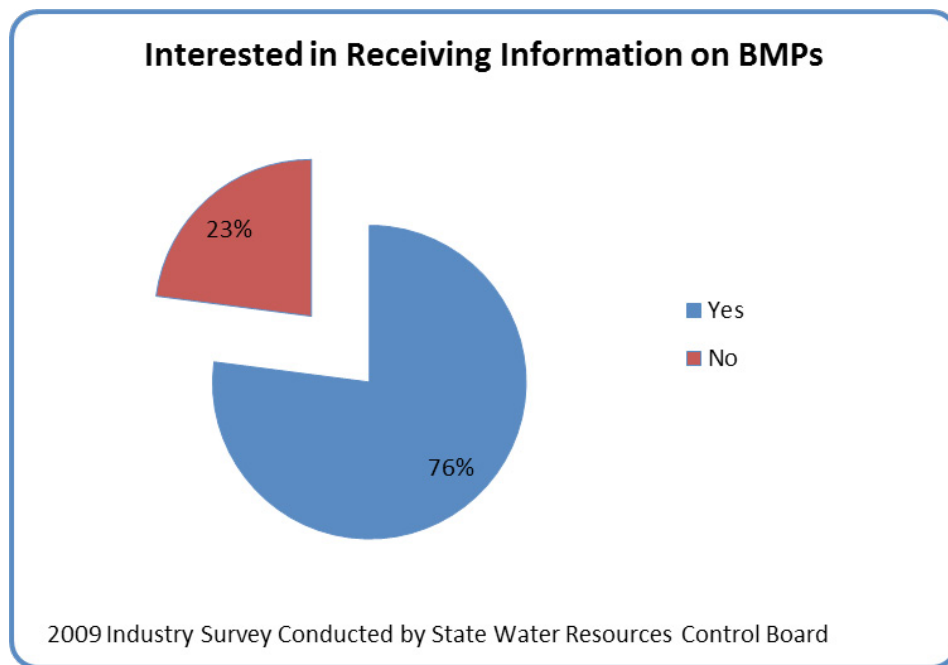

---

**32. Would you be interested in participating in stakeholder work group meetings or teleconferences for the Water Board’s Preproduction Plastics Program?**

Response	Percentage
No	57%
Yes	41%

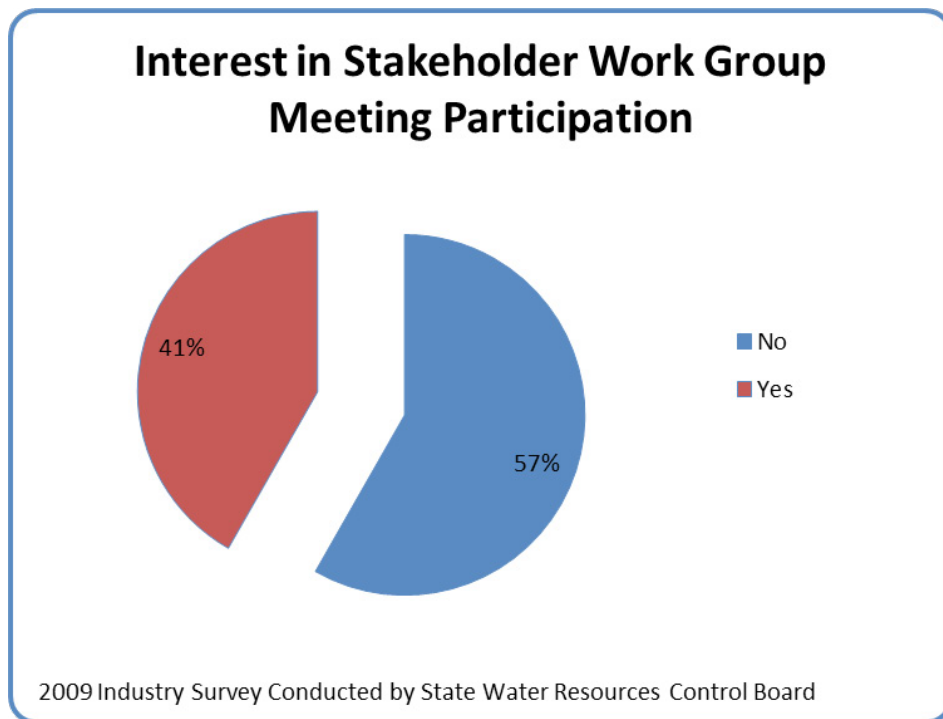

**33. Please provide a short statement explaining your noninvolvement.**

No valid responses were received to this open-ended question. In fact, only three responses in total were received and these were statements to the effect that they did not handle raw materials in pellet form.



---

## APPENDIX J - REFERENCES

---

- 5 Gyres Institute (2013). *Microplastics in consumer products and in the marine environment*. 5 Gyres Institute Position Paper.
- Ackerman, D., & Stein, E.D. (2007). *Hydrodynamic modeling of the San Gabriel River estuary*. Southern California Coastal Water Research Project.
- AECOM Technical Services. (2010). *Economic Impact Analysis: Proposed Ban on Plastic Carryout Bags in Los Angeles County*. Prepared for Sapphos Environmental, Inc. Los Angeles, CA: AECOM Technical Services.
- Ahrens, M.J., Hertz, J., Lamoureux, E.M., Lopez, G.R., McElroy, A.E., & Brownawell, B.J. (2001). The role of digestive surfactants in determining bioavailability of sediment-bound hydrophobic organic contaminants to 2 deposit-feeding polychaetes. *Marine Ecology Progress Series*, 212, 145-157.
- Algalita Marine Research Institute (AMRI). (2013). Algalita Marine Research Blog. Retrieved from <http://www.algalita.org/blog/>.
- Allsopp, M., Walters, A., Santillo, D., & Johnson, P. (2006). Plastic Debris in the World's Ocean. *United Nations Environment Programme*.
- Aloy, A.B., Vallejo, Jr., B.M., & Juinio-Meñez, M.A. (2011). Increased plastic litter cover affects the foraging activity of the sandy intertidal gastropod *Nassarius pullus*. *Marine Pollution Bulletin*, 62, 1772-1779.
- American Chemistry Council (ACC). (2013). *Plastic Resins in the United States*. Washington, D.C.: American Chemistry Council, Plastics Division.
- American Chemistry Council (ACC). (n.d.). The Basics: Polymer Definition and Properties. Retrieved from <http://plastics.americanchemistry.com/The-Basics>.
- American Plastic Manufacturers. n.d. *Plastic Bag Myths*. Retrieved from <http://www.apmbags.com/bagmyths>.
- Andrady, A.L. (1988). Weathering of Polyethylene (LDPE) and Enhanced Photodegradable Polyethylene in the Marine Environment. Research Triangle Institute, P.O. Box 12194, Research Triangle Park, North Carolina 27709.
- Andrady, A.L. (2011). Microplastics in the marine environment. *Marine Pollution Bulletin*, 62, 1596-1605.
- Andrady, A.L., & Neal, M.A. (2009). Applications and societal benefits of plastics. *Philosophical Transactions of the Royal Society*, 364, 1977-1984.
- Artham, T., & Doble, M. (2009). Fouling and Degradation of Polycarbonate in Seawater: Field and Lab Studies. *Journal of Polymers and the Environment*, 17, 170-180.

- 
- Arthur, C., Baker, J., & Bamford, H. (2009). Proceedings of the *International Research Workshop on the Occurrence, Effects and Fate of Microplastic Marine Debris*. Sept 9-11, 2008. NOAA Technical Memorandum NOS-OR&R-30.
- Ashton, K., Holmes, L., & Turner, A. (2010). Association of metals with plastic production pellets in the marine environment. *Marine Pollution Bulletin*, 60, 2050-2055.
- Assembly Bill No. 258. California Legislature, 2013-2014 Regular Session. (2013, June 11). *LegiScan*. Retrieved June 13, 2013, from <http://legiscan.com/CA/bill/AB258/2013>.
- Auman, H.J., Woehler, E.J., Riddle, M.J., & Burton, H. (2004). First evidence of ingestion of plastic debris by seabirds at sub-Atlantic Heard Island. *Marine Ornithology*, 32, 105-106.
- Baird, R.W., & Hooker, S.K. (2000). Ingestion of Plastic and Unusual Prey by a Juvenile Harbour Porpoise. *Marine Pollution Bulletin*, 40(8), 719-720.
- Bakir, A.B., Rowland, S.J., & Thompson, R.C. (2012). Competitive sorption of persistent organic pollutants onto microplastics in the marine environment. *Marine Pollution Bulletin*, 64, 2782-2789.
- Bakir, A., Rowland, S.J., & Thompson, R.C. (2014). Enhanced desorption of persistent organic pollutants from microplastics under simulated physiological conditions. *Environmental Pollution*, 16-23.
- Barnes, D.K. (2002). Invasions by marine life on plastic debris. *Nature*, 416, 808-809.
- Barnes, D.K., (2004). *Natural and plastic flotsam stranding in the Indian Ocean*. In: John Davenport and Julia L. Davenport (eds.) *The Effects of Human Transport on Ecosystems: Cars and Planes, Boats and Trains*, 193-205. Dublin: Royal Irish Academy.
- Barnes, D.K. (2005) Remote islands reveal rapid rise of Southern Hemisphere sea debris. *The Scientific World*, 5, 915-921.
- Barnes, D.K., & Fraser, K.P. (2003). Rafting by five phyla on man-made flotsam in the Southern Ocean. *Marine Ecology Progress Series*, 262, 289-291.
- Barnes, D.K., Galgani, F., Thompson, R.C., & Barbaz, M. (2009). Accumulation and fragmentation of plastic debris in global environments. *Philosophical Transactions of the Royal Society of Biological Sciences*, 364, 1995-1998.
- Barnes, D.K. & Milner, P. (2005). Drifting plastic and its consequences for sessile organism dispersal in the Atlantic Ocean. *Marine Biology*, 146, 815-825.
- Beck, C. (2010). *City Council Motion Regarding the Feasibility of Developing a New Stepped Up Citation Program for Littering (City Council Motion No. 55)*. Report No. Los Angeles, CA: Los Angeles Police Department, Police Chief.
-

- 
- Belton, V.; Crowe, D.; Matthews, R., Scott S. (2994). Survey of public attitudes to recycling in Glasgow. *Waste Management Resources*, 12(4):351–6.
- Blight, L.K., & Burger, A.E. (1997). Occurrence of Plastic Particles in Seabirds from the Eastern North Pacific. *Marine Pollution Bulletin*, 34(5), 323–325.
- Boerger, C.M., Lattin, G.L., Moore, S.L., & Moore, C.J. (2010). Plastic ingestion by planktivorous fishes in the North Pacific Central Gyre. *Marine Pollution Bulletin*, 60(12), 2275-2278.
- Bond, A.L., Provencher, J.F., Elliot, R.D., Ryan, P.C., Rowe, S., Jones, I.L., Robertson, G.J., & Wilhelm, S.I. (2013). Ingestion of plastic marine debris by Common and Thick-billed Murres in the northwestern Atlantic from 1985 to 2012. *Marine Pollution Bulletin*, In Press.
- Bonda, A.L., Jones, I.L., Williams, J.C., & Byrd, G.V. (2011). Auklet (Charadriiformes: Alcidae, *Aethia* spp.) chick meals from the Aleutian Islands, Alaska, have a very low incidence of plastic marine debris. *Marine Pollution Bulletin*, 60, 1346-1349.
- Bourne, W.R., & Imber, M.J. (1982). Plastic Pellets Collected by a Prion on Gough Island, Central South Atlantic Ocean. *Marine Pollution Bulletin*, 13(1), 20-21.
- Browne, M., Crump, P., Niven, S.J., Teuten, E.L., Tonkin, A., Galloway, T., & Thompson, R.C. (2011). Accumulations of microplastic on shorelines worldwide: sources and sinks. *Environmental Science & Technology*.
- Browne, M.A., Dissanayake, A., Galloway, T.S., Lowe, D.M., & Thompson, R.C. (2008). Ingested Microscopic Plastic Translocates to the Circulatory System of the Mussel, *Mytilus Edulis*. *Environmental Science & Technology*, 52, 5026-5031.
- Bugoni, L., Krause, L., & Petry, M.V. (2001). Marine debris and human impacts on sea turtles in Southern Brazil. *Marine Pollution Bulletin*, 42, 1330–1334.
- Buxton, R.T., Currey, C.A., Lyver, P.O., Jones, C.J. (2013). Incidence of plastic fragments among burrow-nesting seabird colonies on offshore islands in northern New Zealand. *Marine Pollution Bulletin*, 74, 420-424.
- California Department of Transportation (CDOT) (2011). *Plastic Debris in the California Marine Ecosystem: A Summary of Current Research, Solution Strategies and Data Gaps*. "San Gabriel River Watershed." Synthetic Report. C. Stevenson, University of Southern California Sea Grant; California Ocean Science Trust. Oakland, CA: California Environmental Protection Agency.
- California Department of Transportation (CDOT). (2013). *Caltrans Workers Hit The Highways To Clean Up California*. Retrieved from <http://www.dot.ca.gov/hq/paffairs/news/pressrel/13pro33.htm>
-

- 
- California Environmental Protection Agency (CEPA). (2009). *The History of the California Environmental Protection Agency*. Retrieved from <http://www.calepa.ca.gov/about/history01/swrcb.htm>.
- California Environmental Protection Agency (CEPA) (2012). *Preproduction Plastic Debris Program*. Retrieved from [http://www.waterboards.ca.gov/water\\_issues/programs/stormwater/plasticdebris.shtml](http://www.waterboards.ca.gov/water_issues/programs/stormwater/plasticdebris.shtml).
- California Ocean Protection Council (COPC). (2008). *An implementation strategy for the California Ocean Protection Council Resolution to Prevent and Reduce Ocean Litter*. Sacramento, CA: California Ocean Protection Council.
- California Regional Water Quality Control Board (CRWQCB<sup>1</sup>). (2007). *Watershed Management Initiative: Chapter 2.4 San Gabriel River Watershed*. Los Angeles, CA: California Regional Water Quality Control Board, Los Angeles Region.
- California Regional Water Quality Control Board, Los Angeles Region (CRWQCB<sup>2</sup>). (2007). *Proposed Amendments to the Water Quality Control Plan – Los Angeles Region for the Legg Lake Trash TMDL*.
- California Regional Water Quality Control Board, Central Valley Region (CVRWQCB). (2013). November 20). *Storm water – MS<sub>4</sub> Permit Program*. Retrieved from [http://www.waterboards.ca.gov/rwqcb5/water\\_issues/storm\\_water/municipal\\_permits/](http://www.waterboards.ca.gov/rwqcb5/water_issues/storm_water/municipal_permits/)
- California Ocean Protection Council (COPC). (2008). *An implementation strategy for the California Ocean Protection Council Resolution to Prevent and Reduce Ocean Litter*. Sacramento, CA: California Ocean Protection Council.
- California Water Board (CWB). (2007). *Trash Total Maximum Daily Load for Legg Lake*. Los Angeles, CA: California Regional Water Quality Control Board, Los Angeles Region.
- California Water Board. (n.d.). *Neighborhood Action Kit [Brochure]*. Sacramento, CA: California Water Boards.
- CalRecycle. (2008). *Plastics Market Information Resources*. Retrieved from <http://calrecycle.ca.gov/plastics/markets/>
- CalRecycle. (2010). *Plastics Information and Resources*. Retrieved from <http://www.calrecycle.ca.gov/plastics/>.
- CalRecycle<sup>1</sup>. (2011). *Plastics Resins*. Retrieved from <http://www.calrecycle.ca.gov/Plastics/Resins/>.
- CalRecycle<sup>2</sup>. (2011). *Plastic Film Cooperative Recycling Initiative*. Retrieved from <http://www.calrecycle.ca.gov/plastics/Film/default.htm>.
- CalRecycle. California Department of Resources Recycling and Recovery. (2013, May). *Calendar Year 2012 Report of Beverage Container Sales, Returns, Redemption, and Recycling Rates*.
-

- 
- Campani, T., Bains, M., Giannetti, M., Cancelli, F., Mancusi, C., Serena, F., Marsili, L., Casini, S., & Fossi, M.C. (2013). Presence of plastic debris in loggerhead turtle stranded along the Tuscany coasts of the Pelagos Sanctuary for Mediterranean Marine Mammals (Italy). *Marine Pollution Bulletin*, 74, 225-230.
- Carr, A. (1987). Impact of Nondegradable Marine Debris on the Ecology and Survival Outlook of Sea Turtles. *Marine Pollution Bulletin*, 18(6B), 352-356.
- Carson, H.S., Nerheima, M.S., Carroll, K.A., & Eriksen, M. (2013). The plastic-associated microorganisms of the North Pacific Gyre. *Marine Pollution Bulletin*, In Press.
- Cascadia Consulting Group (CCG). (2004). *Contractor's Report to the Board*. Retrieved from <http://www.calrecycle.ca.gov/Publications/Documents/LocalAsst/34004005.pdf>.
- City of Los Angeles (City of LA). (2001). *Decade of Progress: Wastewater Program City of Los Angeles*. Los Angeles, CA: City of Los Angeles, Watershed Protection Division, Department of Public Works, Bureau of Sanitation, City of Los Angeles.
- City of Los Angeles (City of LA). (2002). *High Trash-Generation Areas and Control Measures*. Los Angeles, CA: City of Los Angeles, Watershed Protection Division, Department of Public Works, Bureau of Sanitation.
- City of Los Angeles (City of LA<sup>2</sup>). (2006). *Technical Report: Assessment of Catch Basin Inserts*. Los Angeles, CA: City of Los Angeles, Watershed Protection Division, Department of Public Works, Bureau of Sanitation.
- City of Los Angeles (City of LA<sup>2</sup>). (2006). *Technical Report: Assessment of Catch Basin Opening Screen Covers*. Los Angeles, CA: City of Los Angeles, Watershed Protection Division, Department of Public Works, Bureau of Sanitation, City of Los Angeles.
- City of Los Angeles (City of LA). (2011). Los Angeles-Glendale Water Reclamation Plant. Retrieved from [http://www.lasewers.org/treatment\\_plants/la\\_glendale/](http://www.lasewers.org/treatment_plants/la_glendale/).
- City of Los Angeles (City of LA). (n.d.) *Trash TMDL Implementation Strategy and Plan for the Los Angeles River and Ballona Creek Watersheds*. Los Angeles, CA: City of Los Angeles, Watershed Protection Division, Department of Public Works, Bureau of Sanitation.
- Cole, M., Lindeque, P., Halsband, C., & Galloway, T.S. (2011). Microplastics as contaminants in the marine environment: A review. *Marine Pollution Bulletin*, 62, 2588-2597.
- County of Los Angeles (COLA). (2007). *An Overview of Carryout Bags in Los Angeles County*. Los Angeles, CA: County of Los Angeles, Department of Public Works.
- Colabuono, F.I., Barquete, V., Domingues, B.S., & Montone, R.C. (2009). Plastic ingestion by Procellariiformes in Southern Brazil. *Marine Pollution Bulletin*, 58, 93-96.
- Colton Jr., J. B., Burns, B. R., & Knapp, K. D. (1974). Plastic particles in surface waters of the Atlantic Ocean.

- 
- Conner, D.K., & O'Dell, R. (1988). The Tightening Net of Marine Plastics Pollution. *Environment*, 30(1), 16-36.
- Connors, P.G. & Smith, K.G. (1982). Oceanic Plastic Particle Pollution: Suspected Effect on Fat Deposition in Red Phalaropes. *Marine Pollution Bulletin*, 13(1), 18-20.
- Cooper, D.A., & Corcoran, P.L. (2010). Effects of mechanical and chemical processes on the degradation of plastic beach debris on the island of Kauai, Hawaii. *Marine Pollution Bulletin*, 60, 650-654.
- Copeland, C. (2008, July 1). Cruise Ship Pollution: Background, Laws and Regulations, and Key Issues. (Congressional Report No. RL32450). Washington, DC: Library of Congress Congressional Research Service.
- Corcoran, P.L., Biesinger, M.C., & Grifia, M. (2009). Plastics and beaches: A degrading relationship. *Marine Pollution Bulletin*, 58, 80-84.
- Costa, M.F., Ivar do Sul, J.A., & Dantas, D.V. (2011). Plastic debris ingestion by marine catfish: An unexpected fisheries impact. *Marine Pollution Bulletin*, 62, 1098-1102.
- Cunningham, W. & Cunningham, M. (2008). *Principles of environmental science : inquiry & applications (4<sup>th</sup> ed)*. New York, NY: McGraw-Hill Publishing Co.
- Day, R.H., & Shaw, D.G. (1987). Patterns in the Abundance of Pelagic Plastic and Tar in the North Pacific Ocean, 1976-1985. *Marine Pollution Bulletin*, 18( 6B), 311-316.
- Day, R.H., Shaw, D.G., & Ignell, S.E. (1990). The Quantitative Distribution and Characteristics of Neuston Plastic in the North Pacific Ocean: 1985-1988. *Presented at the Proceedings of the Second International Conference on Marine Debris (1989)*. Honolulu, HI. U.S. Department of Commerce. NOAA Technical Memo. NMFS, NOAA-TM-NMFS-SWFSC-154.
- Derraik, J.G. (2002). The pollution of the marine environment by plastic debris: a review. *Marine Pollution Bulletin*, 44, 842-852.
- DeVuono-powell, S. (2013). *Homeless Encampments in Contra Costa County*. Contra Costa County Flood Control and Water Conservation District.
- DiGregorio, B. (2009). Biobased Performance Bioplastic: Mirel. *Chemistry & Biology*, 16, 2-4.
- Downtown Street Teams. (n.d.) Retrieved from <http://streetsteam.org/>.
- Earth Day Network Network. 2009. *Get Rid of Plastic Bags ... and Plastic!* Retrieved from <http://www.earthday.net/plasticbags>.
- Ellis, D. (1998). Plastic Dumping at Sea to be Banned. *Marine Pollution Bulletin*, 19(3), 90-91.
- Elskus, A.A., Collier, T.K., & Monosson, E. (2005). Chapter 4. Interactions between lipids and persistent organic pollutants in fish. In *Biochemistry and Molecular Biology of Fishes, Environmental Toxicology*, T.P. Mommsen & T.W. Moon (Eds.), (Vol. 6, pp. 119-152. St. Louis, MO: Elsevier.
-



- 
- Endo, S., Yuyama, M., & Takada, H. (2013). Desorption kinetics of hydrophobic organic contaminants from marine plastic pellets. *Marine Pollution Bulletin*, 74, 125-131.
- Environmental Literacy Council Council. (2008). *Paper or Plastic?* Retrieved from <http://www.enviroliteracy.org/article.php/1268.html>.
- Environmental Protection Agency (EPA). (1993). *Plastic Pellets in the Aquatic Environment: Sources and Recommendations*. Washington, D.C.: Environmental Protection Agency, Oceans and Coastal Protection Division
- Environmental Protection Agency (EPA). (2009). *National Pollutant Discharge Elimination System (NPDES)*. Retrieved from <http://cfpub.epa.gov/npdes>.
- Environmental Protection Agency (EPA). (2012). *National Marine Debris Monitoring Program*. Retrieved from <http://water.epa.gov/type/oceb/marinedebris/nmdmp.cfm>.
- Environmental Protection Agency (EPA<sup>1</sup>). (2013). *Plastics*. Retrieved from <http://www.epa.gov/osw/conserve/materials/plastics.htm>.
- Environmental Protection Agency (EPA<sup>2</sup>). (2013). *Municipal Solid Waste Generation, Recycling, and Disposal in the United States: Facts and Figures for 2011*. Washington, D.C.: Environmental Protection Agency.
- Eriksen, M., Maximenko, N., Thiel, M., Cummins, A., Lattin, G., Wilson, S., Hafner, J., Zellers, A., & Rifman, S. (2013). Plastic Pollution in the South Pacific subtropical gyre. *Marine Pollution Bulletin*, 68, 71-76.
- Eriksson, C. & Burton, H. (2003). Origins and Biological Accumulation of Small Plastic Particles in Fur Seals from Macquarie Island. *Royal Swedish Academy of Sciences*, 32(6), 380-384.
- European Commission (EC). (2013). *On a European Strategy on Plastic Waste in the Environment*. Brussels, Belgium: European Commission.
- Everett, J.W., & Peirce, J.J. (1993). Curbside Recycling in the U.S.A.: Convenience and Mandatory Participation. *Waste Management & Research*, 11, 49-61.
- Fimrite, P. (2011). Environmentalists hunt wildlife-killing nurdles. *The San Francisco Gate*. Living Section, pp. 1-5.
- Fisner, M., Taniguchi, S., Majer, A.P., Bicego, M., & Turra, A. (2013). Concentration and composition of polycyclic aromatic hydrocarbons(PAHs) in plastic pellets: Implications for small-scale diagnostic and environmental monitoring. *Marine Pollution Bulletin*, In Press.
- Fendall, L.S., & Sewell, M.A. (2009). Contributing to marine pollution by washing your face: Microplastics in facial cleansers. *Marine Pollution Bulletin*, 58, 1225-1228.
- Fotopoulou, K.N., & Karapanagioti, H.K. (2012). Surface properties of beached plastic pellets. *Marine Environmental Research*, 81, 70-77.

- 
- Freinkel, S. (2011). *Plastic- A toxic Love Story*. Houghton Mifflin Harcourt, NY.
- Frias, J.P., Martins, J., & Sobral, P. (2011). Research in plastic marine debris in mainland Portugal. *Journal of Integrated Coastal Zone Management*, 11(1), 145-148.
- Furman A. (2013). *Improving the Science of Trash Management in Urban Watersheds. A Comprehensive Survey of the Fullerton Creek Watershed*. Fullerton, CA: California State University, Fullerton, Environmental Studies Department.
- Furness, B. (1983). Plastic Particles in Three Procellariiform Seabirds from the Benguela Current, South Africa. *Marine Pollution Bulletin*, 14(8), 307-308.
- Global Plastics Association (GPA). (2011). *Declaration of the Global Plastic Associations for Solutions on Marine Litter*. Retrieved from <http://www.marinedebrissolutions.com/Declaration>.
- Global Plastics Association (GPA) (2012). *Declaration of the Global Plastic Associations for Solutions on Marine Litter Progress Report*.
- Gold, M., Mika, K., Horowitz, C., Herzog, M., & Leitner, L. (2013). Stemming the Tide of Plastic Litter: A Global Action Agenda. *Pritzker Environmental Law and Policy Briefs*, Policy Brief No. 5, 1-30.
- Goldberg, E.D. (1997). Plasticizing the Seafloor: An Overview. *Environmental Technology*, 18, 195-202.
- Goldstein, M.C., Rosenberg M., Cheng, L. (2012, May 9). Increased oceanic microplastic debris enhances oviposition in an endemic pelagic insect. *Biology Letters*, 1-4.
- Gordon, M. (2006). *Eliminating Land-based Discharges Of Marine Debris In California: A Plan of Action from The Plastic Debris Project*. California Coastal Commission and Algalita Marine Research Foundation.
- Graham, E.R., & Thompson, J.T. (2009). Deposit- and suspension-feeding sea cucumbers (Echinodermata) ingest plastic fragments. *Journal of Experimental Marine Biology and Ecology*, 368, 22-29.
- Gratz, R.B. (2013, August 06). *Curitiba: An Environmental Showcase*. Huffington Post. Retrieved from [http://www.huffingtonpost.com/roberta-brandes-gratz/curitiba\\_b\\_3713953.html](http://www.huffingtonpost.com/roberta-brandes-gratz/curitiba_b_3713953.html).
- Gregory, M.R. (1983). Virgin plastic granules on some beaches of Eastern Canada and Bermuda. *Marine Environmental Research*, 10, 73-92.
- Gregory, M.R. (2009). Environmental implications of plastic debris in marine settings - entanglement, ingestion, smothering, hangers-on, hitch-hiking and alien invasions. *Philosophical Transactions of the Royal Society, Biological Sciences*, 364, 2013-2025.
- Gumprecht, B. (1999). *The Los Angeles River: Its Life, Death, and Possible Rebirth*. Baltimore: The Johns Hopkins University Press.
-

- 
- Harris, G. (2004). *Proposed Ordinance Amendments – Littering Administrative Enforcement Program Section 56.08, Los Angeles Municipal Code Creating Subsection E, F and G. Report No. 1*. Los Angeles, CA: Department of Public Works, Bureau of Street Services.
- Harshvardhan, K., & Jha, B. (2013). Biodegradation of low-density polyethylene by marine bacteria from pelagic waters, Arabian Sea, India. *Marine Pollution Bulletin*, In Press.
- Harvey, R. (2010). Retrieved from <http://rayharvey.org/index.php/2010/03/mcdonalds-and-the-clam-shell/>
- Harwood, M. (1971). We are killing the sea around us. *New York Times*. p. SM34.
- Hinojosa, I.A., Rivadeneira, M.M., & Thiel, M. (2011). Temporal and spatial distribution of floating objects in coastal waters of central–southern Chile and Patagonian fjords. *Continental Shelf Research*, 31, 172-186.
- Hirai, H., Takada, H., Ogata, Y., Yamashita, R., Mizukawa, K., Saha, M., Kwan, C., Moore, C., Gray, H., Laursen, D., Zettler, E.R., Farrington, J.W., Reddy, C.M., Peacock, E.E., & Ward, M.W. (2011). Organic micropollutants in marine plastics debris from the open ocean and remote and urban beaches. *Marine Pollution Bulletin*, 62, 1683-1692.
- Headworks Inc. (2012). *Case Study: Tillman Water Reclamation Plant - Los Angeles, CA*. Retrieved from <http://www.headworksinternational.com/userfiles/file/Tillman%20Water%20Reclamation%20Plant-Los%20Angeles,%20California.pdf>.
- Integrated Management Waste Board (IMWB). (2004). *Statewide Waste Characterization Study*. Retrieved from <http://www.calrecycle.ca.gov/Publications/Documents/LocalAsst/34004005.pdf>.
- International Maritime Organization (IMO). (n.d.), International Convention for the Prevention of Pollution from Ships (MARPOL). Retrieved from [http://www.imo.org/about/conventions/listofconventions/pages/international-convention-for-the-prevention-of-pollution-from-ships-\(marpol\).aspx](http://www.imo.org/about/conventions/listofconventions/pages/international-convention-for-the-prevention-of-pollution-from-ships-(marpol).aspx).
- Ivar do Sul, J.A., Costa, M.F., Barletta, M., & Cysneiros, F.J. (2013). Pelagic microplastics around an archipelago of the Equatorial Atlantic. *Marine Pollution Bulletin*, 75, 305-309.
- Jacobsen, J.K., Massey, L., & Gulland, F. (2010). Fatal ingestion of floating net debris by two sperm whales (*Physeter macrocephalus*). *Marine Pollution Bulletin*, 60, 765-767.
- Jaeger, R.J., & Rubin R.J. (1970). Plasticizers from Plastic Devices: Extraction, Metabolism, and Accumulation by Biological Systems. *Science*, 170, 460-462.
- Jao, C. (2013). Curbing the Trash Problem of the East Fork San Gabriel River. *KCET. River Notes*.
- Johnson, S. W. (1994). Deposition of Trawl Web on an Alaska Beach after Implementation of MARPOL Annex V Legislation. *Marine Pollution Bulletin*, 28(8), 477-481.
-

- 
- Kalliopi N., Fotopoulou, H., & Karapanagioti, K. (2012). Surface Properties of Beached Plastic Pellets. *Marine Environmental Research*, 81, 70-77.
- Keller, A.A., Fruhb, E.L., Johnson, M.M., Simon, V., & McGourty, C. (2010). Distribution and abundance of anthropogenic marine debris along the shelf and slope of the US West Coast. *Marine Pollution Bulletin*, 60, 692-700.
- KEMA. (2012). *Industrial Sectors Market Characterization: Plastics Industry*. Oakland, CA: KEMA.
- Kershaw, P., Katsuhiko, S., Lee, S., Samseth, J., Woodring, D., & Smith, J. (2011). Plastic debris in the ocean. *United Nations Environmental Programme – UNEP Year Book 2011*.
- Kharaghani, S. (2003, May 31). *Trash TMDL Implementation Cost*. Presentation. SoCal SETAC Annual Meeting.
- Kinver, M. (2012, January 27). Accumulating “Microplastic” Threat to Shores. *BBC News*.
- Kirkley, J., & McConnell, K. (1997). Marine Debris: Benefits, Costs, and Choices. *Springer Series of Environmental Management*, Part II, 171-185.
- Laist, D.W. (1987). Overview of the Biological Effects of Lost and Discarded Plastic Debris in the Marine Environment. *Marine Pollution Bulletin*, 18 (6B), 319-326.
- Lattin, G.L., Moore, C.J., Zellers, A.F., Moore, S.L., & Weisberg, S.B. (2004). A comparison of neustonic plastic and zooplankton at 3 different depths near the southern California shore. *Marine Pollution Bulletin*, 49, 291-294.
- Lavers, J.L., Hodgson, J.C., & Clarke, R.H. (2013). Prevalence and composition of marine debris in Brown Booby (*Sula leucogaster*) nests at Ashmore Reef. *Marine Pollution Bulletin*, In Press.
- Law, K.L., Moret-Ferguson, S., Maximenko, M.A., Proskurowski, G., Peacock, E.E., Hafner, J., & Reddy, C.M. (2010). Plastic Accumulation in the North Atlantic Subtropical Gyre. *Science*, 329, 1185-1188.
- Lebreton, L.C.-M, Greer, S.D., & Borrero, J.C. (2012). *Numerical modeling of floating debris in the world's oceans*. *Marine Pollution Bulletin*, 64, 653-661.
- Lee, J., Hong, S., Song, Y.K., Hong, S.H., Jang, Y.C., Jang, M., Heo, N.W., Han, G.M., Lee, M.J., Kang, D., & Shim, W.J. (2013). Relationships among the abundances of plastic debris in different size classes on beaches in South Korea. *Marine Pollution Bulletin*, In Press, 2013.
- Legg Lake Trash TMDL Jurisdictional Group (LLTTJG). (2008, September 5). *Trash Monitoring & Reporting Plan: Legg Lake Trash TMDL*.
- Lippner, G., Johnston, J., Combs, S., Walter, K., & Marx, D. (2001). *Storm Water Program: Results of the Caltrans Management Pilot Study*. Washington, D.C.: Transportation Research Record 1743, Transportation Research Board, National Research Council, California State University Sacramento, University of California, Davis, California Department of Transportation.
-

- 
- Long, E., Robertson, A., Wolfe, D., Hameedi J., & Sloane, G. (1996). Estimates of the Spatial Extent of Sediment Toxicity in Marine Estuaries. *Environmental Science and Technology*, 30 (12).
- Lopez, R. (2014, February 13). State bill targets plastic beads. Los Angeles Times. Retrieved from <http://articles.latimes.com/2014/feb/13/business/la-fi-california-microbead-ban-20140213>.
- Los Angeles Regional Water Quality Control Board (LARWQCB). (2000). *East Fork San Gabriel River Trash TMDL*. Los Angeles, CA: California Regional Water Quality Control Board, Los Angeles Region.
- Los Angeles Regional Water Quality Control Board (LARWQCB<sup>1</sup>). (2002). [GIS map of the Los Angeles River Watershed]. Data from the Watershed Management Initiative. Retrieved from [http://www.waterboards.ca.gov/rwqcb4/water\\_issues/programs/regional\\_program/wmi/ws\\_losangeles.shtml](http://www.waterboards.ca.gov/rwqcb4/water_issues/programs/regional_program/wmi/ws_losangeles.shtml).
- Los Angeles Regional Water Quality Control Board (LARWQCB<sup>2</sup>). (2002). [GIS map of the San Gabriel River Watershed]. Data from the Watershed Management Initiative. Retrieved from [http://www.waterboards.ca.gov/rwqcb4/water\\_issues/programs/regional\\_program/wmi/ws\\_sangabriel.shtml](http://www.waterboards.ca.gov/rwqcb4/water_issues/programs/regional_program/wmi/ws_sangabriel.shtml).
- Los Angeles Regional Water Quality Control Board (LARWQCB<sup>1</sup>). (2007). *Proposed Amendments to the Water Quality Control Plan – Los Angeles Region for the Legg Lake Trash TMDL*.
- Los Angeles Regional Water Quality Control Board (LARWQCB<sup>2</sup>). (2007). *Trash Total Maximum Daily Loads for the Los Angeles River Watershed (Revised Draft)*. Los Angeles, CA: California Regional Water Quality Control Board, Los Angeles Region.
- Los Angeles Regional Water Quality Control Board (LARWQCB). (2010). *Santa Monica Bay Nearshore and Offshore Debris TMDL (Draft)*. Los Angeles, CA: California Regional Water Quality Control Board, Los Angeles Region.
- Los Angeles Regional Water Quality Control Board (LARWQCB). (2011). *Attachment to Resolution No. R11-XXX (Tentative)*. Los Angeles, CA: California Regional Water Quality Control Board, Los Angeles Region.
- Los Angeles Regional Water Quality Control Board (LARWQCB). (2012). *NPDES Permit No. CAS004001*. California Regional Water Quality Control Board, Los Angeles Region, Order No. R4-2012-0175.
- Los Angeles Regional Water Quality Control Board (LARWQCB). (2013). ORDER NO. R4-2014-xxxx NPDES PERMIT NO. CAS004003. Los Angeles, CA: California Regional Water Quality Control Board, Los Angeles Region.
- Los Angeles Regional Water Quality Control Board (LARWQCB). (n.d.). *Storm Water – Municipal Permits*. Retrieved from [http://www.waterboards.ca.gov/losangeles/water\\_issues/programs/stormwater/municipal/#longbeach](http://www.waterboards.ca.gov/losangeles/water_issues/programs/stormwater/municipal/#longbeach)
-

- 
- Loughlin, Daniel H. and Barlaz, Morton A. 2006. Policies for Strengthening Markets for Recyclables: A Worldwide Perspective. *Critical Reviews in Environmental Science and Technology*, 36: 287-326.
- Lyons, R.D. (1973). The Very Dirty Sea Around Us; Ocean Pollution. *New York Times*. Section WR, p. 4.
- Mato, Y., Isobe, T., Takada, H., Kanehiro, H., Ohtake, C., & Kaminuma, T. (2001). Plastic resin pellets as a transport medium for toxic chemicals in the marine environment. *Environmental Science Technology*. 35, 318–324.
- McDermid, K.J., & McMullen, T.L. (2004). Quantitative analysis of small-plastic debris on beaches in the Hawaiian archipelago. *Marine Pollution Bulletin*, 48, 790-794.
- McDonald, S., & Ball, R. (1998). Public participation in plastics recycling schemes. *Resources, Conservation and Recycling*, 22(3), 123-141.
- Meredith, C. (2013, September 9). Paul Rose, Marine Expert, Says Ocean Litter is Being Ingested by Humans. *Huffington Post UK*. Retrieved from [http://www.huffingtonpost.co.uk/2013/09/09/paul-rose-marine-expert-oceans-plastic\\_n\\_3893520.html?view=screen](http://www.huffingtonpost.co.uk/2013/09/09/paul-rose-marine-expert-oceans-plastic_n_3893520.html?view=screen).
- Moore, C.J. (2008). Synthetic polymers in the marine environment: A rapidly increasing, long-term threat. *Environmental Research*, 108(2), 131-139.
- Moore, C.J., Lattin, G.L., & Zellers, A.F. (2011). Quantity and type of plastic debris flowing from two urban rivers to coastal waters and beaches of Southern California. *Journal of Integrated Coastal Zone Management*, 11(1), 65-73.
- Moore, C.J., Lattin, G.L., & Zellers, A.F. (n.d.). *Measuring the effectiveness of voluntary plastic industry efforts: AMRF's analysis of Operation Clean Sweep*. Algalita Marine Research Foundation.
- Moore, C.J., Moore, S.L., Weisberg, S.B., Lattin, G.L., & Zellers, A.F., (2002). A comparison of neustonic plastic and zooplankton abundance in Southern California coastal waters. *Marine Pollution Bulletin*, 44, 1035-1038.
- Moore, S. (2013). Distribution and Amount of Plastic Pellets and Debris on Beaches in California. Presented at the Southern California Coastal Water Research Project (SCCWRP) [PowerPoint slides presented at Symposium of 2013]. Retrieved from [ftp://ftp.sccwrp.org/pub/download/PRESENTATIONS/Symposium2013/RegMon\\_3\\_Moore.pdf](ftp://ftp.sccwrp.org/pub/download/PRESENTATIONS/Symposium2013/RegMon_3_Moore.pdf).
- Moore, S., & Walther, S. (2005). *The Contribution of Urban Runoff to Marine Debris in Southern California*. Powerpoint Presentation. Plastic Debris Rivers to Sea Conference.
- Moore, S.L., Gregoria, D., Carreon, M., Weisberg, S.B., & Leecaster, M.K. (2001). Composition and Distribution of Beach Debris in Orange County, California. *Marine Pollution Bulletin*, 42, 241-245.
-



- 
- Moret-Ferguson, S., Law, K.L., Proskurowski, G., Murphy, E.K., Peacock, E.E., & Reddy, C.M. (2010). The size, mass and composition of plastic debris in the western North Atlantic Ocean. *Marine Pollution Bulletin*, 60, 1873-1878.
- Morris, R.J. (1980). Plastic Debris in the Surface Waters of the South Atlantic. *Marine Pollution Bulletin*, 11, 164-166.
- Moser, M.L. & Lee, D.S. (1992). A Fourteen-Year Survey of Plastic Ingestion by Western North Atlantic Seabirds. *Colonial Waterbirds*, 15(1), 83-94.
- Murray, F., & Cowie, P.R. (2011). Plastic contamination in the decapod crustacean *Nephrops norvegicus* (Linnaeus, 1758).
- National Oceanic & Atmospheric Administration (NOAA). (1990). *Proceedings on the Second International Conference of Marine Debris*. TM/SWFSC/NOAA-TM-SWFSC-154-P3.pdf.
- National Oceanic and Atmospheric Administration (NOAA). (2008). *Interagency Report on Marine Debris Sources, Impacts, Strategies & Recommendations*. Silver Spring, MD: Interagency Marine Debris Coordinating Committee.
- National Oceanic and Atmospheric Administration (NOAA) (2012). *De-Mystifying the "Great Pacific Garbage Patch"*. Retrieved from <http://marinedebris.noaa.gov/info/patch.html#9>.
- National Oceanic and Atmospheric Administration (NOAA). (2013). *How Big Is the "Great Pacific Garbage Patch"? Science vs. Myth*. Retrieved from <http://response.restoration.noaa.gov/about/media/how-big-great-pacific-garbage-patch-science-vs-myth.html>.
- National Ocean Economics Program (NOEP). (2005). *California's Ocean Economy: A Report Prepared to the Resources Agency, State of California*. Sacramento, CA: California Resources Agency.
- National Resources Defense Fund (NRDC). (n.d.). *Unveiling the Hidden Costs to Californians of Litter Clean-Up*. Retrieved from <http://www.nrdc.org/oceans/files/ca-pollution-in-waterways-IB.pdf>.
- Ng, K.L., & Obbard, J.P. (2006). Prevalence of microplastics in Singapore's coastal marine environment. *Marine Pollution Bulletin*, 52, 761-767.
- Noehammer, H.C., & Byer, P.H. (1997). Effect of design variables on participation in curbside recycling programs, *Waste Management and Research* 15 (1997), pp. 407-427.
- Noyes, J. A. & Kubomoto, R. H. (2004, February 17). *Trash Baseline Monitoring Results Los Angeles and Ballona Creek Watersheds*. Los Angeles, CA: County of Los Angeles, Sanitation Districts of Los Angeles County.
- Ocean Conservancy (OC). (2011). *Tracking Trash: 25 Years of Action for the Ocean. Ocean Conservancy's Coastal Cleanup, 2011 Report*. Washington, D.C.: Ocean Conservancy.
-

- 
- Ogata, Y., Takada, H., Mizukawa, K., Hirai, H., Iwasa, S., Endoa, S., Matoi, Y., Sahaa, M., Okuda, K., Nakashima, A., Murakami, M., Zurcher, N., Booyatumanondo, R., Zakaria, M.P., Dungef, L., Gordon, M., Miguez, C., Suzuki, S., Moore, C., Karapanagioti, H.K., Weerts, S., McClurg, T., Burres, E., Smith, W., Van Velkenburg, M., Lang, J.S., Lang, R.C., Laursenq, D., Danner, B., Stewardson, N., & Thompson, R.C. (2009). International Pellet Watch: Global monitoring of persistent organic pollutants (POPs) in coastal waters. 1. Initial phase data on PCBs, DDTs, and HCHs. *Marine Pollution Bulletin*, 58, 1437-1446.
- Pegram, J.E., & Andrady, A.L. (1989). Outdoor Weathering of Selected Polymeric Materials under Marine Exposure Conditions. *Polymer Degradation and Stability*, 26, 333-345.
- Pelegrin Research. (2004). *Storm Water Public Education Program Resident Population Telephone Survey – 2004 Evaluation and Next Steps*. Los Angeles, CA: State Water Resources Control Board.
- Piasecki, J. (2013, July 15). Diverting recycled water could save Burbank thousands of dollars. *The Burbank Leader*.
- Petry, M.V., Kruger, L., Simone da Silva Fonseca, V., Brummelhaus, J., & da Cruz Piuco, R. (2009). Diet and ingestion of synthetics by Cory's Shearwater *Calonectris diomedea* off southern Brazil. *Journal of Ornithology*, 160, 601-606.
- Plastics Europe. (2010). *Plastics – the Facts 2010: An analysis of European plastics production, demand and recovery for 2009*. Brussels, Belgium: Plastics Europe.
- Plastics Europe. (2012). *Plastics – the Facts 2012. An analysis of European plastics production, demand and recovery for 2011*. Brussels, Belgium: Plastics Europe.
- Plastics Europe. (2013). *Plastics – the Facts 2013: An analysis of European latest plastics production, demand and waste data*. Brussels, Belgium: Plastics Europe.
- Plastics Europe. (n.d.) *Types of plastics*. Retrieved from <http://www.plasticseurope.org/what-is-plastic/types-of-plastics-11148.aspx>.
- Porta, M. & Zumeta, E. (2002). Implementing the Stockholm treaty on persistent organic pollutants. *Occup Environ Med*, 59, 651-3.
- Product Policy Institute. (n.d.). About EPR. Retrieved from [www.productpolicy.org](http://www.productpolicy.org)
- Product Policy Institute. (n.d.). Framework in North America. Leading the way to a waste-free economy. Retrieved from <http://www.productpolicy.org/content/framework-north-america>.
- Provencher, J.F., Gaston, A.J., Mallory, M.L., O'hara, P.D., & Gilchrist, H.G. (2010). Ingested plastic in a diving seabird, the thick-billed murre (*Uria lomvia*), in the eastern Canadian Arctic. *Marine Pollution Bulletin*, 60, 1406-1411.
- Pruter, A.T. (1987). Sources, Quantities, and Distribution of Persistent Plastics in the Marine Environment. *Marine Pollution Bulletin*, 18(6B), 305-310.
-

- 
- Ribic, C.A., Sheavly, S.B., Rugg, D.J., & Erdmann, E.S. (2012). Trends in marine debris along the U.S. Pacific Coast and Hawai'i 1998–2007. *Marine Pollution Bulletin*, 64, 994-1004.
- Richards, Z.T., & Beger, M. (2011). A quantification of the standing stock of macro-debris in Majuro lagoon and its effect on hard coral communities. *Marine Pollution Bulletin*, 62, 1693-1701.
- Rios, L.M., Moore, C., & Jones, P.R. (2007). Persistent organic pollutants carried by synthetic polymers in the ocean environment. *Marine Pollution Bulletin*, 54: 1230-1237.
- Robards, M.D., Piatt, J.F., & Wohl, K.D. (1995). Increasing frequency of plastic particles ingested by seabirds in the subarctic North Pacific Original Research Article. *Marine Pollution Bulletin*, 30(2), 151-157.
- Rochman, C., Browne, M.A., Halpern, B.S., Hentschel, B.T., Hoh, E., Karapanagioti, H.K., Rios-Mendoza, L.M., Takada, H., Teh, S., & Thompson, R.C. (2013). Classify plastic waste as hazardous. *Nature*, Comment, 494, 169-171.
- Rodriguez, B., Bécares, J., Rodriguez, A., & Arocs, J.M. (2013). Incidence of entanglements with marine debris by northern gannets (*Morus bassanus*) in the non-breeding grounds. *Marine Pollution Bulletin*, 75, 259-263.
- Romanow, Kerrie. (2012). *Bring Your Own Bag Ordinance Implementation Results and Actions to Reduce EPS Foam Food Ware*. San Jose, CA: City of San Jose, Transportation and Environment Committee Memorandum.
- Roy, P.K., Hakkarainen, M., Varma, I.K., & Albertsson, A.C. (2011). Degradable Polyethylene: Fantasy or Reality. *Environmental Science & Technology*, 45, 4217-4227.
- Ruus, A., Schaanning, M., Øxnevad, S., & Hylland, K. (2005). Experimental results on bioaccumulation of metals and organic contaminants from marine sediments. *Aquatic Toxicology*, 72, 273-292.
- Ryan, P.G. (1988). Effects of Ingested Plastic on Seabird Feeding: Evidence from Chickens. *Marine Pollution Bulletin*, 19(3), 125-128.
- Ryan, P.G. (2008). Seabirds indicate changes in the composition of plastic litter in the Atlantic and south-western Indian Oceans. *Marine Pollution Bulletin*, 56, 1406-1409.
- Ryan, P.G. (2013). A simple technique for counting marine debris at sea reveals steep litter gradients between the Straits of Malacca and the Bay of Bengal. *Marine Pollution Bulletin*, 69, 128-136.
- Ryan, P.G & Jackson, S. (1987). The Lifespan of Ingested Plastic Particles in Seabirds and their Effect on Digestive Efficiency. *Marine Pollution Bulletin*, 18(5), 217-219.
- Sahugun, L. (2012). An Alpine Creek that Reeks.

- 
- Saido, K., Itagaki, T., Sato, H., Kodera, Y., Abe, O., Ogawa, N., Chung, S.Y., & Miyashita, K. (2009). Proceedings from 238th ACS National Meeting, August 22-26, 2009: *New contamination derived from marine debris plastics*. Washington, DC: Environmental Division.
- Sanitation Districts of Los Angeles County (LACSD). (2013, February 9). *Annual Biosolids Monitoring Report*.
- Sanitation Districts of Los Angeles County (LACSD). (n.d.). Wastewater Facilities. Retrieved from <http://www.lacsd.org/default.asp>.
- Santos, R., Friedrich, A.C., & Barretto, F.P. (2005). Overseas garbage pollution on beaches of northeast Brazil. *Marine Pollution Bulletin*, 50, 778-786.
- Sazima, I., Gadig, O.B., Namora, R.C., & Motta, F.S. (2002). Plastic debris collars on juvenile carcharhinid sharks (*Rhizoprionodon lalandii*) in southwest Atlantic. *Marine Pollution Bulletin*, 44, 1147-1149.
- Schultz, P.W., & Stein, S.R. (2009) Litter in America: National Findings and Recommendations.
- Schwarz, T. and Wells, S. (1999) Storm Water Particle Removal using Cross-Flow Filtration and Sedimentation. *Advances in Filtration and Separation Technology, Volume 12*. 219-226.
- Schwartz, J. (2014, February 10). Ban Sought on Microbeads in Beauty Items. *The New York Times*. Retrieved from [http://www.nytimes.com/2014/02/11/nyregion/ban-sought-on-microbeads-in-beauty-items.html?\\_r=0](http://www.nytimes.com/2014/02/11/nyregion/ban-sought-on-microbeads-in-beauty-items.html?_r=0).
- Schulyer, Q., Hardesty, B.D., Wilcox, C., & Townsend, C. (2013). Global Analysis of Anthropogenic Debris Ingestion by Sea Turtles. *Conservation Biology*, 00(01), 1-11.
- Seidner, D. (2010). Preproduction Plastic Debris Program Compliance Evaluation Survey: Final Report. *CA State Water Board Division of Water Quality, Storm Water Program Industrial and Construction Discharges Unit (ICDU)*.
- Shapiro, M. (2011, June 17). National Public Radio interview.
- Shaw, D.G. (1977). Pelagic tar and plastic in the Gulf of Alaska and Bering Sea. *Science of the Total Environment*, 8, 13-20.
- Shaw, D.G., & Day, R.H. (1994). Colour- and form-dependent loss of plastic micro-debris from the North Pacific Ocean. *Marine Pollution Bulletin*, 28(1), 39-43.
- Shaw, D.G., & Mapes, G.A. (1979). Surface circulation and the distribution of pelagic tar and plastic. *Marine Pollution Bulletin*, 10, 160-162.
- Sheavly, S.B. (2007). *National Marine Debris Monitoring Program: Final Program Report, Data Analysis and Summary*. Prepared for U.S. Environmental Protection Agency by Ocean Conservancy, Grant No. X83053401-02.

- 
- Shimoda Group, LLC. (2010). *Los Angeles River Watershed Trash Reduction Overview*. Prepared for the Greenway Foundation.
- Sivan, A. (2011). New perspectives in plastic biodegradation. *Current Opinion in Biotechnology*, 22, 422-426.
- Sierra Club, Rio Grande Chapter. (n.d.) Groups Unite to Restore Santa Fe River and Help the Homeless. Retrieved February 2nd, 2014 from <http://nmsierraclub.org/groups-unite-to-restore-santa-fe-river-and-help-the-homeless>.
- Smith, D. (2008). Sony Electronics Inc. National Takeback and Recycling Program. As easy to recycle as it is to purchase.
- Society of the Plastics Industry (SPI). (2012). *Degradable Plastics*. Retrieved from <http://www.plasticsindustry.org/AboutPlastics/content.cfm?ItemNumber=657> HYPERLINK "http://www.plasticsindustry.org/AboutPlastics/content.cfm?ItemNumber=657&navItemNumber=1127"&HYPERLINK "http://www.plasticsindustry.org/AboutPlastics/content.cfm?ItemNumber=657&navItemNumber=1127" navItemNumber=1127.
- Stamper, M.A., Whitaker, B.R., & Schofield, T.D. (2006). Case Study: Morbidity in a Pygmy Sperm Whale (*Kogia breviceps*) due to Ocean-Borne Plastic. *Marine Mammal Science*, 22(3), 719-722.
- Starkey, R. Business and Sustainable Development (1996). Eathscan Publications Ltd.
- State Water Resources Control Board. (SWRCB). (2010, September). *Public Scoping Meeting for Proposed Statewide Policy for Trash Control in Waters of the State*. Sacramento, CA: California Environmental Protection Agency, State Water Resources Control Board.
- State Water Resources Control Board (SWRCB). (2011). *Total Maximum Daily Loads*. Los Angeles, CA: California Regional Water Quality Control Board, Los Angeles Region.
- State Water Resources Control Board (SWRCB). (2012). *National Pollutant Discharge Elimination System (NPDES) General Permit Fact Sheet for Storm Water Discharges Associated with Industrial Activities NPDES NO. CAS000001 [DRAFT]*. Sacramento, CA: California Environmental Protection Agency, State Water Resources Control Board.
- State Water Resources Control Board (SWRCB). (2013). *National Pollutant Discharge Elimination System (NPDES) Statewide Storm Water Permit Waste Discharge Requirements (WDRS) for State of California, Department of Transportation*. Sacramento, CA: California Environmental Protection Agency, State Water Resources Control Board.
- State Water Resources Control Board (SWRCB). (2013, August 9). *Fact Sheet - Control of Trash Entering Waterways in California*. Sacramento, CA: California Environmental Protection Agency, State Water Resources Control Board.
- State Water Resources Control Board (SWRCB). (2013, July 10). *Statewide Water Quality Control Plans for Trash – Public Advisory Group*. Retrieved from [http://www.waterboards.ca.gov/water\\_issues/programs/trash\\_control/pag/](http://www.waterboards.ca.gov/water_issues/programs/trash_control/pag/).
-

- 
- State Water Resources Control Board (SWRCB). (n.d.). *State Water Resources Control Board (State Water Boards) Water Quality Order No. 97-03-DWQ. National Pollutant Discharge Elimination System (NPDES) General Permit No. CAS0000001*. Sacramento, CA: California Environmental Protection Agency, State Water Resources Control Board.
- Stein, E., Dark, S., Longcore, T., Hall, N., Beland, M., Grossinger, R., Casanova, J., & Sutula, M. (2007). Historical Ecology and Landscape Change of the San Gabriel River and Floodplain. *State Water Resources Control Board Technical Report #499. Southern California Coastal Water Research Project*.
- Stevenson, C. (2011). *Plastic Debris in the California Marine Ecosystem: A Summary of Current Research, Solution Strategies and Data Gaps. Synthetic Report*. Oakland, CA: California Ocean Science Trust, University of Southern California Sea Grant.
- Stickel, B.H., Jahn, A., & Kier, B. (2013). *Waste in our Water: The Annual Cost to California Communities of Reducing Litter that Pollutes our Waterways*. San Francisco, CA: National Resources Defense Council.
- Stoll, C. (2013). Reusable Container Program Expands. Retrieved from <http://www.green.harvard.edu/news/reusable-container-program-expands>.
- Syrek, D.G., Kayhanian, M., & Meyer, S. (2003). *A Regression Model to Predict Litter in Urban Freeway Outfalls After Rainstorms*. Sacramento, CA: Stormwater Program, California State University, Sacramento.
- Teuten, E.L., Rowland S.J., Galloway T.S., & Thompson R.C. (2007). Potential for Plastics to Transport Hydrophobic Contaminants. *Environmental Science Technology*, 41, 7759-7764.
- Teuten, E.L, Saquing J.M., Detlef R. U., et all. (2009). Transport and Release of Chemicals from Plastics to the Environment and to Wildlife. *Philosophical Transactions of the Royal Society*, 364, 2027-2045.
- Thompson, R.C., Olsen, Y., Mitchell, R.P., Davis, A., Rowland, S.J., John, A.W., McGonible, D., & Russell, A.E. (2004) Lost at Sea: Where is All the Plastic? *Science*, 304, 838.
- Thompson, R.C., Swan, S.H., Moore, C.J., & von Saal, F.S. (2009) Our plastic age. *Philosophical Transactions of the Royal Society*, 364, 1973-1976.
- Todd, P.A., Ong, X., & Chou, L.M. (2010). Impacts of pollution on marine life in Southeast Asia. *International Journal of Biodiversity and Conservation*, 19, 1063-1082.
- Tomás, J., Guitart, R., Mateo, R., & Raga, J.A., 2002. Marine debris ingestion in loggerhead sea turtles, *Caretta caretta*, from the Western Mediterranean. *Marine Pollution Bulletin* 44, 211–216.
- Tourhino, P.S., Ivar do Sul, J.A., & Fillmann, G. (2010). Is marine debris ingestion still a problem for the coastal marine biota of southern Brazil? *Marine Pollution Bulletin*, 60, 396-401
-



- 
- Tyack, N. (2011). *A Trash Biography: Friends of the Los Angeles River Trash Report*. Los Angeles, CA: Friends of the Los Angeles River.
- United Nations Environmental Programme (UNEP). (2005). *Marine Litter: An analytical overview*. Belgium, Brussels: United Nations Environmental Programme.
- United Nations Environmental Programme (UNEP). (2006). *Plastic Debris in the World's Oceans*. Belgium, Brussels: United Nations Environmental Programme.
- United Nations Environmental Programme (UNEP). (n.d.). *Project Converting Waste Plastic Into Fuel*. Retrieved from <http://www.unep.org/ietc/ourwork/wastemanagement/projects/wasteplasticsproject/tabid/79203/default.aspx>.
- Van Franeker, J.A. (1985). Plastic Ingestion in the North Atlantic Fulmar. *Marine Pollution Bulletin*, 16(9), 367-369.
- Van Franeker, J. A., & Bell, P.J. (1988). Plastic Ingestion by Petrels Breeding in Antarctica. *Marine Pollution Bulletin*, 19(12), 672-674.
- Wagner, M., & Oehlmann, J. (2009). Endocrine disruptors in bottled mineral water: total estrogenic burden and migration from plastic bottles. *Environmental Science and Pollution Research*, 16, 278-286.
- Waluda, C., & Staniland, I.J. (2013). Entanglement of Antarctic fur seals at Bird Island, South Georgia. *Marine Pollution Bulletin*, 74, 244-252.
- Wargo, J., Cullen, M., & Taylor, H. (2008). Plastics that maybe harmful to children and reproductive health. Environmental and Human Health Inc.
- Wassener, B. (2012, October 15). A Plan to Go Halfway Around the World, Fueled by Plastic Trash. *The New York Times*. Retrieved from [http://www.nytimes.com/2012/10/16/business/energy-environment/halfway-around-the-world-fueled-by-plastic-trash.html?\\_r=0](http://www.nytimes.com/2012/10/16/business/energy-environment/halfway-around-the-world-fueled-by-plastic-trash.html?_r=0).
- Wastler, T.A. (1981). Ocean dumping permit program under the London dumping convention in the United States. *Chemosphere*, 10(6), 659-668.
- Webb, H.K., Crawford, R.J., Sawabe, T., & Ivanova, E.P. (2009). Poly(ethelene terephthalate) Polymer Surfaces as Substrate for Bacterial Attachment and Biofilm Formation. *Microbes and Environments*, 24(1), 39-42.
- West Coast Governors' Alliance on Ocean Health (WCGA). (2013). *Marine Debris Strategy for the West Coast Governors' Alliance on Ocean Health*.
- Weston Solutions, Inc. (WSI). (2011). *Marine Debris in the North Pacific. A summary of existing information and data gaps*. San Francisco, CA: Environmental Protection Agency, Region 9.

- 
- Whitford, David. The Snack Food That's Packing America. Retrieved from <http://www.inc.com/magazine/19961001/1828.html>.
- Wilson, A. (2013). Sunnyvale's homeless find hope in Downtown Streets Team. *San Jose Mercury News*. Top Stories.
- Wolfe, D.A. (1987). Persistent Plastics and Debris in the Ocean: an International Problem of Ocean Disposal. *Marine Pollution Bulletin*, 18(6B), 303-305.
- Wong, C.S., Green, D.R., & Cretney, W.J. (1976). Distribution and source of tar on the Pacific Ocean. *Marine Pollution Bulletin*, 7, 102-106.
- WorldWatch Institute. 2008. *Plastic Bags – A Necessary Eyesore?* Retrieved from <http://www.worldwatch.org/node/1499>.
- Yaroslavsky, Z. (2011, March 31). Boom Times on the L.A. River. *Los Angeles County*. Retrieved from <http://zev.lacounty.gov/news/environment/boom-times-on-the-l-a-river>.
- Yarsley, V.E. & Couzens, E.G. (1945). *Plastics*. New York, NY: Pelican Books.
- Zavis, A. (2010, December 14). Homeless encampment along LA River broken up. *Los Angeles Times*. Retrieved from <http://articles.latimes.com/2010/dec/14/local/la-me-homeless-20101214>.
- Zettler, E.R., Mincer, T.J., & Amaral-Zettler, L.A. (2013). Life in the "Plastisphere": Microbial Communities on Plastic Marine Debris. *Environmental Science & Technology*, 47, 7137-7146.
- Zheng, Y., & Bassi, A.S. (2005). A Review of Plastic Waste Biodegradation. *Critical Reviews in Biotechnology*, 25, 243-250
- Zitko V. (1993). Expanded polystyrene as a source of contaminants. *Marine Pollution Bulletin*, 26, 584-585.
- Zubris, K., Richards, B. (2005). Synthetic fibers as an indicator of land application of sludge. *Environmental Pollution*.

---

**Reducing Plastic Debris in the Los Angeles  
and San Gabriel River Watersheds**

Bren School of Environmental Science &  
Management

email: [laplastics@lists.bren.ucsb.edu](mailto:laplastics@lists.bren.ucsb.edu)

web: [bren.ucsb.edu/~laplastics](http://bren.ucsb.edu/~laplastics)