



CITY OF LONG BEACH

H-2

DEPARTMENT OF DEVELOPMENT SERVICES

333 W. Ocean Boulevard Long Beach, California 90802 562-570-6194 FAX 562-570-6068

February 16, 2010

HONORABLE MAYOR AND CITY COUNCIL
City of Long Beach
California

RECOMMENDATION:

Receive supporting documentation into the record, conclude the public hearing, and Declare the Ordinance amending the Land Use District Map of the City of Long Beach from CCA (Automobile-Oriented Commercial) to CCN (Community R-4-N) at 3232 and 3290 E. Artesia Boulevard, read the first time and laid over to the next regular meeting of the City Council for final reading; and

Adopt a Resolution amending the Land Use Element of the General Plan from LUD No. 8N to LUD No. 4 at 3232 and 3290 E. Artesia Boulevard, for the purpose of allowing the development of a three-story, 61-unit senior apartment building at 3290 E. Artesia Boulevard. (District 9)

DISCUSSION

The applicant, Palm Desert Development Company, is proposing to construct a three-story, 61-unit affordable senior apartment building at 3290 E. Artesia Boulevard. The facility will consist of 49 one-bedroom units, 11 two-bedroom units, and one three-bedroom manager's unit. Building amenities include a large central courtyard, a pool, spa, fire pit, picnic area, exercise room, community rooms, classroom and recreation rooms. A second parcel located at 3232 E. Artesia Boulevard is also included in the project. That parcel, which contains the Windsor Gardens Convalescent Center, will only undergo a General Plan Amendment and Zone Change (Exhibit A – Plans and Photographs).

In order to construct the project, an amendment to the General Plan from Land Use District 8N to 4 and change in Zone from CCA to CCN are necessary. The amendments to the General Plan and Zone will allow for the placement of residential units and an increase in height and density at the project site. The proposed project will be located on a major corridor, situated near public transportation and shopping, and will provide much needed senior housing to an area that is lacking senior facilities and services.

On February 4, 2010, the Planning Commission reviewed the Site Plan Review and Conditional Use Permit, and made a recommendation that the City Council approve the proposed amendment to the General Plan and change of Zone (Exhibit B – Findings and Conditions of Approval).

Along with entitlements requested above, a Mitigated Negative Declaration was required to determine if there would be any significant effects to the environment. The Mitigated Negative Declaration was circulated for review from December 31, 2009 to February 1, 2010 and was certified by Planning Commission on February 4, 2010 (Exhibit C – Mitigated Negative Declaration). With incorporated Mitigation Measures, there were no significant impacts to the environment associated with the proposed project and no comments have been received at this time.

This letter was reviewed by Assistant City Attorney Michael Mais on February 1, 2010 and by Budget and Performance Management Bureau Manager David Wodynski on February 1, 2010.

TIMING CONSIDERATIONS

The Long Beach Municipal Code requires a hearing within 60 days following positive Planning Commission action. City Council action is requested on February 16, 2010 to assist the applicant in meeting a March 1, 2010 deadline for anticipated funding from the Long Beach Housing Development Company.

FISCAL IMPACT

There is no fiscal impact associated with the requested General Plan amendment and Zone Change.

SUGGESTED ACTION:

Approve recommendation.

Respectfully submitted,

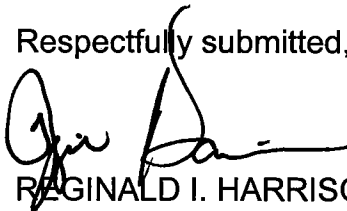

REGINALD I. HARRISON
INTERIM DIRECTOR OF DEVELOPMENT SERVICES

RH:DB:sv

P:\Planning\City Council Items (Pending)\Council Letters\2010-2-16\CCLTR 02.16.10v4.doc

- Attachments: Exhibit A – Plans and Photographs
Exhibit B – Findings and Conditions of Approval
Exhibit C – Mitigated Negative Declaration
City Council Zoning Ordinance
City Council Resolution

APPROVED:

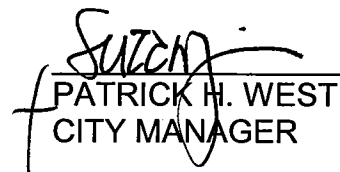

PATRICK H. WEST
CITY MANAGER



ARTESIA BLVD. SENIOR HOUSING

TOTAL UNITS :	61 UNITS
LOT SIZE:	1.7 (+/-) ACRE
GROSS DENSITY:	35.9 DU/AC
LOT COVERAGE:	60% (+/-)
TOTAL BUILDING AREA:	70,673 S.F.
F.A.R.:	1.0
COURTYARD:	7,787 S.F.

PARKING

PARKING REQ.:	
1/UNIT FOR RES.	61
1/4UNITS FOR GUEST:	15
TOTAL:	76
PARKING PROV.:	
GARAGE:	66
SURFACE STD:	16
SURFACE PARELLEL:	7
TOTAL:	89

BUILDING AREA:

	GARAGE LEVEL	PODIUM LEVEL	3RD LEVEL	TOTAL
GARAGE	27,627			27,627
COM. SPACES	6,823			6,823
LOBBY/LEASING	1,288			1,288
REC. AREA/ LAU./ CLUB		2,210	2,218	4,428
COORIDOR/ STAIR/TRASH		5,339	5,331	10,670
RESIDENTIAL	715	21,076	21,076	42,867
TOTAL	36,453	28,625	28,625	93,703

2-LEVEL RES. ABOVE 1-LEVEL PODIUM							JOB # 2008418	
UNIT	UNIT TYPE	NET S.F.	BAL. S.F.	GR. S.F.	NO.	%	TL. NET	TL. GR. S.F.
A1	1BR/1BA	589	61	650	44	73%	25,916	28,600
A2	1BR/1BA	610	78	688	4	7%	2,440	2,752
B1	2BR/2BA	760	44	804	8	13%	6,080	6,432
B2	2BR/2BA	972	120	1,092	4	7%	3,888	4,368
TOTAL					60	100%	38,324	42,152
AVERAGE UNIT SIZE:		703 S.F.						
MANAGER'S UNIT:		715 S.F.						

LEGAL DESCRIPTION:
 THE WEST HALF OF LOT 32, BLOCK 28 OF CALIFORNIA COOPERATIVE COLONY TRACT, IN THE CITY OF LONG BEACH, COUNTY OF LOS ANGELES, STATE OF CALIFORNIA, AS PER MAP RECORDED IN BOOK 21 PAGES 15 AND 16 OF MISCELLANEOUS RECORDS, IN THE OFFICE OF THE COUNTY RECORDER OF SAID COUNTY.

EXCEPT THAT PORTION OF SAID LOT DESCRIBED IN THE DEED TO THE STATE OF CALIFORNIA RECORDED ON JULY 12, 1951 AS INSTRUMENT NO. 3205 IN BOOK 36746 PAGE 348, OFFICIAL RECORDS.

ALSO EXCEPTING THE WESTERLY 370.20 FEET OF LOT 32, BLOCK 28 OF CALIFORNIA COOPERATIVE COLONY TRACT, AS PER MAP RECORDED IN BOOK 21 PAGES 15 AND 16 OF MISCELLANEOUS RECORDS, IN THE OFFICE OF THE COUNTY RECORDER OF SAID COUNTY.
 APN: 7120-003-034

Site Address:
 3290 East Artesia Boulevard, Long Beach, CA

Existing land Use: Commercial Structure, Farmers and Merchants Bank of Long Beach

Proposed Use: Multifamily, Senior Housing

ZONING:
 EXISTING: CCA (AUTOMOBILE ORIENTED COMMERCIAL)
 REZONE TO R-4-N (HIGH DENSITY RESIDENTIAL)
 GENERAL PLAN:
 EXISTING: LUD#8 (SHOPPING NODES)
 GENERAL PLAN AMENDMENT TO LUD#4 (HIGH DENSITY RESIDENTIAL)

NOTE:
 ALL PROPERTY LINES, SETBACKS AND SITE IMPROVEMENTS ARE TO THE BEST OF OUR ACKNOWLEDGE, AND SHALL BE VERIFIED BY CIVIL.

SITE PLAN
 SCALE: 1/16" = 1'-0"

ARTESIA BLVD. SENIOR HOUSING
PALM DESERT DEVELOPMENT CO.

JUNE 1, 2009 LONG BEACH, CA HPA#08418



HUMPHREYS & PARTNERS ARCHITECTS L.P.
 5339 Alpha Road, Suite 300 Dallas, TX 75240 (972) 701-9636 (972) 701-9639
 www.humphreys.com marketing@humphreys.com
 DALLAS CHARLOTTE IRVINE LAS VEGAS NEW ORLEANS NORFOLK ORLANDO PHOENIX

© 2008 by HUMPHREYS & PARTNERS ARCHITECTS, LP
 The arrangements depicted herein are the sole property of Humphreys & Partners Architects, LP and may not be reproduced in any form without its written permission.
 Archtural conceptual site plans are for feasibility purpose only. Revisions may occur due to further investigation from regulatory authorities and build ng code analysis. Dimensions shown are of a strategic intent only. Refer to surveys and civil drawings for technical information and measurements.



NORTH ELEVATION
 (ALONG EAST ARTESIA BLVD.)
 SCALE: 1/8" = 1'-0"



EAST ELEVATION
 (ALONG INDIANA AVE.)
 SCALE: 1/8" = 1'-0"

0' 10' 20' ELEVATIONS

ARTESIA BLVD. SENIOR HOUSING
 PALM DESERT DEVELOPMENT CO.

AUGUST 10, 2009 LONG BEACH, CA HPA#08418



HUMPHREYS & PARTNERS ARCHITECTS L.P.

5339 Alpha Road, Suite 300 Dallas, TX 75240 (972) 701-9636 (972) 701-9639
 www.humphreys.com marketing@humphreys.com
 DALLAS CHARLOTTE IRVINE LAS VEGAS NEW ORLEANS NORFOLK ORLANDO PHOENIX

© 2008 by HUMPHREYS & PARTNERS ARCHITECTS, LP
 The arrangements depicted herein
 are the sole property of Humphreys
 & Partners Architects, LP and may
 not be reproduced in any form
 without its written permission

Architectural conceptual site plans are for feasibility purpose
 only. Revisions may occur due to further investigation from
 regulatory authorities and building code analysis. Dimensions
 shown are of a strategic intent only. Refer to surveys and civil
 drawings for technical information and measurements.



WEST ELEVATION
SCALE: 1/8" = 1'-0"

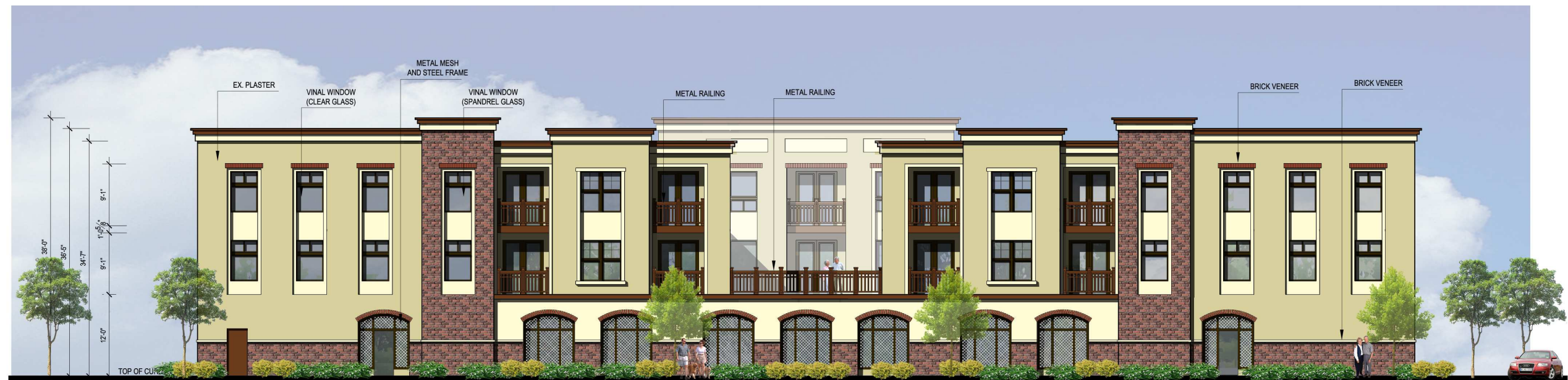

SOUTH ELEVATION
(FACING RAMONA PARK)
SCALE: 1/8" = 1'-0"

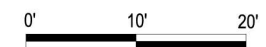

ELEVATIONS

ARTESIA BLVD. SENIOR HOUSING PALM DESERT DEVELOPMENT CO.

AUGUST 10, 2009

LONG BEACH, CA

HPA#08418



HUMPHREYS & PARTNERS ARCHITECTS L.P.

5339 Alpha Road, Suite 300 Dallas, TX 75240 (972) 701-9636 (972) 701-9639

www.humphreys.com marketing@humphreys.com

DALLAS CHARLOTTE IRVINE LAS VEGAS NEW ORLEANS NORFOLK ORLANDO PHOENIX

© 2008 by HUMPHREYS & PARTNERS ARCHITECTS, LP
The arrangements depicted herein are the sole property of Humphreys & Partners Architects, LP and may not be reproduced in any form without its written permission.

Architectural conceptual site plans are for feasibility purpose only. Revisions may occur due to further investigation from regulatory authorities and building code analysis. Dimensions shown are of a strategic intent only. Refer to surveys and civil drawings for technical information and measurements.

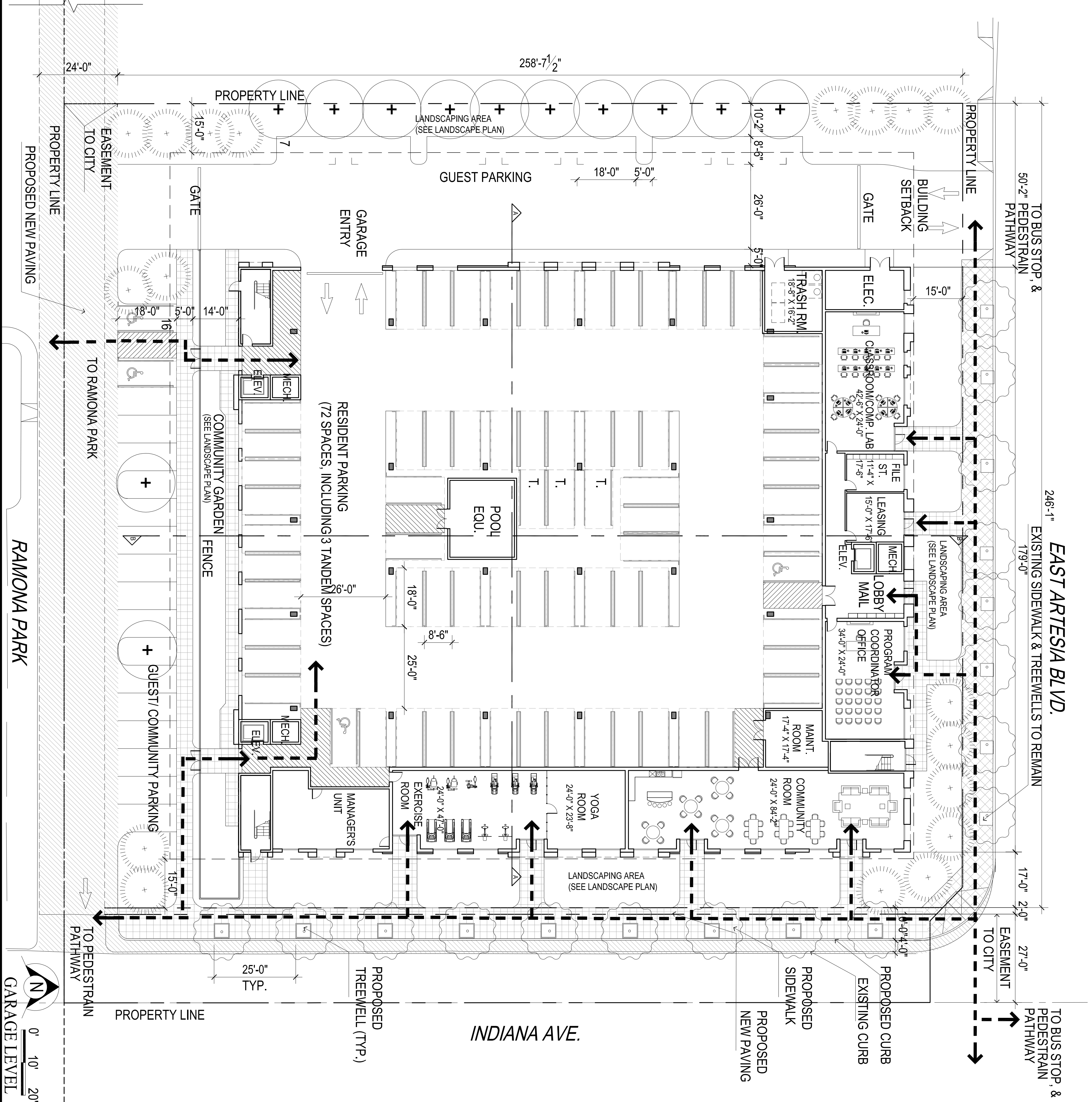

ARTESIA BLVD. SENIOR HOUSING	
TOTAL UNITS :	61 UNITS
LOT SIZE:	1.7 (+/-) ACRE
GROSS DENSITY:	35.9 DU/AC
LOT COVERAGE:	60% (+/-)
TOTAL BUILDING AREA:	70,673 S.F.
F.A.R.:	1.0
COURTYARD:	7,787 S.F.

PARKING	
PARKING REQ.:	72
1/BR FOR RES.	15
1/4 UNITS FOR GUEST:	87
TOTAL:	174
PARKING PROV.:	72 *
GARAGE:	16
SURFACE STD:	7
SURFACE PARALLEL:	95
TOTAL:	174

* NOTE: INCLUDING 3 TANDEM SPACES

BUILDING AREA:				
	GARAGE LEVEL	PODIUM LEVEL	3RD LEVEL	TOTAL
GARAGE	27,627			27,627
COM. SPACES	6,823			6,823
LOBBY/LEASING	1,288			1,288
REC. AREA/ LAU/CLUB		2,210	2,218	4,428
COORDINATOR/STAIR/TRASH		5,339	5,331	10,670
RESIDENTIAL	715	21,076	21,076	42,867
TOTAL	36,453	28,625	28,625	93,703

2-LEVEL RES. ABOVE 1-LEVEL PODIUM									
UNIT	UNIT TYPE	NET S.F.	BAL. S.F.	GR. S.F.	NO.	%	TL. NET	TL. GR. S.F.	
A1	1BR/1BA	589	61	650	44	73%	25,916	26,500	
A2	1BR/1BA	610	78	688	4	7%	2,440	2,752	
B1	2BR/2BA	760	44	804	8	13%	6,080	6,432	
B2	2BR/2BA	972	120	1,092	4	7%	3,888	4,368	
TOTAL					60	100%	38,324	42,152	
AVERAGE UNIT SIZE:				703 S.F.					
MANAGERS UNIT:				715 S.F.					

LEGAL DESCRIPTION:
THE WEST HALF OF LOT 32, BLOCK 28 OF CALIFORNIA COOPERATIVE COLONY TRACT, IN THE CITY OF LONG BEACH, COUNTY OF LOS ANGELES, STATE OF CALIFORNIA, AS PER MAP RECORDED IN BOOK 21 PAGES 15 AND 16 OF MISCELLANEOUS RECORDS, IN THE OFFICE OF THE COUNTY RECORDER OF SAID COUNTY.

EXCEPT THAT PORTION OF SAID LOT DESCRIBED IN THE DEED TO THE STATE OF CALIFORNIA RECORDED ON JULY 12, 1951 AS INSTRUMENT NO. 3205 IN BOOK 36746 PAGE 348, OFFICIAL RECORDS.

ALSO EXCEPTING THE WESTERLY 370.20 FEET OF LOT 32, BLOCK 28 OF CALIFORNIA COOPERATIVE COLONY TRACT, AS PER MAP RECORDED IN BOOK 21 PAGES 15 AND 16 OF MISCELLANEOUS RECORDS, IN THE OFFICE OF THE COUNTY RECORDER OF SAID COUNTY.
APN: 7120-003-034

Site Address:
3290 East Artesia Boulevard, Long Beach, CA

Existing land Use: Commercial Structure, Farmers and Merchants Bank of Long Beach

Proposed Use: Multifamily, Senior Housing

ZONING:
EXISTING: CCA (AUTOMOBILE ORIENTED COMMERCIAL)
REZONE TO R-4-N (HIGH DENSITY RESIDENTIAL)
GENERAL PLAN:
EXISTING: LUD#8 (SHOPPING NODES)
GENERAL PLAN AMENDMENT TO LUD#4 (HIGH DENSITY RESIDENTIAL)

NOTE:
ALL PROPERTY LINES, SETBACKS AND SITE IMPROVEMENTS ARE TO THE BEST OF OUR KNOWLEDGE, AND SHALL BE VERIFIED BY CIVIL ENGINEER.

SITE PLAN
SCALE: 1/16" = 1'-0"
SHEET A-1

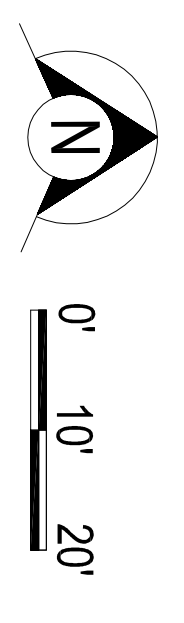
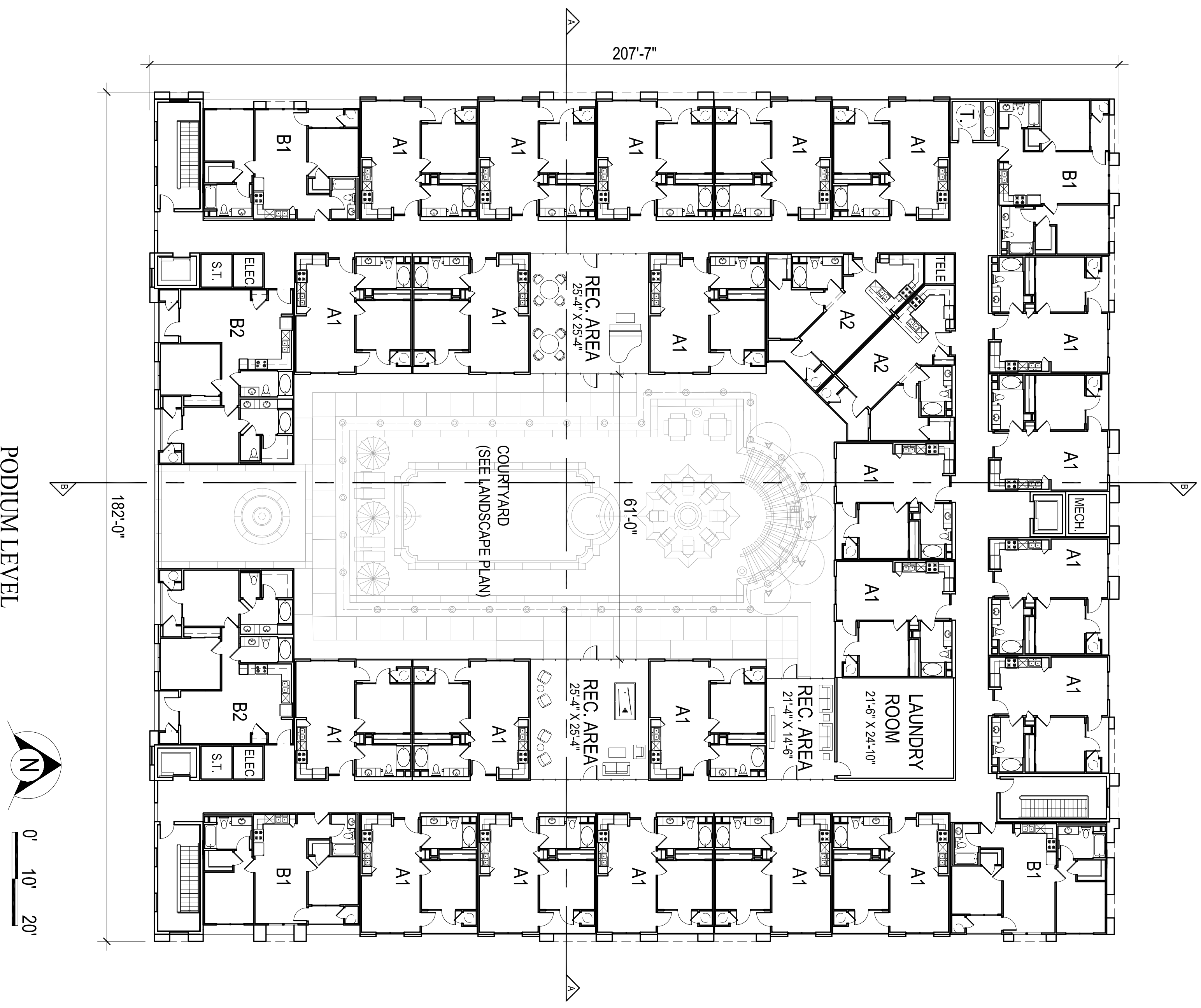
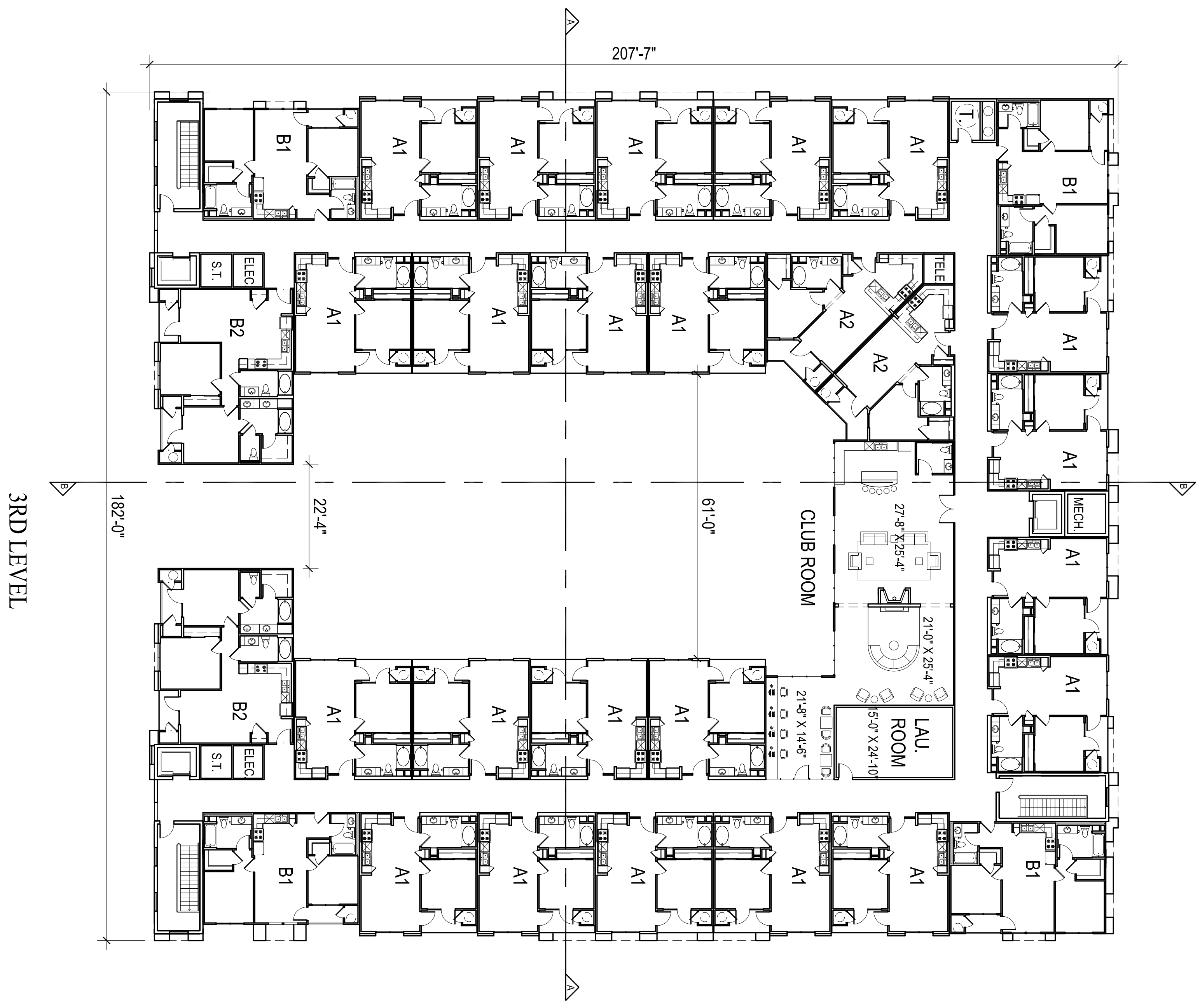

FLOOR PLANS
 SCALE: 1/16" = 1'-0"
 SHEET A-2

© 2008 by HUMPHREYS & PARTNERS ARCHITECTS, L.P.
 The arrangements depicted herein are the sole property of Humphreys & Partners Architects, L.P. and may not be reproduced in any form without its written permission.

Architectural conceptual site plans are for feasibility purpose only. Revisions may occur due to further investigation from regulatory authorities and building code analysis. Dimensions shown are of a strategic intent only. Refer to surveys and civil drawings for technical information and measurements.

ARTESIA BLVD. SENIOR HOUSING
PALM DESERT DEVELOPMENT CO.
 Aug 12, 2009
 LONG BEACH, CA
 HP#08418

HUMPHREYS & PARTNERS ARCHITECTS, L.P.
 5339 Alpha Road, Suite 300 Dallas, TX 75240 (972) 701-9636 (972) 701-9639
 www.humphreys.com marketing@humphreys.com
 DALLAS CHARLOTTE IRVINE LAS VEGAS NEW ORLEANS NORFOLK ORLANDO PHOENIX

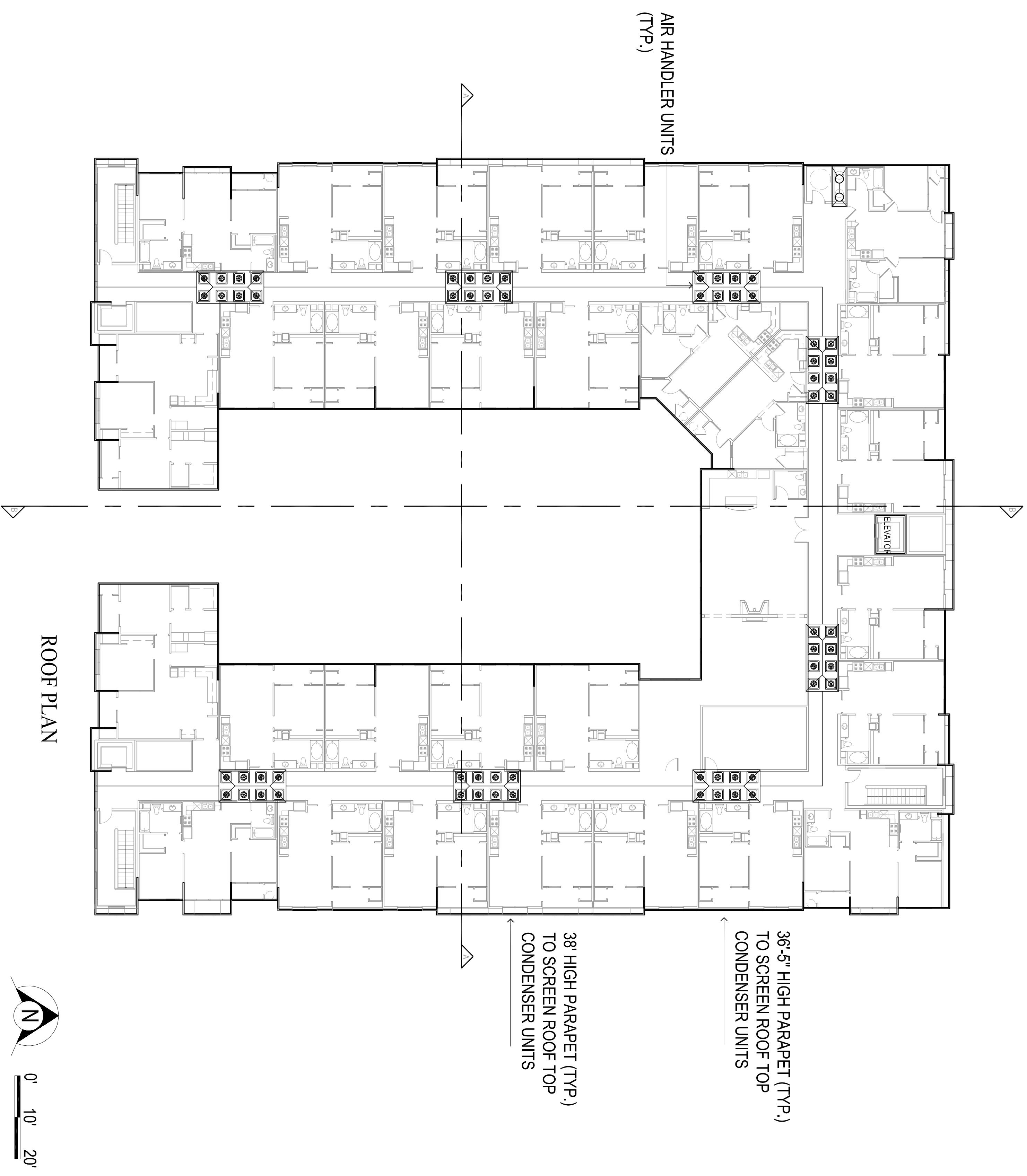

ROOF PLAN

ROOF PLAN
 SCALE: 1/16" = 1'-0"
 SHEET A-3

ARTESIA BLVD. SENIOR HOUSING
PALM DESERT DEVELOPMENT CO.
 LONG BEACH, CA

HPA#08418



HUMPHREYS & PARTNERS ARCHITECTS, L.P.
 5339 Alpha Road, Suite 300 Dallas, TX 75240 (972) 701-9636 (972) 701-9639
 www.humphreys.com marketing@humphreys.com
 DALLAS CHARLOTTE IRVINE LAS VEGAS NEW ORLEANS NORFOLK ORLANDO PHOENIX

© 2008 by HUMPHREYS & PARTNERS ARCHITECTS, L.P.
 The arrangements depicted herein are the sole property of Humphreys & Partners Architects, L.P. and may not be reproduced in any form without its written permission.

Architectural conceptual site plans are for feasibility purpose only. Revisions may occur due to further investigation from regulatory authorities and building code analysis. Dimensions shown are of a strategic intent only. Refer to surveys and civil drawings for technical information and measurements.

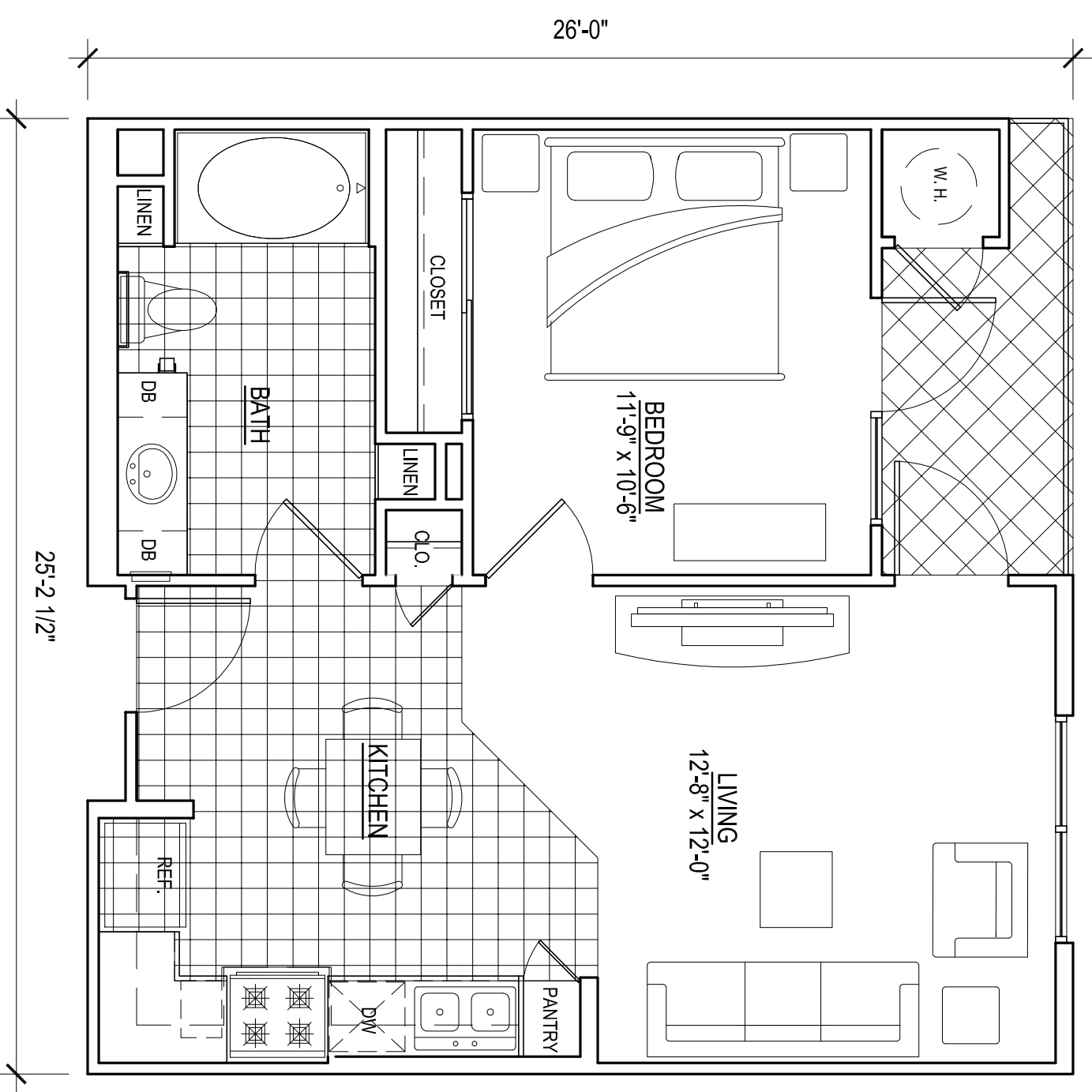

UNIT A1
NET: 680 S.F.
BALCONY: 61 S.F.
SCALE: 1/4"=1'-0"

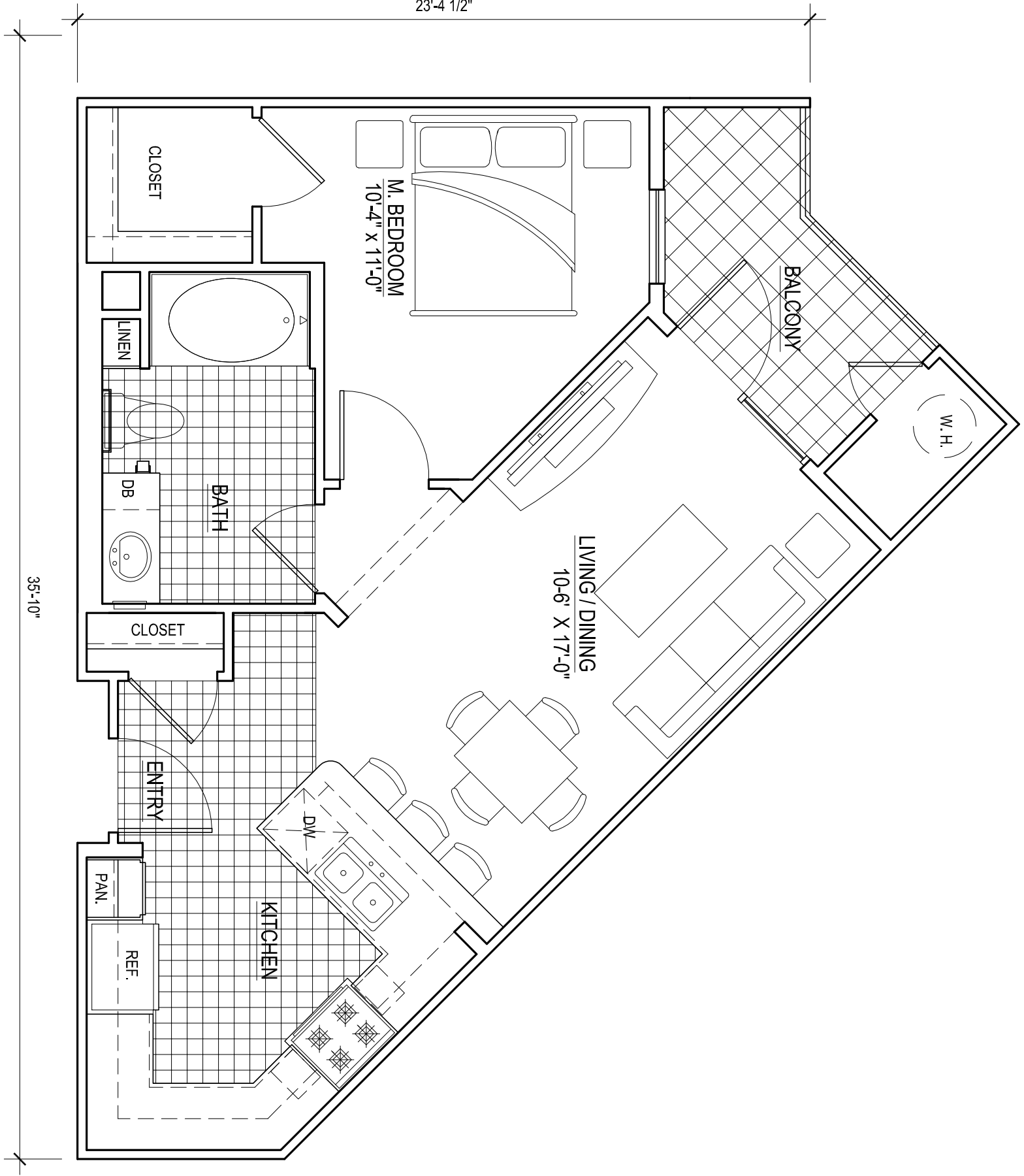

UNIT A2
NET: 610 S.F.
BALCONY: 78 S.F.
SCALE: 1/4"=1'-0"

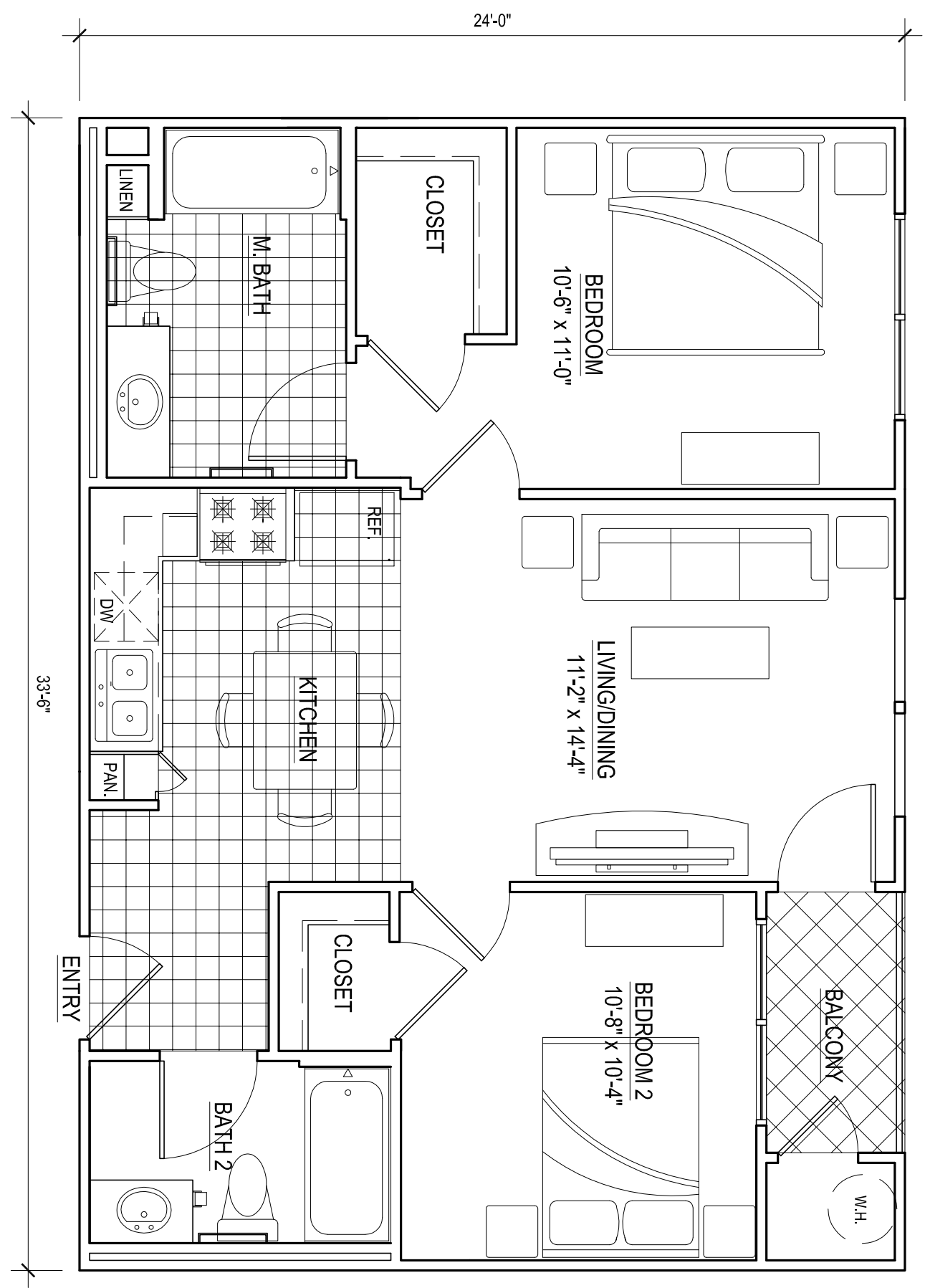

UNIT B1
NET: 780 S.F.
BALCONY: 44 S.F.
SCALE: 1/4"=1'-0"

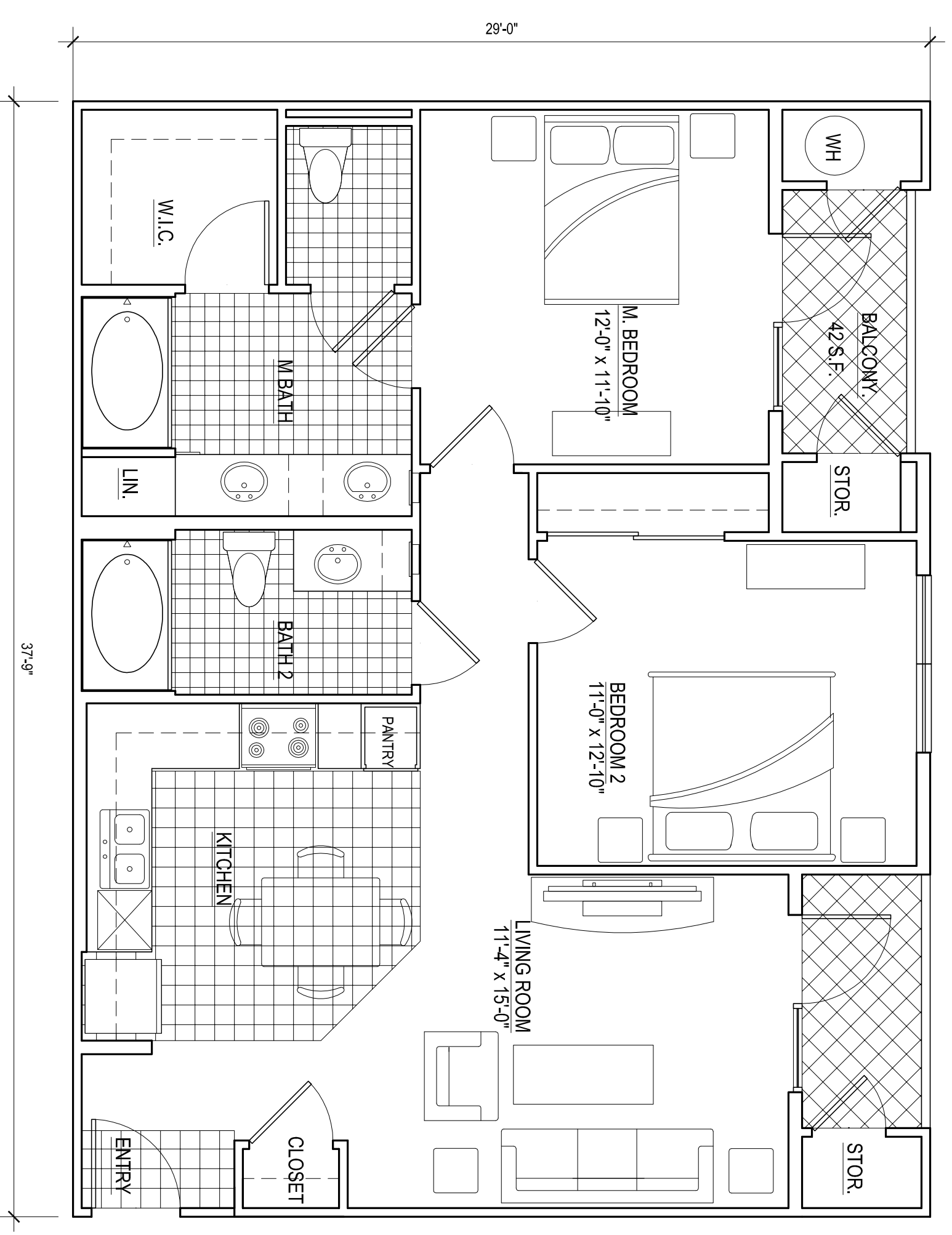

UNIT B2
NET: 972 S.F.
BALCONY/STORAGE: 120 S.F.
SCALE: 1/4"=1'-0"

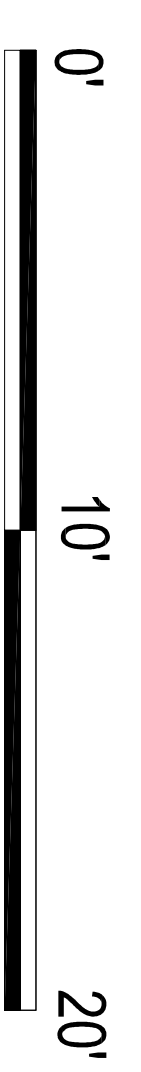

UNIT PLANS
SCALE: 1/4"=1'=0"
SHEET A-4

ARTESIA BLVD. SENIOR HOUSING

PALM DESERT DEVELOPMENT CO.

Aug 12, 2009

LONG BEACH, CA

HPA#08418



HUMPHREYS & PARTNERS ARCHITECTS L.P.
5339 Alpha Road, Suite 300 Dallas, TX 75240 (972) 701-9636 (972) 701-9639
www.humphreys.com marketing@humphreys.com
DALLAS CHARLOTTE IRVINE LAS VEGAS NEW ORLEANS NORFOLK ORLANDO PHOENIX

© 2008 by HUMPHREYS & PARTNERS ARCHITECTS, LP
The arrangements depicted herein are the sole property of Humphreys & Partners Architects, LP and may not be reproduced in any form without its written permission.
Architectural conceptual site plans are for feasibility purpose only. Revisions may occur due to further investigation from regulatory authorities and building code analysis. Dimensions shown are of a strategic intent only. Refer to surveys and civil drawings for technical information and measurements.

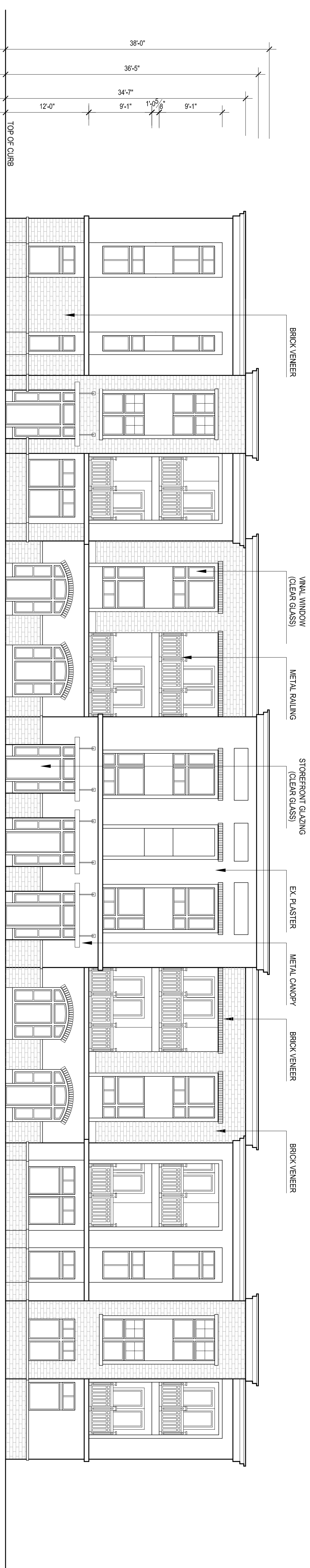

NORTH ELEVATION
(ALONG EAST ARTESIA BLVD.)
SCALE: 1/8" = 1'-0"



EAST ELEVATION
(ALONG INDIANA AVE.)
SCALE: 1/8" = 1'-0"



ELEVATIONS
SHEET A-5

©2008 by HUMPHREYS & PARTNERS ARCHITECTS, LP
The arrangements depicted herein are the sole property of Humphreys & Partners Architects, LP and may not be reproduced in any form without its written permission.

Architectural conceptual site plans are for feasibility purpose only. Revisions may occur due to further investigation from regulatory authorities and building code analysis. Dimensions shown are of a strategic intent only. Refer to surveys and civil drawings for technical information and measurements.

ARTESIA BLVD. SENIOR HOUSING

PALM DESERT DEVELOPMENT CO.

Aug 12, 2009

LONG BEACH, CA

HPA#08418



HUMPHREYS & PARTNERS ARCHITECTS L.P.

5339 Alpha Road, Suite 300 Dallas, TX 75240 (972) 701-9636 (972) 701-9639
www.humphreys.com marketing@humphreys.com
DALLAS CHARLOTTE IRVINE LAS VEGAS NEW ORLEANS NORFOLK ORLANDO PHOENIX

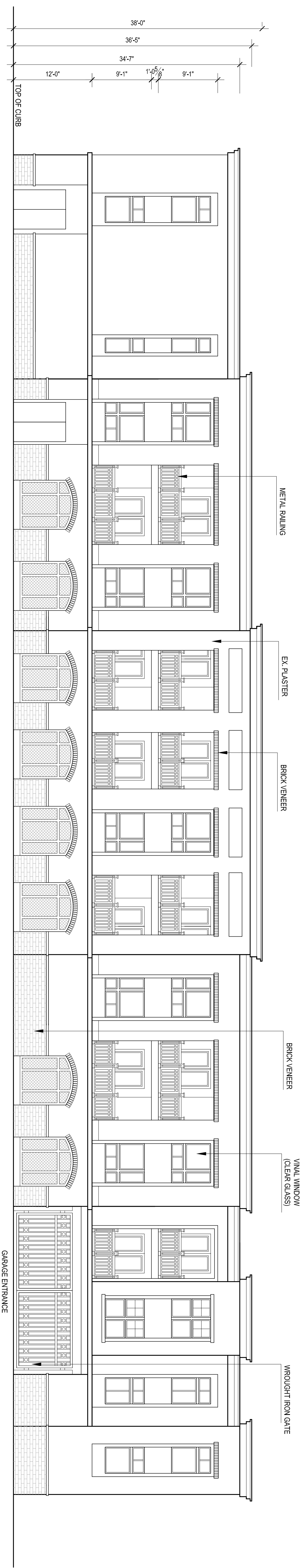

WEST ELEVATION
SCALE: 1/8" = 1'-0"



SOUTH ELEVATION
(FACING RAMONA PARK)
SCALE: 1/8" = 1'-0"

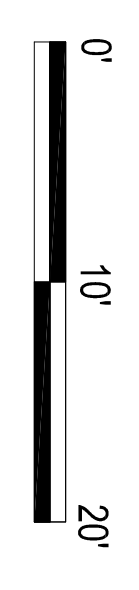

ELEVATIONS
SHEET A-6

© 2008 by HUMPHREYS & PARTNERS ARCHITECTS, LP
The arrangements depicted herein are the sole property of Humphreys & Partners Architects, LP and may not be reproduced in any form without its written permission.

Architectural conceptual site plans are for feasibility purpose only. Revisions may occur due to further investigation from regulatory authorities and building code analysis. Dimensions shown are of a strategic intent only. Refer to surveys and civil drawings for technical information and measurements.

ARTESIA BLVD. SENIOR HOUSING

PALM DESERT DEVELOPMENT CO.
LONG BEACH, CA
HPA#08418



HUMPHREYS & PARTNERS ARCHITECTS L.P.
5539 Alpha Road, Suite 300 Dallas, TX 75240 (972) 701-9636 (972) 701-9639
www.humphreys.com marketing@humphreys.com
DALLAS CHARLOTTE IRVINE LAS VEGAS NEW ORLEANS NORFOLK ORLANDO PHOENIX



SECTION B



SECTION A

SECTIONS
SCALE: 1/8" = 1'-0"
SHEET A-7

© 2008 by HUMPHREYS & PARTNERS ARCHITECTS, LP
The arrangements depicted herein are the sole property of Humphreys & Partners Architects, LP and may not be reproduced in any form without its written permission.

Architectural conceptual site plans are for feasibility purpose only. Revisions may occur due to further investigation from regulatory authorities and building code analysis. Dimensions shown are of a strategic intent only. Refer to surveys and civil drawings for technical information and measurements.

ARTESIA BLVD. SENIOR HOUSING
PALM DESERT DEVELOPMENT CO.
LONG BEACH, CA
Aug 14, 2009

HPA#08418



HUMPHREYS & PARTNERS ARCHITECTS, L.P.
5339 Alpha Road, Suite 300 Dallas, TX 75240 (972) 701-9636 (972) 701-9639
www.humphreys.com marketing@humphreys.com
DALLAS CHARLOTTE IRVINE LAS VEGAS NEW ORLEANS NORFOLK ORLANDO PHOENIX

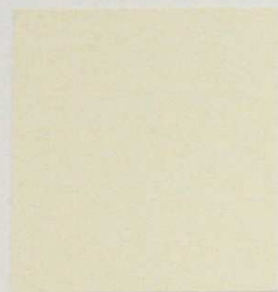

1



2



3



4

5

9



6

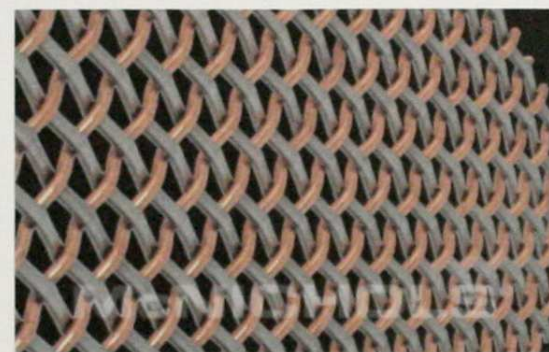

8



10



7



NORTH ELEVATION (ALONG EAST ARTESIA BLVD.)



SOUTH ELEVATION (FACING RAMONA PARK)

EX. PLASTER:

- 1. Dunn Edwards - Natural Wool - DE5441
- 2. Dunn Edwards - Floating Lily Pad - DE5493
- 3. Dunn Edwards - Rich Mocha - DEA159
- 4. Vinal window - IWC ColorCoat 920
- 5. Store Front Metal Frame - IWC ColorCoat 920

- 6. Coronado Stone- Wirecut Brick - La Jolla Blend
- 7. Metal Railing/Canopy - Dunn Edwards - Rich Mocha- DEA159
- 8. Metal Mesh - McNichols - Wire Mesh - Shire 8148
- 9. Metal Frame - IWC ColorCoat 920
- 10. Enlarged Parking Screen - IWC Metal Frame with Metal Mesh

MATERIAL BOARD

**ARTESIA BLVD. SENIOR HOUSING
PALM DESERT DEVELOPMENT CO.**

AUGUST 10, 2009

LONG BEACH, CA

HPA#08418



HUMPHREYS & PARTNERS ARCHITECTS L.P.

5339 Alpha Road, Suite 300 Dallas, TX 75240 (972) 701-9636 (972) 701-9639

www.humphreys.com marketing@humphreys.com

DALLAS CHARLOTTE IRVINE LAS VEGAS NEW ORLEANS NORFOLK ORLANDO PHOENIX

© 2008 by HUMPHREYS & PARTNERS ARCHITECTS, LP
The arrangements depicted herein are the sole property of Humphreys & Partners Architects, LP and may not be reproduced in any form without its written permission.
Architectural conceptual site plans are for feasibility purpose only. Revisions may occur due to further investigation from regulatory authorities and building code analysis. Dimensions shown are of a strategic intent only. Refer to surveys and civil drawings for technical information and measurements.

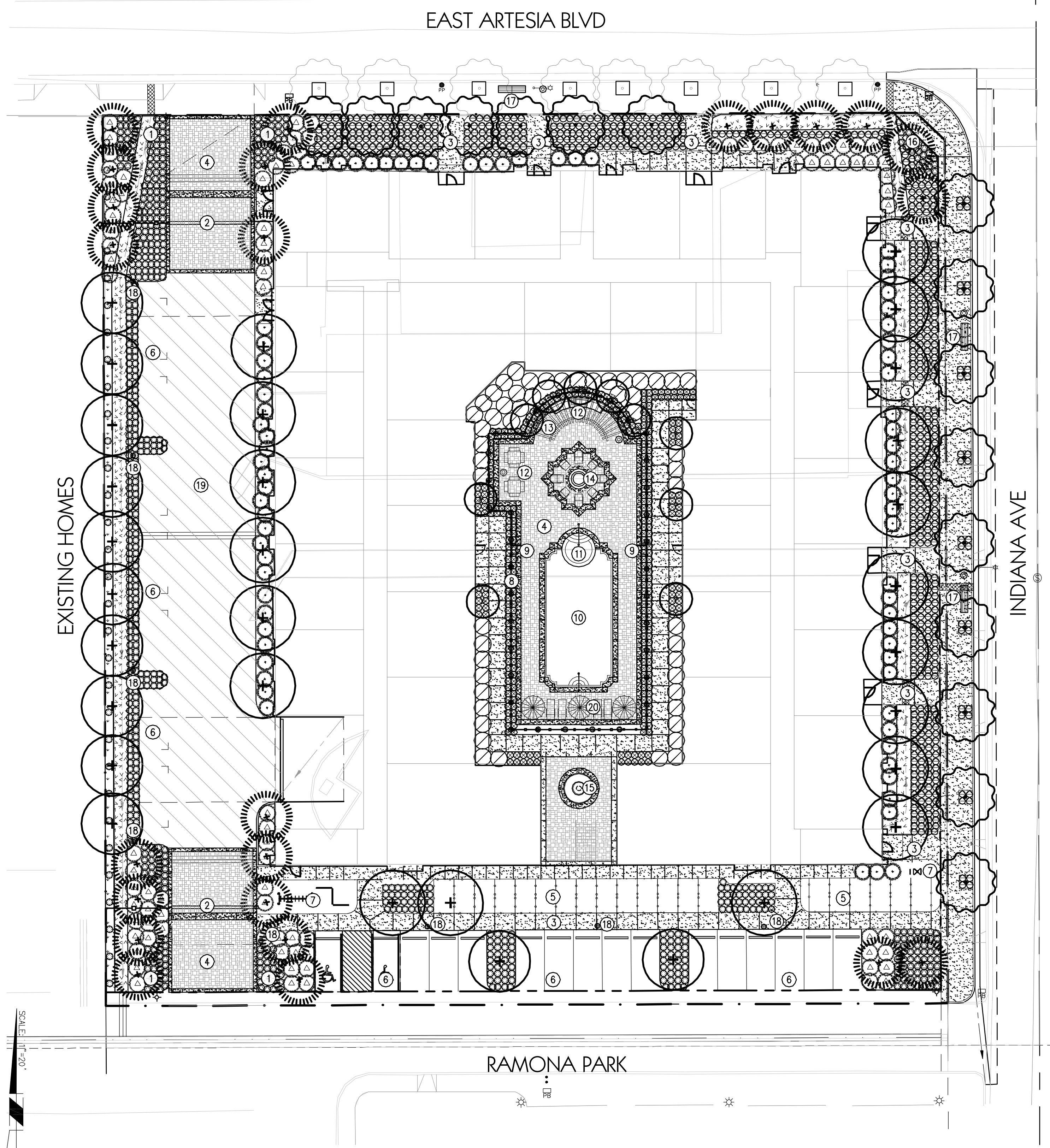

PLANTING LEGEND

- EAST ARTESIA BLVD/INDIANA AVE TREES (24" BOX MIN.), SUCH AS: GELERA PARVIFLORA- AUSTRALIAN WILLOW JACARANDA MIMOSIFOLIA - JACARANDA TRISTANIA CONFERTA- WATER GUM
- SHRUBS (5 GALLON MIN.), SUCH AS: LIGUSTRUM JAPONICUM- JAPANESE PRIVET PHOTINIA FRAZERI- PHOTNIA VIBURNUM TINUS- LAURUSTINUS
- GROUND COVERS (1 GALLON MIN), SUCH AS: CARISSA MACROCARPA- NATAL PLUM FESTUCA GLAUCA- COMMON BLUE FESCUE MUHLLENBERGIA SPECIES- ORNAMENTAL GRASS NASSELLA PULCHRA- MEXICAN FEATHER GRASS PENNSETUM SETACEUM- FOUNTAIN GRASS RHAPHIOLEPIS INDICA- INDIAN HAWTHORN TRACHELOSPERMUM JASMINOIDES- STAR JASMINE
- ENTRY STATEMENT TREES (24" BOX MIN.), SUCH AS: JACARANDA MIMOSIFOLIA- JACARANDA LAGERSTROEMIA INDICA- CREPE MYRTLE
- SHRUBS (5 GALLON MIN), SUCH AS: HEMEROCALLIS- DAY LILY PHORAMILUM TENAX- NEW ZEALAND FLAX STRELITZIA REGINAE- BIRD OF PARADISE
- GROUND COVERS (1 GALLON MIN), SUCH AS: BOUGAINVILLEA- BOUGAINVILLEA LANTANA MONTEVIDENSIS- LANTANA ROSA X CARPET- CARPET ROSE
- RESIDENCE FOUNDATION TREES (24" BOX MIN.), SUCH AS: GELERA PARVIFLORA- AUSTRALIAN WILLOW LIQUIDAMBAR STYRACIFLUA- AMERICAN SWEET GUM OLEA EUROPAEA FRUITLESS- OLIVE PLATANUS ACERIFOLIA- LONDON PLANE TREE
- GROUND COVERS (1 GALLON MIN), SUCH AS: CARISSA MACROCARPA- NATAL PLUM RAPHIOLEPIS INDICA, BALLERINA- INDIAN HAWTHORN TRACHELOSPERMUM JASMINOIDES- STAR JASMINE
- VINES (5 GALLON MIN), SUCH AS: BOUGAINVILLEA- BOUGAINVILLEA DISTICTIS BULLINATOR- BLOOD RED TRUMPET VINE
- COURTYARD TREES (24" BOX MIN.), SUCH AS: BALUHINIA X BLAKEANA- HONG KONG ORCHID TREE ENSETE RENTRICOSUM- ABYSSINIAN BANANA FICUS BENJAMINA- BENJAMIN FIG
- SHRUBS (5 GALLON MIN), SUCH AS: BUXUS MICROPHYLLA- BOXWOOD CANNA- CANNA STRELITZIA REGINAE- BIRD OF PARADISE
- GROUND COVERS (1 GALLON MIN), SUCH AS: IMPATIENS WALLERIANA- IMPATIENS LIMONIUM PEREZII- SEA LAVENDER LIRIOPE MUSCARI- TURF LILY VINCA MINOR- DWARF PERWINKLE
- VINES (5 GALLON MIN), SUCH AS: BOUGAINVILLEA- BOUGAINVILLEA PASSIFLORA X BELOTHI- PASSION FLOWER
- BIOSWALE TURF GRASS
- EXISTING TREE TO REMAIN AND BE PROTECTED IN PLACE

KEY NOTES

- 1 ENTRY ENHANCEMENT
- 2 DECORATIVE ENTRY GATE
- 3 PEDESTRIAN WALKWAY
- 4 DECORATIVE PAVEMENT
- 5 FENCED COMMUNITY GARDENS
- 6 PARKING LOTS
- 7 WORKOUT STATION
- 8 6' TUBULAR STEEL POOL FENCE
- 9 POOL GATE
- 10 SWIMMING POOL
- 11 SPA
- 12 BBQ & PICNIC TABLES
- 13 SHADE TRELLIS
- 14 FIR PIT
- 15 FOUNTAIN
- 16 MONUMENT SIGN
- 17 BENCH/ TRASH RECEPTACLE
- 18 LIGHTING FIXTURE PER CITY STD TYPE G
- 19 COLOR CONCRETE PAVING
- 20 UMBRELLA & SEATING

LANDSCAPE NOTES

1. ALL LANDSCAPING AND IRRIGATION SYSTEMS SHALL BE DESIGNED, INSTALLED AND MAINTAINED IN ACCORDANCE WITH THE REQUIREMENTS OF ALL APPLICABLE CODES AND STANDARDS OF THE CITY OF LONG BEACH
2. TREES SHALL NOT BE PLANTED WHERE THEY INTERFERE WITH SITE DRAINAGE OR REQUIRE FREQUENT PRUNING IN ORDER TO AVOID INTERFERENCE WITH OVERHEAD UTILITY LINES
3. TREE SIZES SHALL BE PLANTED IN ACCORDANCE WITH CITY REQUIREMENTS
4. A 3" LAYER OF ORGANIC MULCH SHALL BE APPLIED TO ALL SHRUB PLANTING AREAS
5. ALL TREES PLANTED WITHIN FIVE FEET OF A PAVED SURFACE SHALL BE INSTALLED WITH A ROOT BARRIER
6. ALL ABOVE GROUND UTILITIES SHALL BE SCREENED FROM VIEW OF THE PUBLIC STREET WITH AN EVERGREEN TREES AND SHRUBS, TO GREATEST EXTENT POSSIBLE
7. ALL LANDSCAPE AREAS SHALL BE IRRIGATED WITH AN ELECTRONICALLY OPERATED, REMOTE CONTROLLED IRRIGATION SYSTEM UTILIZING STATE OF THE ART TECHNOLOGY. THE SYSTEM SHALL BE DESIGNED IN ACCORDANCE WITH STATE IRRIGATION STANDARDS (AB325), SHALL APPLY WATER EFFICIENTLY, AVOID OVERSPRAY ON TO BUILDING AND PAVEMENT AND MINIMIZE RUNOFF

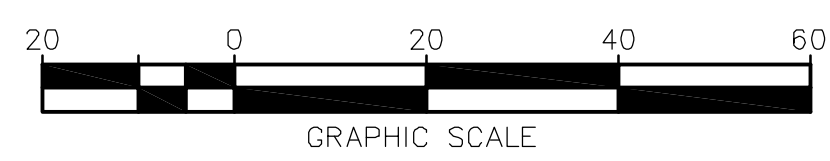

DEVELOPER: PALM DESERT DEVELOPMENT COMPANY
 CONTACT: JEFFREY TARTAGLINO
 P.O. BOX 3859
 PALM DESERT, CA 92261
 TEL: 760.588.1048

NO.	DATE	REVISIONS	APP'D	DATE

JOB NO.: 10-10-6842
 SCALE: 1"=20'
 DATE: 8/11/09
 DESIGNED BY: JA/NW

RBF CONSULTING PLANNING ■ DESIGN ■ CONSTRUCTION
 14725 ALTON PARKWAY IRVINE, CALIFORNIA 92618-2027
 949.472.3505 • FAX 949.472.8122 • www.RBF.com

PLAN TITLE FOR
ARTESIA BLVD SENIOR HOUSING LONG BEACH
CONCEPTUAL LANDSCAPE PLAN

SHEET **3** OF 3 SHTS.

P:\DATA\10106842\CADD\LAND\01\CONCEPTUAL\0842-09-001.DWG TMEIS 5/29/09 8:33 am

ARTESIA BLVD.

INDIANA AVE

SENIOR HOUSING BUILDING GARAGE LEVEL
FF +59.00

RAMONA PARK

LEGEND

- DOWNDRAIN
- 2' RIBBON GUTTER
- PARKWAY DRAIN UNDER SIDEWALK/WALKWAY
- PROP. TREE WELL
- LANDSCAPING
- ASPHALT CONCRETE
- AGGREGATE BASE
- CURB FACE
- CENTER LINE
- EASEMENT
- EXISTING
- FLOW LINE
- FINISHED SURFACE
- GRADE BREAK
- HIGH POINT
- TOP OF CURB
- PROPERTY LINE
- PROPOSED
- RIGHT OF WAY

SURVEY LEGEND

- WATER METER
- TRAFFIC PULLBOX
- TREE
- UTILITY PULLBOX
- STREET LIGHT
- SEWER MANHOLE
- SIGN
- POWER POLE
- IRRIGATION CONTROL BOX
- GUY WIRE
- GAS METER
- EASEMENT
- SURVEY FOUND MONUMENT
- SURVEY CONTROL POINT
- BOLLARD
- AREA LIGHT

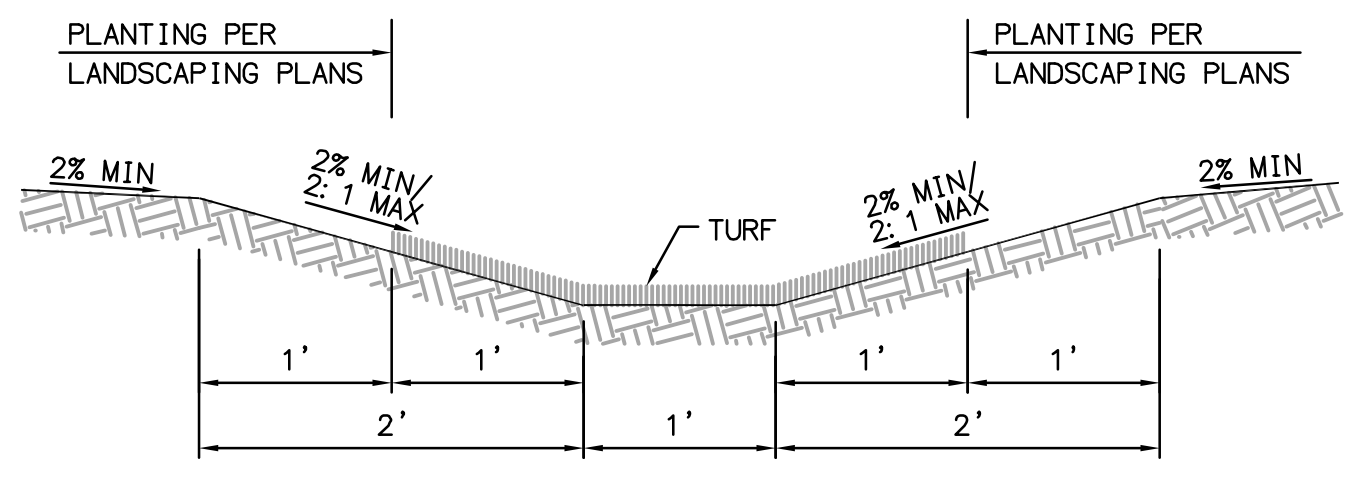

DETAIL CROSS-SECTION BIOSWALE

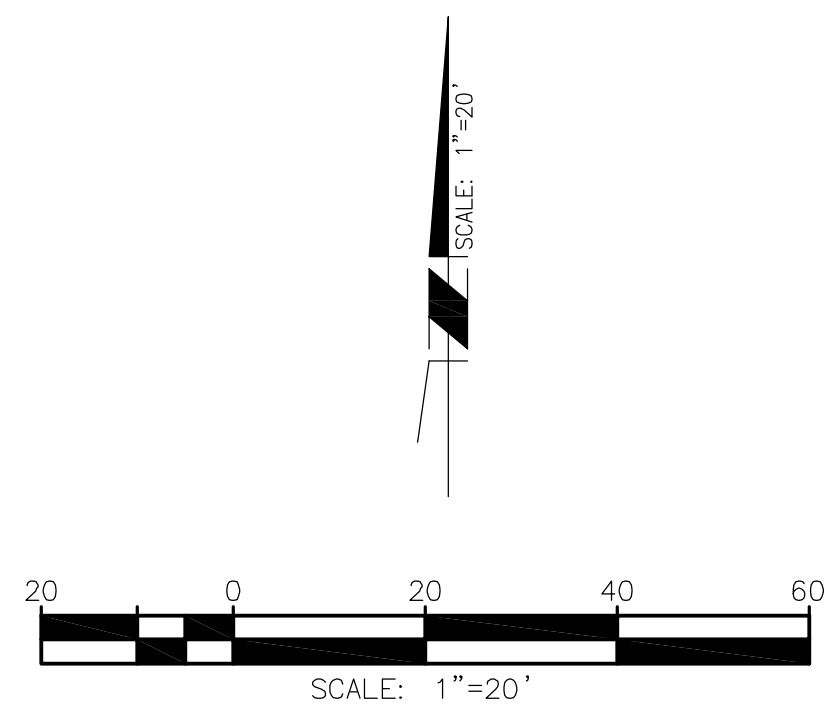

NOTE:
FOR PAVING PLAN SEE SHEET 2
FOR LANDSCAPE PLAN SEE SHEET 3

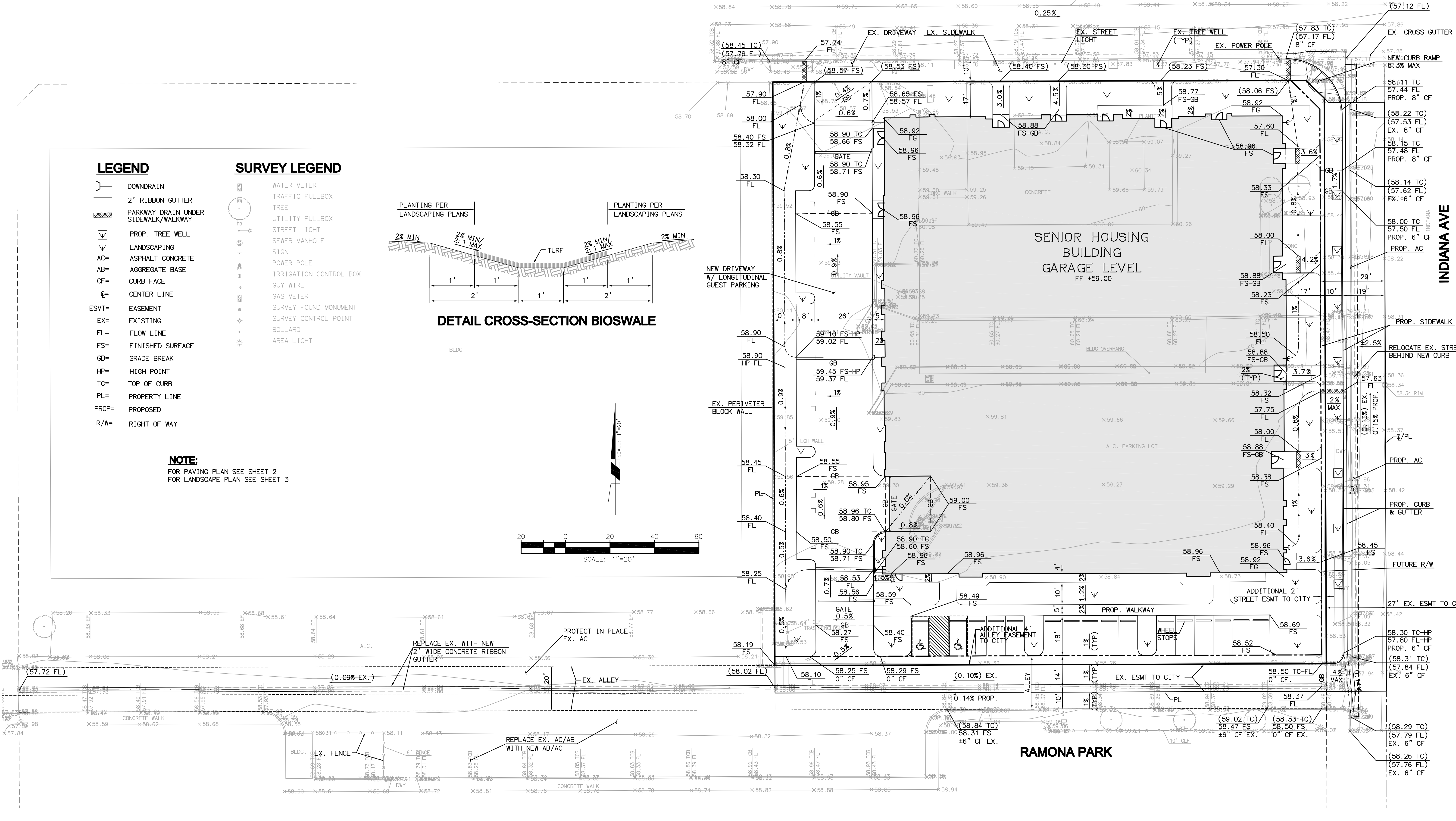

DEVELOPER: PALM DESERT DEVELOPMENT COMPANY
CONTACT: JEFFREY TARTAGLINO
P.O. BOX 3969
PALM DESERT, CA 92261
TEL: 760.588.1048



NO.	DATE	REVISIONS	APP'D	DATE

JOB NO.: 10-10-6842
SCALE: 1"=20'
DATE: 8/11/09
DESIGNED BY: DK/TM

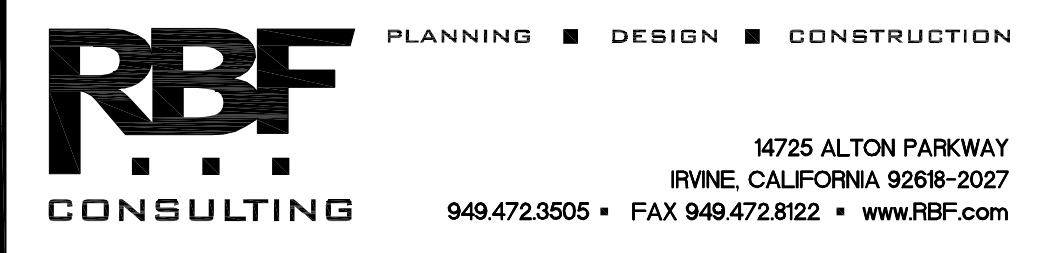

PLAN TITLE FOR
ARTESIA BLVD SENIOR HOUSING LONG BEACH

CONCEPTUAL GRADING PLAN

SHEET **1** OF 3 SHTS.





ARTESIA BLVD.

INDIANA
INDIANA AVE



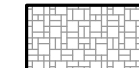











SENIOR HOUSING
BUILDING
GARAGE LEVEL

RAMONA PARK

LEGEND

-  DECORATIVE PAVEMENT/
STONE PAVERS
-  CONCRETE DRIVEWAY, ALLEY,
PARKING, GUTTER - 5" PCC OVER
95% COMPACTED NATIVE SOIL,
REBAR #4@ 18" O.C.
-  CONCRETE SIDEWALK,
WALKWAY - 4" PCC OVER 95%
COMPACTED NATIVE SOIL
-  ASPHALT PAVEMENT -
3.5" ASPHALT CONCRETE
OVER 5.5" AGGREGATE BASE
- PCC = PORTLAND CEMENT CONCRETE

SURVEY LEGEND

-  WATER METER
-  TRAFFIC PULLBOX
-  TREE
-  UTILITY PULLBOX
-  STREET LIGHT
-  SEWER MANHOLE
-  SIGN
-  POWER POLE
-  IRRIGATION CONTROL BOX
-  GUY WIRE
-  GAS METER
-  SURVEY FOUND MONUMENT
-  SURVEY CONTROL POINT
-  BOLLARD
-  AREA LIGHT

NOTE:
FOR GRADING PLAN SEE SHEET 1
FOR LANDSCAPE PLAN SEE SHEET 3

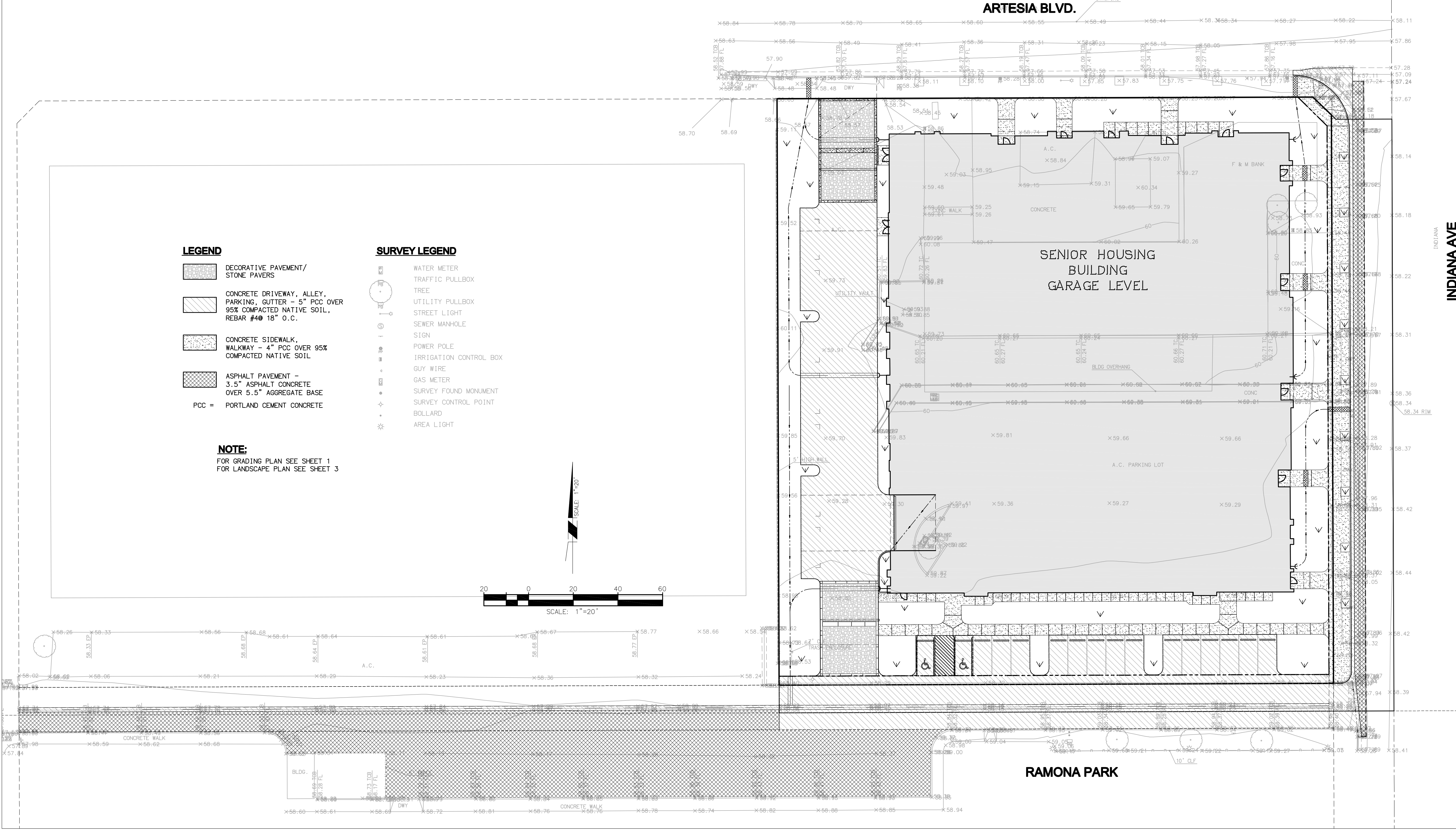
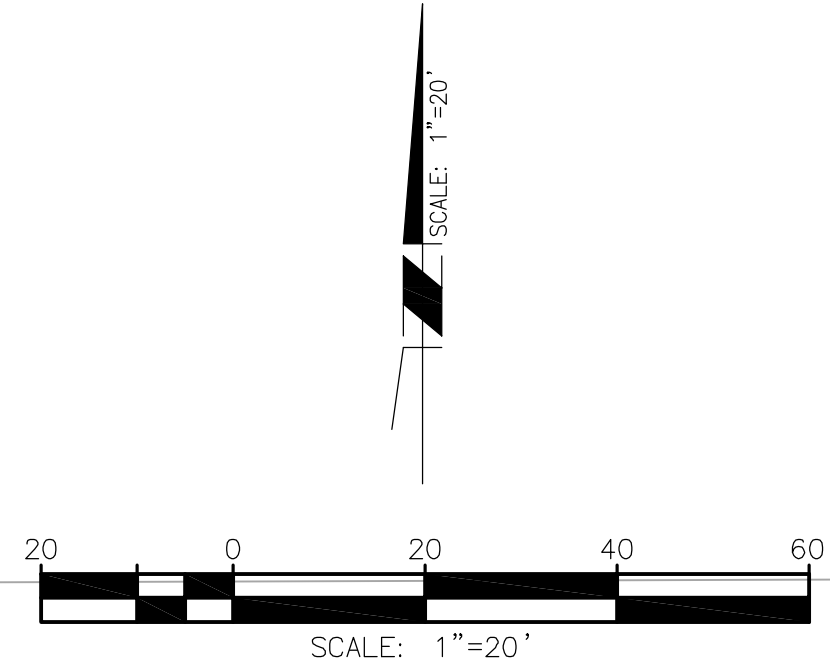

DEVELOPER: PALM DESERT DEVELOPMENT COMPANY
CONTACT: JEFFREY TARTAGLINO
P.O. BOX 3969
PALM DESERT, CA 92261
TEL: 760.588.1048



NO.	DATE	REVISIONS	APP'D	DATE

JOB NO.:
10-10-6842
SCALE:
1"=20'
DATE:
8/11/09
DESIGNED BY:
DK/JM

RBF CONSULTING
PLANNING ■ DESIGN ■ CONSTRUCTION
14725 ALTON PARKWAY
IRVINE, CALIFORNIA 92618-2027
949.472.2605 • FAX 949.472.8122 • www.RBF.com

PLAN TITLE FOR
**ARTESIA BLVD SENIOR HOUSING
LONG BEACH**
CONCEPTUAL PAVING PLAN

SHEET
2
OF 3 SHTS.

P:\DATA\10106842\CAD\LAND\CONCEPTUAL\8642-GR-002.DWG -MURRAY - 8/11/09 2:50 PM

CONDITIONS OF APPROVAL
Application No.0812-13
Date: February 4, 2010

1. This approval is to allow an amendment to the General Plan from Land Use Designation No. 8N to 4 and a rezone from CCA to CCN at 3232 and 3290 E. Artesia Blvd. The change in zone will allow for the construction of a 3-story, 61-unit affordable senior apartment building with 89 parking spaces at 3290 E. Artesia Blvd within the CCN Zoning District.
2. This permit and all development rights hereunder shall terminate one year from the effective date (final action date or, if in the appealable are of the Coastal Zone, 21 days after the local final action date) of this permit unless construction is commenced, a business license establishing the use is obtained or a time extension is granted, based on a written and approved request submitted prior to the expiration of the one year period as provided in Section 21.21.406 of the Long Beach Municipal Code.
3. This permit shall be invalid if the owner(s) and applicant(s) have failed to return written acknowledgment of their acceptance of the conditions of approval on the *Conditions of Approval Acknowledgment Form* supplied by the Planning Bureau. This acknowledgment must be submitted within 30 days form the effective date of approval (final action date or, if in the appealable area of the Coastal Zone, 21 days after the local final action date). Prior to the issuance of a building permit, the applicant shall submit a revised set of plans reflecting all of the design changes set forth in the conditions of approval to the satisfaction of the Zoning Administrator.
4. If, for any reason, there is a violation of any of the conditions of this permit or if the use/operation is found to be detrimental to the surrounding community, including public health, safety or general welfare, environmental quality or quality of life, such shall cause the City to initiate revocation and termination procedures of all rights granted herewith.
5. All conditions of approval must be printed verbatim on all plans submitted for plan review to the Director of Development Services. These conditions must be printed on the site plan or a subsequent reference page.

SPECIAL CONDITIONS

6. The applicant shall comply with the following conditions to the satisfaction of the Director of Development Services:
 - a. The applicant shall repave the entire length of the alley south of the property, to the satisfaction of the Director of Public Works.
 - b. The applicant shall create a car-sharing program with fuel-efficient cars and/or provide a minimum of one, a rental car for group use in the parking garage.
 - c. Prior to the issuance of a building permit, the applicant shall demonstrate to the

satisfaction of the Director of Development Services that all best efforts have been undertaken to achieve LEED certification for the Affordable Senior Apartment Building and all newly implemented Green Building Standards enumerated in Section 21.45.400.

- d. Prior to the issuance of any building permits, the applicant shall demonstrate on the final project plans that minimally reflective glass and other building materials will be incorporated on the building exteriors in order to reduce reflective glare. The use of glass with exterior daylight reflectance of more than twenty percent (20%) is prohibited.
- e. All mature trees removed from the site during demolition, shall be replaced with mature canopy trees.

MITIGATION MEASURES

7. Prior to the issuance of a building permits, the City shall ensure that the project Proponent shall submit a lighting plan to ensure that light and glare does not impact nearby residential land uses. The lighting plan shall indicate outdoor lighting levels of all security lights and the light levels at the property lines. All exterior security lights must be shielded and directed downward in such a manner so as to minimize light spillover effects.
8. Any proposed fire pits shall be prohibited from burning wood. The fire pits shall be powered by natural gas, propane, and/or electricity.
9. Prior to the issuance of a demolition permit, and in consultation with the Director of Developmental Services or their designee, an historic preservation professional qualified in accordance with the Secretary of Interior Standards shall be selected to complete Documentation Reports on the eligible property to be demolished. The property determined to be eligible for City Landmark listing shall be documented with archival quality photographs of a type and format approved by the Director or their designee. The recordation document shall be completed and approved to the satisfaction of the Director or their designee. The approved document, along with historical background of the properties, shall be submitted to an appropriate repository approved by the Director or their designee.
10. To be consistent with goals in the Long Beach Sustainable City Action Plan, the following measures shall be incorporated into the project and verified by a City of Long Beach representative prior to occupancy:
 - Create a car-sharing program with fuel efficient cars (greater than 40 miles per gallon) and/or provide a minimum of one Zipcar, a rental car for group use (or equivalent) in the parking garage (www.zipcar.com);
 - Provide information to the residents on how to use the transit system, including details on where the bus stops are located, route information, how to plan a bus trip, and potential destinations;
 - Install short-term bicycle parking within 100 feet of the main entrance(s);
 - There shall be room onsite for convenient storage for resident recyclables;
 - The project shall implement a green roof system or install solar panels on the roof to cover three percent of the project's energy use.

- The project shall plant a minimum of five onsite trees.
11. The following Leadership for Energy and Environmental Design (LEED) credits in the LEED for Homes Rating System dated January 2008 (or equivalent in subsequent version) shall be complied with:
 - Sustainable Sites 2, landscaping, (minimum of four points);
 - Sustainable Sites 3, reduce local heat island effects;
 - Sustainable Sites 4.1, permeable lot;
 - Sustainable Sites 4.3, management of run-off from roof;
 - Water Efficiency 2, irrigation system;
 - Materials and Resource 3.2, construction waste reduction;
 - Energy and Atmosphere 1.2, exceptional energy performance (2 points minimum)
 - Energy and Atmosphere 9.1, high-efficiency appliances; and
 - Energy and Atmosphere 9.2, water efficient clothes washer.
 12. Compliance with SCAQMD Rule 1403 requires that the owner or operator of any demolition or renovation activity to have a survey for asbestos containing materials (ACMs) performed prior to demolition. Any ACMs found must be remediated according to applicable standards to protect public health and safety. Testing for and any remediation of ACMs must occur before demolition permits are granted by the City for this project.
 13. Lead-based paint (LBP) exposure is regulated by California Occupational Safety and Health Administration (Cal OSHA) regulations. California Code of Regulations, §1532.1, requires testing, monitoring, containment, and disposal of LBP such that exposure levels do not exceed Cal OSHA standards. Testing for and any remediation of LBP must occur before demolition permits are granted by the City for this project.
 14. Prior to the issuance of building permits, an acoustical report must be submitted, reviewed, and approved by City of Long Beach Staff, in order to ensure that City noise requirements are met. Such report shall be prepared to the satisfaction of City Staff and shall, if necessary, include recommended measures to reduce noise exposures for residences to acceptable levels.
 15. Construction activities shall adhere to the following noise requirements:
 - All construction equipment shall utilize noise reduction features (e.g., mufflers and engine shrouds) that are no less effective than those originally installed by the manufacturer.
 - Hours of construction shall comply with those established in the City of Long Beach Municipal Code construction activity noise regulations. Those hours are 7:00 PM and 7:00m AM on any weekday, 9:00 AM to 6:00 PM on Saturdays and is prohibited on Sundays.
 16. At the time the grading permit application is submitted, the project proponent shall submit a construction noise mitigation plan to the City of Long Beach for review and approval. The plan shall depict the location of construction

equipment and describe how noise would be mitigated through methods such as, but not limited to, locating stationary noise-generating equipment (such as pumps and generators), as far as possible from nearby noise-sensitive receptors. Where practicable, noise-generating equipment shall be shielded from nearby noise-sensitive receptors by noise-attenuating buffers such as structures or haul trucks trailers. Onsite noise sources such as heavy equipment located less than 200 feet from noise-sensitive receptors shall be equipped with noise-reducing engine housings. Portable acoustic barriers able to attenuate at least six dBA shall be placed around noise-generating equipment located within 200 feet of residences may also be required. Water tanks and equipment storage, staging, and warm-up areas shall be located as far from noise-sensitive receptors as possible. The construction noise mitigation plan shall be prepared and implemented to the satisfaction of the City Planning Director.

GENERAL CONDITIONS

17. Site development, including landscaping, shall conform to the approved plans on file in the Director of Development Services. At least one set of approved plans containing Planning, Building, Fire, and, if applicable, Redevelopment and Health Department stamps shall be maintained at the job site, at all times for reference purposes during construction and final inspection.
18. The Director of Development Services is authorized to approve minor modifications to the approved design plans or to any of the conditions of approval if such modifications shall not significantly change/alter the approved design/project and if no detrimental effects to neighboring properties are caused by said modifications. Any major modifications shall be reviewed by the Zoning Administrator or Planning Commission, respectively
19. Prior to the issuance of a building permit, the applicant must depict all utility apparatus, such as, but not limited to, backflow devices and Edison transformers, on both the site plan and the landscape plan. These devices shall not be located in any front, side, or rear yard area that is adjacent to a public street. Furthermore, this equipment shall be properly screened by landscaping or any other screening method approved by the Director of Development Services.
20. Prior to the issuance of a building permit, the applicant must submit complete landscape and irrigation plans for the discretionary approval of the Director of Development Services. The landscaping plan shall include drought tolerant street trees to be installed consistent with the specifications of the Street Tree Division of the Department of Public Works. Approved root guards shall be provided for all street trees.
21. Where feasible, all landscaped areas shall be planted with drought tolerant plant materials. All landscaped areas shall be provided with water conserving automatic irrigation systems designed to provide complete and adequate coverage to sustain and promote healthy plant life. The irrigation system shall not cause water to spray or flow across a public sidewalk.

22. All landscaped areas must be maintained in a neat and healthy condition, including public parkways and street trees. Any dying or dead plant materials must be replaced with the minimum size and height plant(s) required by Chapter 21.42 (Landscaping) of the Zoning Regulations. At the discretion of city officials, a yearly inspection shall be conducted to verify that all irrigation systems are working properly and that the landscaping is in good healthy condition. The property owner shall reimburse the City for the inspection cost as per the special building inspection specifications established by City Council.
23. The property shall be developed and maintained in a neat, quiet, and orderly condition and operated in a manner so as not to be detrimental to adjacent properties and occupants. This shall encompass the maintenance of exterior facades of the building, designated parking areas serving the use, fences and the perimeter of the site (including all public parkways).
24. Exterior security bars and roll-up doors applied to windows and pedestrian building entrances shall be prohibited.
25. Any graffiti found on site must be removed within 24 hours of its appearance.
26. All parking areas serving the site shall provide appropriate security lighting with light and glare shields so as to avoid any light intrusion onto adjacent or abutting residential buildings or neighborhoods pursuant to Section 21.41.259. Other security measures may be required to be provided to the satisfaction of the Chief of Police.
27. All rooftop mechanical equipment shall be fully screened from public view. Said screening must be architecturally compatible with the building in terms of theme, materials, colors and textures. If the screening is not specifically designed into the building, a rooftop mechanical equipment plan must be submitted showing screening and must be approved by the Director of Development Services and Building prior to the issuance of a building permit.
28. Adequately sized trash enclosure(s) shall be designed and provided for this project as per Section 21.46.080 of the Long Beach Municipal Code. The designated trash area shall not abut a street or public walkway and shall be placed at an inconspicuous location on the lot.
29. All structures shall conform to the Long Beach Building Code requirements. Notwithstanding this subject permit, all other required permits from the Building Bureau must be secured. Please contact Ken Huang at 562-570-6423 for details.
30. Separate building permits are required for signs, fences, retaining walls, trash enclosures, flagpoles, pole-mounted yard lighting foundations and planters.
31. Approval of this development project is expressly conditioned upon payment (prior to building permit issuance or prior to Certificate of Occupancy, as specified in the applicable Ordinance or Resolution for the specific fee) of impact fees, connection fees and other similar fees based upon additional facilities

needed to accommodate new development at established City service level standards, including, but not limited to, sewer capacity charges, Park Fees and Transportation Impact Fees.

32. The applicant shall file a separate plan check submittal to the Long Beach Fire Department for their review and approval prior to the issuance of a building permit. Contact Sean Daugherty at 562-570-7087 for details.
33. The plans submitted for plan review must explicitly call out and describe all materials, textures, accents, colors, window, door, planter, and paving details that were approved by the Site Plan Review Committee and/or the Planning Commission. No substantial changes shall be made without prior written approval of the Site Plan Review Committee and/or the Planning Commission.
34. The Director of Development Services is authorized to make minor modifications to the approved preliminary plans or any of the conditions if such modifications shall achieve substantially the same results, as would strict compliance with said plans and conditions.
35. Grading and construction activities shall conform to Rule 403 of the South Coast Air Quality Management District and shall include the following:
 - a. Use water trucks and hoses to wet exposed and graded areas at least twice daily with complete coverage on all active areas and periodic wash-downs of public streets in the vicinity of all entrances and exits to the project site. Increase frequency of watering to three or more times per day whenever winds exceed 15 miles per hour, and cease grading activities during period of winds greater than 30 miles per hour.
 - b. Water material being excavated and stockpiled.
 - c. Water grading and cover materials being transported.
 - d. Maintain grading and construction equipment in proper tune.
 - e. Schedule truck trips to avoid peak hours (7-9 a.m. and 4-6 p.m., weekdays).
 - f. Discontinue construction during stage II smog alerts (ozone more than or equal to 0.35 ppm.)
 - g. Demolition, site preparation, and construction activities are limited to the following (except for the pouring of concrete which may occur as needed):
Weekdays and federal holidays: 7:00 a.m. to 7:00 p.m.;
Saturday: 9:00 a.m. - 6:00 p.m.; and
Sundays: not allowed
36. The applicant shall comply with the following conditions to the satisfaction of the Director of Public Works:
 - a. The Developer shall dedicate and improve 2 feet for street purposes along Indiana Avenue, adjacent to the project site. New concrete curb and gutter shall be reconstructed 4 feet westerly, resulting in a 10-foot wide walk, and a 34-foot wide roadbed. An additional 2 feet of roadbed shall be obtained when the property on the east side of the street is re-developed.
 - b. All obstructions, including power poles within the proposed street widening shall be relocated by the Developer at his expense, and to the satisfaction of the Director of Public Works.

- c. An installation and maintenance agreement is required for placement of planters and special paving within the public right-of-way. The Developer shall provide a plan to determine feasibility and for the approval of the Director of Public Works.
- d. The Developer shall construct all off-site improvements needed to provide full ADA accessibility compliance within the adjacent public right-of-way to the satisfaction of the Director of Public Works. If a dedication of additional right-of-way is necessary to satisfy ADA requirements, the right-of-way dedication shall be provided.
- e. The Developer shall be responsible for the maintenance of the off-site improvements during construction of the on-site improvements. All off-site improvements found damaged as a result of construction activities shall be reconstructed or replaced by the Developer to the satisfaction of the Director of Public Works.
- f. The Developer shall remove unused driveways and replace with full-height curb, curb gutter and sidewalk to the satisfaction of the Director of Public Works. Sidewalk improvements shall be constructed with Portland cement concrete. The size and configuration of all proposed driveways serving the project site shall be subject to review and approval of the City Traffic Engineer. Contact the Traffic and Transportation Bureau at (562) 570-6331 to request additional information regarding driveway construction requirements.
- g. The Developer shall remove and reconstruct the full-width of the alley adjacent to the project site with Portland cement concrete to the satisfaction of the Director of Public Works.
- h. The Developer shall provide for the resetting to grade of existing manholes, pullboxes, and meters in conjunction with the required off-site improvements to the satisfaction of the Director of Public Works.
- i. The Developer shall provide for tree wells, new street trees with root barriers and irrigation on Indiana Avenue, adjacent to the project site. The Developer and/or successors shall privately maintain all street trees, landscaping and sprinkler systems required in connection with this project.
- j. The Developer shall contact the Street Tree Division of the Department of Public Works, at (562) 570-2770, prior to beginning the tree planting, landscaping, and irrigation system work. The Street Tree Division will assist with the size, type and manner in which the street trees are to be installed.
- k. The Developer shall submit grading plan with hydrology and hydraulic calculations showing building elevations and drainage pattern and slopes for review and approval by the Director of Planning and Building Services and the Director of Public Works prior to approval of the map and/or release of any building permit.
- l. Prior to approving an engineering plan, all projects greater than 1 acre in size must demonstrate coverage under the State Construction General NPDES Permit. To meet this requirement, the applicant must submit a copy of the letter from the State Water Resource Control Board acknowledging receipt of the Notice of Intent (NOI) and a certification from the developer or engineer that a Storm Water Pollution Prevention Plan (SWPPP) has been prepared. Should you have any questions regarding the State Construction General NPDES Permit or wish to obtain an application, please call the State Regional Board Office at (213) 266-7500 or visit their website for complete instructions at www.waterboards.ca.gov/stormwtr/construction.html Left-click on the Construction General Permit 99-08-DWQ link.

- m. Public improvements shall be constructed in accordance with approved plans. Detailed off-site improvement plans shall be submitted to the Department of Public Works for review and approval.
 - n. The Developer shall replace all traffic signs and mounting poles damaged or misplaced as result of construction activities to the satisfaction of the City Traffic Engineer.
 - o. The Developer shall repaint all traffic markings obliterated or defaced by construction activities to the satisfaction of the City Traffic Engineer.
 - p. All traffic control device installations, including pavement markings within the private parking lot, shall be installed in accordance with the provisions of the Manual On Uniform Traffic Control Devices (MUTCD), 2003 edition (i.e., white parking stalls, stop signs, entry treatment signage, handicapped signage, etc.).
 - q. The Developer shall contact the Traffic & Transportation Bureau, at (562) 570-6331, to modify the existing curb marking zones, adjacent to the site.
37. Prior to issuance of a building permit, the applicant shall submit a lighting and security plan to the satisfaction of the Police Department. Please contact David Marander at (562) 570-5771 for assistance. Please see TAC comments.
38. Prior to issuance of a building permit, please contact Mike Zukoski at (562) 570-2038 for information on gas meter location requirements.
39. Please contact Larry Oaks of the Water Department for sewer and water line information at (562) 570-2382. See TAC comments.
40. The applicant shall defend, indemnify, and hold harmless the City of Long Beach, its agents, officers, and employees from any claim, action, or proceeding against the City of Long Beach or its agents, officers, or employees brought to attack, set aside, void, or annul an approval of the City of Long Beach, its advisory agencies, commissions, or legislative body concerning this project. The City of Long Beach will promptly notify the applicant of any such claim, action, or proceeding against the City of Long Beach and will cooperate fully in the defense. If the City of Long Beach fails to promptly notify the applicant of any such claim, action or proceeding or fails to cooperate fully in the defense, the applicant shall not, thereafter, be responsible to defend, indemnify, or hold harmless the City of Long Beach.

Findings

Application No. 0812-13

Date: February 4, 2010

GENERAL PLAN AMENDMENT

- A. **The proposed amendment conforms to the population, housing, design/architecture, and neighborhood preservation/enhancement goals of the General Plan, as detailed in the Land Use Element and other elements of the General Plan.**

Palm Desert Development Company is proposing to develop a three-story, 61-unit affordable senior apartment building at 3290 Artesia Blvd, at the southwest corner of Artesia Blvd and Indiana Avenue. The Project will provide high quality, comfortable accommodations for Long Beach's senior citizens and will incorporate substantial open space and generous amenities for residents. Building amenities include a large central courtyard that includes a pool, spa, fire pit and picnic area. Recreation rooms are found on the first floor of the structure and include an exercise room, a Yoga room, community rooms and classrooms.

The site is currently zone CCA and is located within the General Plan's Land Use District No.8N (Shopping Nodes). The applicant is requesting a change in the underlying zoning to CCN, to allow for an increase in height and residential dwelling units. The proposal also requires a change in the General Plan from LUD 8N to LUD 4 to allow consistency with the proposed CCN zoning designation. To allow for a more consistent land use pattern, an additional property located at 3232 Artesia Blvd is included in the zone change. The inclusion of that property will allow for a change of zone on the entire block.

LUD No.4 reflects the land use patterns and trends in the vicinity of the site, and therefore furthers the purpose, intent and provisions of the General Plan.

The requested General Plan Amendment advances the following goals, objectives and policies with respect to population, housing, design and architecture, and preservation and enhancement of neighborhoods:

Housing Element Population and Housing Goals and Objectives

- Goal #2: Provide increased opportunities for the construction of high quality new housing.
- Policy 2.1 Provide adequate sites, zoned at the appropriate densities, to facilitate the housing production and affordability goals set forth in the 1998-2005 Regional Housing Needs Assessment.
- Goal #4: Address the unique housing needs and circumstances of special needs populations.
- Policy 4.2 Integrate and disperse special housing within the community and in close proximity to transit and public services.
- Policy 4.6 Proactively seek out new models and approaches in the provision of affordable housing.

The proposed project will provide much needed affordable senior housing units, in direct support of the goals and policies of the Housing Element of the General Plan. The

project will allow the city to move closer to meeting its required RHNA goals in conformance with Policy 2.1. In addition, the project will help serve a needy population of lower-income seniors, in conformance with Policy 4.6. The project will also implement Policy 4.3 by being situated in close proximity to public transit lines along Artesia Boulevard. Approval of the General Plan Amendment would substantially conform to the purposes, intent and provisions of the General Plan.

Design, Architecture and Neighborhood Preservation/Enhancement Goals and Policies

Housing Element

Goal #2: Provide increased opportunities for the construction of high quality new housing.

Policy 2.3 Encourage new high quality rental and ownership housing through the implementation of design review guidelines and architectural standards.

Land Use Element

Goal: All residential projects [must] make a positive contribution to the neighborhood in which they are to be located, and provide a comfortable and salutary lifestyle for their occupants.

The proposed amendments to the General Plan will allow for the rezoning of one 1.48 acre parcel and the westerly 1.87-acre parcel to the requested CCN zone, thereby allowing for the change of the entire block and the construction of a 61-unit affordable senior apartment building on the 1.48-acre parcel. The proposed three story building will be articulated with architectural variations along both street frontages to softened the height of the building and reduce the mass, thus allowing the building to blend with adjacent one and two story buildings. Only a zone change will occur on the westerly 1.87-acre site.

The project as proposed will provide parking in excess of City requirements in a single on grade garage. Eighty-nine spaces will be provided onsite, whereby at least one space will be provided in a secured garage for each of the 61 units. An additional 17 spaces will be provided for guests and nearby residents. There will be minimal impacts to surrounding intersections or to on-street parking. This is justified by a traffic report, which shows low trip generation estimates for the proposed apartment complex.

The proposed project and amendments to the general plan satisfies the goal of the Land Use Element and thus, would substantially conform to the purposes, intent and provisions of the General Plan.

ZONE CHANGE FINDINGS

A. The proposed change will not adversely affect the character, livability or appropriate development of the surrounding area; and

The proposed change will not adversely affect the character, livability or appropriate development of the surrounding area. The project site is located on the corner of Artesia Blvd and Indiana Avenue on a 1.48 acre piece of property that contains a bank and parking lot. Many of the nearby commercial and residential properties are two stories in height. The proposed three-story building will be built according to CCN zoning regulations and although taller than most building in the area, the height is appropriate at

the proposed location. Staff believes that the projects building design and location will allow the building to blend well with adjacent two story commercial buildings on a major commercial corridor. Furthermore, the high quality materials used, will aesthetically improve the area.

B. The proposed project is consistent with the goals, objectives and provisions of the General Plan.

The proposed project advances the following goals, objectives and policies with respect to population, housing, design and architecture, and preservation and enhancement of neighborhoods:

Housing Element Population and Housing Goals and Objectives

- Goal #2: Provide increased opportunities for the construction of high quality new housing.
- Policy 2.1 Provide adequate sites, zoned at the appropriate densities, to facilitate the housing production and affordability goals set forth in the 1998-2005 Regional Housing Needs Assessment.
- Goal #4: Address the unique housing needs and circumstances of special needs populations.
- Policy 4.2 Integrate and disperse special needs housing within the community and in close proximity to transit and public services.
- Policy 4.6 Proactively seek out new models and approaches in the provision of affordable housing.

Design, Architecture and Neighborhood Preservation/Enhancement Goals and Policies

Housing Element

- Goal #2: Provide increased opportunities for the construction of high quality new housing.
- Policy 2.3 Encourage new high quality rental and ownership housing through the implementation of design review guidelines and architectural standards.

Land Use Element

- Goal: All residential projects [must] make a positive contribution to the neighborhood in which they are to be located, and provide a comfortable and salutary lifestyle for their occupants.

As an affordable senior apartment building, the proposed project will help serve the city's population of lower-income seniors with the addition of rental housing units. The project is also located near a public transit line along Artesia Blvd, which satisfy the goals and objective of the housing element to be near public services. The project will further implement this goal by providing either a shared vehicle program or zip car to all seniors in the building. Once developed, the project will provide high quality, comfortable accommodations for Long Beach's senior citizens and contribute to the neighborhood by offering an aesthetically pleasing design that blends well with existing residential and commercial uses in the vicinity, which is in direct support of the goals and objectives of the General Plan.

SITE PLAN REVIEW FINDINGS

- A. The design is harmonious, consistent and complete within itself and is compatible in design, character and scale, with neighboring structures and the community in which it is located;**

The proposed project is located near single-family homes, commercial offices, and a recreational park. The applicant proposal to add a three-story, 61 unit affordable senior apartment complex will provide much needed senior affordable apartments, to a community that is lacking such facilities. The proposed building is located along a major commercial corridor, setback sufficiently from the street, and designed with varying articulation on both street frontages that substantially reduce the mass of the building, thereby allowing the building to be more compatible in scale with neighboring structures. The varying articulation, in conjunction with the use of high quality materials is expected to aesthetically improve the surrounding neighborhood, thus allowing for a design that is harmonious, consistent and complete.

- B. The design conforms to any applicable special design guidelines adopted by the planning commission or specific plan requirements, such as the design guidelines for R 3 and R 4 multi-family development, the downtown design guidelines, PD guidelines or the general plan;**

The proposed project is designed to conform to the residential development standards of the R-4-N zoning district, according to the provision of the CCN zone. There are no additional special design guidelines, besides the following standards:

- 1. Architectural Themes. Architectural themes, modules and materials present on the main facade of the building shall be used on all other facades.**

All materials proposed on the main façade are wrapped around all sides of the building, even at the public alley.

- 2. Change of Material. Each side of a building must contain a primary and an accent material, and the accent material(s) must cover not less than ten percent (10%) of the facade.**

All facades contain brick veneer, wood, and smooth stucco. At least 10% of the façade contains a secondary wood or stucco material.

- 3. Building Finished Grade. All new commercial buildings requiring site plan review shall have the first habitable floor level not more than four feet (4') above grade within the front thirty feet (30') of the lot.**

The size of the lot does not allow for the placement of four feet of habitable space within the first 30-feet of the lot due to the need for resident and guest parking in the at-grade garage. Although a semi subterranean garage could have allowed the applicant to meet this requirement, it simply was not financial feasible and would have led to a smaller project. Staff recommends that the Planning Commission waive this finding so that much needed affordable housing can be added in North Long Beach.

- 4. Special Development Standards for CNP, CNA And CNR Districts. All new and remodeled commercial buildings in the Neighborhood Commercial zoning districts shall comply with the following design standards. Alternative designs may be approved through Site Plan Review. Site Plan Review is required for exterior remodeling of fifty feet (50') or more of building frontage.**

There are no additional special development standards in the CCN zone, besides those mentioned above.

- C. The design will not remove significant mature trees or street trees, unless no alternative design is possible;**

The development of the project will necessitate the removal of existing trees on the Site. However, none are significant. All mature trees removed from the site during demolition of the site will be replaced with mature canopy trees. The new landscaping will ultimately enhance the appearance of the site and the surrounding neighborhood.

- D. There is an essential nexus between the public improvement requirements established by this ordinance and the likely impacts of the proposed development; and**

There is one right of way dedication required. This is substantiated due to the inadequate width of the right-of-way. A proposed dedication of 2-feet on Indiana Avenue will assist in improving on-street parking and traffic movements onto Artesia Blvd. All public improvements are related to the project.

- E. The project conforms with all requirements set forth in chapter 21.64 (transportation demand management), which requirements are summarized in table 25 1 as follows:**

The project will only contain residential floor area; this requirement does not apply.

CONDITIONAL USE FINDINGS

- A. The approval is consistent with and carries out the General Plan, any applicable specific plans such as the local coastal program and all zoning regulations of the applicable district;**

The proposed project advances the goals, objectives and provisions of the General Plan by providing affordable senior housing in a desirable location. The proposal will be consistent with the applicable zoning regulations after the requested zone change. The project is not within any specific plan or coastal areas.

- B. The proposed use will not be detrimental to the surrounding community including public health, safety or general welfare, environmental quality or quality of life; and**

The proposed project will provide much needed affordable senior housing for elderly residents without causing any detriment to the surrounding community. Environmental issues have been thoroughly evaluated in the project's Mitigated Negative Declaration. Also a traffic study and historic assessment show no significant impacts associated with the project.

C. The approval is in compliance with the special conditions for specific conditional uses, as listed in Chapter 21.52

The following conditions shall apply to housing for active senior citizens:

1. Density shall be limited to that of the R-4-N Zoning District at the applicable lot width.

With a proposed change of zone from CCA to CCN, the applicant is limited to an R-4-N density. The maximum density allowed at the project site is 1 unit per 975 sq. ft. of gross floor area or 66 units. Since the applicant is providing less than the maximum density, they are in compliance with the condition.

2. The parking shall be provided as designated in Table 41-1A.

The project as proposed will provide parking in excess of City requirements in a single on grade parking garage. Eighty- nine spaces will be provided onsite, whereby at least one space will be provided in a secured garage for each of the 61 one units.

3. The use shall not abut or adjoin an automobile service or repair use.

The proposed use does not abut or adjoin an automobile service station or repair use. The use is adjacent to a park, convalescent hospital and auto rental business.

4. The use shall comply with all applicable development standards of the R-4-N Zone except for height and setbacks which shall comply with the standards of the district in which the use is located.

The project is designed to meet all applicable development standards for both the CCN and R-4-N zoning districts.

1
2
3
4
5
6
7
8
9
10
11
12
13
14
15
16
17
18
19
20
21
22
23
24
25
26
27
28

RESOLUTION NO.

A RESOLUTION OF THE CITY COUNCIL OF THE
CITY OF LONG BEACH ADOPTING, AFTER PUBLIC
HEARING, AMENDMENTS TO THE LAND USE ELEMENT
OF THE GENERAL PLAN OF THE CITY OF LONG BEACH

The City Council of the City of Long Beach resolves as follows:

Section 1. The City Council does hereby find, determine and declare:

A. The City Council of the City of Long Beach has adopted, pursuant to Section 65302 of the California Government Code, a Land Use Element as part of the City's General Plan.

B. The City Council desires to amend the Land Use Element of the General Plan of the City of Long Beach as set forth in this resolution.

C. The Planning Commission held a public hearing on February 4, 2010, on an amendment to the Land Use Element of the General Plan of the City of Long Beach.

D. At that hearing, the Planning Commission gave full consideration to all pertinent facts, information, proposals, environmental documentation and recommendations respecting all parts of the amendments to the General Plan of the City of Long Beach as to the amendments to the map of the Land Use Element and to the views expressed at the public hearing, and afforded full opportunity for public input and participation.

E. A Mitigated Negative Declaration was prepared in accordance with the Guidelines for Implementation of the California Environmental

1 Quality Act (CEQA) that there is no substantial evidence that the project will
2 have a significant effect on the environment.

3 F. Following receipt of all appropriate environmental
4 documentation, full hearings and deliberation, the City Planning
5 Commission recommended approval of the amendments to the Land Use
6 Element of the City of Long Beach General Plan and further directed that
7 said recommendation be forwarded to the City Council for consideration.

8 G. That on _____, 2010, the City Council
9 conducted a duly noticed public hearing at which it gave full consideration
10 to all pertinent facts, information, proposals, environmental documentation
11 and recommendations respecting all parts of the amendments to the Land
12 Use Element of the General Plan and the views expressed at the public
13 hearing and afforded full opportunity for public input and participation.

14 H. Following receipt of all appropriate environmental
15 documentation, full hearings and deliberation, the City Council did concur
16 with the recommendations of the Planning Commission and did approve
17 and adopt the environmental documentation and the amendment to the
18 Land Use Element of the General Plan from LUD 8N (Shopping Nodes) to
19 LUD 4 (High Density Residential) uses for those certain properties as
20 indicated on Exhibit "A", which is attached hereto and incorporated herein
21 by this reference.

22
23 Section 2. The City Council of the City of Long Beach hereby formally
24 approves and adopts the amendment to the map of the Land Use Element of the General
25 Plan of the City of Long Beach relating to those certain properties located in the City of
26 Long Beach, as certified and recommended by the Planning Commission of the City of
27 Long Beach as depicted in Exhibit "A", which is attached hereto and incorporated herein
28 by this reference.

1 Section 3. This resolution shall take effect immediately upon its adoption
2 by the City Council, and the City Clerk shall certify the vote adopting this resolution.

3 I hereby certify that the foregoing resolution was adopted by the City
4 Council of the City of Long Beach at its meeting of _____, 2010, by the
5 following vote:

6 Ayes: Councilmembers: _____

7 _____

8 _____

9 _____

10 Noes: Councilmembers: _____

11 _____

12 _____

13 Absent: Councilmembers: _____

14 _____

15 _____

16 _____

City Clerk

OFFICE OF THE CITY ATTORNEY
ROBERT E. SHANNON, City Attorney
333 West Ocean Boulevard, 11th Floor
Long Beach, CA 90802-4664

17
18
19
20
21
22
23
24
25
26
27
28

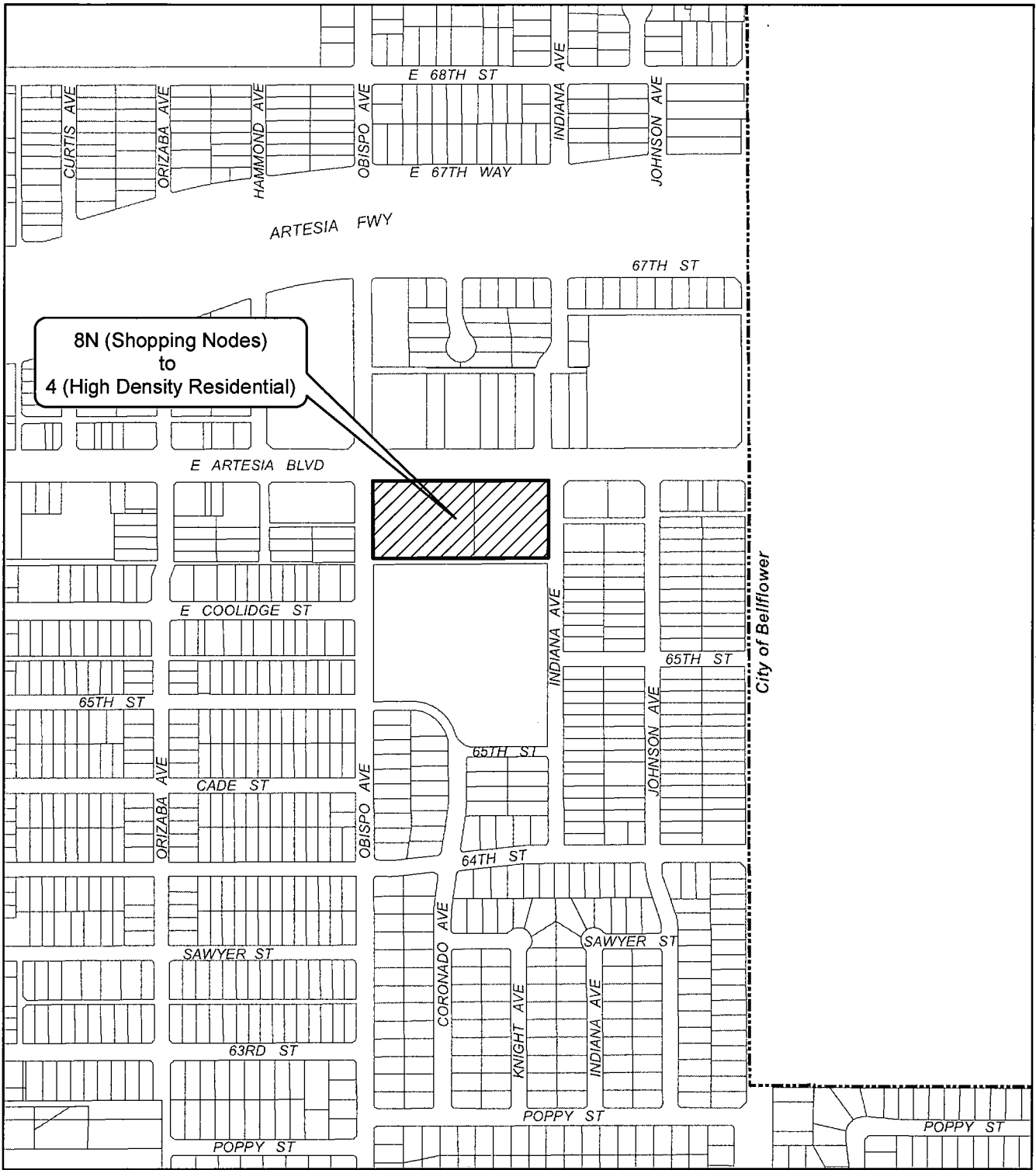

8N (Shopping Nodes)
to
4 (High Density Residential)

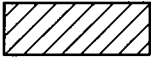

Area to be modified from LUD # 8N to LUD # 4

PROPOSED

**AMENDMENT TO A PORTION OF PART 30
OF THE LANDUSE DISTRICT MAP**



GPA Case
GP : 0812-13