

TABLE OF CONTENTS

AFFIDAVIT 3

I. BASIC LEASE PROVISIONS 4

 A.1. Shopping Center 4

 A.2. Premises 4

 A.3. Tenant's Trade Name 4

 A.4. Permitted Use 4

 A.5. Term 4

 A.6. Rent Commencement Date 4

 A.7. Expiration Date 4

 A.8. Minimum Rent 4

 A.9. Percentage Rent 5

 A.10. Estimated Delivery of Possession Date 5

 A.11. Outside Opening Date 5

 A.12. Common Area Charge 5

 A.13. Insurance Charge 5

 A.14. Real Estate Tax Charge 5

 A.15. Merchant's Association Dues 6

 A.16. Security Deposit 6

 A.17. Option to Renew 6

 A.18. Landlord's Address for Notices 6

 A.19. Tenant's Address for Notices 6

 A.20. Guarantor 6

 A.21. Broker 6

 A.22. Tenant Improvement Allowance 6

 A.23. Exhibits to Lease 6

II. PREMISES 7

III. TERM 7

IV. RENT 7

 A. Minimum Rent 7

 B. Percentage Rent 8

V. TAXES 8

 A. Real Estate Taxes and Assessments 8

 B. Rental Taxes 8

 C. Impact Fees 9

 D. Other Taxes For Which Tenant is Responsible 9

VI. CONSTRUCTION 9

 A. Landlord's Work 9

 B. Delivery of Premises 9

 C. Tenant's Construction 9

 D. Miscellaneous 10

VII. COMMON AREAS 11

 A. Common Areas 11

 B. Common Area Charge 11

 C. Reserve Account 12

VIII. UTILITIES AND RUBBISH DISPOSAL 12

 A. Utility Charges 12

 B. Rubbish Disposal 13

IX. USE OF PREMISES BY TENANT 14

 A. Tenant's Use of Premises 14

 B. Operation of Business 14

X. TENANT'S COVENANTS WITH RESPECT TO OCCUPANCY 14

XI. REPAIRS AND ALTERATIONS 17

 A. Repairs by Landlord 17

 B. Repairs by Tenant 18

 C. Alterations or Improvements by Tenant 18

 D. Removal of Improvements 18

XII. INDEMNITY AND INSURANCE 19

 A. Indemnification by Tenant 19

 B. Commercial General Liability Insurance 19

 C. Landlord's Liability 19

D.	Special Form Coverage Insurance	20
E.	Mutual Waiver of Subrogation	20
F.	Insurance Charge	21
G.	Workers Compensation	21
H.	Self Insurance	21
XIII.	DAMAGE AND DESTRUCTION	21
XIV.	ASSIGNING AND SUBLETTING	22
XV.	EMINENT DOMAIN	22
XVI.	DEFAULT BY TENANT	23
XVII.	NOTICES	25
XVIII.	SECURITY DEPOSIT	25
XIX.	MORTGAGE SUBORDINATION	25
XX.	ESTOPPEL CERTIFICATES	25
XXI.	QUIET ENJOYMENT	26
XXII.	LIABILITY OF LANDLORD	26
XXIII.	MISCELLANEOUS PROVISIONS	26
A.	Accord and Satisfaction	26
B.	Waiver	27
C.	Broker's Commission	27
D.	No Partnership	27
E.	Lease Inures to Benefit of Assignees	27
F.	Entire Agreement	27
G.	Abandonment, Surrender and Holding Over	27
H.	No Option	28
I.	Additional Rent	28
J.	Power of Attorney	28
K.	Financial Statements	28
L.	Severability	28
M.	Option to Renew	28
N.	Net Rent	28
O.	Counterparts	28
P.	Consents	28
Q.	Force Majeure	29
R.	Joint and Several Liability	29
S.	Right to Relocate	29
T.	Payment Under Protest	29
U.	Waiver of Trial By Jury	29
V.	Development of Shopping Center	30
W.	No Discrimination	30
X.	Attorneys Fees	30
Y.	Partial Invalidity	30
Z.	Miscellaneous	30
AA.	Parking	30
AB.	Rooftop Communication Equipment	31
	Schedule A. Rent Schedule	33
	Exhibit A-1. Legal Description	34
	Exhibit A-2. Site Plan for Shopping Center	36
	Exhibit B. Outline of Premises	37
	Exhibit C. Construction of Premises Provision	38
	Exhibit D. Tenant Design Criteria	provided separately
	Exhibit E. Exclusive and Prohibited Uses	56
	Exhibit G. Form of Subordination, Non-Disturbance and Attornment Agreement	60
	Exhibit H. Form of Memorandum of Lease Dates	66
	Exhibit I. Form of Sublease	67

29995 LEASE

THIS LEASE ("Lease"), is entered into as of this 21st day of March, 2007 (the "Effective Date") by and between **City Place Long Beach, LLC, City Place Long Beach TIC I, LLC, and City Place Long Beach TIC 2, LLC**, all Delaware limited liability companies, as tenants in common ("Landlord"), and the **City of Long Beach**, a municipal corporation ("Tenant").

WITNESSETH:

IN CONSIDERATION of the mutual covenants hereinafter contained, and each act performed hereunder by either of the parties, Landlord and Tenant agree as follows:

I. BASIC LEASE PROVISIONS

- A. This Article I is an integral part of this Lease and all of the terms hereof are incorporated into this Lease in all respects. In addition to the other provisions which are elsewhere defined in this Lease, the following, whenever used in this Lease shall have the meanings set forth in this Article I:
1. **Shopping Center:** The retail development described on Exhibit A-1 and depicted on Exhibit A-2 attached to this Lease, constituting a portion of the City Place project in Long Beach, California (Article II).
 2. **Premises:** Unit No. J-115 containing 3,179 square feet of gross leasable area, as depicted on Exhibit B attached to this Lease (Article II).
Street address: 540 Pine Avenue, Long Beach, CA 90802
 3. **Tenant's Trade Name:** None.
 4. **Permitted Use:** General office use related to certain veterans' organizations, including use on an occasional basis as a community meeting center and, when applicable, as a polling place in accordance with Article IX, but in all cases subject to the restrictions in Exhibit E.
 5. **Term:** Five (5) lease years, commencing on the Rent Commencement Date and expiring on the Expiration Date (Article III).
 6. **Rent Commencement Date:** The date which is ninety (90) days following Delivery of Premises (Article III).
 7. **Expiration Date:** The day preceding the fifth (5th) anniversary of the Rent Commencement Date, except that if the Rent Commencement Date does not occur on the first day of a calendar month, then the Expiration Date shall be the last day of the calendar month in which the fifth (5th) anniversary of the Rent Commencement Date occurs (Article III).
 8. **Minimum Rent:** See Rent Schedule attached as Schedule A to this Lease (Article IV). Rent should be made payable to TEC Property Management Inc.

9. **Percentage Rent:** None (Article IV).
10. **Estimated Delivery of Possession Date:** No later than five (5) business days following the full execution and delivery of this Lease (Article VI).
11. **Outside Opening Date:** One hundred eighty (180) days following the Delivery of Possession Date (Article VI).
12. **Common Area Charge:** The product of (i) Tenant's Proportionate Share, multiplied by (ii) the total Common Area Costs less the portion of Common Area Costs paid by Major Tenants (Article VII).

12.1 Tenant's Proportionate Share: The quotient obtained by dividing (i) the gross leasable area of the Premises, by (ii) the then current gross leasable area of all tenant spaces existing in the Shopping Center at the time of the calculation, excluding from clause (ii) the gross leasable area of space leased to or occupied by Major Tenants, and excluding from clause (ii) with respect to any individual item the gross leasable area of any tenant space with respect to which the tenant directly pays the subject expense or directly provides the subject service at its own cost.

12.2 Initial Estimate of Common Area Charge: \$5.00 per square foot of the gross leasable area of the Premises per year.

12.2(a) Cap on Common Area Charge: Including the Reserve Account Charge, the Insurance Charge and the Real Estate Tax Charge, Tenant's obligation for common area costs shall not exceed \$9.00 per square foot per year in the calendar year 2007 . In the following calendar year and each subsequent calendar year including the Option Terms, Tenant's obligation for Common Area Charges (excluding real estate taxes and insurance) shall not increase by more than five (5) per cent per year on a cumulative basis.

12.3 Reserve Account Charge: \$0.10 per square foot of the gross leasable area of the Premises per year.

13. **Insurance Charge:** The product of (i) Tenant's Proportionate Share (the quotient obtained by dividing (a) the gross leasable area of the Premises, by (b) the then current gross leasable area of all tenant spaces existing in the Shopping Center at the time of the calculation, excluding from clause (b) the gross leasable area of space leased to or occupied by Major Tenants), multiplied by (ii) the costs and expenses incurred by Landlord for insurance procured by Landlord respecting the Shopping Center and its operations, as more fully described in Article XII, Sections B, D and F of the Lease, less the total contribution to such insurance expenses made by Major Tenants (Article XII).

13.1 Initial Estimate of Insurance Charge: \$1.20 per square foot of the gross leasable area of the Premises per year.

14. **Real Estate Tax Charge:** The product of (i) Tenant's Proportionate Share, (the quotient obtained by dividing (a) the gross leasable area of the Premises, by (b) the then current gross leasable area of all tenant spaces existing in the Shopping Center at the time of the calculation, excluding from clause (b) the gross leasable area of space leased to or occupied

by Major Tenants), multiplied by (ii) the total Taxes incurred by Landlord in accordance with Article V less the total contribution to Taxes made by Major Tenants (Article V).

14.1 Initial Estimate of Real Estate Tax Charge: \$2.70 per square foot of gross leasable area of Premises per year.

15. Merchants Associations Dues/Promotional Fund Contribution: None.

16. Security Deposit: Zero (\$0) dollars (Article XVIII).

17. Options to Renew: See Rent Schedule A (Article XXIII, Section M).
Three (3) consecutive period(s) containing two (2) lease years each ("Renewal Term"); no less than 180 days and no more than 270 days prior notice to exercise required.

18. Landlord's Address for Notices:

City Place Long Beach, LLC; City Place Long Beach TIC I, LLC; and City Place Long Beach TIC 2, LLC
c/o TEC Property Management Inc.
Attention: Tony Shooshani
9200 W. Sunset Boulevard, Penthouse 9
West Hollywood, CA 90069
Federal I. D. # [REDACTED]

19. Tenant's Address for Notices:

City of Long Beach
333 W. Ocean Blvd., 13th Floor, Attention: City Manager
Long Beach, CA 90802
Federal I.D. # [REDACTED]

With a copy to:

City of Long Beach
333 W. Ocean Blvd., 3rd Floor,
Attention: Property Services Bureau Manager
Long Beach, CA 90802

Or at Landlord's election after Tenant takes occupancy of the Premises, at the address of the Premises.

20. Guarantor(s): None

21. Broker(s): Landlord: **Wilson Commercial Real Estate**
Tenant: **Cushman & Wakefield of California, Inc.**

22. Tenant Improvement Allowance: Thirty two thousand (\$32,000) Dollars or Ten Dollars and seven cents (\$10.07) per square foot. (Exhibit C).

23. Exhibits to Lease

Schedule A: Rent Schedule

- Exhibit A-1: Shopping Center Legal Description
- Exhibit A-2: Shopping Center Site Plan
- Exhibit B: Outline of Premises
- Exhibit C: Construction of Premises Provisions
- Exhibit D: Tenant Signage Criteria
- Exhibit E: Exclusive and Prohibited Uses at City Place, Long Beach, CA
- Exhibit F: Lease Guaranty - Omitted
- Exhibit G: Form of Subordination, Non-Disturbance and Attornment Agreement
- Exhibit H: Form of Memorandum of Lease Date Terms
- Exhibit I: Form of Sublease Agreement

II. PREMISES

- A. Landlord leases to Tenant, and Tenant leases from Landlord, the premises described in Article I (A), Section 2 ("Premises") and outlined on Exhibit B. For purposes of this Lease, "gross leasable area" of a subject space shall mean the square foot area of such space as measured from the exterior face of any exterior walls of the subject space, except that any common wall shared with another tenant space shall be measured to the centerline of such common wall. The Shopping Center is more particularly described on Exhibit "A-1" attached hereto and depicted on the Site Plan attached hereto as Exhibit A-2. The Shopping Center shall not include any property referenced as excluded from the Shopping Center on Exhibit A-2. Landlord shall have the right to make changes or modifications to the Shopping Center definition and Site Plan from time to time.
- B. Landlord reserves the right to maintain, repair, and replace utility lines under, over, upon or through the Premises as may be reasonably necessary or advisable for the servicing of the Premises or other portions of the Shopping Center.

III. TERM

- A. The Term of this Lease shall commence upon the Rent Commencement Date set forth in Article I (A) Section 6 and shall expire on the last day of the last consecutive full lease year set forth in Article I (A), Section 7, unless sooner terminated. The parties hereto shall execute a Memorandum of Lease Term Dates in substantially the form attached hereto as Exhibit "H" setting forth the actual Rent Commencement Date and Expiration Date of this Lease. The term "lease year" shall mean a period of twelve (12) consecutive full calendar months. The first lease year shall commence on the Rent Commencement Date and end on the day preceding the first anniversary of the Rent Commencement Date, provided that if the Rent Commencement Date does not occur on the first day of a calendar month, then the first lease year shall end on the last day of the calendar month during which the first anniversary of the Rent Commencement Date occurs. The second and each successive lease year shall commence on the day following the end of the first lease year and each successive anniversary thereof. Notwithstanding that the Term of this Lease shall not commence until the Rent Commencement Date, all terms and conditions of this Lease shall be applicable on and after the Effective Date of this Lease, except that Tenant's obligation to pay Minimum Rent, Percentage Rent, Common Area Charge, Reserve Charge, Real Estate Tax Charge and Insurance Charge shall not commence until the Rent Commencement Date, unless expressly provided herein to the contrary.

IV. RENT

- A. **Minimum Rent.** Tenant agrees to pay to Landlord, at its office or other place as Landlord may from time to time designate, as "Minimum Rent" for the Premises during the term of this Lease, without any deduction or setoff, the amount(s) set forth in the Rent Schedule attached as Schedule

A to this Lease, in advance, on the first day of each calendar month. Minimum Rent and the amounts to be paid by Tenant pursuant to Articles V, VII, VIII, and XII hereof shall be prorated on a per diem basis (based upon a thirty (30) day calendar month) for any partial month included in the first lease year. **Within three (3) weeks of Tenant's and Landlord's execution of this Lease, Tenant shall pay to Landlord the full first month's Minimum Rent, Common Area Charge, Real Estate Tax Charge, Insurance Charge and Reserve Account Charge in the amount of Eight thousand seven hundred forty two dollars and twenty five cents (\$8,742.25).**

B. Percentage Rent. Omitted

V. TAXES

A. Real Estate Taxes and Assessments. Commencing on the Rent Commencement Date, Tenant agrees to pay the Real Estate Tax Charge set forth in Article I (A), Section 14 in accordance with the terms and provisions of this Article V. "Taxes" shall mean all taxes, fees, charges, impositions and/or assessments of every kind and nature, both general and special, levied and assessed against the land, buildings, and all other improvements which may be added thereto, or constructed on, in or about the Shopping Center. Taxes shall include, without limitation, (i) all taxes on Landlord's right to rent or business of leasing any of the Shopping Center, (ii) any personal property taxes imposed upon the fixtures, equipment, systems or other property used in connection with the operation of the Shopping Center, (iii) any assessment, tax, levy or charge in addition to, or in substitution, partially or totally of, any real estate tax, it being acknowledged by Tenant and Landlord that Proposition 13 was adopted by the voters of the State of California in the June 1978 election and that assessments, taxes, levies or other charges may be imposed by governmental agencies for such services as fire protection, street, sidewalk and road maintenance, refuse removal and for other governmental services formerly provided without charge to property owners or occupants, and that the intent of the parties is for any such new assessments, taxes, levies or other charges to be included in the definition of Taxes, and (iv) any costs or expenses incurred by Landlord in attempting to protest, reduce, minimize or prevent increases in Taxes. Taxes shall not include any income, estate gift, inheritance, excess profits or franchise taxes (except as provided in clauses (i) and (iii) above). As used herein, the term "Major Tenant" shall mean any individual tenant of the Shopping Center leasing or occupying more than 20,000 square feet of gross leasable area.

Tenant's proportionate share shall be the total amount of the Taxes, less the total contribution to Taxes made by Major Tenants multiplied by a fraction, the numerator of which shall be the number of square feet of gross leasable area within the Premises, and the denominator of which shall be the then gross leasable area of all tenant spaces existing in the Shopping Center at the time of the calculation, but excluding the gross leasable area of space leased to or occupied by Major Tenants.

Tenant shall pay to Landlord, monthly in advance on or before the first day of each calendar month, an amount equal to one-twelfth (1/12th) of Landlord's estimate of the Real Estate Tax Charge for the current tax year. Landlord's initial estimate of the Real Estate Tax Charge for the tax year is set forth in Article I (A), Section 14.1. Landlord shall have the right to adjust such estimate from time to time. If the Real Estate Tax Charge payable by Tenant with respect to any tax year is less than the total amount paid by Tenant for such period, the excess shall be credited against the payments with respect to Taxes next becoming due. If the Real Estate Tax Charge payable by Tenant for any tax year exceeds the total amount paid by Tenant for such period, Tenant shall pay the difference to Landlord upon demand.

B. Rental Taxes. If any governmental taxing authority shall levy, assess, or impose any tax, excise or assessment (other than income or franchise tax) upon or against the rents payable by Tenant to

Landlord ("Rent Tax"), either by way of substitution for or in addition to any existing tax on land, buildings or otherwise, Tenant shall directly pay, or reimburse Landlord for, the Rent Tax, as the case may be.

- C. **Impact Fees.** Tenant shall pay all impact fees, including, without limitation, any commercial impact fees for water and sewer, attributable to Tenant's use of and/or square footage in the Premises. Tenant shall reimburse Landlord for any such fees previously paid by Landlord and attributable to the Premises.
- D. **Other Taxes For Which Tenant is Responsible.** In addition to the Real Estate Tax Charge, Tenant shall pay directly or also reimburse Landlord within thirty (30) days following written demand for (i) any taxes assessed or levied against Landlord attributable to the cost of value of Tenant's equipment, furniture, fixtures and other personal property located on or about the Premises or Shopping Center; (ii) any increase in Taxes attributable to a change by Tenant in its use of the Premises; and (iii) any taxes assessed upon this transaction or any document to which Tenant is a party that creates or transfers an interest or an estate in the Premises or Tenant's interest under this Lease.

VI. CONSTRUCTION

- A. **Landlord's Work.** The Premises shall be delivered by Landlord to Tenant in their current "As-Is" condition. Except for its obligation to enter into a contract for the performance of Tenant's Work, Landlord shall not be obligated to perform any work or improvements with regards to the Premises.
- B. **Delivery of Premises.** Landlord shall use reasonable efforts to deliver the Premises to Tenant on or before the Estimated Delivery of Possession Date set forth in Article I (A), Section 10, herein, in an "As Is" condition, subject to delays caused by acts of God, government or public enemy, labor disputes, inability to obtain material or labor on reasonable terms, or any other cause beyond Landlord's control. Under no circumstances shall Landlord be liable to Tenant for any failure or delay by Landlord in delivering the Premises to Tenant on the date set forth above. Landlord represents and warrants to Tenant that the HVAC, plumbing, sewer and electrical systems, to the extent the same currently exist in the Premises, are in good working order. Tenant hereby acknowledges that Landlord has made no other representations or warranties to Tenant with respect to the condition of the Premises or the working order of any other systems or improvements therein existing as of the date of delivery.
- C. **Tenant's Construction.** Within fifteen (15) days from the date of this Lease, Tenant shall prepare and deliver to Landlord detailed plans and specifications of the improvements to the Premises to be constructed by Tenant in compliance with Exhibit C attached hereto and made a part hereof. Within fifteen (15) days following Landlord's receipt of Tenant's plans and specifications Landlord shall notify Tenant whether Tenant's plans and specifications are acceptable to Landlord. If Tenant's plans and specifications are not acceptable to Landlord, Landlord will advise Tenant of the required modifications to Tenant's plans and specifications. Tenant shall modify and deliver to Landlord its revised plans and specifications within five (5) days from receipt of Landlord's required modifications. Landlord and Tenant will continue this process until Landlord has approved Tenant's plans and specifications ("Tenant's Work").

Within ten (10) days after approving Tenant's plans and specifications, Landlord shall enter into a written contract that complies with the requirements of this Lease and Exhibit C to perform Tenant's Work ("Tenant Work Contract") with a contractor selected by Tenant ("Tenant's Contractor"). Landlord shall not be responsible for reviewing the contractor bids, the terms of the Tenant Work Contract, particularly related to the scope of services or required payment amounts, oversight of any Tenant Improvements or project management. Tenant has selected Heery

International ("Tenant's Representative") to be its representative and to provide architectural and construction management services. Tenant's Representative's fees including costs for construction management services, construction drawings and any and all engineering and structural drawings for the construction of the Premises may be paid from the Allowance provided for and defined in Exhibit C. Landlord shall be obligated to pay Tenant's Contractor for work performed; provided, however, that Tenant shall reimburse Landlord for all Construction Items, costs and expenses incurred under such contract which exceed the Allowance at least three (3) business days prior to each payment required to be made by Landlord to Tenant's Contractor or Tenant's Representative ("Tenant Reimbursement Payments"). Tenant or Tenant's Representative shall provide Landlord with a complete payment package including lien releases prior to requiring Landlord to make a payment. All references herein to "Tenant's Contractor" shall mean the contractor which executed the construction contract with Landlord, it being the intention of the parties to this Lease that Landlord execute the construction contract but that Tenant act as Landlord's construction manager and agent under such contract and be responsible for all obligations of Landlord in any way related to such contract, construction or Tenant Reimbursement Payments. Tenant shall indemnify Landlord from all costs that may arise from the Tenant Work Contract including, but not limited to, any time, expense or penalty related to a Prevailing Wage Audit, any liens filed against the Shopping Center or the Premises or costs associated with removing said liens.

Within ten (10) days from receipt of Landlord's approval of Tenant's plans and specifications, Tenant will apply for any and all permits and other governmental approvals necessary to perform Tenant's work and Tenant will diligently prosecute such application until approved. Tenant shall not modify Tenant's plans and specifications approved by Landlord without Landlord's prior written consent.

Upon Tenant's receipt of Landlord's notice that the Premises are available for Tenant to commence Tenant's Work, and provided Landlord has approved Tenant's Final Plans pursuant to Exhibit C, Tenant shall commence construction of Tenant's Work in accordance with the approved Final Plans and Exhibit C attached to this Lease. Tenant shall complete construction of Tenant's Work and the installation of all improvements and fixtures necessary for the operation of Tenant's business, and initially open for business to the public on or before the Outside Opening Date provided in Section 11 of the Basic Lease Provisions. In no event shall the Outside Opening Date be extended as a result of Tenant's failure to deliver plans and specifications and any revisions thereto, file for permits or applications and/or to commence construction in accordance with the timetables set forth in this section or Exhibit C. Tenant shall not commence any work in the Premises until Tenant delivers to Landlord a policy of public liability and property damage insurance in accordance with the requirements of Article XII of this Lease.

D. Miscellaneous.

- (i) Tenant shall be required to control and retain noise, dust or other materials within the Premises, subject to directives from Landlord. Tenant shall be required to clean all H.V.A.C. filters clogged with dust, or other materials resulting from its construction activities.
- (ii) To the extent the cost of Tenant's Work shall exceed Twenty-five Thousand and 00/100 Dollars (\$25,000.00), Tenant's contractor shall furnish and maintain performance and payment bonds in an amount equal to one hundred twenty-five percent (125%) of the construction contract price and all additions thereto, and all obligations arising in connection therewith. The performance and payment bonds shall name Landlord as

obligees and will be in such a form and with such sureties as are reasonably satisfactory to Landlord.

VII. COMMON AREAS

- A. **Common Areas.** Landlord grants to Tenant and Tenant's customers and invitees the non-exclusive right to use the areas designated by Landlord from time to time as Common Areas. The term "Common Areas" shall mean the parking areas, roadways, pedestrian sidewalks, loading docks, delivery areas, exterior surfaces of Shopping Center buildings, landscaped areas, service courts, open and enclosed courts and malls, fire corridors, meeting areas and public restrooms, any areas for use or access provided by easement or agreement from contiguous parcel owners (including roof areas), and all other areas or improvements which may be provided by Landlord for the common use of the tenants of the Shopping Center. Landlord hereby reserves the following rights with respect to the Common Areas:
1. To establish reasonable rules and regulations for the use thereof;
 2. To use or permit the use by others to whom Landlord may have granted such rights for promotional activities;
 3. To close all or any portion thereof as may be deemed necessary by Landlord to prevent a dedication thereof or the accrual of any rights to any person or the public herein;
 4. To change the layout of such Common Areas, including the right to reasonably add to or subtract from their shape and size, whether by the addition of building improvements or otherwise, and shall have the right to retain revenue from income producing events whether or not conducted for promotional purposes; and
 5. To operate, manage, equip, light, repair and maintain said Common Areas for their intended purposes in such manner as Landlord shall in its sole discretion from time to time determine.
- B. **Common Area Charge.** Commencing on the Rent Commencement Date, Tenant shall pay to Landlord the "Common Area Charge" set forth in Article I (A), Section 12 of this Lease. For purposes of this Lease, "Common Area Costs" shall mean all costs and expenses of every kind and nature paid or incurred by Landlord in operating, maintaining, repairing and managing the Common Areas, including but not be limited to, cleaning, lighting, repairing, painting, maintaining, and replacing all Common Area improvements including the roofs of all buildings within the Shopping Center; snow removal, landscaping and security; fire safety and protection systems, monitoring, testing and operating charges; restriping and overlay of the parking lot; painting of exterior surfaces of Shopping Center buildings; total compensation and benefits (including premiums for Worker's Compensation and other insurance) paid to or on behalf of employees; personal property taxes; supplies; fire protection; utility charges; licenses and permit fees; reasonable depreciation of equipment used in operating and maintaining the Common Areas and rent paid for leasing such equipment, any fees paid or assessed by Landlord for management of the Shopping Center as are normally paid or assessed by other similar projects in the greater Los Angeles or Orange County areas; and administrative costs equal to fifteen percent (15%) of the total cost of all the other items included in Common Area Costs. If Landlord does not utilize the services of an unrelated third party property management company and manages the Shopping Center directly, then Common Area Costs shall include either the property management fees or the fifteen percent administrative costs. Common Area Costs shall also include any costs or expenses incurred by Landlord in connection with the use, operation, maintenance or repair of the public parking structures shown on Exhibit A, but not included in the Shopping Center. Common Area Costs shall also include any costs or expenses incurred by Landlord in connection

with the use, operation, maintenance or repair of the easement areas in the Residential buildings, shared or of exclusive use to the Shopping Center, or equipment contained therein, shown on Exhibit A, but not included in the Shopping Center. Notwithstanding anything to the contrary above, Common Area Costs shall NOT include (i) costs or charges for promotional advertising of the Premises, the Shopping Center, or any tenant thereof, (ii) costs for special services rendered to individual tenants for which a special charge is made; (iii) costs for which a tenant is obligated to reimburse Landlord due to particular responsibility of such tenant and not as part of such tenant's share of Common Area Costs; (iv) all costs associated with individual tenant spaces, e.g., improvements, inspection, performance of covenants, or charges for exclusive services.

1. Tenant's Common Area Charge shall be paid in monthly installments on the first day of each month in an amount to be estimated by Landlord. Landlord's initial estimate of the Common Area Charge is set forth in Article I (A), Section 12.2. Landlord shall have the right to adjust such estimate from time to time. Subsequent to the expiration of the period used by Landlord in estimating Landlord's Common Area Costs, Landlord shall furnish to Tenant a statement of the actual amount of Tenant's Common Area Charge for such period and within fifteen (15) days after receipt of such statement, Tenant shall pay to Landlord or Landlord shall remit to Tenant, as the case may be, the difference between the estimated amounts paid by Tenant and the actual amount of Tenant's Common Area Charge for such period as shown by such statement. At Landlord's option, Landlord may credit Tenant's overpayment to Common Area Charges next becoming due.

- C. **Reserve Account.** Commencing on the Rent Commencement Date, in addition to Tenant's contribution for Common Area Costs as provided at Article VII, Section B, above, Tenant shall also be required to pay to Landlord a Reserve Account Charge in an amount equal to the amount per square foot of gross leasable area of the Premises per year set forth in Article I (A), Section 12.3, above, representing Tenant's contribution to the Reserve Account for "major repairs" to or replacement of Common Area improvements performed by Landlord subsequent to the Rent Commencement Date. Tenant's Reserve Account Charge contribution shall be paid in equal monthly installments during the Term of this Lease or any renewals thereof, in advance, on or before the first day of each calendar month. The term "major repairs" shall include, but shall not be limited to major repairs of a capital nature to or replacement of parking lot surfaces, sidewalks, roofs and utility lines. Funds contributed by Tenant to the Reserve Account Charge shall not be applied to the items recited in Article VII, Section B, above, but shall be retained by Landlord until such time as Landlord shall perform a major repair, regardless of the date(s) such amount was contributed by Tenant. In no event shall Tenant have any interest in Reserve Account Charge payments or be entitled to a refund of the amounts so contributed by Tenant to the Reserve Account Charge. In no event shall Landlord profit from the Reserve Account Charge.

VIII. UTILITIES AND RUBBISH DISPOSAL

- A. **Utility Charges.** Commencing on the date Landlord delivers the Premises to Tenant, Tenant shall pay for all utilities provided to or for the benefit of the Premises, including but not limited to water/sewer, demand or reservation fees, gas, electricity, fuel, light, heat, power, telephone, cable, and trash and garbage removal, together with all taxes levied or other charges on such utilities and governmental charges based on utility consumption. Tenant shall, at its sole cost and expense, pay for the cost of installation of meters for the Premises and any and all related costs and expenses if such meters do not already exist at the Premises.

If any utilities are not separately metered or are only partly separately metered and are used in common with other tenants of the Shopping Center, Tenant shall pay to Landlord its prorata share

of such charges computed by multiplying such charges by the ratio of the square feet within the Premises to the square feet of all tenants using such common facilities.

Notwithstanding the foregoing, Landlord shall have the right, but not the obligation, to supply Tenant with any or all utility services provided to or for the benefit of the Premises and Tenant shall pay the cost of such utility service(s) to Landlord. In the event Landlord supplies any such utility service(s), Tenant shall reimburse Landlord within ten (10) days after the delivery by Landlord to Tenant of a statement for the cost of any such utility service(s) supplied by Landlord. In no event, however, shall the cost of such utility service(s) supplied by Landlord exceed a rate which Tenant would otherwise pay for such utility service(s) if Tenant obtained such utility service(s) directly from the applicable utility supplier (subject to the provisions of the next following paragraph). Landlord and Tenant further agree that Landlord shall have the right to discontinue supplying such utility service(s) upon ten (10) days prior written notice to Tenant, provided Landlord shall not discontinue such utility service(s) until Tenant has obtained the discontinued utility service(s) from the applicable utility supplier and Tenant has provided Landlord with written notice thereof.

Landlord and Tenant hereby acknowledge that electrical service to the Premises may be furnished by one or more companies providing electrical generation, transmission and/or distribution services. Landlord hereby reserves the right to charge Tenant for the cost of electrical service to the Premises as a single charge or divided into and billed in a variety of categories such as distribution charges, transmission charges, generation charges, public good charges or other similar categories. Landlord further reserves the right, at its sole discretion, to select the company(ies) providing electrical service(s) to the Shopping Center, including the Premises, to aggregate the electrical service for the Premises and other premises within the Shopping Center, to purchase electricity for the Shopping Center, including the Premises, through a broker and/or buyers group and to change the providers and/or manner of purchasing electricity from time to time, so long as such electrical service is offered at a commercially reasonable rate. Landlord shall be entitled to receive a reasonable fee (if permitted by law) for the services provided by Landlord in connection with the selection of utility companies and the negotiation and administration of contracts for the generation of electricity to the Shopping Center. In addition, if Landlord bills Tenant directly for the cost of electricity service to the Premises, the cost of electricity service may include (if permitted by law) an administrative fee to reimburse Landlord for the cost of reading meters, preparing invoices and related costs.

- B. **Rubbish Disposal.** Landlord reserves the right to implement a uniform program of rubbish removal which shall be applicable to all tenants in the Shopping Center, except for the right of Landlord to exclude from such program all or portions of the Major Tenants. Landlord shall implement such program by (i) the initial acquisition by purchase or lease of disposal facilities, including but not limited to, compactor(s), baling machine(s) and/or incinerator(s), and the cost of initial acquisition and installation of such equipment or facilities shall be reimbursable to Landlord within thirty (30) days from receipt of Landlord's invoice based upon a proration from each tenant according to the projected use of such facilities, (ii) the implementation of uniform and objective rules and regulations for the storage, separation and disposal of rubbish, and (iii) establishment of guidelines for the scheduled and permitted uses of any such facilities, alternate methods of disposing of any rubbish which is not compatible with the facility, and a schedule of costs and fees to each tenant for the use of said facilities (inclusive of the cost of any required maintenance of such facilities and the cost of removal of the by-product from the Shopping Center). Landlord, in its sole discretion, shall have the right to retain the services of an independent consultant or an independent operator, the cost of which shall be included in the total

cost of the program. Landlord reserves the right to utilize the facilities to dispose of Common Area rubbish and such cost, if any, shall be included in the Common Area charge.

Landlord shall not be liable for the quality, quantity, failure, or interruption of the foregoing utility and rubbish disposal services to the Premises unless such failure or interruption is caused specifically by an act or gross omission of Landlord.

IX. USE OF PREMISES BY TENANT

- A. **Tenant's Use of Premises.** Tenant shall use the Premises only for the uses set forth in Article I (A), Section 4, of this Lease and for no other purpose. Tenant and its approved subtenants may also use the Premises on an occasional basis as a community meeting center and, when applicable, as a polling place. In no way limiting the two preceding sentences, Tenant shall not use the Premises for any purpose described in Exhibit E.
- B. **Operation of Business.** Tenant agrees to open for business on or before the Outside Opening Date, fully fixtured and staffed and to conduct in 100% of the Premises, at least, in any event, from 10:00 A.M. to 7:00 P.M., on all business days (for purposes of this Lease "business days" shall mean Monday through Friday, excluding holidays) during the Term of this Lease and any renewal or extension thereof, the business described in Article I (A), Section 4, above, except where Tenant is prevented from doing so by strikes, casualty or other causes beyond Tenant's control. In consideration of the residents in the residential units above the Premises, in no event, however, will Tenant be open for business on any day after 10:00 P.M. or before 9:00 A.M. without Landlord's prior written consent. Due to parking constraints, in no event will Tenant have any community meetings from the period of Thanksgiving through New Years Day each year. Should Tenant anticipate that any community meetings will have more than fifty (50) people in attendance during any one hour period, then Tenant must notify Landlord in writing preferably one week but no less than three (3) days in advance of said community meeting along with a description of the activities to take place so that Landlord can reasonably determine if additional security or other operational personnel will be required. Tenant shall be responsible at its own expense for adequate security for community meetings.

Should Tenant's schedule require opening before 9:00A.M. or closing after 10:00 P.M. and should that early opening / late closing require additional service personnel (example being additional security or janitorial personnel, etc), then Tenant shall reimburse Landlord for the cost of the additional service required solely by Tenant's early opening / late closing. Should there be more than one tenant necessitating such additional services at that hour, then the cost would be shared between the tenants requiring such service on a pro-rata basis. Landlord reserves the right to adjust service to the common area based on the needs of the Shopping Center in its sole discretion.

Tenant shall not permit loud music or bands in or around the Premises. Tenant shall be subject to the use restrictions in the CC&R's with the residential ownership above the Premises and any future changes to the CC&R's.

X. TENANT'S COVENANTS WITH RESPECT TO OCCUPANCY

A. **Tenant agrees:**

1. To occupy the Premises in a safe and careful manner and in compliance with all laws, ordinances, rules, regulations and orders of any governmental bodies having jurisdiction over the Premises, and without committing or permitting waste;
2. To neither do nor suffer anything to be done or kept in or about the Premises which contravenes Landlord's insurance policies or increases the premiums therefore, and if any

such action or use of the Premises shall increase the premiums for Landlord's insurance, Tenant shall be required to reimburse Landlord for such increase within ten (10) days after demand by Landlord;

3. To keep its window, canopy and electric signs (if any) lighted until at least 9:30 P.M. local time of each day or until thirty (30) minutes after the close of each business day, whichever is the later;
4. To permit no reproduction of sound which is audible outside the Premises nor permit odors to be unreasonably dispelled from the Premises;
5. To place no sign on the exterior of the Premises or on the interior surface of any windows of the Premises without Landlord's prior written consent and in accordance with the Tenant Signage Criteria referred to in Exhibit D, attached hereto. Tenant, at its sole cost, shall install illuminated channel letter signage in accordance with the Tenant Signage Criteria. Such signage is subject to the prior written approval of Landlord and the approval of all governmental bodies having jurisdiction over same. Tenant shall submit three (3) copies of complete sign packages for Landlord review and written approval prior to submission to the City of Long Beach. Tenant shall maintain all signs placed upon the Premises by Tenant in good condition and repair. Tenant agrees not to display any banners, pennants, search lights, window signs, balloons, or similar temporary advertising media on or about the Premises. Upon vacating the Premises, Tenant agrees to remove all signs installed by Tenant and repair all damage caused by such removal in accordance with Article XI, Section D, of this Lease;
6. To place no merchandise, sign or other thing of any kind in the vestibule or entry of the Premises or on the sidewalks or other Common Areas adjacent thereto;
7. To park Tenant's vehicles and to require all employees to park only in such places as may be designated from time to time by Landlord for the use of Tenant and its employees, and specifically not to permit parking of any Tenant or employee vehicles in any service court area. Landlord reserves the right to impose fines against Tenant for any violation of these parking restrictions by Tenant and/or Tenant's employees and to have towed, at Tenant's cost and expense, any automobile parked in violation of this Section;
8. To keep any rubbish, garbage and waste generated by Tenant from the Premises in proper dumpsters provided by Tenant adjacent to the premises or such other area designated by Landlord from time to time until such rubbish, garbage and waste is removed from the Shopping Center and to permit no refuse to accumulate around the exterior of the Premises;
9. To neither load nor unload or permit the loading or unloading of merchandise, equipment or other property from any doors of the Premises that open onto the front sidewalk areas, nor from any other doors except from the rear of the Premises and to use its best efforts to prevent the parking or standing of vehicles and equipment upon Shopping Center land except when actually engaged in loading or unloading. In the event Tenant violates this covenant, Tenant shall have twenty-four (24) hours following receipt of notice from Landlord (which notice may be given by personal delivery to the Premises including, but not limited to, oral notice by Landlord's representative at the Shopping Center) to cease such activity or be deemed to be in default under this Lease, notwithstanding any cure periods set forth in Article XVI, and Landlord shall have the immediate right to evoke any legal or equitable remedies to enjoin Tenant from such activity;

10. To conduct no auction, fire, bankruptcy, liquidation or going-out-of-business sale without the prior written consent of Landlord;
11. To permit Landlord free access to the Premises, upon twenty-four (24) hour advance notice, at all reasonable times (except in the event of emergency) for the purpose of (i) examining or making repairs or alterations to the Premises or the building in which the Premises are located that Landlord may deem necessary or desirable for the safety or preservation thereof or which may be required to comply with applicable law; (ii) posting notices of nonresponsibility; (iii) performing services required to be performed by Landlord; or (iv) performing any covenant required to be performed by Tenant that Tenant fails to perform after any applicable cure period;
12. Not to permit to be attached or recorded against the Premises or any other portion of the Shopping Center any lien, encumbrance or charge arising out of any work performed or materials furnished by any contractor, mechanic, laborer, or materialman for or at the request of Tenant. Tenant will not enter into any mortgages, conditional sale, security agreement or the like instrument nor suffer any other matter or thing whereby the estate, right and interest of Landlord in the Premises or any part thereof might be impaired or diminished. If any lien or notice of lien on account of an alleged debt of Tenant or any notice of contract by a party engaged by Tenant or Tenant's contractor to work on the Premises is filed against the Premises or any part of the Shopping Center, Tenant will, within ten (10) calendar days after notice of the filing thereof, cause the same to be discharged of record by payment, deposit, bond, order of a court of competent jurisdiction, letter of credit or other adequate security. If Tenant fails to cause such lien or notice of lien to be discharged within such period, Landlord may, but shall not be obligated to, discharge the same either by paying the amounts claimed to be due or by procuring the discharge of such lien by deposit, bond or otherwise, and Tenant shall, immediately upon demand, reimburse Landlord for any and all costs and expenses incurred by Landlord to discharge such lien including, without limitation, all attorneys' fees, court costs and similar expenses, plus an administrative fee equal to fifteen percent (15%) of all out of pocket costs incurred by Landlord. In addition, Tenant shall indemnify and hold Landlord and Landlord's lender, if any, harmless from and against all loss, cost, expense and liability whatsoever (including Landlord's cost of defending against the foregoing, such cost to include attorneys' fees) resulting or occurring by reason of any claims or causes of actions that may arise as a result of any lien, notice of lien or, claim relating to work and/or materials furnished to the Premises at the request of Tenant, its employees, agents or contractors;
13. To solicit no business in the Common Areas, nor distribute handbills or other advertising matter to customers, nor place the same in or on automobiles in the Common Areas;
14. To comply with all reasonable rules and regulations which Landlord may from time to time establish for the use and care of the Premises and the Common Areas;
15. Omitted;
16. Omitted;
17. To participate in any reasonable window cleaning and exterminating programs that may be established by Landlord provided that Landlord gives Tenant reasonable advance notice of such programs;
18. To prohibit the operation on the Premises or in any part of the Shopping Center of any coin or token-operated vending machines, video games or similar devices;

19. To permit Landlord or its agents, during the ninety (90) day period preceding the expiration of the Term of this Lease, to show the Premises to potential tenants, and to place on the Premises notices offering the Premises for lease or sale; and
20. That it shall not make any penetrations through the roof of the Premises without the prior written consent of Landlord.
21. To defend, protect, indemnify and hold Landlord harmless from and against any and all claims, causes of action, liabilities, damages, costs and expenses, including without limitation, attorney fees, arising because of any alleged personal injury, property damage, death, nuisance, loss of business or otherwise, by Landlord, any employee of Landlord, or from and against any governmental act or enforcement, arising from or in any way connected with conditions existing or claimed to exist with respect to Hazardous Materials (as hereinafter defined) within the Shopping Center which are the result of Tenant's use, occupancy or operation of the Premises. As used herein the term "Hazardous Materials" shall be defined as any hazardous substance, contaminant, pollutant or hazardous release (as such terms are defined in any federal, state or local law, rule, regulation or ordinance, including without limitation, the Comprehensive Environmental Response, Compensation and Liability Act of 1980, as amended) and other said wastes;.
22. In the event Tenant shall cause or permit the presence of Hazardous Materials in, on or under the Premises or any other portion of the Shopping Center, Tenant shall promptly, at Tenant's sole cost and expense, take any and all action necessary (as required by appropriate government authority or otherwise) to return the areas affected thereby to the condition existing prior to the presence of any such Hazardous Materials thereon, subject to Landlord's prior written consent. The foregoing covenants shall survive termination of this Lease;
23. In the event Landlord elects to make any additions or changes to the Premises and/or Shopping Center, Tenant shall, upon Landlord's request: (i) temporarily relocate at Landlord's expense; and/or (ii) modify Tenant's signage at Tenant's expense to conform to Landlord's re-designed signage criteria, then in effect, that applies to the Shopping Center, provided such requirements are uniformly applied and enforced. In no event shall Tenant be required to modify its signage more than once every five years as long as the requested change is not mandated by law or local regulation.
24. Tenant acknowledges that the rear access corridor is not meant to be handicap accessible or available to the general public but shall be available in the event of an emergency. Handicap accessibility to the Premises is through the storefront doors facing Pine Avenue.

XI. REPAIRS AND ALTERATIONS

- A. **Repairs by Landlord.** Landlord shall keep the foundations, roof, and structural portions of the outer walls of the Premises in good repair, except for repairs required thereto by reason of the acts of Tenant, Tenant's employees, agents, invitees, licensees, or contractors. Notwithstanding anything herein to the contrary, some or all of these repairs will be subject to inclusion in Tenant's Common Area Charge, including, but not limited to, the cost of painting of the outer walls of the Shopping Center buildings including the Premises. Tenant shall give Landlord written notice of the necessity for repairs coming to the attention of Tenant following which Landlord shall have a reasonable time to undertake and complete such repairs. The provisions of this Article XI, Section A, shall not apply in the case of damage or destruction by fire or other

casualty or by Eminent Domain, in which events the obligations of Landlord shall be controlled by either Article XIII or Article XV hereof.

Anti-graffiti film has been installed on all storefront windows and doors by Landlord. Tenant shall notify Landlord when etched graffiti occurs on its Premises and its need of repair. Landlord is responsible for maintaining the storefront windows and doors, including the anti-graffiti film. Landlord shall be responsible to remove etched anti-graffiti film and replace it with new anti-graffiti film when necessary. Tenant shall reimburse Landlord within fifteen business days of receipt of an invoice for such anti-graffiti film maintenance.

It is expressly understood that Landlord shall not be responsible for any portions of the Premises constructed by Tenant or any prior occupant of the Premises.

- B. Repairs by Tenant.** Except as provided in Article XI, Section A, Tenant shall keep the Premises and any fixtures, facilities, signs or equipment contained therein, in good condition and repair, including, but not limited to, exterior and interior portions of all doors, door checks and operations, windows, plate glass, and showcases surrounding the Premises, the heating, air conditioning, electrical, plumbing and sewer systems, the exterior doors, window frames, and all portions of the store front area, and shall make any replacements thereof and of all broken and/or cracked plate and window glass which may become necessary during the term of this Lease, and any renewals thereof, excepting any repairs to items of Landlord's original construction made necessary by reason of damage due to fire or other casualty covered by standard fire and extended coverage insurance. In connection with Tenant's obligation to maintain the HVAC system servicing the Premises, Tenant shall, during the Term of this Lease, and any renewals thereof, at its sole cost and expense, maintain a service contract for the routine performance of standard HVAC system maintenance, including but not limited to, periodic replacement of filters, oiling of mechanical components and inspection for wear and tear. Landlord reserves the right to designate an HVAC contractor with whom Tenant shall contract for such routine HVAC maintenance so long as the fee charged by Landlord's designated contractor shall be the same or less than the fee charged by Tenant's contractor for similar services. If Tenant fails to commence or complete repairs promptly and adequately, Landlord may make or complete said repairs and Tenant shall pay the cost thereof to Landlord upon demand, together with the sum of fifteen percent (15%) of said costs for overhead and an additional sum equal to ten percent (10%) of said amount for profit.
- C. Alterations or Improvements by Tenant.** Tenant shall not, without Landlord's prior written consent, make, nor permit to be made, any alterations, additions or improvements to the Premises which Landlord can withhold in its sole discretion. Any alterations which may be permitted by Landlord shall be based upon plans and specifications submitted by Tenant and approved by Landlord and upon the condition that Tenant shall promptly pay all costs, expenses, and charges thereof, shall make such alterations and improvements in accordance with applicable laws and building codes and ordinances and in a good and workmanlike manner, and shall fully and completely indemnify Landlord against any mechanic's lien or other liens or claims in connection with the making of such alterations, additions, or improvements. Tenant shall promptly repair any damages to the Premises, or to the buildings of which the Premises are a part, caused by any alterations, additions or improvements to the Premises by Tenant.
- D. Removal of Improvements.** All items of Landlord's construction, all heating and air conditioning equipment, and all alterations, additions and other improvements by Tenant shall become the property of Landlord and shall not be removed from the Premises. All trade fixtures, furniture, furnishings, and signs installed in the Premises by Tenant and paid for by Tenant shall remain the property of Tenant and may be removed upon the expiration of the term of this Lease;

provided (i) that any of such items as are affixed to the Premises and require severance may be removed only if Tenant repairs any damage caused by such removal and (ii) that Tenant shall have fully performed all of the covenants and agreements to be performed by Tenant under the provisions of this Lease. If Tenant fails to remove such items from the Premises prior to the expiration or earlier termination of this Lease, all such trade fixtures, furniture, furnishings, and signs shall become the property of Landlord unless Landlord elects to require their removal, in which case Tenant shall promptly remove same and restore the Premises to its prior condition. In the event Tenant fails to remove all such trade fixtures, furniture, furnishings, and signs within ten (10) days after Landlord elects to require their removal, Landlord shall have the right to remove same and sell such trade fixtures, furniture, furnishings, and signs to pay for the cost of removal. Notwithstanding anything contained to the contrary in this Lease, if Tenant removes such items from the Premises but fails to repair any damage caused by such removal, Landlord may make or complete said repairs without providing Tenant notice prior to the commencement of said repairs. Tenant shall pay the cost thereof to Landlord upon demand, together with the sum of fifteen percent (15%) of said costs for overhead and an additional sum equal to ten percent (10%) of said amount for profit. Tenant's obligations under this Section D shall survive the termination of this Lease.

XII. INDEMNITY AND INSURANCE

- A. **Indemnification by Tenant.** Subject to limitations contained in Section 2782 of the California Civil Code that prohibit the Landlord from being indemnified from its sole negligence or wilfull misconduct, Tenant will indemnify and hold Landlord harmless from and against all loss, cost, expense, and liability whatsoever (including Landlord's cost of defending against the foregoing, such cost to include attorney's fees) resulting or occurring by reason of Tenant's construction, use or occupancy of the Premises.
- B. **Commercial General Liability Insurance.** Tenant agrees to carry commercial general liability insurance including Products and Completed Operations coverage in companies and in a form satisfactory to Landlord with an A.M. Best Rating or its equivalent of A-VIII or better or self insurance equivalent in coverage scope to ISO CG 00 01 10 93 covering the Premises and Tenant's use thereof with a minimum limit of One Million and 00/100 Dollars (\$1,000,000.00) per occurrence and a minimum limit of Two Million Dollars (\$2,000,000.00) general aggregate. Such insurance shall also provide that the general aggregate limits apply separately as to the Premises. Tenant shall deposit with Landlord prior to the date of any use or occupancy of the Premises by Tenant certificates evidencing the required coverages. Tenant's insurance policy shall name Landlord and such other parties as Landlord may from time to time designate in writing to Tenant as additional insureds under Tenant's insurance policy and shall bear endorsements to the effect that the insurer agrees to notify all additional insureds not less than thirty (30) days in advance of any modification or cancellation thereof.

Landlord, subject to reimbursement from Tenant as part of Tenant's Insurance Charge, shall procure and maintain in full force and effect (i) commercial general liability insurance, insuring against liability for bodily injury or property damage occurring in the Shopping Center, in an amount not less than \$1,000,000 per occurrence, \$1,000,000 general aggregate. In Landlord's sole discretion, Landlord may carry increased amounts of such coverage and/or may carry such additional insurance of such types and amounts as Landlord may determine.

- C. **Landlord's Liability.** Subject to limitations contained in Section 2782 of the California Civil Code that prohibit the Landlord from being indemnified from its sole negligence or wilfull misconduct, Landlord shall not be liable (i) for any damage to Tenant's property located in the Premises, regardless of the cause of such damage, (ii) for any acts or omissions of other tenants of

the Shopping Center, nor (iii) for any condition of the Premises whatsoever unless Landlord is responsible for the repair thereof, and has failed to make such repair after notice from Tenant of the need therefore, and expiration of a reasonable time for the making of such repair.

- D. Special Form Coverage Insurance.** Landlord agrees to carry policies insuring the improvements on the Shopping Center constructed by Landlord against fire and such other perils as are normally covered by extended coverage endorsements in the county where the Premises are located, in an amount equal to at least eighty percent (80%) of the insurable value of such improvements, together with insurance against such other risks (including, but not limited to, earthquake, flood, loss of rent and such other coverages as Landlord, in its reasonable discretion, deems appropriate for similarly located shopping centers) and in such amounts as Landlord deems appropriate. At Landlord's election, coverage may include windstorm, impact by aircraft or vehicle, smoke damage, water damage, flood, sprinkler leakage, riot, civil commotion, or terrorist acts. In Landlord's sole discretion, Landlord may carry increased amounts of such coverage and/or may carry such additional insurance of such types and amounts as Landlord may determine.

Tenant agrees that Tenant's contribution to the foregoing insurance shall be as provided for in Article I, Section 13 and Article XII, Section F, of this Lease and that Tenant shall pay its share of the foregoing insurance per said Articles; provided, however, that Tenant shall have no rights in said policy or policies maintained by Landlord and shall not, by reason of such reimbursement, be entitled to be a named insured thereunder. In the event any of Landlord's policies insures Premises or risks other than the Shopping Center or the rents there from, the statement of the insurer shall be conclusive as to the portion of the total premium attributable to the Shopping Center.

Tenant agrees to carry insurance against fire and such other risks as are, from time to time, included in standard extended coverage endorsements, insuring all leasehold and building improvements in the Premises which were originally constructed by Tenant, Tenant's stock-in-trade, trade fixtures, furniture, furnishings, special equipment, floor and wall coverings, and all other items of personal property of Tenant located on or within the Premises, such coverage to be in an amount equal to at least one hundred percent (100%) of the replacement cost thereof. Tenant's insurance policy hereunder shall name Landlord and such other parties as Landlord may from time to time designate in writing to Tenant as loss payee under Tenant's insurance policy as its interests may appear. Prior to the commencement of the Term of this Lease, Tenant shall furnish Landlord with a certificate evidencing such coverage.

- E. Mutual Waiver of Subrogation.** All insurance policies required to be carried by either party covering the Premises, shall to the extent permitted by law expressly waive any right on the part of the insurer against the other party. Tenant and Landlord further agree to waive all claims, causes of action and rights of recovery against the other, and their respective agents, officers, and employees, for any injury to or death of persons or any damage or destruction of persons, property or business which shall occur on or about the Premises originating from any cause whatsoever including the negligence of either party and their respective agents, officers, and employees to the extent such injury, death or property damage is required to be covered by self insurance coverage or a policy or policies maintained by either Landlord or Tenant pursuant to this Lease.

In addition, Tenant hereby releases all claims related to the Premises or the Shopping Center that Tenant may have against Wal-Mart Real Estate Business Trust, a Delaware business trust ("Wal-Mart"), its employees and agents for damages to any property (real and personal) owned by

Tenant and covered by insurance as set forth in this Lease, even if such loss or damage shall be caused by the fault or negligence of Wal-Mart, its employees or agents.

- F. **Insurance Charge.** Commencing on the Rent Commencement Date, Tenant agrees to pay to Landlord, in monthly installments, in advance on the first day of each month, the amount specified in Article I (A), Section 13, as a contribution toward Landlord's cost of carrying commercial general liability, property, fire and extended coverage and earthquake insurance and such other insurance as Landlord deems appropriate, including, but not limited to Tenant's Proportionate Share of the premiums payable for Landlord's insurance provided in Article XII and any additional amounts charged by landlord for deductibles incurred by Landlord in connection with any loss. Such coverage shall be for those items set forth in Article XII, Sections B and D, and shall specifically exclude Tenant's personal property.

Tenant's Insurance Charge shall be paid in monthly installments on the first day of each month in an amount to be estimated by Landlord. Landlord's initial estimate of the Tenant's Insurance Charge is set forth in Article I (A), Section 13. Landlord shall have the right to adjust such estimate from time to time but no more than three times per calendar year. Subsequent to the expiration of the period used by Landlord in estimating Tenant's Insurance Charge, Landlord shall furnish to Tenant a statement of the actual amount of Tenant's Insurance Charge for such period and within fifteen (15) days after receipt of such statement, Tenant shall pay to Landlord or Landlord shall remit to Tenant, as the case may be, the difference between the estimated amounts paid by Tenant and the actual amount of Tenant's Insurance Charge for such period as shown by such statement. At Landlord's option, Landlord may credit Tenant's overpayment to Tenant's Insurance Charges next becoming due.

- G. **Workers' Compensation.** Tenant agrees that commencing on the date Tenant first enters the Premises, Tenant shall, at Tenant's sole cost and expense, provide and maintain or cause to be provided and maintained workers' compensation insurance (meeting the requirements of the state workers' compensation laws) and employer liability insurance covering all of Tenant's employees at the Premises. Tenant shall also use good faith efforts to ensure all contractors, sub-contractors, vendors, leased employees, and temporary employees are properly insured for workers' compensation.
- H. **Self Insurance.** Any insurance requirements of Tenant under this Lease and all Exhibits hereto may be satisfied by the provision by Tenant to Landlord of evidence of self-insurance. However, notwithstanding the foregoing, Tenant shall cause its contractors or agents performing any work connected with or in the Premises, including Tenant's Contractor and Tenant's Representative, to provide liability insurance with a limit as provided above naming Landlord, Landlord's Lender, Landlord's affiliates and Landlord's property management agents as additional insureds.

XIII. DAMAGE AND DESTRUCTION

In the event the Premises are damaged by any peril covered by standard policies of fire and extended coverage insurance, the damage shall, except as hereinafter provided, promptly be repaired by Landlord, at Landlord's expense but, that in no event shall Landlord be required to repair or replace Tenant's stock-in-trade, trade fixtures, furniture, furnishings, equipment or personal property, which shall be the obligation of Tenant to replace to at least equal condition immediately prior to such damage. In the event (a) the Premises are damaged to the extent of twenty-five percent (25%) or more of the cost of replacement of the Premises, (b) the buildings on the Shopping Center are damaged to the extent of fifty percent (50%) or more of the cost of replacement, notwithstanding the extent of damages to the Premises, or (c) any damage to the Premises occurs during the last three (3) years of the term of this Lease, Landlord may elect either to repair or rebuild the Premises or the buildings on the Shopping Center, as the case may be or to terminate this Lease upon giving notice of

such election in writing to Tenant within ninety (90) days after the event causing the damage. If the casualty, repairing, or rebuilding shall render the Premises untenable, in whole or in part, a proportionate abatement of the Minimum Rent in proportion to the sales floor area of the Premises rendered untenable shall be allowed until the date Landlord completes the repairs or rebuilding. The provisions of this Article XIII constitute an express agreement between the parties with respect to any and all damage to, or destruction of, all or any part of the Premises or Shopping Center, and the parties expressly agree that California Civil Code section 1932(2) and 1933(4) and any other current or future statute or other law pertaining to the parties' rights or obligations in connection with damage or destruction shall have no application to this Lease and are hereby expressly waived by the parties.

XIV. ASSIGNING AND SUBLETTING

Tenant shall not sublet the Premises or any part thereof nor assign this Lease, without in each case the prior written consent of Landlord, which consent Landlord shall not unreasonably withhold or delay. Assignee or sublessee shall be of similar or better type and quality as those of other occupants of the Shopping Center. When requesting Landlord's consent, Tenant shall supply information as requested by Landlord, such as but not limited to, a business plan, current credit report, current financial statement and asset information. Tenant shall not permit any business to be operated in or from the Premises by any concessionaire or licensee without the prior written consent of Landlord, which consent Landlord may withhold in its sole discretion. In the event Tenant shall request Landlord's consent to an assignment of this Lease or subletting of the Premises, Tenant shall pay Landlord, as a condition to obtaining Landlord's consent the reasonable costs and expenses incurred by Landlord to review and/or prepare documents in connection with such assignment or sublease (including Landlord's reasonable attorneys' fees), which such costs and expenses shall not exceed One Thousand Five Hundred and 00/100 Dollars (\$1,500.00) during the original term of this Lease and shall not exceed Two Thousand and 00/100 Dollars (\$2,000.00) during the Renewal Term of this lease, and, in addition, a consent fee of Five Hundred and 00/100 Dollars (\$500.00) per request, regardless of whether such assignment or sublease is consummated by Tenant. No consent by Landlord shall operate to relieve Tenant and/or Guarantor, if any, from primary liability for the performance of Tenant's obligations under this Lease. Any profits from said assignment or sublease shall be shared with Landlord on a 50%/50% basis as incurred. Notwithstanding the above, Landlord hereby consents to the subleases in the form of Exhibit I to be executed by and between Tenant, as lessor, and (1) Disabled American Veterans, Long Beach Chapter No. 17, (2) The American Legion, Arthur L. Peterson Post 27 and (3) Fleet Reserve Association, Branch 43, ("Sublessees"), to be executed concurrently with this Lease or shortly thereafter, and Landlord acknowledges that no transfer fee or reimbursement of costs and expenses shall be due and payable in connection with such subleases. Each Sublessee must acknowledge in writing to Landlord that they will be bound by the applicable terms of the Lease and shall agree to perform all applicable obligations under the Lease.

Any sale, assignment, bequest, inheritance, transfer or other disposition of shares of Tenant's corporate stock which shall result in a change in the effective voting control of Tenant by the person or persons owning a majority of said corporate shares on the date of this Lease shall be deemed an assignment of this Lease requiring Landlord's prior written consent.

XV. EMINENT DOMAIN

In the event the Shopping Center or any part thereof shall be taken or condemned either permanently or temporarily for any public or quasi-public use or purpose by any authority in appropriate proceedings or by any right of eminent domain, the entire compensation award thereof, including, but not limited to, all damages as compensation for diminution in value of the leasehold, reversion and fee, shall belong to Landlord, without any deduction there from for any present or future estate of Tenant, and Tenant hereby assigns to Landlord all its right, title, and interest to any such award.

Tenant shall have the right to recover from the condemning authority, but not from Landlord, such compensation as may be separately awarded to Tenant.

In the event of a taking under the power of eminent domain of (i) more than twenty-five percent (25%) of the Premises or (ii) a sufficient portion of the Shopping Center so that after such taking less than fifty percent (50%) of the leasable floor area within all buildings located on the Shopping Center (as constituted prior to such taking) are occupied by tenants, either Landlord or Tenant shall have the right to terminate this Lease by notice in writing given within ninety (90) days after the condemning authority takes possession, in which event all rents and other charges shall be prorated as of the date of such termination.

In the event of a taking of any portion of the Premises not resulting in a termination of this Lease, Landlord shall use so much of the proceeds of Landlord's award for the Premises as is required therefore to restore the Premises to a complete architectural unit and this Lease shall continue in effect with respect to the balance of the Premises, with a reduction of Minimum Rent in proportion to the portion of the Premises taken.

Tenant hereby waives any and all rights it might otherwise have pursuant to California Code of Civil Procedure Section 1265.130 and any successor statute or law.

XVI. DEFAULT BY TENANT

If Tenant defaults in the payment of Minimum Rent, Percentage Rent or other charges and such payment is not made within five (5) days following Landlord's written notice that same is due, or if Tenant shall default in the performance of any other of Tenant's obligations hereunder and Tenant fails to remedy such default within fifteen (15) days after written notice from Landlord, provided that in no event shall Landlord be obligated to provide Tenant with written notice of any default, monetary or otherwise, more than once per calendar year, or if a receiver of any property of Tenant on the Premises is appointed, or Tenant's interest in the Premises is levied upon by legal process, or Tenant be adjudged bankrupt and Tenant fails within thirty (30) days to cause the vacation of such appointment, levy or adjudication, or if Tenant files a voluntary petition in bankruptcy, disposes of all or substantially all of its assets in bulk, or makes an assignment for the benefit of its creditors, then and in any such instance, without further notice to Tenant, Landlord shall have the right to exercise any and all rights or remedies available to Landlord at law, in equity or otherwise, arising from such default, including but not limited to the right to (i) terminate this Lease, or (ii) enter upon the Premises without terminating this Lease and relet the Premises in Landlord's name for the account of Tenant for the remainder of the term upon terms and conditions reasonably acceptable to Landlord and immediately recover from Tenant any deficiency for the balance of the term, plus expenses of reletting. Any notice of default given by Landlord under this Lease shall be in lieu of, and not in addition to, any notice required under California Code of Civil Procedure Section 1161 or any similar or successor statute or law. In addition to the foregoing, any time after such default and the lapse of any applicable notice period, Landlord shall have the right, but not the obligation, to make such payments in default or perform such act in default for the account and at the expense of Tenant, and all unpaid Minimum Rent, Percentage Rent or other charges which are not paid when due and all sums paid by Landlord pursuant to this sentence, including reasonable attorneys' fees, shall accrue interest at the annual rate of (i) fifteen percent (15%), or (ii) five percent (5%) above the prime lending rate of Bank of America, whichever is greater, which shall constitute additional rent under this Lease and shall be payable upon demand. Notwithstanding the foregoing, Landlord shall have no duty to mitigate the damages suffered by Landlord rising from the default by Tenant of any of its obligations under this Lease. If Tenant shall issue a check to Landlord which is dishonored by Tenant's depository bank and returned unpaid for any reason, including without limitation, due to insufficient funds in Tenant's checking account, Tenant shall pay to Landlord in addition to any other

rights or remedies available to Landlord at law, the sum of Seventy-five and 00/100 Dollars (\$75.00) for Landlord's administrative expense in connection therewith.

If Landlord elects to terminate the Lease as a result of a default by Tenant, then in addition and without prejudice to any other right or remedy that Landlord may have under this Lease or at law or equity, Landlord may recover from Tenant the following:

- A. the worth at the time of award of any unpaid rent which had been earned at the time of such termination; plus
- B. the worth at the time of award of the amount by which unpaid rent for the balance of the Term after termination until the time of award exceeds the amount of such rental loss that Tenant proves could have been reasonably avoided; plus
- C. the worth at the time of award of the amount by which unpaid rent for the balance of the Term after the time of award exceeds the amount of such rental loss that Tenant proves could have been reasonably avoided; plus
- D. any other amount necessary to compensate Landlord for all the detriment proximately caused by Tenant's failure to perform its obligations under this Lease or which in the ordinary course of things would be likely to result there from, specifically including but not limited to, brokerage commissions and advertising expenses incurred, expenses of improvements to the Premises or any portion thereof for a new tenant, and any concessions made to obtain a new tenant; and
- E. at Landlord's election, such other amounts in addition to or in lieu of the foregoing as may be permitted from time to time by applicable law.

The term "rent" as used in Paragraphs A through E above shall mean all sums of every nature required to be paid by Tenant pursuant to the terms of this Lease, whether to Landlord or to others. As used in Paragraphs A and B above, the "worth at the time of award" shall be computed by allowing interest at the rate set forth in the first paragraph of this Article XVI, but in no event greater than the maximum rate of interest permitted by law. As used in Paragraph C above, the "worth at the time of award" shall be computed by discounting such amount at the discount rate of the Federal Reserve Bank of San Francisco at the time of award, plus one percent (1%).

In addition to any other remedies of Landlord, Landlord shall have the remedy described in California Civil Code Section 1951.4 (Landlord may continue lease in effect after Tenant's breach and abandonment and recover rent as it becomes due, if Tenant has right to sublet or assign, subject only to reasonable limitations).

Tenant's failure to pay Rent, Additional Rent, or any other Lease costs when due under this Lease may cause Landlord to incur unanticipated costs. The exact amount of such costs are impractical or extremely difficult to ascertain. Such costs may include, but are not limited to, processing and accounting charges and late charges that may be imposed on Landlord by any ground lease, mortgage, or deed of trust encumbering the Shopping Center. Therefore, if Landlord does not receive the Rent, Additional Rent, or any other Lease costs in full on or before the fifth (5th) day of the month it becomes due ("Late Charge Date"), Tenant shall pay Landlord a late charge, which shall constitute liquidated damages, equal to Fifty Dollars (\$50.00) a day for each day rent is late after the first of the month ("Late Charge"), which shall be paid to Landlord together with such Rent, Additional Rent, or other Lease costs then in arrears. Once per calendar year, the Late Charge Date may be extended by Tenant to the tenth (10th) day of the month. The parties agree that such Late Charge represents a fair and reasonable estimate of the cost Landlord will incur by reason of such late payment. All Late Charges and any returned check charges shall then become Additional Rent and shall be due and

payable immediately along with such other Rent, Additional Rent, or other Lease costs then in arrears. Money paid by Tenant to Landlord shall be applied to Tenant's account in the following order: (i) to any unpaid Additional Rent, including, without limitation, Late Charges, returned check charges, legal fees and/or court costs legally chargeable to Tenant, and Common Area Maintenance Charges, and then (ii) to unpaid Minimum Rent. Nothing herein contained shall be construed so as to compel Landlord to accept any payment of Rent, Additional Rent, or other Lease costs in arrears or Late Charge or returned check charge should Landlord elect to apply its rights and remedies available under this Lease or at law or equity in the event of default hereunder by Tenant. Landlord's acceptance of Rent, Additional Rent, or other Lease costs in arrears or Late Charge or returned check charge pursuant to this clause shall not constitute a waiver of Landlord's rights and remedies available under this Lease or at law or equity.

Tenant agrees to pay to Landlord upon demand, as additional rent, a sum equal to all costs and expenses (including attorney fees, professional fees, costs of investigation and disbursements) incurred by Landlord in enforcing any or all of its rights hereunder, specifically including the cost of collecting sums due, whether or not an action or proceeding is commenced, or levying and collecting on any judgment or arbitration award in Landlord's favor.

All rights and remedies of Landlord herein enumerated shall be cumulative, and none shall exclude any other remedies allowed at law or in equity.

XVII. NOTICES

Any notice or consent required to be given by or on behalf of either party to the other shall be given in writing and mailed by certified mail or by overnight courier service which provides a receipt, at the addresses stated on Article I (A), Sections 18 and 19, of this Lease, or at such other address as may be specified, from time to time, by notice in the manner herein set forth. Notices shall be deemed given upon actual receipt or first rejection.

XVIII. SECURITY DEPOSIT

Not applicable to Tenant.

XIX. MORTGAGE SUBORDINATION

Landlord shall use best efforts to obtain an executed Subordination, Non-Disturbance and Attornment Agreement from Landlord's current lender similar to the Agreement in Exhibit G.

This Lease, and Tenant's rights hereunder shall be subject and subordinate to the lien of any mortgages or deeds of trust or other similar instrument that may now exist or may hereafter be placed upon the Shopping Center and all renewals, replacements, and extensions thereof without further notice or action on the part of Landlord or Tenant. Tenant agrees that, within fifteen (15) days upon the request of Landlord, it shall execute and deliver such instruments (including but not limited to a Memorandum of Lease and/or a Subordination, Non-Disturbance and Attornment Agreement in recordable form) which may be required by Landlord's mortgagee or trustee to evidence such subordination. If Tenant fails to execute and deliver any such documents or agreements within fifteen (15) days after written request by Landlord, Tenant shall be in default.

Tenant covenants and agrees that if any proceedings are brought for the foreclosure of any such mortgage or deed of trust, then at the request of the purchaser at such foreclosure Tenant shall attorn to such purchaser, without any deductions or set-off's, and recognize such purchaser as the landlord under this Lease. Tenant waives they provisions of any current or future statute or law that may give or purport to give Tenant any right or election to terminate or otherwise adversely affect this Lease and the obligations of the Tenant hereunder in the event of any foreclosure proceeding or sale.

XX. ESTOPPEL CERTIFICATES

At any time and from time to time, Tenant agrees, within fifteen (15) days upon request in writing from Landlord, to execute and deliver to Landlord, for the benefit of such persons as Landlord names in such request, a statement in writing and in substance satisfactory to Landlord certifying to such of the following information as Landlord shall request: (i) that this Lease constitutes the entire agreement between Landlord and Tenant and is unmodified and in full force and effect (or if there have been modifications, that the same is in full force and effect as modified and stating the modifications); (ii) the dates to which the Minimum Rent, Percentage Rent, and other charges hereunder have been paid, and the amount of any security deposited with Landlord; (iii) that the Premises have been completed on or before the date of such letter and that all conditions precedent to the Lease taking effect have been carried out; (iv) that Tenant has accepted possession, that the Term of the Lease has commenced, that Tenant is occupying the Premises, that Tenant knows of no default under the Lease by Landlord and that there are no defaults or offsets which Tenant has against enforcement of this Lease by Landlord; (v) the actual Rent Commencement Date of the Lease and the Expiration Date of the Lease; and (vi) that Tenant's store is open for business, provided such facts are true and ascertainable.

Failure to deliver this certificate within fifteen (15) days after notice from Landlord shall be conclusive that this Lease is in full force and effect and has not been modified except as may be represented by the Landlord. In addition, if Tenant fails to execute and deliver the certificate within the same fifteen (15) day period, Tenant shall be in default.

XXI. QUIET ENJOYMENT

Landlord hereby covenants and agrees that if Tenant shall perform all the covenants and agreements herein stipulated to be performed on Tenant's part, Tenant shall at all times during the continuance hereof have the peaceable and quiet enjoyment and possession of the Premises without any hindrance from Landlord or any person or persons lawfully claiming the Premises.

XXII. LIABILITY OF LANDLORD

Notwithstanding anything to the contrary provided in this Lease, it is specifically understood and agreed, such agreement being a primary consideration for the execution of this Lease by Landlord, that if Landlord shall fail to perform any covenant, term or condition of this Lease upon Landlord's part to be performed and, as a consequence of such default, Tenant shall recover a money judgment against Landlord, such judgment shall be satisfied only out of the proceeds of sale received upon execution of such judgment and levy thereon against the right, title, and interest of Landlord in the Shopping Center, as the same may then be encumbered, and neither Landlord nor any of its officers or shareholders shall be liable for any deficiency. It is understood that in no event shall Tenant have any right to levy execution against any property of Landlord other than its interest in the Shopping Center as hereinbefore expressly provided. In the event of the sale or other transfer of Landlord's right, title and interest in the Premises or the Shopping Center, Landlord shall be released from all liability and obligations under this Lease arising after the date of such sale or other transfer.

XXIII. MISCELLANEOUS PROVISIONS

- A. **Accord and Satisfaction.** No payment by Tenant, or anyone occupying the Premises by, through or under Tenant, or receipt by Landlord of a lesser amount than the rents stated herein shall be deemed to be other than on behalf of Tenant and on account of the next due rent, nor shall any endorsement or statement on any check or any letter accompanying any check or payment as rent be deemed an accord and satisfaction, and Landlord may accept such check or payment without prejudice to Landlord's right to recover the balance of such rent or pursue any other remedy provided for in this Lease or available at law or in equity.

- B. Waiver.** No waiver of any condition or legal right or remedy shall be implied by the failure of Landlord to declare a forfeiture, or for any other reason, and no waiver of any condition or covenant shall be valid unless it be in writing signed by Landlord. No waiver by Landlord with respect to one or more tenants or occupants of the Shopping Center shall constitute a waiver in favor of any other tenant, nor shall the waiver of a breach of any condition be claimed or pleaded to excuse a future breach of the same condition or covenant.
- C. Broker's Commission.** Tenant warrants that, except for any amounts payable by Landlord to its agent named in Article I (A) Section 21, there are no claims for broker's commissions or finder's fees in connection with its execution of this Lease, and Tenant agrees to indemnify and save Landlord harmless from any liability that may arise from such claims, including reasonable attorney's fees.
- D. No Partnership.** Landlord does not, in any way or for any purpose, become a partner of Tenant in the conduct of its business, or otherwise, or a joint venturer or a member of a joint enterprise with Tenant.
- E. Lease Inures to the Benefit of Assignees.** This Lease and all of the covenants, provisions, and conditions herein contained shall inure to the benefit of and be binding upon the heirs, personal representatives, successors and assigns respectively, of the parties hereto, provided, however, that no assignment by, from, through, or under Tenant in violation of the provisions hereof shall vest in the assigns any right, title, or interest whatsoever.
- F. Entire Agreement.** This Lease and the exhibits attached hereto set forth the entire agreement between Landlord and Tenant, and all prior promises and agreements, oral or written, between them are merged into this Lease. No amendment to this Lease shall be binding upon Landlord or Tenant unless in writing.
- G. Abandonment, Surrender and Holding Over.** Tenant shall deliver up and surrender to Landlord possession of the Premises upon the expiration of the Lease Term, or its prior termination for any reason, in as good condition and repair as the same shall be at the commencement of said term (damage by fire and other perils covered by standard fire and extended coverage insurance and ordinary wear and decay only excepted). At the time Tenant shall deliver and surrender possession of the Premises to Landlord, Tenant shall provide Landlord with a written statement from an HVAC contractor reasonably acceptable to Landlord who shall certify that the HVAC system servicing the Premises has been properly maintained and is in good working order. In the event Tenant shall fail to provide such statement to Landlord, Landlord shall have the right, but not the obligation without prior notice to Tenant to retain an HVAC contractor of Landlord's choosing who shall inspect the HVAC system servicing the Premises and report to Landlord as to the condition of said HVAC system. If such report discloses the need for repair or maintenance, Landlord shall have the right, but not the obligation, without prior notice to Tenant, to cause such repairs or maintenance. Tenant shall reimburse Landlord for all costs and expenses so incurred by Landlord in performing the inspection, maintenance and/or repairs plus an additional ten percent (10%) of such cost for and as Landlord's overhead. If Tenant remains in possession of the Premises after any termination of this Lease, Tenant shall be bound by the terms and provisions of this Lease except that no tenancy or interest in the Premises shall result, but such holding over shall be an unlawful detainer and all such parties shall be subject to immediate eviction, and Tenant shall upon demand pay to Landlord, as liquidated damages, a sum equal to one hundred fifty percent (150%) of the Minimum Rent payable during the calendar month immediately preceding the expiration or earlier termination of this Lease for any period during which Tenant shall hold the Premises after the stipulated term of this Lease shall expire or may have terminated. If Tenant vacates the Premises prior to the scheduled expiration of the

Lease Term, Tenant shall be in default of this Lease, and if Tenant has not re-entered the Premises and resumed the operation of the business set forth in Article IX, Section B, of this Lease for a period of ninety (90) consecutive days, Tenant shall be deemed to have abandoned the Premises, and Landlord shall have the right, but not the obligation, to take sole possession of the Premises on or after the tenth (10th) day following the expiration of said ninety (90) day period and Landlord may relet said Premises in accordance with the terms in Article XVI hereof.

- H. **No Option.** The submission of this Lease by Landlord for review by Tenant does not constitute a reservation of or option for the Premises, and shall vest no right in Tenant. This Lease becomes effective as a Lease only upon execution and delivery thereof by the parties hereto.
- I. **Additional Rent.** Any amounts to be paid by Tenant to Landlord pursuant to the provisions of this Lease, whether such payments are periodic or recurring, shall be deemed to be "Additional Rent" and otherwise subject to all provisions of this Lease and of law as to the default in the payment of rent.
- J. Omitted.
- K. **Financial Statements .** Within ten (10) business days after receipt of a written request from Landlord, not to occur more than once per year, Tenant shall provide Landlord with a copy of Tenant's most recent financial statement that has been made available to the public.
- L. **Severability.** In the event that any provision or section of this Lease is rendered invalid by the decision of any court or by the enactment of any law, ordinance or regulation, such provision of this Lease shall be deemed to have never been included therein, and the balance of this Lease shall continue in effect in accordance with its terms.
- M. **Option to Renew.** Provided Tenant is not in default under any of the terms and provisions herein contained and is in occupancy and conducting business from the Premises, Landlord hereby grants to Tenant the Options to Renew this Lease for the Renewal Terms set forth in Article I (A), Section 17, commencing on the day following the expiration of the Term, as such Term may have been extended by the exercise of a previous Option to Renew. Any such Renewal Term shall be upon all the terms and conditions as the original Term except that the Minimum Rent shall be increased in accordance with the terms of the Rent Schedule attached to this Lease as Schedule A.
- The foregoing Option to Renew shall be exercised by written notice to Landlord given not less than the number of months set forth in Article I (A), Section 17, above prior to the expiration of the original term of this Lease, or any renewal thereof. Tenant's Options to Renew the Lease are personal to the original Tenant executing this Lease and may not be assigned or transferred by Tenant without Landlord's prior written consent.
- N. **Net Rent.** It is the intention of Landlord and Tenant that the rent herein specified shall be net to Landlord in each year of the term hereof, and that all costs, expenses and obligations relating to the Premises (except as herein specifically provided) shall be paid by Tenant.
- O. **Counterparts.** This Lease may be executed in multiple counterparts, each of which shall constitute an original and all of which shall constitute one document.
- P. **Consents.** With respect to any provision of this Lease which provides or infers, in effect, that Landlord shall not unreasonably withhold or unreasonably delay its consent or approval, Tenant, in no event, shall be entitled to make, nor shall Tenant make, any claim against Landlord for money damages, and Tenant hereby waives any claim or assertion by Tenant that Landlord has unreasonably withheld or unreasonably delayed any consent or approval, but Tenant's sole remedy shall be an action or proceeding to enforce any such provision of this Lease, or for

specific performance, injunction or declaratory judgment. In all cases where consent or approval shall be required either of Tenant or Landlord pursuant to this Lease, the giving of this consent shall not be unreasonably withheld or delayed by the party from whom such consent is required.

- Q. Force Majeure.** In the event Landlord or Tenant is prevented or delayed in the performance of any improvement or repair or fulfilling any other obligation required under this Lease due to delays caused by fire, catastrophe, strikes or labor trouble, civil commotion, acts of God, governmental prohibitions or regulation, inability or difficulty to obtain materials or other causes beyond the performing party's reasonable control, the performing party shall, within ten (10) days of the event causing such delay, provide written notice to the other party of the event causing the delay and the anticipated period of delay, and the period of such delay shall be added to the time for performance thereof. The performing party shall have no liability by reason of such permitted delays. In the event the performing party fails to provide notice to the other party of the force majeure delay within such ten (10) day period, the performing party shall not be excused from the timely performance of such obligation regardless of the cause.
- R. Joint and Several Liability.** In the event Tenant shall be comprised of more than one (1) individual or business entity, each such individual or business entity comprising Tenant shall be jointly and severally liable for each and every obligation of Tenant under the terms of this Lease.
- S. Right to Relocate.** As a material inducement for Landlord to enter into this Lease with Tenant, Landlord shall, commencing with the 37th month of the Lease and continuing throughout the remaining Term of this Lease and any renewals thereof, have the right at Landlord's expense (including without limitation expenses for cabling, tenant improvements, moving, construction management and stationery) to relocate Tenant to other premises ("New Premises") within the Shopping Center. In the event Landlord elects to exercise the right of relocation, Landlord shall deliver written notice to Tenant identifying the location of the proposed New Premises ("Landlord's Notice"). In the event Tenant shall not agree to the New Premises proposed by Landlord, Tenant shall have the right to terminate this Lease within fifteen (15) business days after the date of Landlord's Notice by delivering written notice to Landlord of its election to terminate in which event, this Lease and the obligations of the parties shall terminate as of the date which is one hundred eighty (180) days after the date of such notice (the "Termination Date"), provided Tenant pays to Landlord all sums and charges due and owing by Tenant to Landlord through and including the Termination Date. Any sum which cannot be exactly determined by Landlord as of the Termination Date shall be paid by Tenant to Landlord within thirty (30) days after Tenant's receipt of a statement therefore. The foregoing obligation shall survive termination of this Lease. If Tenant shall not terminate this Lease within the fifteen (15) business day period set forth above, Tenant shall be deemed to have waived its right to terminate this Lease pursuant to this paragraph, and Tenant shall relocate to the New Premises.
- T. Payment Under Protest.** All rent and other amounts payable hereunder shall be payable without demand, offset or deduction. If at any time a dispute shall arise as to any amount or sum of money to be paid by Tenant to Landlord under the provisions hereof, Tenant shall make such payment "under protest" and under no circumstances shall Tenant be entitled to withhold any payment due hereunder. If Tenant makes a payment "under protest" and it is subsequently determined that Tenant was not obligated to pay all or a portion of an amount paid "under protest," Landlord shall refund to Tenant the portion of the payment made "under protest" which Tenant was not obligated to pay.
- U. Waiver of Trial By Jury.** To the extent permitted by applicable law Landlord and Tenant waive all right to trial by jury in any claims, action, proceeding or counterclaim by either Landlord or

Tenant against each other or any matter arising out of or in any way connected with this Lease, the relationship of Landlord and Tenant or Tenant's use or occupancy of the Premises.

- V. **Development of Shopping Center.** Tenant acknowledges that the Shopping Center, adjacent parcels and adjacent residential improvements may be developed in several phases and/or modified during the Term. Accordingly, there may be ongoing construction activities in and about the Shopping Center and adjacent areas after Tenant has opened for business and from time to time during the Term. Such construction activities may necessitate the erection of scaffolding and staging areas, involve temporary modifications of access to portions of the Common Areas and parking, create noise, dust or debris, and otherwise temporarily impact Shopping Center operations. As long as Landlord maintains access to the Premises and takes (or causes its other tenants to take) reasonable steps to limit noise, dust and debris, Tenant acknowledges that such construction activities shall not impose any liability on Landlord for interference with Tenant's business or use of the Premises, constitute eviction of Tenant to abate Rent, or otherwise affect the Tenant's obligations under the Lease.
- W. **No Discrimination.** Tenant herein covenants by and for itself, its heirs, executors, administrators and assigns, and all persons claiming under or through Tenant, that this Lease is made and accepted upon and subject to the following condition:
- That there will be no discrimination against or segregation of any person or group of persons, on account of race, color, religion, national origin, sex, sexual orientation, AIDS, AIDS related condition, age, marital status, disability or handicap or Vietnam Era veteran status in the leasing, subleasing, transferring, use, occupancy, tenure or enjoyment of the land herein leased nor shall Tenant itself, or any person claiming under or through Tenant, establish or permit any such practice or practices of discrimination or segregation with reference to the selection, location, number, use or occupancy of tenants, lessees, subtenants, assignees or vendees of the Premises.
- X. **Attorneys Fees.** If either party commences litigation against the other for the specific performance of this Lease, for damages for the breach hereof or otherwise for enforcement of any remedy hereunder, the parties hereto agree to and hereby do waive any right to a trial by jury and, in the event of any such commencement of litigation, the prevailing party shall be entitled to recover from the other party such costs and reasonable attorneys' fees as may have been incurred, including any and all costs incurred in enforcing, perfecting and executing such judgment.
- Y. **Partial Invalidity.** If any term, provision or condition contained in this Lease shall to any extent, be invalid or unenforceable, the remainder of this Lease, or the application of such term, provision or condition to persons or circumstances other than those with respect to which it is invalid or unenforceable, shall not be affected thereby, and each and every other term, provision and condition of this Lease shall be valid and enforceable to the fullest extent possible permitted by law.
- Z. **Miscellaneous.** This Lease shall be construed and enforced in accordance with the laws of the state of California. The captions of Articles and Sections are for convenience only and shall not be deemed to limit, construe, affect or alter the meaning of such Articles and Sections. This Lease shall not be construed or interpreted as if prepared by one of the parties, but rather according to its fair meaning as a whole, as if both parties had prepared the document.
- AA. **Parking.** Pursuant to the Parking Rights Agreement with the City of Long Beach and the Redevelopment Agency of the City of Long Beach, Tenant's employees shall be able to purchase monthly parking passes from the City of Long Beach at the parking garages adjacent to the Shopping Center at the rate specified by the City of Long Beach which is currently \$10 per car per month at the time of preparation of this document. The City of Long Beach may increase the monthly parking rate for employees pursuant to the above referenced agreement.

AB. Rooftop Communication Equipment. Subject to the prior written approval of Landlord and the owner of the Residential Apartments above Building J (“Residential Owner”) and subject to the Covenants, Conditions, Restrictions and Easement Agreement between Landlord and the Residential Owner, Tenant may use a proportional share of the roof of Building J for the installation and use of a microwave dish, antenna or other telecommunications equipment (“Rooftop Equipment”) which is specifically and exclusively used for the daily operations and use of the Premises by Tenant. Tenant shall have no obligation to pay rent for the rooftop space, however, Tenant shall be responsible for all costs of installation and maintenance of the Rooftop Equipment and any connections between the Premises and the Rooftop Equipment. If the Rooftop Equipment causes any damage to the rooftop or Building or any additional maintenance charges, Tenant shall be responsible for all such maintenance and repair costs. Any additional costs to repair the roof or put on a new roof caused by Tenant’s Rooftop Equipment shall be the sole responsibility of Tenant. Landlord and Residential Owner reserve the right to restrict the size, height, weight and location of Tenant’s Rooftop Equipment. Tenant’s Rooftop Equipment shall not cause any interference with other equipment at the Building or already present on the roof. At the expiration or termination of the Lease, whichever is sooner, Tenant shall remove the Rooftop Equipment and any connectors to the Premises and repair any damage caused by the removal at its sole cost. Tenant and its agents shall not perform any work which will invalidate the warranty on the roof and shall use a roofing contractor designated by either Landlord or Residential Owner.

IN WITNESS WHEREOF, Landlord and Tenant have caused this Lease to be signed, in triplicate, as of the date and year first above written.

LANDLORD:

City Place Long Beach, LLC
a Delaware limited liability company

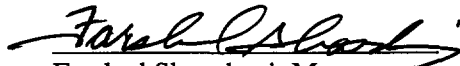
By: 
Farshad Shooshani, Manager

City Place Long Beach TIC I, LLC
a Delaware limited liability company

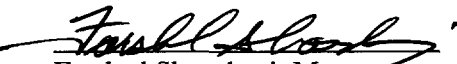
By: 
Farshad Shooshani, Manager

City Place Long Beach TIC 2, LLC
a Delaware limited liability company

By: 
Farshad Shooshani, Manager

TENANT:

City of Long Beach, a municipal corporation

By: 
Gerald R. Miller
(Print Name)

Its: City Manager

APPROVED AS TO FORM

3/9 2007
ROBERT E. SHANNON, City Attorney

By: 
DEPUTY CITY ATTORNEY

CALIFORNIA ALL-PURPOSE ACKNOWLEDGMENT

State of California }
County of Los Angeles } ss.

On 3-21-2007, before me, Rick A. Sloan, Notary Public
Date Name and Title of Officer (e.g., "Jane Doe, Notary Public")
personally appeared FARSHAD TONY SHOOSHANZ
Name(s) of Signer(s)

personally known to me
 ~~proved to me on the basis of satisfactory evidence~~

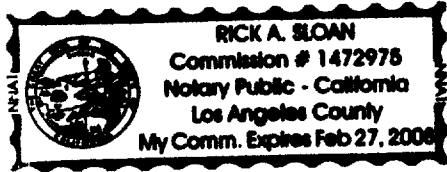

to be the person~~(s)~~ whose name~~(s)~~ is/~~are~~ subscribed to the within instrument and acknowledged to me that he/~~she/they~~ executed the same in his/~~her/their~~ authorized capacity~~(ies)~~, and that by his/~~her/their~~ signature~~(s)~~ on the instrument the person~~(s)~~, or the entity upon behalf of which the person~~(s)~~ acted, executed the instrument.

WITNESS my hand and official seal.

Rick A. Sloan
Signature of Notary Public

Place Notary Seal Above

OPTIONAL

Though the information below is not required by law, it may prove valuable to persons relying on the document and could prevent fraudulent removal and reattachment of this form to another document.

Description of Attached Document

Title or Type of Document: Lease

Document Date: _____ Number of Pages: _____

Signer(s) Other Than Named Above: _____

Capacity(ies) Claimed by Signer

Signer's Name: _____

- Individual
- Corporate Officer — Title(s): _____
- Partner — Limited General
- Attorney in Fact
- Trustee
- Guardian or Conservator
- Other: _____

Signer Is Representing: _____

RIGHT THUMBPRINT OF SIGNER

Top of thumb here

CALIFORNIA ALL-PURPOSE ACKNOWLEDGMENT

State of California }
County of Los Angeles } ss.

On March 19, 2007 before me, LINDA C. RAMSAY, Notary Public
Date Name and Title of Officer (e.g., "Jane Doe, Notary Public")
personally appeared GERALD R. MILLER
Name(s) of Signer(s)

personally known to me
 ~~proved to me on the basis of satisfactory evidence~~

to be the person ~~wh~~ whose name ~~is~~ is are subscribed to the within instrument and acknowledged to me that ~~he~~ she they executed the same in his ~~her~~ their authorized capacity ~~(ies)~~, and that by his ~~her~~ their signature ~~s~~ on the instrument the person ~~or~~ the entity upon behalf of which the person ~~acted~~, executed the instrument.

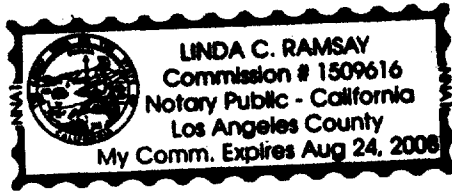

WITNESS my hand and official seal.

Linda C. Ramsay
Signature of Notary Public

OPTIONAL

Though the information below is not required by law, it may prove valuable to persons relying on the document and could prevent fraudulent removal and reattachment of this form to another document.

Description of Attached Document

Title or Type of Document: Lease

Document Date: _____ Number of Pages: 32 plus exhibits

Signer(s)-Other Than Named Above: _____

Capacity(ies) Claimed by Signer

Signer's Name: _____

- Individual
- Corporate Officer — Title(s): _____
- Partner — Limited General
- Attorney-in-Fact
- Trustee
- Guardian or Conservator
- Other: _____

Signer Is Representing: _____

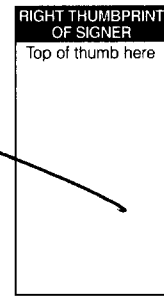

SCHEDULE A

Rent Schedule

<u>Lease Year During Term</u>	<u>Annual Minimum Rent Per Square Foot of Premises</u>	<u>Total Monthly Minimum Rent</u>	<u>Total Annual Minimum Rent</u>
Month 1	\$24.00	\$6,358.00	\$76,296.00
Months 2-5	\$12.00	\$3,179.00	\$38,148.00
Months 6-12	\$24.00	\$6,358.00	\$76,296.00
Year 2	\$24.96	\$6,612.32	\$79,347.84
Year 3	\$25.96	\$6,876.81	\$82,521.75
Year 4	\$27.00	\$7,151.89	\$85,822.62
Year 5	\$28.08	\$7,437.96	\$89,255.53
Option Periods			
Year 6	\$29.20	\$7,735.48	\$92,825.75
Year 7	\$30.37	\$8,044.90	\$96,538.78
Year 8	\$31.58	\$8,366.69	\$100,400.33
Year 9	\$32.85	\$8,701.36	\$104,416.34
Year 10	\$34.16	\$9,049.42	\$108,593.00
Year 11	\$35.53	\$9,411.39	\$112,936.72

EXHIBIT A-1

LEGAL DESCRIPTION

PARCEL 1:

LOTS 6, 8, 9, 12, 13, 14, 15, AND 16 OF TRACT NO. 53306, IN THE CITY OF LONG BEACH, COUNTY OF LOS ANGELES, STATE OF CALIFORNIA, AS PER MAP RECORDED IN BOOK 1261, PAGES 31 THROUGH 34 OF MAPS, IN THE OFFICE OF THE COUNTY RECORDER OF SAID COUNTY.

EXCEPTING THEREFROM ALL OIL, GAS, HYDROCARBON SUBSTANCES AND MINERALS OF EVERY KIND AND CHARACTER LYING MORE THAN 500 FEET BELOW THE SURFACE OF SAID LAND, TOGETHER WITH THE RIGHT TO DRILL INTO, THROUGH AND TO USE AND OCCUPY ALL PARTS OF SAID LAND LYING MORE THAN 500 FEET BELOW THE SURFACE THEREOF FOR ANY AND ALL PURPOSES INCIDENTAL TO THE EXPLORATION FOR AND PRODUCTION OF OIL, GAS, HYDROCARBON SUBSTANCES OR MINERALS FROM SAID LAND OR OTHER LANDS, BUT WITHOUT HOWEVER, THE RIGHT TO USE EITHER THE SURFACE OF SAID LAND OR ANY PORTION OF SAID LAND WITHIN 500 FEET OF THE SURFACE FOR ANY PURPOSE OR PURPOSES WHATSOEVER, AS RESERVED IN VARIOUS DEEDS OF RECORD.

PARCEL 2:

EASEMENT FOR THE PURPOSE OF CONSTRUCTING AND OPERATING A GARDEN CENTER AND ANY AND ALL PURPOSES INCIDENTAL THERETO OVER A PORTION OF LOT 7 OF TRACT NO. 53306, IN THE CITY OF LONG BEACH, COUNTY OF LOS ANGELES, STATE OF CALIFORNIA, AS PER MAP RECORDED IN BOOK 1261, PAGES 31 THROUGH 34 OF MAPS, IN THE OFFICE OF THE COUNTY RECORDER OF SAID COUNTY, AS CREATED BY THE GRANT OF EASEMENT AND AGREEMENT, RECORDED IN THE OFFICIAL RECORDS ON SEPTEMBER 24, 2001 AS INSTRUMENT NO. 01-1799121.

PARCEL 3:

RIGHTS TO PARK IN THE PARKING FACILITIES AS DESCRIBED IN AND SUBJECT TO THE TERMS AND PROVISIONS OF THAT CERTAIN PARKING RIGHTS AGREEMENT DATED SEPTEMBER 21, 2001, EXECUTED BY THE CITY OF LONG BEACH, COVENTRY LONG BEACH PLAZA LLC, AND THE REDEVELOPMENT AGENCY OF THE CITY OF LONG BEACH, RECORDED IN THE OFFICIAL RECORDS ON SEPTEMBER 24, 2001 AS INSTRUMENT NO. 01-1799119.

PARCEL 4:

EXCLUSIVE EASEMENTS FOR ELECTRICAL WIRES AND OTHER UTILITIES EQUIPMENT, HVAC UNITS AND RELATED DUCTWORK, SATELLITE EQUIPMENT, ROOFTOP ANTENNAS AND EQUIPMENT, AND OTHER IMPROVEMENTS, EQUIPMENT, FIXTURES AND APPARATUS ON, OVER, ACROSS AND THROUGH PORTIONS OF LOTS 8A, 9A, 12A and 15A OF TRACT NO. 53306, IN THE CITY OF LONG BEACH, COUNTY OF LOS ANGELES, STATE OF CALIFORNIA, AS PER MAP RECORDED IN BOOK 1261, PAGES 31 THROUGH 34 OF MAPS, IN THE OFFICE OF THE COUNTY RECORDER OF SAID COUNTY, AS CREATED BY THAT CERTAIN DECLARATION OF COVENANTS, CONDITIONS AND RESTRICTIONS AND EASEMENTS RECORDED DECEMBER 27, 2001 AS INSTRUMENT NO. 01-2474354.

EXHIBIT A-1

LEGAL DESCRIPTION (continued)

PARCEL 5:

NON-EXCLUSIVE EASEMENTS IN, TO OVER, UNDER AND ACROSS PORTIONS OF LOTS 8A, 9A, 12A and 15A OF TRACT NO. 53306, IN THE CITY OF LONG BEACH, COUNTY OF LOS ANGELES, STATE OF CALIFORNIA, AS PER MAP RECORDED IN BOOK 1261, PAGES 31 THROUGH 34 OF MAPS, IN THE OFFICE OF THE COUNTY RECORDER OF SAID COUNTY, FOR THE CONSTRUCTION, REPAIR, MAINTENANCE, RECONSTRUCTION AND/OR RESTORATION, ERECTION AND REMOVAL OF IMPROVEMENTS, AND AWNINGS ATTACHED THERETO TO THE MAXIMUM LATERAL DISTANCE OF FOUR FEET, ON LOTS 8, 9, 12 and 15 OF TRACT NO. 53306, IN THE CITY OF LONG BEACH, COUNTY OF LOS ANGELES, STATE OF CALIFORNIA, AS PER MAP RECORDED IN BOOK 1261, PAGES 31 THROUGH 34 OF MAPS, IN THE OFFICE OF THE COUNTY RECORDER OF SAID COUNTY, AS CREATED BY THE DECLARATION OF COVENANTS, CONDITIONS AND RESTRICTIONS AND EASEMENTS RECORDED IN THE OFFICIAL RECORDS ON DECEMBER 27, 2001 AS INSTRUMENT NO. 01-2474354.

PARCEL 6:

EXCLUSIVE EASEMENTS FOR THE IMPROVEMENTS ON LOTS 8, 9, 12, AND 15 OF TRACT NO. 53306, IN THE CITY OF LONG BEACH, COUNTY OF LOS ANGELES, STATE OF CALIFORNIA, AS PER MAP RECORDED IN BOOK 1261, PAGES 31 THROUGH 34 OF MAPS, IN THE OFFICE OF THE COUNTY RECORDER OF SAID COUNTY, TO ENCROACH INTO AND ATTACH TO THE IMPROVEMENTS ON LOTS 8A, 9A, 12A and 15A OF TRACT NO. 53306, IN THE CITY OF LONG BEACH, COUNTY OF LOS ANGELES, STATE OF CALIFORNIA, AS PER MAP RECORDED IN BOOK 1261 PAGES 31 THROUGH 34 OF MAPS, IN THE OFFICE OF THE COUNTY RECORDER OF SAID COUNTY, AS CREATED BY THE DECLARATION OF COVENANTS, CONDITIONS AND RESTRICTIONS AND EASEMENTS RECORDED IN THE OFFICIAL RECORDS ON DECEMBER 27, 2001 AS INSTRUMENT NO. 01-2474354.

Assessor's Parcel Numbers:

7280-005-25
7280-005-26
7280-005-51
7280-005-52
7280-005-54
7280-005-56
7280-005-58
7280-005-60

EXHIBIT C
CITY PLACE, LONG BEACH, CALIFORNIA
CONSTRUCTION OF PREMISES PROVISION

PREFACE:

This Exhibit C describes the obligations of Landlord and Tenant for the design and construction of the Premises. Each term used in this Exhibit which is defined in the main body of the Lease shall have the same meaning when used herein.

"Laws" shall mean all applicable laws, statutes, rules, regulations, orders, decrees and ordinances of the City of Long Beach, Los Angeles County, the State of California and the federal government, including any department or agency thereof. Tenant and its contractor(s) will abide by Article XXIII Section W of the Lease. Compliance of all design materials and construction concerning Tenant's Work with all Laws is the sole responsibility of Tenant. Landlord review or approval does not constitute any assurance that Laws have been complied with. Laws may impose different or stricter requirements than Landlord or this Lease, and Tenant must comply with all of the requirements of this Lease, Landlord's approvals and conditions in compliance with this Lease, and all Laws. If Laws change after the date of this Lease or Tenant's construction, Tenant shall be responsible for compliance with all required changes within the scope of Tenant's Work, regardless of whether such work was initially performed by Tenant or by Landlord.

Tenant is responsible for field verification of dimensions and other information provided by Landlord or Landlord's consultants or contractors concerning the Premises, to verify the as-built condition, and to verify that Tenant's final Working Drawings conform to field conditions. If Tenant fails to inspect or incompletely inspects the Premises, Tenant will be charged with such knowledge as a full inspection would reveal. Landlord shall have reasonable access to the Premises at normal construction hours for the purposes of inspection of Tenant's Work. Landlord review does not constitute any assurance of the adequacy, technical sufficiency, safety, application of or compliance with appropriate engineering or construction practices, or any other matter concerning information submitted to Landlord, all of which is the sole responsibility of Tenant. Landlord does not warrant that construction by other tenants conforms to this exhibit.

SECTION 1: LANDLORD'S WORK

Except as herein provided, the Premises are leased to Tenant on as "As-Is" basis. "Landlord's Work" as used in this Lease, shall mean the work specified on Schedule 1 attached to this Exhibit C. Landlord shall not be obligated to perform any work or provide any facilities in relation to the Premises or the Shopping Center except as specified on Schedule 1 attached to this Exhibit C, or as otherwise specifically set forth in this Lease. Where two (2) types of materials or structures are indicated, Landlord will have the option of using either.

SECTION 2: TENANT'S WORK

"Tenant's Work", as used in this Lease, shall mean all work, other than Landlord's Work, which shall be necessary to complete the Premises to a finished condition from which business can be conducted. Tenant acknowledges receipt of the Tenant Design Criteria for City Place ("Tenant Criteria") and agrees

to abide by it; provided, however, that Landlord's approval of the construction drawings shall supercede any requirements to comply with the Tenant Criteria as long as Landlord has been informed, prior to its approval, of any variances between the construction drawings and the Tenant Criteria. Landlord shall make available to Tenant complete plans of the Building of which the Premises are a part at the property management office. Any reproductions of the Building Plans shall be done at Tenant's expense. All of Tenant's Work shall be performed in accordance with the provisions of the "Final Plans" (defined in Section 4(c) below) for Tenant's Work. Tenant shall perform or cause to be performed Tenant's Work at Tenant's expense; provided, however, that Landlord shall enter into a written contract that complies with the requirements of this Lease and this Exhibit C to perform Tenant's Work ("Tenant Work Contract") with a contractor selected by Tenant ("Tenant's Contractor"). Such contract shall comply with Section 1720 of the California Labor Code regarding the payment of prevailing wages. Landlord shall not be responsible for reviewing the contractor bids, the terms of the Tenant Work Contract, particularly related to the scope of services or required payment amounts, oversight of any Tenant Improvements or project management. Tenant has selected Heery International ("Tenant's Representative") to be its representative and to provide architectural and construction management services. Landlord shall be obligated to pay Tenant's Contractor for work performed; provided, however, that Tenant shall reimburse Landlord for all costs and expenses incurred under such contract which exceed the Allowance provided for below at least three (3) business days prior to each payment required to be made by Landlord to Tenant's Contractor or Tenant's Representative ("Tenant's Reimbursement Payments") and upon receipt by Tenant of an invoice therefore. Tenant or Tenant's Representative shall provide Landlord with a complete payment package including lien releases prior to requiring Landlord to make a payment. All references herein to "Tenant's Contractor" shall mean the contractor which executed the construction contract with Landlord, it being the intention of the parties to this Lease that Landlord execute the construction contract but that Tenant act as Landlord's construction manager and agent under such contract and be responsible for all obligations of Landlord in any way related to such contract or the construction. Tenant shall indemnify Landlord from all costs that may arise from the Tenant Work Contract including, but not limited to, any time, expense or penalty related to a Prevailing Wage Audit, any liens filed against the Shopping Center or the Premises or costs associated with removing said liens.

Tenant will, promptly upon Lease execution and thereafter from time to time as Tenant engages such entities, provide this Exhibit C and the Tenant Criteria to Tenant's design consultants and construction contractors, managers and consultants.

All work by Tenant in the Premises under any provision of the Lease will be performed by a general contractor and major subcontractors selected by Tenant and approved in advance by Landlord. Tenant's contractor and subcontractors shall confine their work area and construction presence to the Premises.

Signage will be designed and installed in accordance with the Tenant Criteria and the Final Plans as approved in writing by Landlord and the requirements of Laws.

Tenant must directly arrange for and procure at Tenant's expense all state and local building, plumbing, electrical, sign and occupancy permits required in connection with the construction of the Premises. All construction must conform to all Laws. Landlord believes that, without warranty or limitation, the following codes *may be* applicable:

- (i) 1997 California Building Code
- (ii) 1997 Uniform Mechanical Code
- (iii) 1997 Uniform Plumbing Code
- (iv) 1997 California Fire Code
- (v) 1997 National Electrical Code

- (vi) Americans with Disabilities Act (ADA), ANSI A117.1
- (vii) California Administrative Code Title 24
- (viii) For detailed code information, see Fire Protection and Life Safety Analysis report by Code Consultants, Inc. Dated October 28, 1999

Tenant's Work shall include, but not be limited to, the following and such other items as are specified as Tenant's Work in the Tenant Criteria:

(a). Floor:

Tenant shall provide all floor coverings in the Premises. Concentrated dead loads are not allowed without specific prior written approval of Landlord. No penetrations into or through any shell building walls, floors and/or structural grade beams shall be made without Landlord's prior written approval. All floor slab and shell building wall reinstatement work must be performed by Tenant in strict accordance with Landlord's specifications.

(b). Ceiling and Lighting:

Notwithstanding any contrary provision of Schedule 1 to this Exhibit C, Tenant shall provide all ceiling and lighting work in the Premises. Tenant shall provide any necessary catwalks or access panels in accordance with the Tenant Criteria. Penetration through and/or attachments to roof structure and/or deck above must have prior written approval from Landlord and comply with all of Landlord's roof specifications and installation procedures.

(c). Walls:

Tenant shall provide fire rated drywall on all stud framed demising and perimeter partitions from the finish floor slab to the underside of the roof structure and/or deck above, sealed tight. Tenant is to provide all interior partitions and wall covering in the Premises pursuant to the Tenant Criteria.

(d). Electrical:

Tenant shall provide all electrical work, equipment, fixtures and services for the Premises. Tenant shall provide all temporary power for construction of Tenant's Work at Tenant's expense. All electrical work, including without limitation Tenant's lighting fixtures, lamps, emergency lighting, communication systems, burglar alarms, sign and logo lighting and television and radio systems shall conform to the following criteria:

- (1) The requirements of Laws and the National Electric Code.
- (2) All fluorescent lighting shall have high power factor ballasts.
- (3) No appurtenances shall be affixed to the exterior wall or interior or exterior of the roof of Landlord's building without Landlord's prior written approval.
- (4) Sign (exterior and interior), logo and show window illumination shall be controlled by a time clock.
- (5) Installation of background music systems shall require Landlord's prior written approval and such music shall not be audible outside the Premises.

(e). HVAC:

Tenant shall distribute HVAC within the Premises. All distribution, including duct work, electrical, thermostatic control, life safety system wiring and piping, shall be within the Premises. All construction and engineering costs shall be at Tenant's expense. Any rooftop penetrations and roof repairs required shall be made using Landlord's designated subcontractor and complying with all of Landlord's roof specifications.

(f). Plumbing:

Tenant shall provide all plumbing for the Premises. Tenant shall perform all concrete slab reinstatement work pursuant to Landlord's specifications. Tenant shall make all necessary plumbing vent connections to Landlord's common vent line within the Premises. No penetrations of the foundation shall be made for plumbing lines without Landlord's prior written approval. All penetrations of the second (2nd) floor shall be sealed in a watertight manner.

(g). Gas:

Tenant shall be responsible for distribution within the Premises from the stub-in location nearest the Premises and application for service from the applicable utility company.

(h). Telephone/CATV:

Tenant shall provide all telephone and CATV equipment for the Premises and connections to the main panel board.

(i). Automatic Fire Sprinklers:

Tenant shall make any additions or changes to the sprinkler system provided by Landlord necessary to meet the minimum criteria of governmental or insurance standards. Tenant shall use Landlord's designated contractor for this work.

(j). Signs:

Tenant shall provide signs in accordance with the sign criteria set forth in Tenant Criteria.

(k). Service/Fire Exit Doors:

If required by applicable codes (including code requirements and/or changes or additions to Landlord's Work triggered by Tenant's use or exiting requirements, or Tenant's interior floor plan layout), Tenant shall provide additional service doors and/or fire exit doors which conform with Landlord's requirements and state and local codes. Tenant acknowledges that the rear access corridor is not meant to be handicap accessible or available to the general public. Handicap accessibility to the Premises is through the storefront doors facing Pine Avenue.

(l). Code Related Items:

Tenant shall be responsible for complying with any code requirements applicable to its type of business or its operation in the Premises including code requirements and/or changes or additions to Landlord's Work triggered by Tenant's use or exiting requirements or Tenant's interior floor plan layout.

(m). Fire Alarm System:

Tenant shall be responsible for fire alarm monitoring, including the installation of designated phone lines and monitoring equipment and the hiring of a monitoring company, as required by Landlord, Landlord's designated fire alarm contractor and state and local codes.

(n). Sound Vibration Mitigation:

If, in Landlord's discretion, Tenant's use is anticipated to generate sound and/or vibration beyond that which is typical for normal retail occupancies, then Tenant shall be required to provide an acoustic study for Landlord's review and approval and to install sound and vibration attenuation measures as part of Tenant's Work in a manner consistent with such approved acoustic study to mitigate sound and/or vibration transmission to other premises or the Project Common Area.

SECTION 3: TENANT IMPROVEMENT ALLOWANCE

(a) Allowance:

Tenant shall be entitled to a one time allowance ("Allowance") in an amount equal to **Thirty two thousand Dollars (\$32,000.00), or Ten Dollars and 07 cents (\$10.07)** per square foot of gross leasable area of the Premises, for the costs relate to the initial design, construction and installation of Tenant's Work. The Allowance will be payable by Landlord to Tenant, Tenant's Contractor or Tenant's Representative. In no event shall Landlord be obligated to make disbursements pursuant to the Construction of Premises Provisions in a total amount which exceeds the Allowance plus Tenant Reimbursement Payments.

Except as otherwise set forth in these Construction of Premises Provisions, the total amount of the construction contract with Tenant's Contractor shall be disbursed by Landlord only for the following items and costs (collectively the "Construction Items"):

- (i) Payment of the fees incurred by, and the cost of documents and materials supplied by, Tenant and Tenant's consultants in connection with the preparation of the "Preliminary Drawings" and the "Final Working Drawings, as hereinafter defined (and sometimes collectively referred to as the "Drawings");
- (ii) The payment of plan check, permit and license fees relating to construction and installation of Tenant's Work;
- (iii) The cost of construction and installation of Tenant's Work, including, without limitation, testing and inspection costs, hoisting and trash removal costs, and contractors' fees and general conditions;
- (iv) The cost of any changes to the Premises when such changes are required by the Drawings, such cost to include all direct architectural and/or engineering fees and expenses incurred in connection therewith;
- (v) The cost of any changes to the Drawings or Tenant's Work required by applicable code;
- (vi) Sales and use taxes and Title 24 fees; and;

- (vii) All other costs to be expended by Landlord or Tenant in connection with the design, construction or installation of Tenant's Work including installing voice/data cabling or modular furniture.
- (viii) In no event shall the Construction Items include any costs incurred by Tenant for furniture, equipment, trade fixtures or personal property of Tenant other than those items permitted above in item Section 3 (a)(i-vii). All Construction Items for which the Allowance or other monies have been made available shall be deemed Landlord's property under the terms of Article 11 of the Lease.

(b) Disbursement of the Allowance and other Contract Monies:

Upon completion of all or any portion of the Tenant improvements for which Landlord is requested to pay, Landlord shall have received from Tenant's Representative all approved invoices, final contracts, any other agreements relating to such improvements and unconditional lien releases for such work Landlord is then expected to make payment for. Provided that Landlord has received funds from Tenant within eighteen (18) days following receipt of an approved payment package, within twenty-one (21) days following delivery and approval of such information, Landlord shall make disbursements directly to the contractor or vendor entitled to receive such payment. Landlord shall reserve disbursement of the Allowance for retention and final payments to Tenant's Contractor, Tenant's Representative and/or their vendors.

Commencing on the date that Tenant satisfies all of the following conditions, Landlord shall make payment of the Allowance by way of check(s) of up to the maximum amount of the Allowance. Prior to payment of the first installment of the Allowance, all of the following conditions shall be satisfied:

- (i) Construction and installation of Tenant's Work shall be complete;
- (ii) Tenant has delivered to Landlord copies of properly executed final mechanic's lien releases in compliance with California law from all contractors and subcontractors that were engaged in performing Tenant's Work; whether such work shall be reimbursed by the Allowance or is in excess of the Allowance;
- (iii) Landlord has determined that no substandard work exists;
- (iv) Tenant's Architect delivers to Landlord a certificate, in a form reasonably acceptable to Landlord, certifying that the construction is complete and installation of Tenant's Work has been substantially completed; and
- (v) Tenant has provided Landlord with a copy of the Certificate of Occupancy for the Premises issued by the City of Long Beach.

SECTION 4: DESIGN APPROVAL PROCEDURE

(a) Selection of Tenant's Architect; Preparation of Preliminary Drawings:

- (i) Tenant's Architect shall prepare "Design Build" construction documents indicating voice/data power locations and requirements; reflected ceiling layout, light fixture type and location; plumbing fixture type and location and HVAC requirements. These documents will be issued to the Tenant's General Contractor and mechanical, electrical and plumbing sub-contractors for mechanical, engineering and plumbing design to the applicable building code and issue to the local agency for plan check review and permit. Tenant represents that all construction drawings, plans and engineering working drawings relating to the structural, mechanical, electrical, plumbing, HVAC, life safety, and sprinkler work shall be completed by qualified contractors and engineers.

- (ii) Prior to preparing any drawings Tenant shall participate in a kickoff/coordination meeting to discuss any special conditions that may affect the design of the Premises and to review the Tenant Criteria. In addition, Tenant's Architect shall be required to field inspect the condition on-site at and about the Premises prior to submittal of the "Preliminary Drawings" (as hereinafter defined).
- (iii) Within fifteen (15) days of Delivery of Possession of the Premises, Tenant shall submit to Landlord's representative three (3) sets of blue line prints and one (1) set of reproducible prints showing intended design character and finishes of the Premises ("Preliminary Drawings").
- (iv) Preliminary Drawings shall include the following:
 1. Key plan showing location of the Premises within the Shopping Center
 2. Preliminary floor and reflected ceiling plans (Scale 1/4" = 1') indicating interior design concept.
 3. Typical interior elevations (Scale 1/4" = 1')
 4. Storefront elevation and section, including any graphics, lighting and signage and indicating all materials and finishes (Scale 1/4" = 1'). Elevations shall be rendered in color. Elevations should include existing context (i.e. partial elevations of retail spaces) and should be drawn full height to top of building.
 5. Preliminary finish schedule including all colors and materials to be used.
 6. Preliminary utility service load estimates (electrical, HVAC tonnage, gas and water) if Tenant anticipates that its load requirements are going to be in excess of Landlord's specified utility services pursuant to these Construction of Premises Provisions.
 7. All exterior signage is considered integral to the design and is required to be submitted with preliminary elevations.
- (v) Within a reasonable period after receipt of Preliminary Drawings, Landlord's representative will return to Tenant's Architect one (1) set of prints of the Preliminary Drawings with any required modifications or with approval. If Tenant wishes to take exception to any required modifications, Tenant may do so only by written notice received by Landlord within ten (10) days from the date of receipt by Tenant's Architect of the required modifications. Unless exception is so taken, it will be deemed that all comments are acceptable to and approved by Tenant.
- (vi) If the Preliminary Drawings are returned to Tenant with required modifications and Tenant does not take (or is deemed not to have taken) exception to such modifications as provided above, the Preliminary Drawings must be revised and resubmitted to Landlord for approval within fifteen (15) days of their receipt by Tenant's Architect.
- (vii) If Tenant properly takes exception to any required modifications as provided above, Landlord will discuss the objections with Tenant and will work with Tenant to achieve Final Working Drawings that are acceptable to Landlord. If Tenant and Landlord are unable to agree on Preliminary Drawings, Landlord may terminate this Lease.
- (viii) If the Preliminary Drawings are returned "Approved as Noted" and Tenant does not take exception, Tenant's Architect shall incorporate Landlord's modification into the Final Working Drawings.

(b) Final Working Drawings:

- (i) Tenant's Architect shall prepare the Final Working Drawings, which shall adhere to the Preliminary Drawings as approved by Landlord.
- (ii) Final Working Drawings shall be prepared in a CADD reproducible format and shall include, but not be limited to, the following:

1. Key plan showing location of the Premises within the Shopping Center.
 2. Floor plans (Scale $\frac{1}{4}'' = 1'$) indicating storefront construction material, colors and finishes as well as sliding door track location (if required), location of partitions and type of construction, placement of merchandising fixtures and toilet room locations indicating placement of plumbing and fixtures.
 3. Reflected ceiling plans (Scale $\frac{1}{4}'' = 1'$) indicating ceiling materials, various heights, location of all light fixtures, their manufacturer's name and catalog number, lamps to be used and mounting (recessed, surface, etc.), location of sprinkler heads and HVAC grilles.
 4. Storefront elevation and section, including any graphics, lighting and signage. Indicate all materials and finishes (Scale $\frac{1}{4}'' = 1'$).
 5. Interior elevations, sections and details sufficient for construction (Scale $\frac{1}{4}'' = 1'$).
 6. Complete interior finish schedule.
 7. Samples and color chips of the actual materials or charts firmly attached to illustration boards and clearly labeled.
 8. Sign details (Scale $1\text{-}1/2'' = 1'$) indicating elevation and section views, letter style and size, all colors and materials, methods of illustration, color of illuminate and voltage requirements.
 9. Mechanical drawings, including electrical, HVAC, plumbing and automatic fire sprinklers prepared by any of Tenant's Engineers.
 10. Electrical and/or mechanical drawings must indicate total connected electrical loads and panel schedules, AC cooling requirement, water service capacity requirements and natural gas service requirements (if needed). Mechanical plans must indicate the operating weights and location of any additional Tenant provided rooftop mechanical equipment.
 11. Specifications not shown on drawings should be submitted on $8\text{ }1/2'' \times 11''$ paper, four sets.
 12. Landlord reserves the right to require mock-ups of any materials, finishes, colors, special signs or lighting.
- (iii) The Final Working Drawings must be submitted to Landlord's representative in the form of three (3) sets of black or blue line prints and one (1) set of reproducible prints within fifteen (15) days from the earlier of delivery to Tenant's Architect or Landlord's approval of the Preliminary Drawings. Final Working Drawings with incomplete or inadequate information or dimensional discrepancies will be rejected.
- (iv) Within a reasonable period after receipt of Final Working Drawings, Landlord's representative will return to Tenant's Architect one (1) set of prints of the Final Working Drawings with any required modifications or with approval. If Tenant wishes to take exception to any required modifications, Tenant may do so only by written notice received by Landlord within seven (7) days from the date of receipt by Tenant's Architect of the required modifications. Unless exception is so taken, it will be deemed that all comments are acceptable to and approved by Tenant.
- (v) If the Final Working Drawings are returned to Tenant with comments and Tenant does not take (or is deemed not to have taken) exception to such modifications as provided above, the Final Working Drawings must be revised and resubmitted to Landlord for approval within seven (7) days of their receipt by Tenant's Architect.
- (vi) If Tenant properly takes exception to any required modifications as provided above, Landlord will discuss the objections with Tenant and will work with Tenant to achieve Final Working Drawings that are acceptable to Landlord. If Tenant and Landlord are unable to agree on Final Working Drawings, Landlord may terminate this Lease.

(vii) Approved Final Working Drawings will be so stamped and returned to Tenant's Architect who made the submittal.

(c) Final Plans:

The approved Final Working Drawings will be considered the "Final Plans". Tenant agrees to provide to Landlord a complete diskette containing the computer-assisted drawings of the Final Plans. All construction on the Premises must be in conformity to the Final Plans. Tenant's Work may be inspected by Landlord or its architect who shall have the right to require all work, which does not comply with the Final Plans to be corrected by Tenant, or by Landlord, at Tenant's Cost. Construction may not begin until Final Plans are at the job site. No changes, modification or alteration to the Final Plans may be made without the written consent of Landlord.

(d) Failure to Submit Plans:

If Tenant fails to submit Preliminary Drawings or Final Working Drawings or revisions thereto as and when required, the Outside Opening Date set forth in the Lease shall not be affected, except that if Landlord is delayed in the completion of Landlord's Work as a result thereof, then the Outside Opening Date shall be accelerated to the date which the Outside Opening Date would have occurred if Tenant had not delayed the completion of Landlord's Work. In addition, on such a delay by Tenant, Landlord, at its option, may elect to terminate this Lease.

(e) Building Code Compliance and Non-Responsibility of Landlord: Failure to Submit Plans:

Landlord will not check Tenant's drawings for building code compliance. All Tenant drawings shall, however, be subject to the same engineering and safety review as described in Section 5(d) (vi) below respecting Tenant's Work, and such review shall be subject to the limitations and other provisions set forth in Section 5. Approval of Final Working Drawings by Landlord is not a representation that the drawings are in compliance with the requirements of governmental authorities, and it shall be Tenant's responsibility to (i) meet and comply with all Federal, state and local code requirements, (ii) secure issuance of a building permit (and all other necessary permits) required to be obtained in connection with Tenant's Work, and (iii) pay for all fees assessed in connection with the permits obtained by Tenant in connection with Tenant's Work. Approval of Final Working Drawings does not constitute assumption of responsibility by Landlord for their accuracy, sufficiency or efficiency and Tenant shall be totally responsible for such matters. Tenant at all times shall maintain at the Premises the Final Plans as approved by the local governing agencies and Landlord, and all inspection cards with respect to Tenant's Work.

(f) Building Design Fees:

All of Tenant's design fees (including, without limitation, Tenant's Architect and sign designer) must be paid by Tenant.

(g) Changes to Final Plans:

In the event Tenant desires to make any changes to Final Plans, Tenant shall first submit to Landlord drawings (in a form reasonably requested by Landlord) (the "Change Order Drawings") indicating such requested changes. Within fifteen (15) days after receipt of the Change Order Drawings, Landlord's representative will return to Tenant's Architect the Change Order Drawings with any required modifications or with approval. If Tenant wishes to take exception to any required modifications, Tenant may do so only by written notice received by Landlord within ten (10) days from the date of receipt by Tenant's Architect of the required modifications. Unless exception is so taken, it will be deemed that all comments are acceptable to and approved by Tenant. If the Change Order Drawings are returned to Tenant with comments and Tenant does not take (or is deemed not to have taken) exception to such modifications as provided above, the

Change Order Drawings must be revised and resubmitted to Landlord for approval within fifteen (15) days of their receipt by Tenant's Architect. If Landlord is required to submit the Change Order Drawings to its engineer and/or other consultants for review, Tenant shall be responsible to reimburse Landlord for the costs charged to Landlord by such engineer/consultants within thirty (30) days following Tenant's receipt of reasonable evidence of such costs.

SECTION 5: CONSTRUCTION OF PREMISES

(a) General Contractor; Construction Contract; Cost Budget:

- (i) A general contractor ("Tenant's General Contractor") shall be retained by Tenant to construct Tenant's Work pursuant to a written construction contract and general conditions (the "Contract"). Tenant's General Contractor must be approved in writing by Landlord which approval shall not be unreasonably withheld or delayed. Tenant's General Contractor and all subcontractors, laborers, materialmen, and suppliers to be know collectively as "Tenant's Agents".
- (ii) Prior to Tenant's execution of the Contract, Tenant shall submit the Contract to Landlord for its approval, which approval shall not be unreasonably withheld or delayed, provided that the Contract shall provide for assignment to Landlord upon a Construction Progress Default as indicated in Section 8(d) below. Prior to the commencement of the construction of Tenant's Work, and after Tenant has accepted all bids for Tenant's Work, Tenant shall provide Landlord with a detailed breakdown, by trade of the final costs to be incurred or which have been incurred in connection with the design, installation and construction of Tenant' Work, which costs form a basis for the amount of the Contract (the "Final Costs").

(b) Commencement of Construction:

Upon receipt by Tenant of all applicable permits, Tenant shall commence construction of Tenant's Work in accordance with the provisions of this Lease and shall diligently and continuously carry such construction to completion with all due diligence in accordance with the approved Final Plans.

(c) Meetings; Schedule:

Commencing upon the execution of this Lease, Tenant shall hold periodic meetings at a reasonable time and with frequency determined by Landlord, with Tenant's Architect and the Tenant's General Contractor regarding the progress of the preparation of Preliminary and Final Working Drawings and the design, construction and installation of Tenant's Work, which meetings shall be held at a location designated by Landlord, and Landlord and/or its agents shall receive prior notice of, and shall have the right to attend, all such meetings, and, upon Landlord's request, certain of Tenant's Agents shall attend such meetings. One such meeting each month shall include the review of Tenant's General Contractor's current request for payment. Prior to commencement of construction of Tenant's Work, Tenant shall submit to Landlord, for Landlord's approval, a Schedule ("Construction Schedule") for construction of Tenant's Work, which shall contain various milestones mutually agreed upon by Landlord and Tenant, in good faith.

(d) General Requirements:

- (i) Tenant's Agents shall comply with all rules, regulations, and applicable fees as described in the Tenant Criteria.

- (ii) Tenant shall only engage contractors who are bondable, licensed contractors, possessing good labor relations, capable of performing quality workmanship and working in harmony with Landlord and other contractors on the job. All work shall be coordinated with other Shopping Center work.
- (iii) Tenant shall perform or cause to be performed Tenant's Work in all respects with applicable Federal, state, county and city statutes, ordinances, regulations, laws and codes. All required permits, approvals, license, authorizations and other permits in connection with the construction and completion of the Premises including, without limitation, building permits and conditional use permits, shall be obtained and all fees (both one-time and recurring) required in connection with the construction and completion of the Premises shall be paid for by Tenant.
- (iv) Tenant shall apply and pay for all utility services including, but not limited to, temporary utilities.
- (v) Tenant shall cause Tenant's Agents to provide warranties for not less than one (1) year against defects in workmanship, materials and equipment, commencing upon Landlord's acceptance of Tenant's Work.
- (vi) Tenant acknowledges that Tenant's Work shall be subject to (1) the inspection and approval of Landlord for the purpose of determining Tenant's compliance with the Final Plans, and (2) an engineering and safety review by Landlord for the purpose of making an assessment regarding the potential safety impact of Tenant's Work on other portions of the Shopping Center, which review may include, without limitation, the examination of (A) any penetrations through the roof or other structural elements of the Premises, (B) the transition points from the Common Areas to the Premises, and (C) any flooring, common walls or similar surfaces which may constitute a potential for leakage into other portions of the Shopping Center. Any such inspection, approval, or review shall not constitute an approval of architectural or engineering design, a review to determine the structural safety of Tenant's Work or Tenant's compliance with any building codes or other legal requirements, or otherwise constitute any assumption of liability or responsibility by Landlord or its agents or contractors. Tenant hereby expressly acknowledges that no such inspection, approval or review shall in any way limit the obligations of Tenant or the rights of Landlord under this Lease, and, without limitation of the foregoing, Tenant's obligations under that provision in the Lease regarding indemnity of this Lease shall apply to any claims, etc. (as more fully indicated in such indemnity provision) arising or alleged to have arisen in connection with the Premises, Tenant's Work or the safety or structural integrity thereof. Should Landlord disapprove any portion of Tenant's work, Landlord shall notify Tenant in writing of such disapproval and shall specify the items disapproved. Any defects or deviations in, and/or disapproval by Landlord of, Tenant's work shall be rectified by Tenant at its sole cost and expense. If Tenant fails to perform such corrective measures, Landlord may take such action as Landlord deems necessary, at Tenant's expense and without incurring any liability on Landlord's part, to correct any such defect, deviation, and/or matter, including, without limitation, causing the cessation of performance of the construction of Tenant's Work until such time as the defect, deviation and/or matter is corrected to Landlord's satisfaction.
- (vii) Tenant shall be responsible for having a superintendent from Tenant's General Contractor's office on-site during all Tenant's Work and fixturation work. Tenant's General Contractor's superintendent or other responsible representative shall be on the job-site to receive all deliveries of materials, fixtures or merchandise. Landlord reserves the right to turn away any delivery arriving at the job-site if Tenant's General Contractor's superintendent or other responsible representative is not present. Tenant

shall stage its construction equipment and materials only in the staging area designated for such purpose by Landlord.

- (viii) Tenant shall cause Tenant's Agent during the construction of Tenant's Work to maintain the Premises and the job-site in a clean condition and to provide: daily removal, cleanup and proper disposal of all trash, rubbish, refuse and construction debris and spoils generated by Tenant's Agents in dumpsters and other appropriate facilities, and not by depositing any such trash, refuse and construction debris, and spoils within other tenant spaces or the job-site common areas. If Landlord incurs costs to clean up the job-site and/or adjacent tenant spaces due to the failure of Tenants Agents to comply with the foregoing requirements, Tenant agrees to promptly reimburse such costs (or Tenant's proportionate share of such costs, which Landlord shall determine as a flat per-square foot rate based on the Floor Area of the Premises) upon receipt of an invoice reasonably detailing such costs. Tenant shall control and retain noise, dust or other materials with the Premises, subject to directives from Landlord. Tenant shall be required to clean all HVAC filters clogged with dust or other materials caused by its construction activities.
- (ix) Tenant and Tenant's Agents shall be responsible for the daily removal, cleanup and proper disposal of their own rubbish, trash and construction debris, and for providing adequate dumpster(s) for such purpose (to be located in only areas designated by Landlord). Tenant shall contract with a disposal company to provide daily removal of its share of the rubbish, trash and construction debris. If Landlord provides dumpsters for common use, or if Tenant's Agents use Landlord's, Tenant shall pay its proportionate share of the cost of such trash service, including dumpster rental and hauling fees and charges, which Landlord shall determine as a flat per square foot rate based on the gross leasable area of the Premises.
- (x) Tenant shall be responsible for any and all damage done by Tenant's Agents to any of Landlord's buildings, other tenant premises, or the Common Areas. Tenant shall at all times cause Tenant's Agents to comply with the requirements of Landlord's general contractor and/or on-site construction manager with respect to protection of Landlord's construction work in the Shopping Center which has been completed or is in progress, including paths of access within the Shopping Center for construction materials, equipment and labor, and coordination of sequencing of work. Tenant agrees to promptly reimburse Landlord for all costs incurred by Landlord to repair (including re-patching and repainting) any and all damage done by Tenant's Agents to any of Landlord's buildings, other tenant premises, or the Common Areas upon receipt of an invoice reasonably detailing such costs.
- (xi) Tenant's Agents shall provide their own temporary toilets within the Premises or in an area designated by Landlord. Any temporary toilets located by Tenant or Tenant's Agents other than in areas designated by Landlord may be removed at Tenant's expense. Temporary toilets placed on-site by Landlord's general contractor shall not be available for use by Tenant's Agents or other personnel.
- (xii) Tenant shall provide and pay for its own temporary power and telephone service from locations designated by Landlord. Landlord's general contractor's job-site telephones shall not be available for use by Tenant's Agents or other personnel. If Tenant or Tenant's Agents use Landlord's temporary power, Tenant agrees to pay Landlord and/or Landlord's general contractor the actual or reasonable estimated cost of such power, plus a facilities charge equal to twenty-five percent (25%) of the actual or reasonably estimated cost of such power usage.
- (xiii) Tenant and/or Tenant's General Contractor shall be responsible for providing all security deemed necessary by Tenant to protect Tenant's Work, including furniture, fixtures and

inventory, during the conduct of Tenant's Work. Neither Landlord nor Landlord's general contractor shall provide or be responsible for any such security or protection.

- (xiv) To the extent that the cost of Tenant's Work shall exceed Twenty Five Thousand Dollars (\$25,000), Tenant's contractor shall furnish and maintain performance and payment bonds in an amount equal to 125% of the construction contract price and all additions thereto, and all obligations arising in connection therewith. The performance and payment bonds shall name Landlord as obligee and will be in such a form and with such sureties as are reasonably satisfactory to Landlord.

(e) Insurance Requirements:

- (i) All of Tenant's Agents shall carry worker's compensation insurance covering all of their respective employees, and shall also carry public liability insurance, including property damage, all with limits in form and with companies as are required to be carried by Tenant as set forth in Article XII of this Lease.
- (ii) Tenant shall carry "Builders All Risk" insurance in an amount approved by Landlord covering the construction of Tenant's Work and naming Landlord as a loss payee. Such insurance shall be in amounts and shall include such extended coverage endorsements as may be reasonably required by Landlord and in form and with companies as are required to be carried by Tenant as set forth in Article XII of this Lease.
- (iii) Certificates for all insurance carried pursuant to this Section 5(e) shall be delivered to Landlord before the commencement of construction of Tenant's Work and before any equipment of Tenant's Agents is moved onto the site. All such policies of insurance must contain a provision that the company writing said policy will give Landlord thirty (30) days prior written notice of any cancellation or lapse of the effective date or any reduction in the amounts of such insurance. In the event that any of Tenant's Work is damaged by any cause during the course of the construction thereof, Tenant shall immediately repair the same at Tenant's sole cost and expense. Tenant shall request that Tenant's agents and contractors maintain Products and Completed Operation Coverage for eight (8) years following completion of the work and acceptance by Tenant and Landlord. All policies carried under this Section 5(e) shall insure Landlord and Tenant, as their interest may appear, as well as Tenant's Agents. All insurance, except Workers Compensation, maintained by Tenant's Agents shall preclude subrogation claims by the insurer against anyone insured thereunder. Such insurance shall provide that it is primary insurance as respects the owner and that any other insurance maintained by owner is excess and non-contributing with the insurance required hereunder. The requirements for the foregoing insurance shall not derogate from the provisions for indemnification of Landlord by Tenant under Section 5(d) (vi) of these Construction of Premises Provisions.

Subject to limitations contained in Section 2782 of the California Civil Code that prohibit the Landlord from being indemnified from its sole negligence or wilfull misconduct, Tenant agrees to indemnify, defend and hold harmless Landlord, its partners, parent corporations, any ground lessor and their officers, agents and employees from and against all claims, liabilities, losses, damages and expenses of whatever nature including those to the person and property of Tenant, its employees agents, invitees, licensees and others arising out of or in conjunction with the performance of Tenant's Work except to the extent the same may arise out of Landlord's, any ground lessor's or their agents' or employees' negligence, it being understood that the foregoing indemnity shall be in addition to the insurance requirements set forth above and shall not be in discharge of or in substitution for same.

(f) **Landlord's Right to Perform Work:**

Landlord shall have the right, but not the obligation, to perform on behalf of and for the account of Tenant, subject to reimbursement of the cost thereof by Tenant, any and all of Tenant's Work which Landlord determines, in its sole discretion, should be performed immediately and on an emergency basis, for the best interest of the Shopping Center, including, without limitation, work which pertains to structural components, technical, sprinkler and general utility systems, fire alarm systems, roofing and removal of unduly accumulated construction materials and debris.

(g) **Notice of Completion; Copy of Record Set of Plans:**

Within ten (10) days after completion of construction of Tenant's Work, Tenant shall cause a Notice of Completion to be recorded in accordance with California law, and shall furnish a copy thereof to Landlord upon such recordation. If Tenant fails to do so, Landlord may execute and file the same on behalf of Tenant as Tenant's agent for such purpose, at Tenant's sole cost and expense. At the conclusion of construction, (i) Tenant shall cause Tenant's Architect and Tenant's General Contractor (A) to update the Final Plans as necessary to reflect all changes made to the Final Plans during the course of construction, (B) to certify to the best of their knowledge that the "record-set" of as-built drawings is true and correct, which certification shall survive the expiration or termination of this Lease, and (C) to deliver to Landlord one (1) reproducible set and CADD diskette of such record set of drawings within ninety (90) days following issuance of a certificate of occupancy for the Premises, and (ii) Tenant shall deliver to Landlord a copy of all warranties, guaranties, and operating manuals and information relating to Tenant's Work, equipment and systems in the Premises.

SECTION 6: ALTERATIONS

Unless otherwise provided in the Lease, Tenant shall not perform any alterations to the Premises without the prior written approval of Landlord, which shall not unreasonably be withheld. In requesting Landlord's approval of such alterations, Tenant shall follow the procedures set forth in Section 4 above; provided, however, the initial date for delivery of the Preliminary Drawings for such alterations shall be thirty (30) days prior to the date Tenant desires to commence such alterations. The Preliminary Drawings and the Final Working Drawings shall consist of the appropriate drawings in relation to the intended alterations.

SECTION 7: LIENS

In the event that as a result of any work of improvement undertaken by Tenant or under Tenant's Contract executed by Landlord, any mechanic's lien or other lien is filed against the Premises, Tenant shall immediately cause such lien to be removed of record by either paying the amount of the lien or procuring and recording a statutory lien release bond in an amount equal to one hundred fifty percent (150%) of the amount of said lien. If Tenant fails to remove such lien and such failure continues for twenty (20) days after written demand by Landlord to do so, Landlord shall have the right, but not the obligation, in addition to all other rights and remedies available to Landlord under this Lease, to procure and cause to be recorded a statutory lien release bond and to collect from Tenant as Additional Rental (i) all cost incurred in procuring such bond, and (ii) the sum of One Hundred Dollars (\$100.00) as reimbursement for all recording and processing fees and administrative costs and expenses incurred by Landlord in procuring and causing such bond to be recorded.

SECTION 8: MISCELLANEOUS

(a) Tenant's Representative:

Tenant has designated **Heery International, Inc.** as its sole representative with respect to the matters set forth in these Construction of Premises Provisions, which shall have full authority and responsibility to act on behalf of the Tenant as required in these Construction of Premises Provisions. Tenant may designate a substitute representative at any time upon notice to Landlord.

(b) Landlord's Representative:

Landlord has designated **Janice Scheurman of Hill Management** as its sole representative with respect to the matters set forth in these Construction of Premises Provisions who shall have full authority and responsibility to act on behalf of the Landlord as required in these Construction of Premises Provisions. Landlord may designate a substitute representative at any time upon notice to Tenant.

(c) Time is of the Essence in these Construction of Premises Provisions:

Unless otherwise indicated, all references herein to a "number of days" shall mean and refer to calendar days. If any item requiring approval is timely disapproved by Landlord, the procedure for preparation of the document and approval thereof shall be repeated until the document is approved by Landlord.

(d) Tenant's Default:

Notwithstanding any provision to the contrary contained in this Lease, if an event of default as described in this Lease or these Construction of Premises Provisions has occurred at any time on or before the substantial completion of Tenant's Work, then (i) in addition to all of the rights and remedies granted to Landlord pursuant to this Lease, Landlord may cause Tenant's Agents to cease the construction of the Premises (in which case, Tenant shall be responsible for any delay in the substantial completion of Tenant's Work caused by such work stoppage), and (ii) all other obligations of Landlord under the terms of these Construction of Premises Provisions shall be forgiven until such time as such default is cured pursuant to the terms of this Lease (in which case, Tenant shall be responsible for any delay in the substantial completion of Tenant's Work caused by such inaction by Landlord).

If Landlord determines, in good faith, that (a) construction of Tenant's Work is behind the Construction Schedule, and such construction is not rescheduled in a manner acceptable to Landlord within ten (10) days after Landlord's written notice to Tenant of said determination, or (b) Tenant's Work have not been completed on or before the Outside Opening Date specified in this Lease, Tenant shall be deemed to have committed a "Construction Progress Default." In the event of a Construction Progress Default, Landlord shall have the right, but not the obligation, to assume responsibility for the construction of Tenant's Work by taking an assignment of Tenant's contracts with Tenant's Architect, any of Tenant's Engineers, and Tenant's General Contractor. If Landlord exercises said right, Tenant shall execute such documents and/or assign such rights and obligations as may be requested by Landlord in order to complete construction of Tenant's Work; provided, however that Tenant shall continue to be liable for all obligations under such contracts including, without limitation, the payment of any amounts to Tenant's Architect, Tenant's Engineers and/or Tenant's General Contractor thereunder. Tenant's contracts with Tenant's Architect, Tenant's Engineers and Tenant's General Contractor shall contain such provisions acceptable to Landlord providing for such assignment in the case of a Construction Progress Default.

(e) Sprinkler System Shutdown:

Drain down and recharge of sprinkler system will be controlled by Landlord. Tenant shall give Landlord at least three (3) days' prior written notice of any requested shutdown. Tenant shall reimburse Landlord Two Hundred Fifty and 00/100 Dollars (\$250.00) per drain down.

(f) Violations of Laws:

In the event Tenant is notified of any violations of Laws, either by governmental authorities or by Landlord, Tenant shall, at its expense, correct such violations within such ten (10) calendar days after such notification (or such lesser time as may be required by Laws; immediately, if potential damage to persons or property is involved). Should Tenant fail to correct such violations within such time, Landlord may elect in its sole discretion, but under no circumstances shall be obligated, to correct such violations and Tenant shall reimburse Landlord for the actual cost of the work plus fifteen percent (15%) thereof for administration costs.

SCHEDULE 1 TO EXHIBIT C

LANDLORD'S WORK

CITY PLACE LONG BEACH

Landlord is delivering the Leased Premises in "As-Is" raw shell condition described below. If the existing conditions do not meet the described conditions below, Landlord is under no obligation to provide the missing items.

Floor

"As-Is". Unsealed concrete slab. Estimated load capacity 100 PSF with utility cleanouts.

Clear Height

"As-Is". Approximately ten (10) foot clear above concrete slab on grade. Tenant to verify.

Ceiling

"As-Is". Open ceiling with exposed structural members and Mechanical, Plumbing and Electrical utilities as described below. No insulation.

Walls

"As-Is". Demising walls shall be constructed of metal studs only, from floor slab to the underside of the roof structure above. Landlord may supply unfinished masonry wall in lieu of metal studs at Landlord's option.

Storefront

"As-Is". Existing storefront system with two separate single front doors with 1/4" thick clear tempered glass and closer hardware.

Restrooms

None provided by Landlord.

Egress Door(s)/2nd Exit

One exit door to rear hallway. If required by code, additional exit doors to be provided by Tenant's Work. Tenant acknowledges that the rear access corridor is not meant to be handicap accessible or available to the general public but will be available in the event of an emergency. Handicap accessibility to the Premises is through the storefront doors facing Pine Avenue.

Electrical

"As-Is". At central electric service distribution point in building, an empty meter base and fusible disconnect (120/208V, 3 phase, 4 wire) sized to provide 20 watts/leasable square footage – one (1) conduit only (main service conduit) sized to accommodate copper conductors to provide 20 watts per leasable square footage with pull string from distribution point to Premises. Conduit may be overhead or under slab at discretion of Landlord. Tenant responsible for pulling line and all electrical distribution.

HVAC

"In good condition". Landlord believes there are roof mounted HVAC units installed with duct plenum stubbed to Premises. Tenant to verify. All distribution ductwork, electric service, thermostat, condensate, drain piping, and drain receptor by Tenant. Roof penetration by Landlord. No additional HVAC units to be provided by Landlord.

Plumbing

“As-Is”. Concrete slab clean-out and under-slab 4” sewer line. One (1) roof penetration with roof jack provided by Landlord for waste vent piping by Tenant. One (1) minimum 1” overhead water service stubbed to Premises. Condensate drain piping from roof-mounted HVAC units with roof penetration stubbed into Premises.

Gas

“As-Is”. Landlord to provide gas service distribution manifold at centralized location in building. Access for gas distribution piping to be provided by Landlord with all piping to be provided by Tenant. Final location of gas piping runs subject to Landlord approval.

Telephone/CATV

“As-Is”. Landlord to provide one (1) empty conduit with pull string from MPOE in centrally located telephone room to Premises. Tenant responsible to pull line.

Grease Interceptor

“As-Is”. If required by Tenant’s use, Tenant to provide.

Fire Alarm System

“As-Is”. Landlord to provide fully automatic sensing and annunciation system per code to service building shell only (not the Premises). Tenant responsible for Fire Alarm System within the Premises. Tenant’s system will not be able to connect in with the central system.

Fire Sprinklers

“As-Is”. Landlord to provide overhead main with heads facing upward to protect shell structure per code. Tenant to provide drops and finished heads.

Roofing

All roof work and repairs necessitated by Tenant’s construction shall be performed by Landlord’s contractor at Tenant’s expense.

Signage

“As-Is”. Space allocation only. Tenant to provide J Box with conduit with installation of signage. Signage to be furnished and installed by Tenant in accordance with Sign Criteria for CityPlace which must be approved by Landlord prior to submission to the City of Long Beach.

EXHIBIT D

TENANT DESIGN CRITERIA

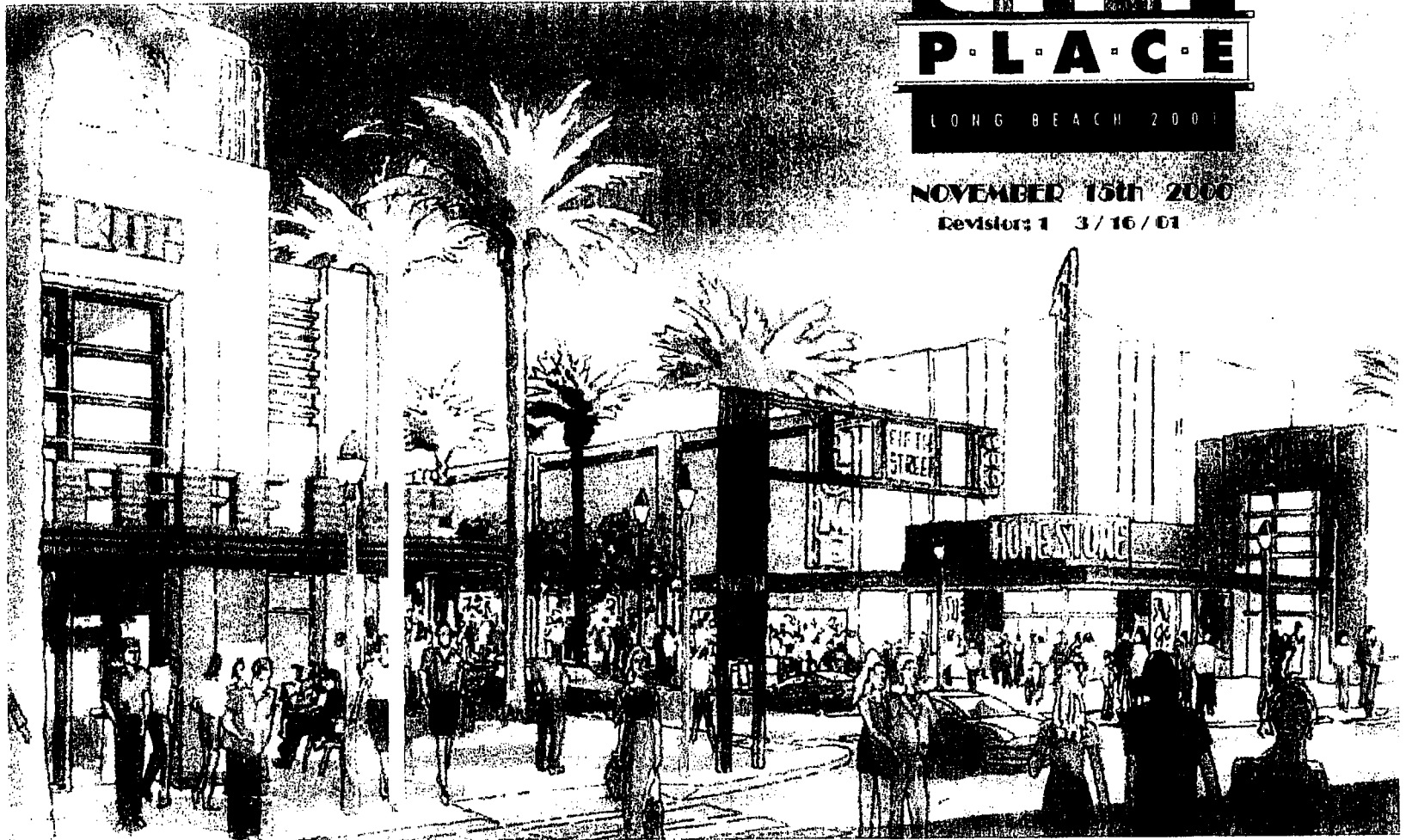

**CITY
PLACE**
LONG BEACH 2000

NOVEMBER 16th 2000
Revisor: 1 3/16/01

SIGN CRITERIA



T A B L E O F C O N T E N T S

OBJECTIVE	1
OVERVIEW AND MAINTENANCE	2
PRIMARY TENANT IDENTIFICATION	3
PROJECTING SIGNS	4
BLADE SIGNS	5
SIGN STYLES	6
TYPE STYLES AND LOGOS	7
LIGHTING	8
APPROVALS	9
FABRICATION AND INSTALLATION	10
PROHIBITED SIGNS	11
SITE PLAN	12
ITEM 1 PROJECT PYLON AND DIRECTORY ID	13
ITEM 2 VEHICULAR DIRECTIONALS	14
ITEM 3 PARKING ENTRY ID	15
ITEM 4 TENANT PYLON (NO PROJECT ID)	16

O B J E C T I V E

The objective of the sign design guidelines is to provide standards and specifications that assure consistent quality, size variety and placement for Tenant signs throughout this project. The guidelines are intended to stimulate creative invention and achieve the highest standard of excellence in environmental graphic communication. Such excellence can best be achieved through open and frequent dialogue between Tenant, Landlord, and the project's graphic design consultant. Signing at City Place, Long Beach California is an integral part of the center's image and appeal, so signs must be carefully placed and proportioned to the individual architectural façade on which they are placed. Care in the design and installation of store signs will enhance customer's appreciation of individual tenants and contribute to the projects overall success.

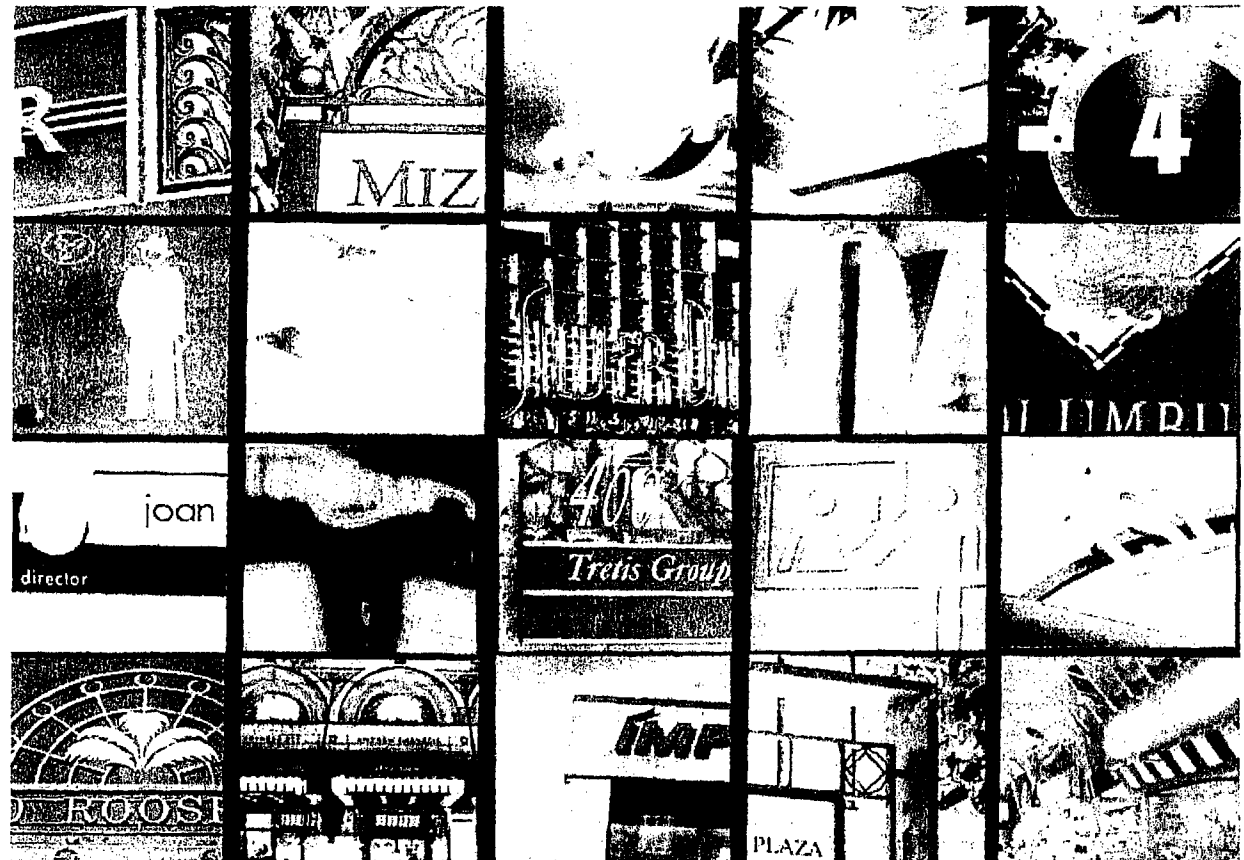

OVERVIEW

The overview of this sign criteria is to assist the Landlord/Tenant and city relationship.

The Landlord will be responsible to

- a) Provide base building design and construction information requested by Tenant's sign design consultant.
- b) Expedite the review, revision and approval of tenant sign submissions.

In return the Tenant will be responsible for:

Design, fabrication, permitting and installation of signs, including any structural support and electrical service and any special installation requiring addition or modification to the shell building approved by the Landlord:

MAINTENANCE OF THE SIGN.

The tenant shall employ sign fabricators and installers Approved by the Landlord who are well qualified in the techniques and procedures required to implement the sign design concept.

The Tenant will abide by all provisions, guidelines and criteria contained within Long Beach Plaza, Long Beach Sign Plan and these sign criteria.

Only those sign types provided for and specifically approved by the Landlord in Tenants sign submission documents will be allowed. The Landlord may, at his discretion and at the Tenant's expense, correct, replace or remove any sign that is installed without Landlord's written consent, or that is not executed in conformance with the approved submission.

Tenant shall furnish the Landlord with a copy of all sign fabrication and installation permits prior to installation.

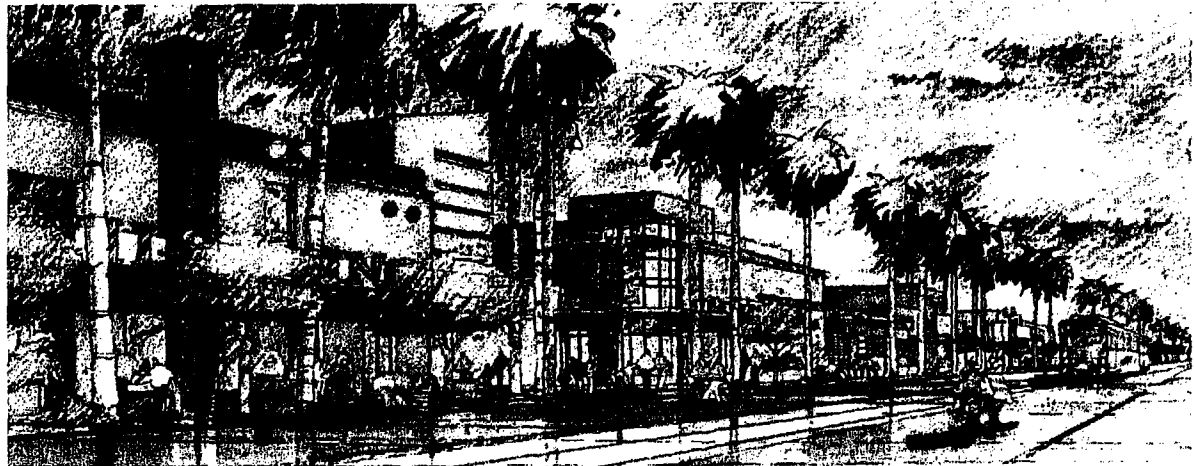



PRIMARY TENANT IDENTIFICATION

- Tenant is allowed one primary identification sign located above the store entrance in a specific area within the confines of the tenants store-front that makes better architectural sense.
- Specific suites with building elevations facing multiple exposures may incorporate one additional primary identification sign per exposure, subject to Landlord's approval.
- Signs may identify the business name and a minimum generic word description of the service. No product identity or specific service descriptions may be displayed.
- Unless treated as the primary identification sign, blade signs, flags, banners and window text sign, where permitted, shall not count against the Tenants' overall sign square footage allowance.
- Sign size is based upon the Tenants leased frontage, as measured in a straight line from lease line to lease line for each elevation.
- Tenants are allowed the following signable area.
- Irrespective of the size of all the tenants in the center, each tenant will be allowed 1-1/2 square feet of sign area per one (1) linear foot of store-front, with a maximum of 250 square feet for each of the elevations that the tenant has store exposure.

- The overall width of any sign shall not exceed 80% of any uninterrupted architectural treatment.
- The sign area stated above consists of the area of the copy only. However the Landlord encourages graphic license, which may incorporate a super graphic or icon (no copy) that that enhances or encompasses the storefront. This addition will be aesthetically part of the storefront and will not be counted as sign area. The final decision will be at the sole discretion of the Landlord.
- Awnings: The area of the sign may not exceed forty percent (40%) of the total face of the awning, not to exceed one hundred (100) square feet.

Marquee/canopy signs shall be contained entirely within the perimetric limits of the fascia of the marquee or canopy

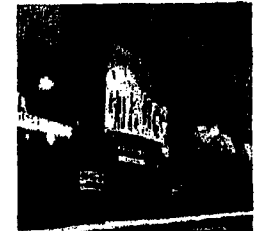

PROJECTING SIGNS

For some Tenants, the Landlord may require that the Tenant's Primary identification sign be a projecting sign. The sign and placement of these projecting signs will vary depending upon the store frontage and location, and will be determined at the sole discretion of the Landlord.

Projecting signs will be sized to complement the architectural elements on which they are placed. For Major tenants, signs may project a maximum of four (4'-0") feet from the building and have a maximum height of thirty (30'-0") feet or shall not exceed one (1) square foot per linear foot of building frontage from which the sign projects.

However, the exact size of the individual sign will be determined during the design and submission process, and will be subject to the City of Long Beach and the Landlord's final approval.

*Signage on architectural blades may exceed the height of the roofline of a building provided that the area onto which the sign is attached has been designed to be an integral part of the architecture. (See examples below)

Where a projecting sign becomes the Tenant's primary identification sign, the Landlord will permit a secondary storefront sign or marquee sign visible to pedestrians at the level of entry.

For other Tenant's where the Landlord will allow projecting signs, the signs may project a maximum of three feet eight inches (3'-8") from the building and have a maximum height of ten (10'-0"). The size of each sign is to be determined during the design and submission process and must complement the architectural style and scale of the area receiving the sign subject to the sole discretion of the City and Landlord.

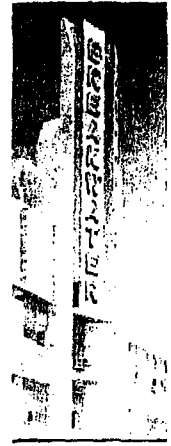
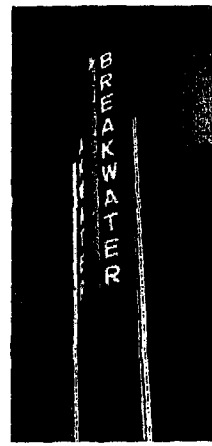
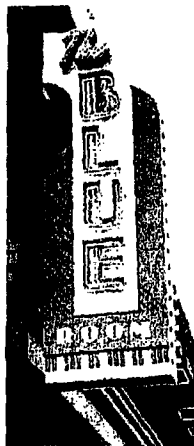

*Examples of blade signs that exceed the height of the Roofline but is an integral part of the architecture.

BLADE SIGNS

Each tenant is permitted one blade sign. The blade sign program requires that each Tenant's graphic identity be transformed into a three-dimensional double-faced sign. The Landlord encourages the tenant to propose blade sign designs, which enrich the pedestrian environment with a creative use of color and material combined with a strong store name identification.

Additionally:

Blade signs may be illuminated or non-illuminated. Illuminated signs may have an internal or external light source. Blade signs shall project no more than 3'-6" from the building face, and shall be no more than 3'-0" in height, with a maximum of 7-1/2 square feet of area for each face. Clearance from the underside of the blade sign to the finished common area paving shall be a minimum of 7'-6".

Proposals for blade sign designs will be reviewed at the time of the tenants overall sign design submission. It is the responsibility of the tenant to ensure that his fabrication and installation contractor includes adequate support for the blade sign all required electrical services and connection.

The blade sign may not be the primary store identification sign and will not be included in the calculation for the overall sign area permitted.

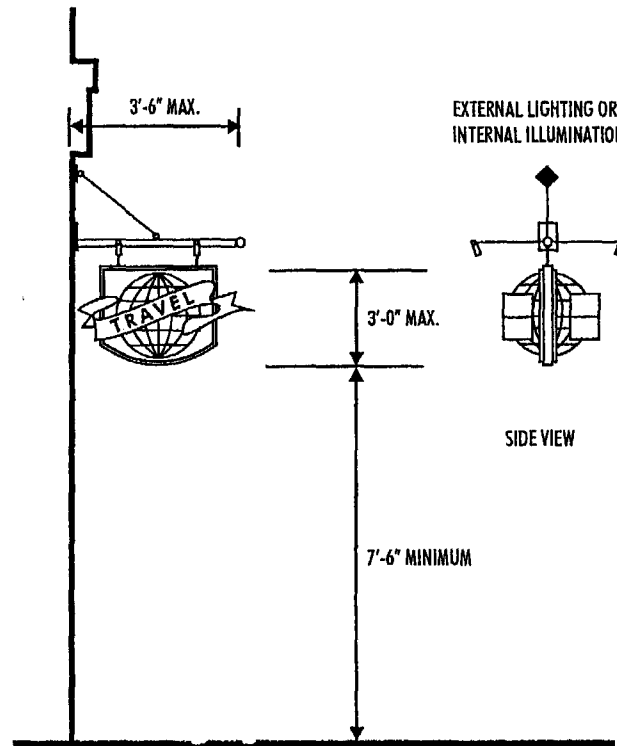
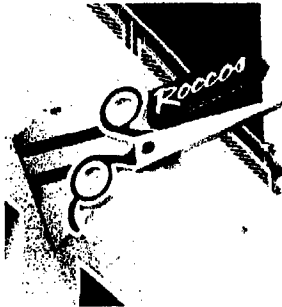

SIGN STYLES

There are many acceptable sign treatments including a mixed media approach combining several different fabrication and lighting techniques. Tenants are strongly encouraged to consider the specific architectural style of their façade, the overall concept of the project, the scale of the proposed sign and the critical viewing angles and sight lines when designing appropriate graphics and signs for the storefront. Note that specific locations and surrounding architectural treatments can limit the maximum sign height and length, which may differ from the general guidelines proposed above. The Landlord reserves the right to approve or reject any proposed sign on the basis of its size and placement.

Acceptable sign styles include:

1. Front and halo illuminated channel letters. Note: *acrylic face, internally illuminated channel letters will not be permitted unless successfully used as a part of an approved "mixed media sign";*
2. Mixed media, three dimensional signs painted gold, silver or copper leaf;
3. Halo illuminated letters, 3" deep minimum;
4. Channel letter with exposed neon, 2-1/2" deep minimum. Exposed neon will be approved at the sole discretion of the landlord and should be proposed only if a part of the overall tenant design concept;
5. Dimensional, geometric shapes;
Screens, grids, or mesh;
Etched, polished, patina or abraded materials;
6. Sand blasted, textured, and/or burnished metal-leaf faced dimensional letters, pin mounted from façade;
7. Signs mounted to hard canopies, eyebrows or other projecting architectural elements.

For example:

- a. Prismatic face letter forms with full facets strokes;
- b. Rounded face letter forms with radius faces and eased edges;
- c. Layered letter forms with face and liner. Letter face must be at least 1" thick, and the liner must be a minimum of 1/2 inch thick;

Exposed neon as a graphic accent.

Mixed media signs are signs employing two or more illumination and fabrication methods (for example, halo lit reverse channel letters with fiber optic accents). Although simple rectangular cabinet signs are generally not allowed, mixed media signs may be composed of several elements, one of which may be a cabinet. However, the cabinet sign should not exceed 50% of the total sign area. With the Landlord's approval, complex shaped (i.e. polyhedron) sign cabinets may be used alone if they incorporate dimensional elements such as push-thru letters and or exposed neon.



Front and halo illuminated letters



Halo illuminated channel letters



Dimensional geometric shapes



Mixed media ;
Exposed neon, halo neon, painted letters, burnished leaves, patina cabinets

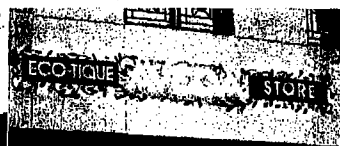

Rounded face letter forms



Exposed neon as a graphic accent



Channel letter with exposed neon

TYPE STYLES AND LOGOS

The use of logos and distinctive type styles is encouraged for all tenants signs. Sign lettering should be combined with other graphic and or dimensional elements denoting the type of business. The tenant may adapt establishes type styles, logos and/or images that are in use on similar buildings operated by the tenant in California, provided that these images are architecturally compatible and approved by the Landlord. The typeface may be arranged in one or two lines of copy and may consist of upper and/or lower case letters. The tenant should identify trademark protected type and marks in their sign submission to assist the Landlord in the review process.

COLORS

The following guidelines are for selecting colors for Tenant's signing. The project and the individual building façade will consist of a variety of colors and materials. The Landlord encourages the tenant to consider these colors when choosing his sign colors, and where feasible the Landlord will consider the tenants color scheme when making final building color and material choices. Tenants are requested to *make early color submission* for review by the Landlord, although final determination of building colors will follow from on site mock-ups and draw downs reviewed and approved during construction of the base building shell.

Signs may incorporate regionally and nationally recognized logo colors;
Sign colors should be selected to provide sufficient contrast against building background colors;
Sign colors should be compatible with and complement building background colors;
Sign colors should provide variety, sophistication and excitement;
Color of letter returns shall match the face of the letter or be a contrasting dark bronze for good daytime readability
Interior of open channel letters should be painted dark when placed against light backgrounds;
Neon colors should complement related signing elements.

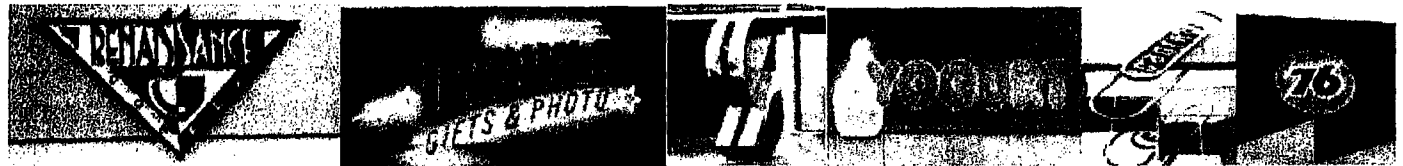

LIGHTING

Tenant signs should be creatively illuminated using a variety of lighting techniques. One or more of the following are allowed:

1. Front and halo illuminated channel letters
2. Halo illuminated pin-mounted reverse channel letters;
3. Reverse channel neon with silhouette illumination
4. Open channel with exposed neon
5. Fiber optics;
6. Incandescent light bulbs;
7. Internally illuminated signs with seamless opaque cabinets and pushed-thru lettering and/or neon.
8. Cove lighting.

All front lighting must be baffled and obscured from direct visibility with recessed channels which are fully integrated into the building façade elements. Decorative shrouds or housings custom designed and fabricated to maintain or enhance the architectural integrity of the building may be used to conceal "off the shelf" standard fixtures subject to Landlord's approval. Visible standard (non-custom) "gooseneck" lamps and similar fixtures will not be approved. All housings and posts for exposed neon signs must be painted to match or complement the building façade color immediately behind and adjacent to the sign.

Neon outlining of buildings:

Neon tubing lighting and stringed lighting used to outline buildings or emphasize architectural elements of a building shall not be considered sign illumination but rather an architectural element subject to review and approval through the site plan review process as specific in the Long Beach City – Sign Code – Division V of Chapter 21.25 – Specific Procedures.



Cabinet with 3/4" pushed through letters

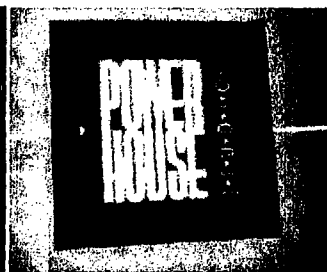

Illuminated cabinet with routed copy backed with acrylic. Cabinet also has halo.



Front illuminated with incandescent light bulbs

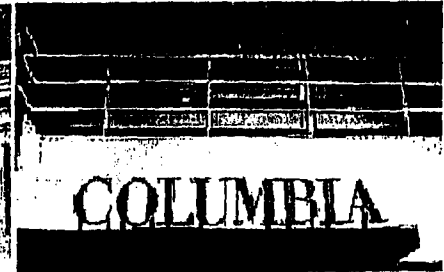

Cove lighting

APPROVAL

Three Step Process

The landlord has engaged the services of a sign consultant for the entire project who will assist in the review and approval of tenant sign submissions and insure their conformance to the project's overall Sign Criteria.

- A. At least thirty (30) days prior to the Landlord's scheduled delivery of the premises, tenant shall provide the following information to the Landlord for review. This information is separate from sign approval submission and store design and drawing submissions, and will be used to begin the sign design process.

Store name;
Store logo (in color with colors identified);
Store interior materials, colors and finishes.

- B. Allowing reasonable time for Landlord's review and tenant's revision of submission in advance of sign fabrication, tenant shall submit for Landlord's approval five (5) sets of complete and fully dimensioned shop drawings of the tenant's sign to the Landlord's sign design consultant at the following address:

[Redacted address area]

Shop drawings shall include at least the following:

- Tenant's entire building façade elevation, showing the proposed sign, in color drawn to scale of 1/4" = 1'-0".
- Storefront (partial building) elevation showing the location. Size, color, construction and installation details of the tenants proposed sign.
- Typical "section-through" letter and/or sign panel showing the dimensioned projection of the letter or panel face and the illumination method.
- Color and material samples together with a photograph (if possible) of a similar installation.

Within twenty one (21) days of receipt of the sign submission, the Landlord will approve, as noted, or disapprove with comments the tenant's sign design. Tenant must respond to the Landlord's comments and re-submit within fourteen (14) calendar days, and repeat this process until all sign design, fabrication and installation issues are resolved to the Landlord's satisfaction.

- C. Upon receipt of final sign approval, tenant shall submit the proposed sign to the City of Long Beach for issuance of a sign permit and approval of the required fabrication and installation permits.



FABRICATION

1. The tenant must insure that his sign fabricator and installer understand their responsibilities and before they begin sign fabrication. The tenant's sign contractor(s) are responsible for the following:
2. Signs must be fabricated of durable appropriate weather resistant materials complementary to the base building materials;
3. Dissimilar metals used in sign fabrication shall be separated with non-conductive gaskets to avoid electrolysis. Additionally, stainless steel fasteners shall be used to attach dissimilar metals;
4. Threaded rods or anchor bolts shall be used to mount sign letters which are held off the background panel. Angle clips attached to letter sides will not be permitted.
5. Colors, materials and finishes shall exactly match those submitted to and approved by the Landlord.
6. Visible welds and seams shall be ground smooth and filled with auto body compound before painting.
7. No fasteners, rivets, screws or other attachment device shall be visible from any public vantage point;
8. Finished metal surfaces shall be free from canning and warping. All sign finishes shall be free of dust, orange peel, drips and runs and shall have a uniform surface conforming to the highest industry standards;
9. Reverse channel letters shall be pinned 2" off the wall. The letter return depth shall be 3", and letters shall have a clear *Lexan* backing.
10. Double neon tube shall be used where the width of the letter stroke exceed 2 ½ inches.

INSTALLATION

The Tenant's sign installer will:

Provide the Landlord with an original certificate of insurance naming the Landlord as an additional insured for liability coverage in the amount of One Million Dollars (\$1,000,000) prior to beginning fabrication;
Obtain all required sign permits from the City of Long Beach and deliver copies to the Landlord;
Keep a Landlord approved set of sign drawings on site when installing the sign;
Warrant the sign against latent defects in materials and workmanship for a minimum of one year.

PROHIBITED SIGN-STYLES

1. Unadorned rectangular cabinet signs with translucent or opaque faces;
2. Temporary wall signs, pennants, banners, inflatable displays or sandwich boards, unless specifically approved by the Landlord;
3. Window signs unless approved by the Landlord (Note: box signs hanging in display windows are not allowed.
4. Gold leaf treatments on windows, and limited use of exposed neon in window displays will be allowed subject to Landlord approval);
5. Exposed junction boxes, wires, transformers, lamps, tubing, conduits, raceways or neon crossovers of any type;
6. Signs using trim-cap retainers that do not match the color of the letter and logo returns (polished gold, silver or bronze trim caps are not permitted);
7. Pre-manufactured signs, such as franchise signs, that have not been modified to meet these criteria;
8. Paper, cardboard or Styrofoam signs, stickers, or decals hung around or behind storefronts;
9. Exposed fasteners, unless decorative fasteners are essential to the sign design concept;
10. Simulated materials such as wood grained plastic laminates or wall coverings;
11. Flashing, oscillating, animated lights or other moving sign components, except as specifically approved by the Landlord;
12. Rooftop signs or signs projecting above roof lines or parapets;
13. Signs or mansard roofs or equipment screens;
14. Advertising or promotional signs on parked vehicles.

ITEM 1 PROJECT IDENTIFICATION SIGN

ITEM 2 VEHICULAR DIRECTIONAL SIGN

ITEM 3 PARKING STRUCTURE ENTRY SIGN

ITEM 4 TENANT PYLON (NO PROJECT I.D.)

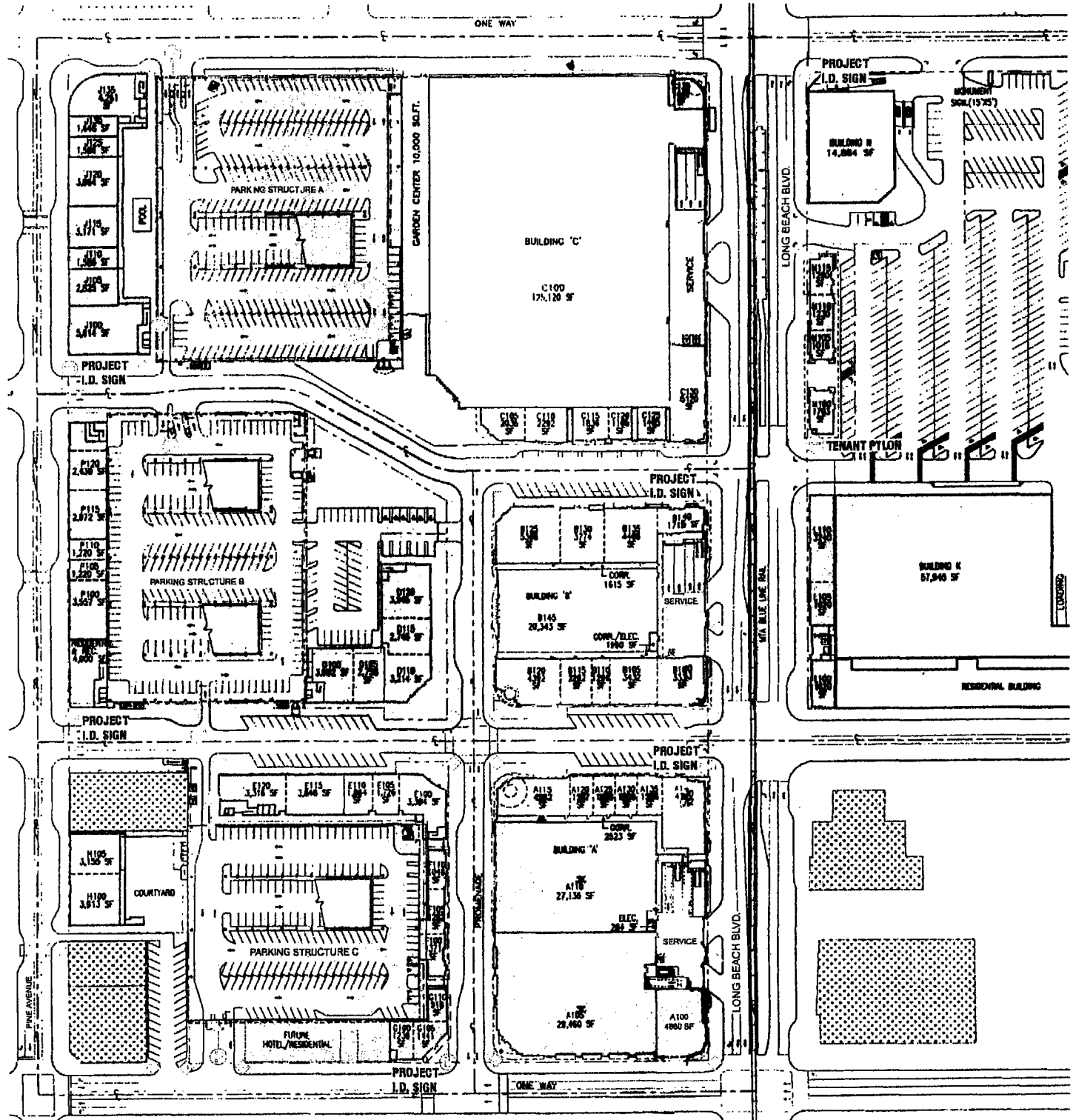

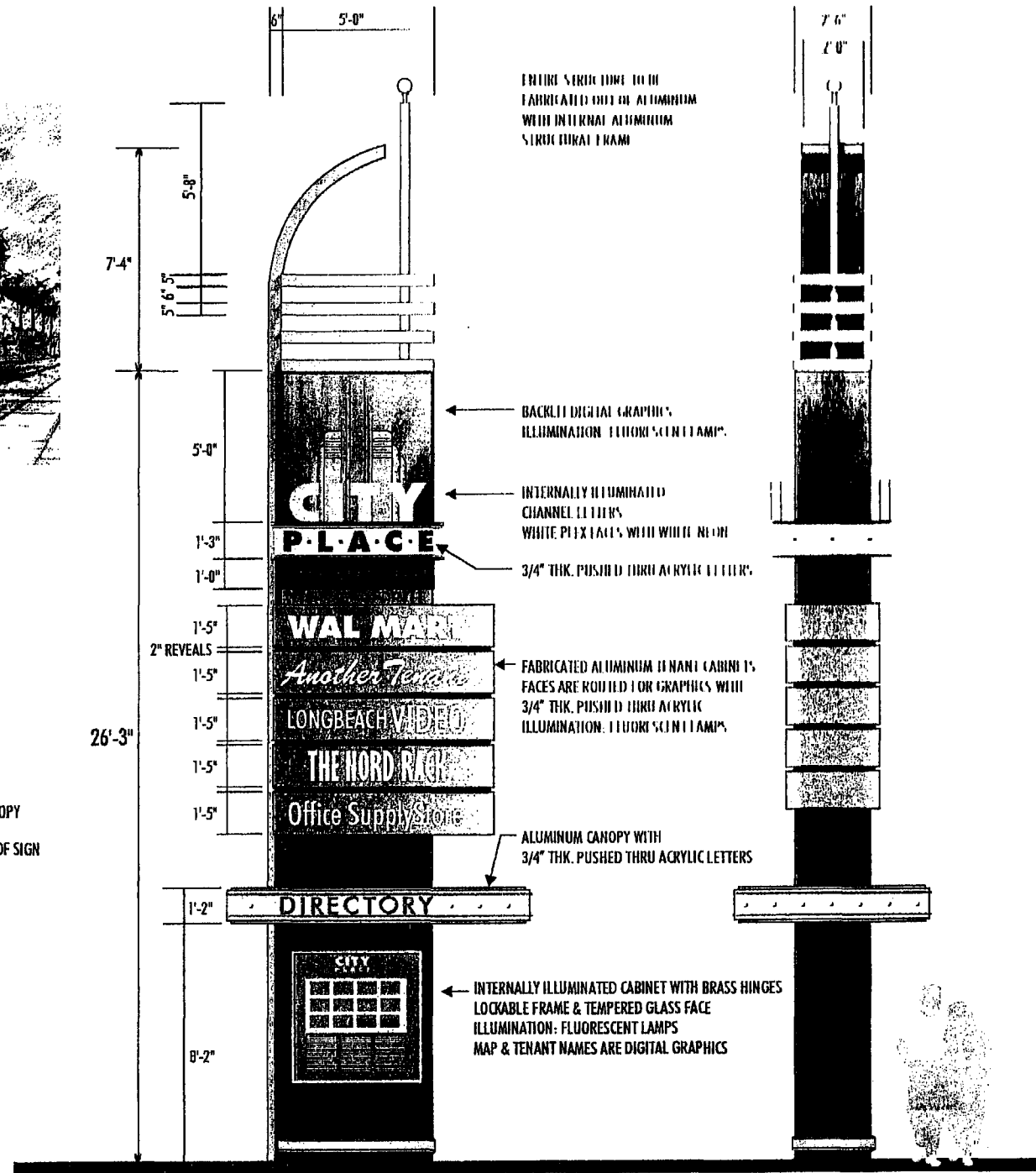
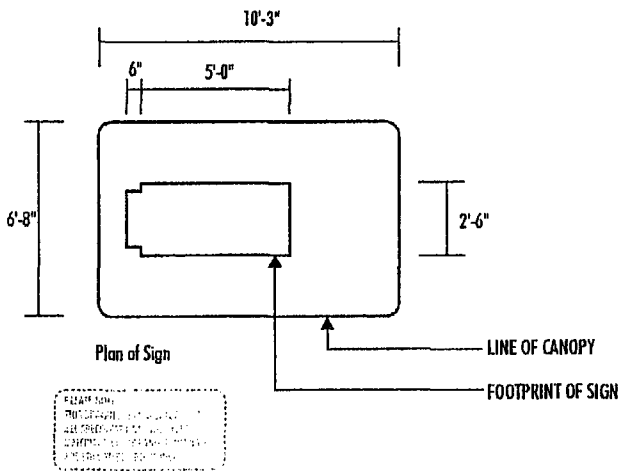

SCALE: 3/16" = 1'-0"

ITEM: 3
PARKING ENTRY IDENTIFICATION

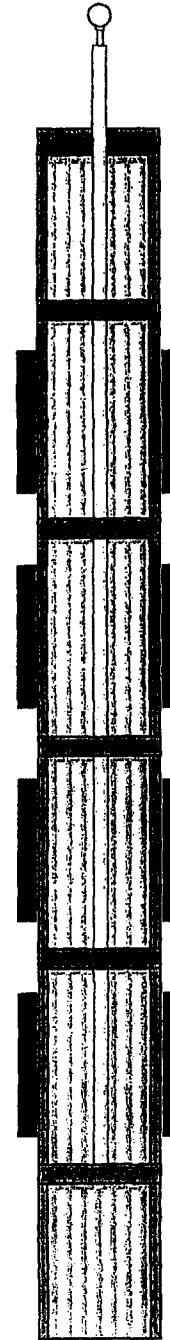
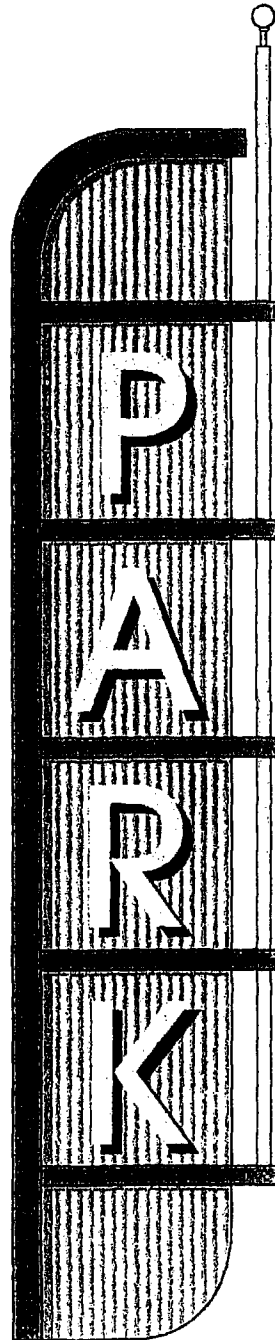

PLEASE NOTE:
THIS DRAWING IS CONCEPTUAL ONLY.
ALL SPECIFICATIONS, CALL OUTS
MATERIALS, COLORS AND ILLUMINATION
ARE STILL TO BE DETERMINED.

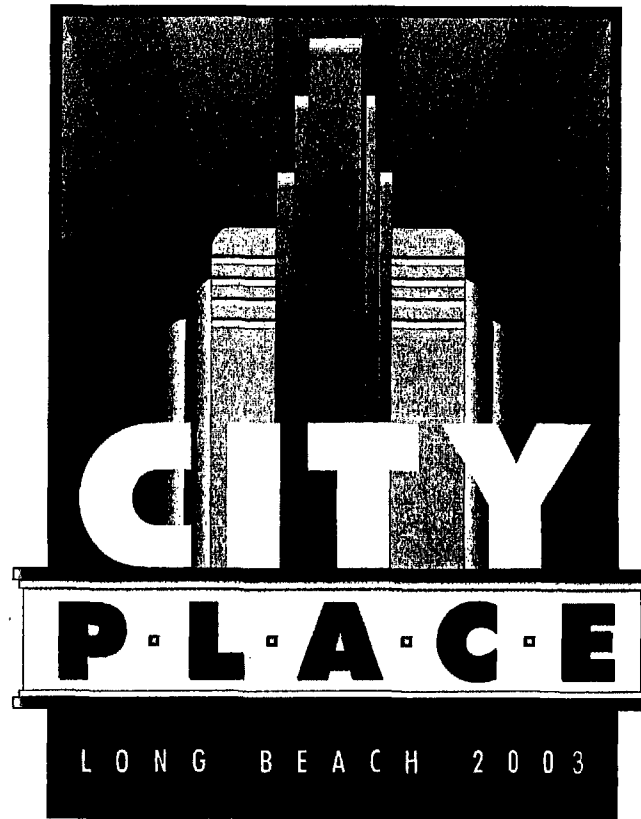

Tenant Design Criteria

MARCH 2002

TABLE OF CONTENTS

1. INTRODUCTION AND OBJECTIVES 1	4. TECHNICAL REQUIREMENTS 50
a. Location 4	a. Heating, Ventilation and A/C 50
b. Key Map..... 5	b. Plumbing..... 52
c. Districts..... 6	c. Gas and Electric..... 53
2. TENANT DESIGN CRITERIA.....7	d. Ceilings 55
a. General Storefront Criteria..... 8	e. Structural 56
b. Pine Avenue District..... 10	f. Lighting 56
c. Central Plaza District..... 14	g. Telephone 57
d. The Inner Village District..... 21	h. Fire Protection 57
e. Long Beach Boulevard District..... 28	i. Restaurant Tenants..... 59
f. Restaurant Design Criteria 32	5. TENANT PLAN SUBMITTAL 61
g. General Signage Criteria 33	6. PLAN CHECK / PERMIT PROCESS 64
3. DIVISION OF WORK 41	7. GENERAL INFORMATION 68
a. Landlord..... 41	a. Project Directory 68
b. Tenant..... 42	b. Plan Check and Utilities Directory 69
	c. Jurisdiction and Codes 69

1. INTRODUCTION AND OBJECTIVES

Introduction: Welcome to Long Beach CityPlace, where the engaging qualities of architecture reminiscent of yesteryear have been skillfully re-created within a new and exciting downtown environment. Long Beach CityPlace features a mixed-use roster of tenants, retail, restaurants, cafes and delis, together with residential uses to create a viable neighborhood environment.

Featuring urbanized streets with a pedestrian-friendly focus, Long Beach CityPlace will awaken the core of the city with a bustling of activity both night and day. The heart of this project features a lively landscaped plaza centered on the intersection of 4th and Promenade Streets.

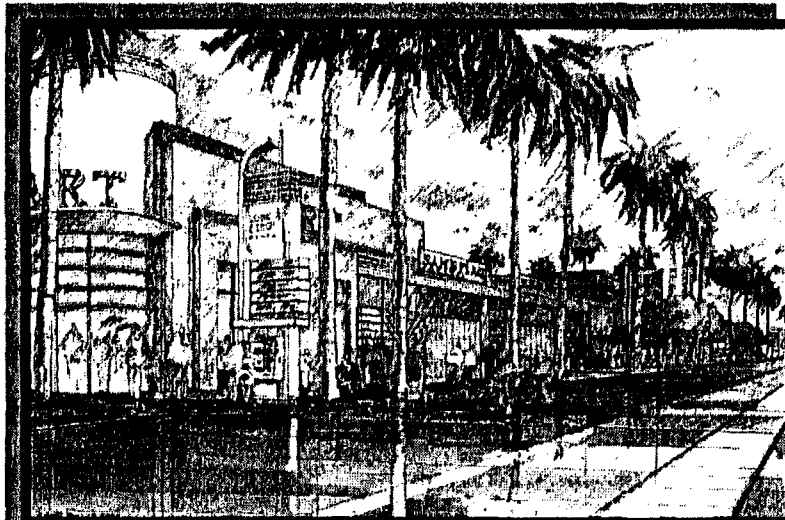

Artist's rendering of Long Beach Boulevard at Third Avenue

Long Beach CityPlace incorporates quality walkways and public areas, encouraging pedestrian activities throughout the project. Specialty paving, ornamental shrubs, seasonal planting beds, decorative lighting, outdoor seating, and gathering spaces at key intersections, will all be used to create a memorable downtown experience.

Three adjacent parking structures offer convenient parking to all storefronts within the project, and are but only one of three types of parking that will be available throughout CityPlace. Additionally, diagonal street parking will be available at numerous storefronts, together with off-street parking lots in several locations. All parking will feature clearly delineated paths of travel between parking lots and storefronts.

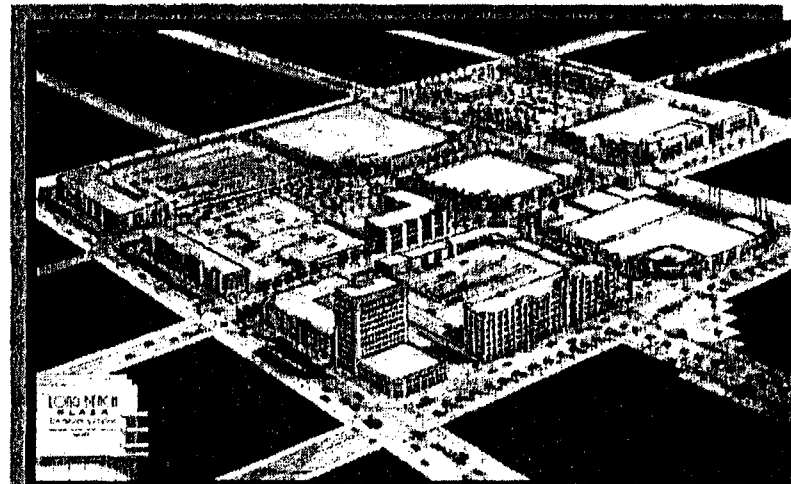

Artist's illustration showing bird's eye view of Long Beach CityPlace

LONG BEACH CITYPLACE

Long Beach CityPlace is walking distance from several tourist-oriented facilities such as the downtown convention center, featuring newly expanded exhibit facilities totaling 334,000 square feet. Other attractions include the Queen Mary cruise ship and hotel, and the Long Beach Aquarium, and the themed retail/entertainment destination project The Pike, currently under construction.

Prevalent within the existing architectural character of Long Beach, are many fine examples of the Art Deco styling of the 1920's. Curved casement windows, columned balconies and carved artstone scrolls along the roofline, are all to be found in the vicinity of Long Beach CityPlace.



Pine Avenue in downtown Long Beach has experienced much rejuvenation in recent years



Objectives: The success of Long Beach CityPlace is in large part, dependant on the Tenant's ability to create and contribute to a dynamic and diverse downtown environment. It is the Landlord's desire to encourage the most thoughtful and creative Tenant storefront expression, as it will serve to strengthen and compliment the overall project image. To that end, this Tenant Design Criteria Document has been provided to guide each Tenant through the process of creating their store identity. Additionally, the Landlord has selected a Tenant Coordination Team to serve as a liaison between the Landlord and the Tenant, their architects, designers, engineers and contractors.

Tenant Coordination Team: 3rd Works LLC serves as the Landlord's Representative and your sole point of contact for all Tenant Coordination efforts regarding Tenant design and construction. It is the purpose of the Tenant Coordination Team to help Tenants open their stores on time and to ensure their stores are architecturally compatible with, and of the same design quality as, the project as a whole.



LONG BEACH CITYPLACE

1.a. Location

Long Beach CityPlace is centrally located within the downtown district of the city of Long Beach, in southern California.

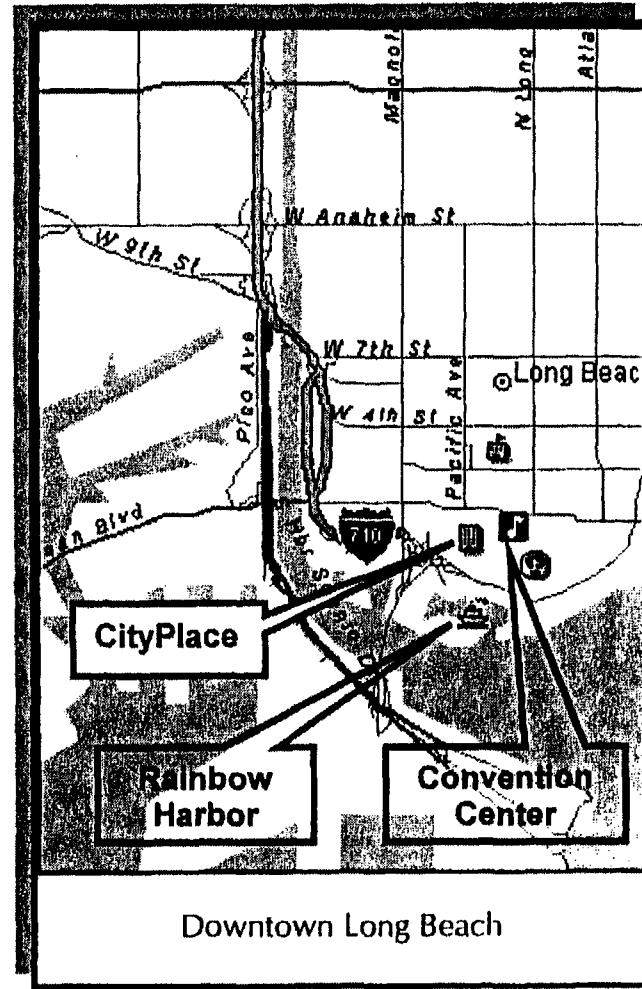
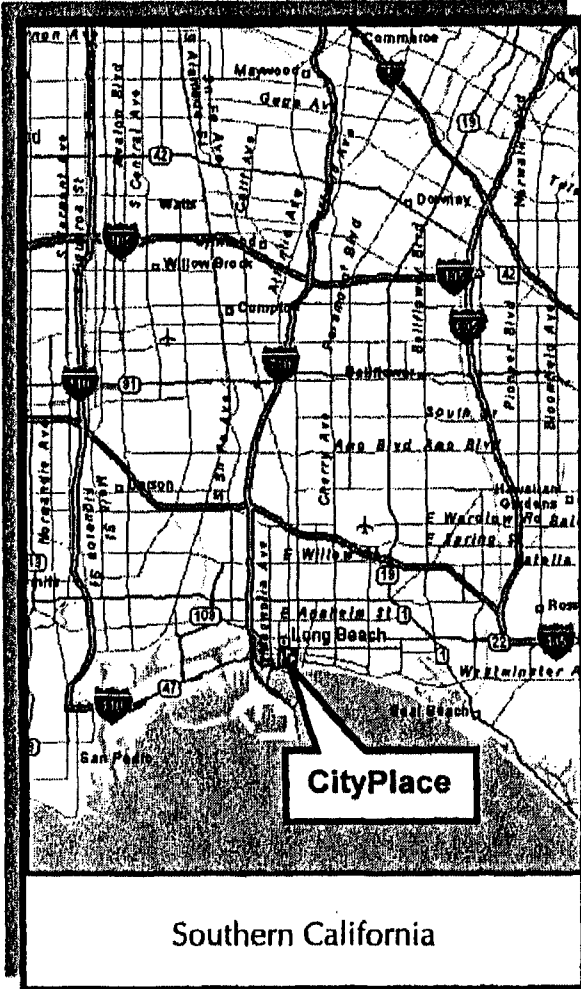

LONG BEACH CITYPLACE

1.b. Key Map

The project site is bordered on the north by 6th Street, on the west by Pine Avenue, on the south by 3rd Street, and on the east by Long Beach Boulevard. The Long Beach transit system runs north-south along Long Beach Boulevard.

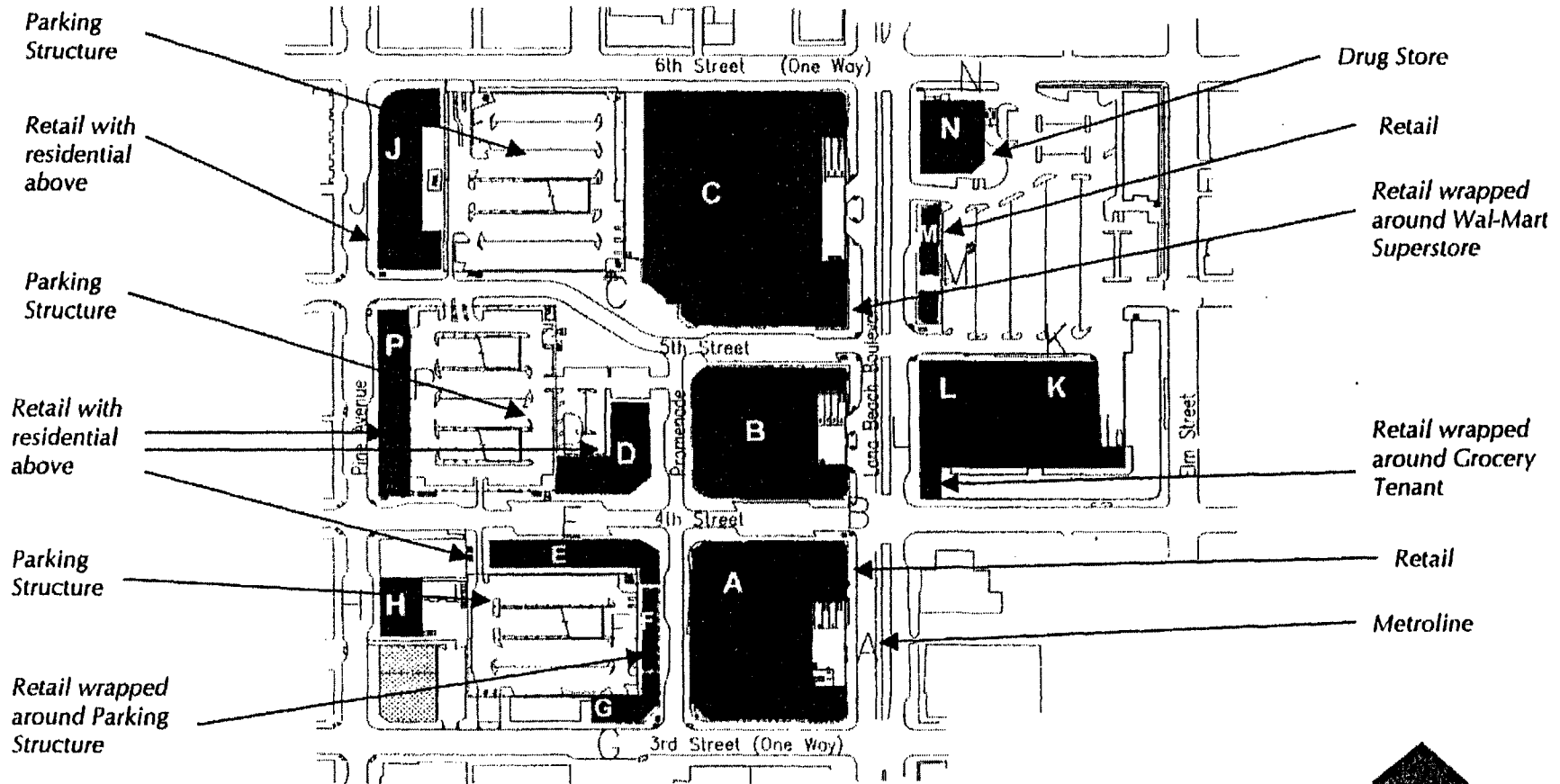

The dark shaded buildings within the Key Map above are denoted by letters A, B, C, D, E, F, G, H, J, K, L, M, N, and P



LONG BEACH CITYPLACE

I.c. Districts

This Tenant Design Criteria Document divides the Long Beach CityPlace project into four focused design districts; The Long Beach Boulevard District; The Central Plaza District; The Pine Avenue District; and The Inner Village District. Tenants should refer to the District Key Map below to determine which district their lease space is in, and refer to the applicable district criteria when designing their storefronts and signage.

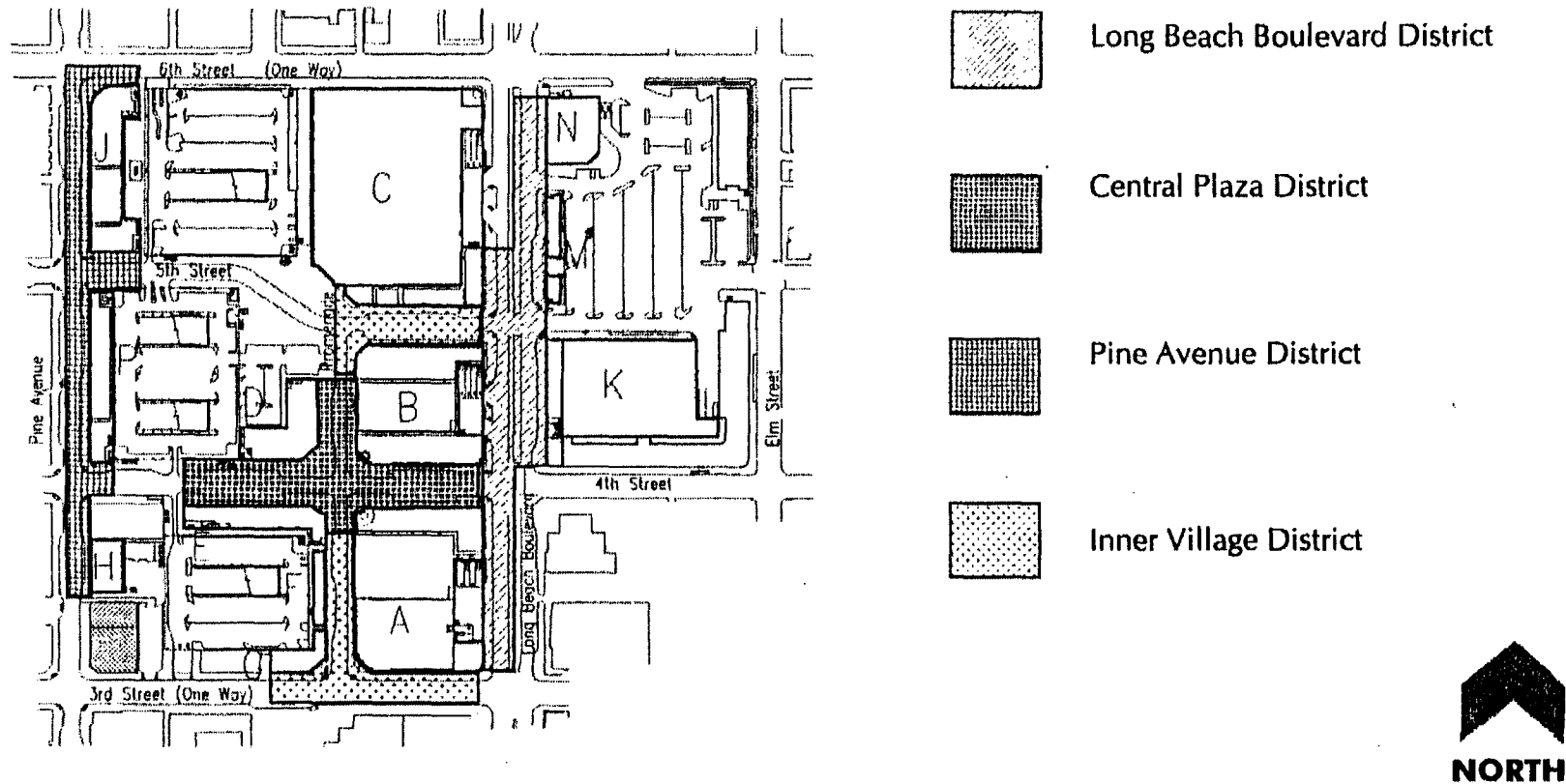

2. TENANT DESIGN CRITERIA

Tenant Design Criteria: This document contains the Tenant Design Criteria and includes both the Architectural and Design Criteria referred to in the Tenant's Lease Agreement. This document has been prepared to inform and assist you, the Tenant's architect or designer, and engineer in understanding and responding to the requirements of the Tenant's lease.

The criteria contained in this document, the lease, and the lease exhibits are intended to encourage quality design and to establish a common point of departure for the benefit of all Tenants. The information contained within this document may restate requirements contained in the Tenant's lease and its exhibits. When ambiguity or inconsistency occurs concerning design issues, the requirements of this document will take precedence.

This document provides both design and technical criteria for Tenant's improvements to storefronts, ceilings, lighting, floors and signs. In addition to this document, refer to the *Contractor Guidelines*, which has been prepared similarly to assist the Tenant's contractor. Tenants should discuss specific thoughts about their design concepts and raise any questions about the criteria with the Landlord's Tenant Coordination Team before beginning preliminary design work.

Any renderings, drawings and floor plans contained in this document are included for illustrative purposes only to

help Tenants comply with the design criteria. The actual design and configuration of each Tenant space may vary from such renderings, drawings and floor plans. In case of deviations between these illustrative drawings and the Tenant's Lease Outline Drawing (LOD), the latter will govern.

The design criteria for Tenant's storefront, awnings and signage at the Long Beach CityPlace project falls into three possible categories; General Criteria, District Criteria, and Restaurant Criteria. Each Tenant's storefront design must also adhere to its applicable District Criteria.



Artist's rendering of Long Beach CityPlace street frontage

LONG BEACH CITYPLACE

2.a. General Storefront Criteria

The current design of the public areas and building exteriors at Long Beach CityPlace is based on input from the City of Long Beach and its preliminary design guidelines. The project's architectural style was established through a contemporary reinterpretation of the materials and forms originally found in the historical buildings that are an essential part of Long Beach's historic character.



Several structures bordering Long Beach City Place incorporate rich historical detail.

The design challenge of Long Beach CityPlace is to break down the scale of the project and create diversity in the storefronts while using a locally appropriate design vocabulary and palette of materials. The thoughtful and creative design of Tenant storefronts is a great asset to Long Beach CityPlace. Quality Tenants recognize that materials, lighting, and well-designed graphics are an important component to their merchandising strategy. The Landlord will impose standards of quality and appropriateness on tenants while encouraging them to create distinctive and attractive design solutions for their stores.

Tenant's Design Control Zone: The Tenant's Design Control Zone is a 10'-0"-deep area extending from the lease line inward and running the full width and full height of the storefront. The Landlord considers this zone an extension of the storefront into the store interior. The flooring, ceilings, lighting and displays shall be treated as a visual window into the merchandising area of the Tenant space.

Tenant may recess storefront from lease line for a maximum of 50% of the distance between neutral piers. In such cases, Tenant must match sidewalk elevations within recessed area.

Not Permitted:

- Tinted, reflective or spandrel glass.
- Bronze-anodized finishes.
- Projections beyond lease line at the ground plane.
- Exposed metal framework for awnings or banners, unless it is architecturally embellished.
- Drywall or fiberglass awnings.
- Art Deco styled light fixtures in exterior applications.
- Track lighting visible from sidewalks.
- Exposed lamps, non-decorative, or utility bulbs.



2.b. Pine Avenue District

The Pine Avenue District is located on Pine Avenue and will become a visual extension of the eclectic quality that is currently occurring to the south. The architectural character of Pine Avenue is diverse and storefronts are varied in their options.

Storefront design within the Pine Avenue District should employ a busy and colorful multi-patterned palette, thematically designed to engage and catch the eye of passersby and traffic. Detailing should also be utilized that captures the spirit of the Art Deco period.

District Traits

- Storefronts: Variety and diversity; stress individuality with custom designs, multi-paned, transoms encouraged
- Base: 12" required, busy-patterned and multi-colored; intentional non-conforming to one another
- Colors: pastels, muted variations of deeper tones
- Signage: Flair, style and eccentricity must stress creativity



Several examples of the eclectic architectural character of Pine Street

LONG BEACH CITYPLACE

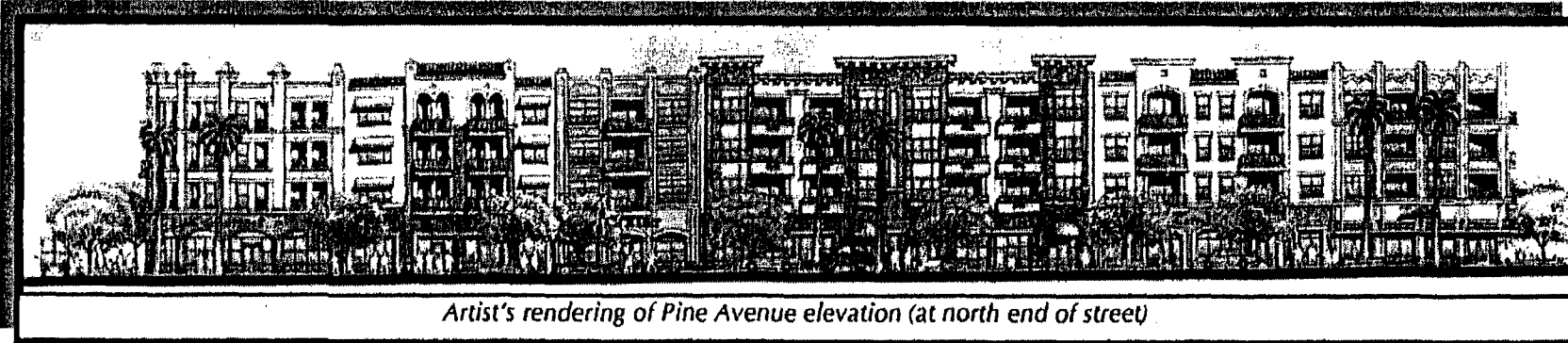

Storefront Criteria:

- Refer to Tenant's L.O.D. package for space-specific storefront heights and the conditions and parameters of the Tenant's Design Control Zone.
- It is recommended that storefront materials consist of painted wood or painted (baked-enamel) aluminum. Pastel colors and muted versions of richer colors common to the Art Deco palette are recommended.
- Custom-designed thresholds are greatly encouraged to enhance the pedestrian experience on Pine Avenue. Mosaic tile patterns, inlaid glass, metal, inlaid stone tile, or patterns that utilize the Tenant's logo are encouraged.
- Multi-paned storefront glass, working transoms, and mullions that employ complementary colors are encouraged.

- A 12-inch base is required, of tile, stone or metal finish.
- Where appropriate, sidewalk seating may be provided by the tenant. Exterior furniture to be used by the Tenant (i.e. tables, chairs, trash receptacles, umbrellas, fireplaces, etc.) should be of high quality, and are subject to final approval from the Landlord.
- Tenants will be encouraged to employ design detail consistent with the Art Deco period within entry doors and door hardware.

Prohibited within Storefront:

- All items/materials that are listed as "Not Permitted" under the Tenant Design Criteria (Paragraph 2).
- Primary colors, except in cases where they are an integral component of the Tenant's logo, should be avoided.
- High-gloss finishes on painted wood, or polished stone are not permitted.

LONG BEACH CITYPLACE

Awnings and Banners:

- Awnings will be considered on a case-by-case basis within the Pine Avenue District.
- Horizontal louvered projections will be considered on a case-by-case basis.
- Awnings with clean lines and straight horizontal edges are preferred and scalloped edges should be avoided.
- Fabric awnings must be constructed of code-approved materials. Refer to local code restrictions to avoid possible sprinkler requirements.
- Under-lit awnings are encouraged for use in this district.
- Vertical banners may be used. The maximum horizontal projection from the vertical face of storefront is 24 inches. The bottom of the banner must clear 7'-6" A.F.F.

Lighting:

- Specialty light fixtures reminiscent of the Art Deco period are recommended within the Pine Avenue District when used in exterior locations (i.e. wall sconces).
- A variety of night-lighting methods should be utilized to better serve pedestrians after dark. Tree lights, wall sconces, cove-lighting, neon signage, and soffit lights directed at entrances and store window displays, are all recommended for this district.



Examples of Awnings
and Banners

LONG BEACH CITYPLACE

- Within this district, all vertical projections utilized within the storefront design or signage should employ wall washes and/or recessed neon for emphasis.
- Under-lit awnings are encouraged for use in this district.

Signage:

- A sense of flair, style and eccentricity should be the driving force behind sign design on Pine Avenue. Signage should be creatively designed, well proportioned and provide visual appeal to pedestrians and passing traffic.
- A minimum of one Primary sign and one Blade sign is required.
- All vertical projections utilized within the storefronts in this district should employ wall washes and/or recessed neon for emphasis.
- Signage incorporated onto awnings, horizontal canopies or vertical projections is encouraged for use in this district.
- Wherever possible, sign design and graphics that are reminiscent of the Art Deco period are recommended within the Pine Avenue District

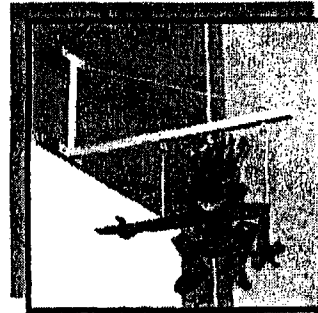

Examples of Primary and Blade signage for Pine Avenue District

2.c. Central Plaza District

The Central Plaza District is a crossroads within the Long Beach CityPlace, occurring at the intersection of 4th Street and Promenade. Diagonal parking at the storefronts slows down traffic, and help to invoke a "Town and Country" atmosphere. The main plaza at this intersection opens up to create a focal point for the project, generating opportunities for outdoor dining and spontaneous pedestrian activities.

Creating a "larger-than-life" atmosphere is the thematic driving force within the Central Plaza District. Boldly colored and scaled storefronts, with large bright signage, will serve to attract traffic and pedestrians to the central core of the project.

District Traits

- Storefronts: More glass area, less or no multi-paned glass
- Base: no base required
- Detailing (doors, handles, etc.): Should be "larger than life," echoing Art Deco detailing
- Colors: deeper, bolder, and covering larger areas
- Finishes: High gloss wood or baked enamel on aluminum
- Signage: Bigger is better, suggest bold and creative uses of neon

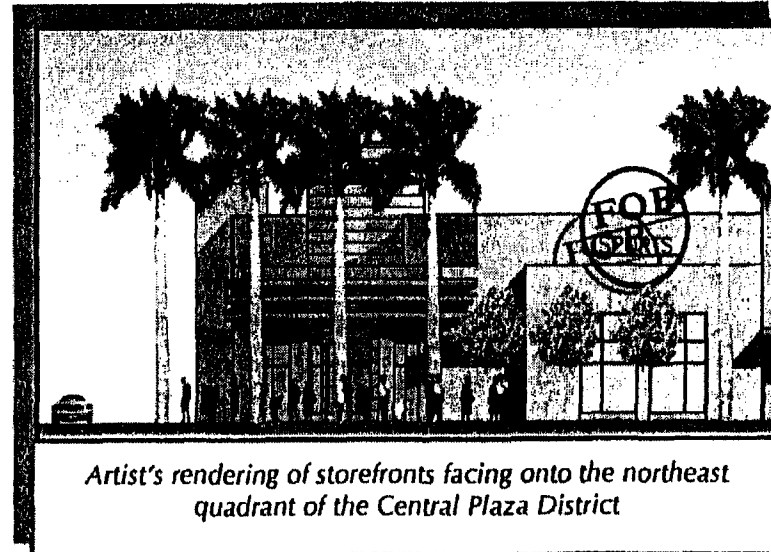

Artist's rendering of storefronts facing onto the northeast quadrant of the Central Plaza District

- Lighting: Suggest recessed neon and Tivoli lights for outline emphasis

Storefront Criteria:

- Refer to Tenant's L.O.D. package for space-specific storefront heights and the conditions and parameters of the Tenant's Design Control Zone.
- It is recommended that storefront materials consist of painted (baked-enamel) aluminum or high-gloss painted finishes on wood. Deep tones of muted colors are recommended. Light pastel colors are discouraged.
- Larger sections of storefront glass, without unnecessary mullions, are encouraged.

LONG BEACH CITYPLACE

- Storefront bases are required. Recommend that colorful or metallic finishes be used.
- Where appropriate, sidewalk seating may be provided by the tenant. Exterior furniture to be used by the Tenant (i.e. tables, chairs, trash receptacles, umbrellas, fireplaces, etc.) should be of high quality, and are subject to final approval from the Landlord.
- Tenants will be encouraged to employ "larger-than-life" details echoing the Art Deco period surrounding the tenant's entrance and at the parapet.

LONG BEACH CITYPLACE

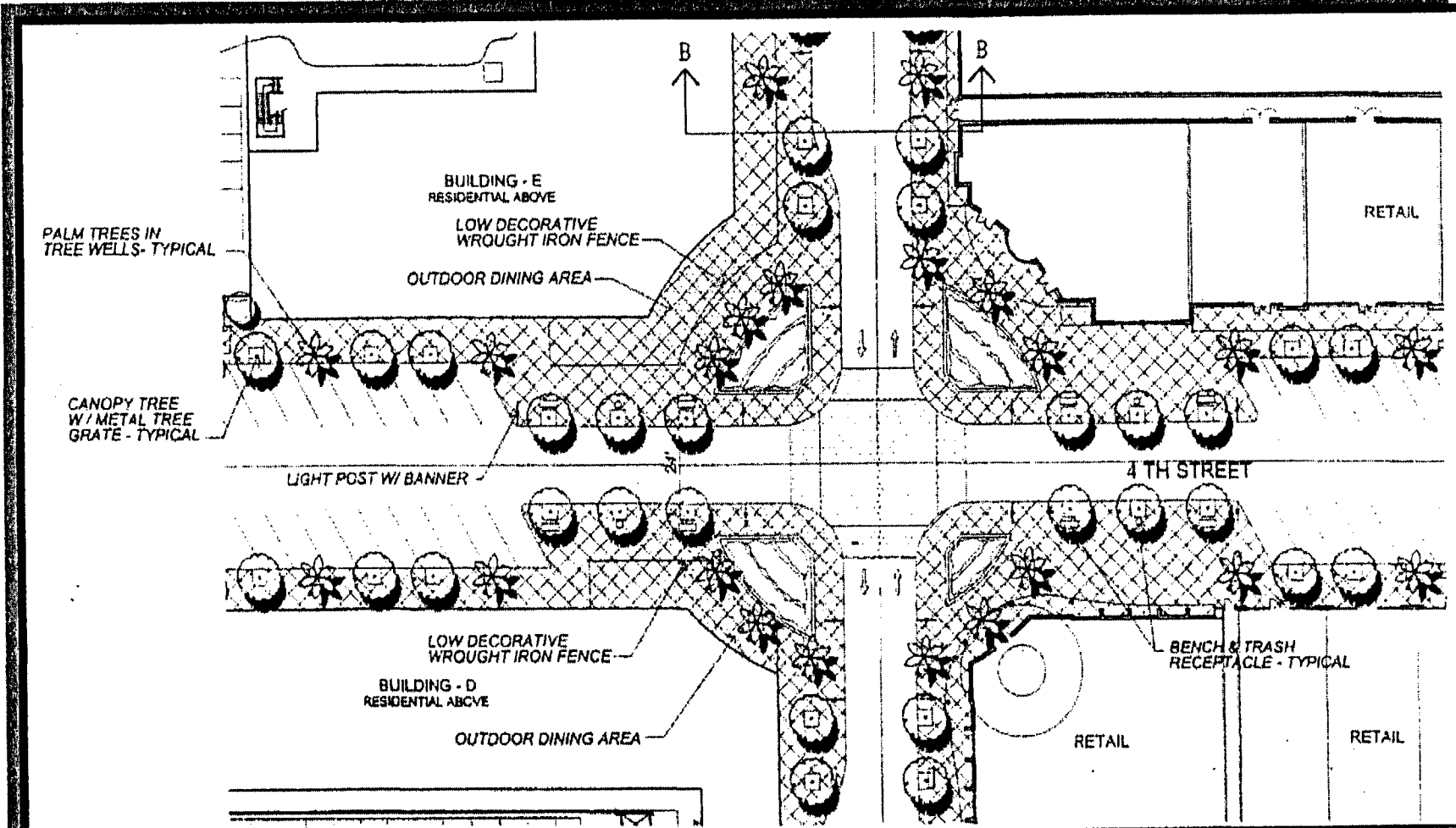

Plan view of Central Plaza District

LONG BEACH CITYPLACE

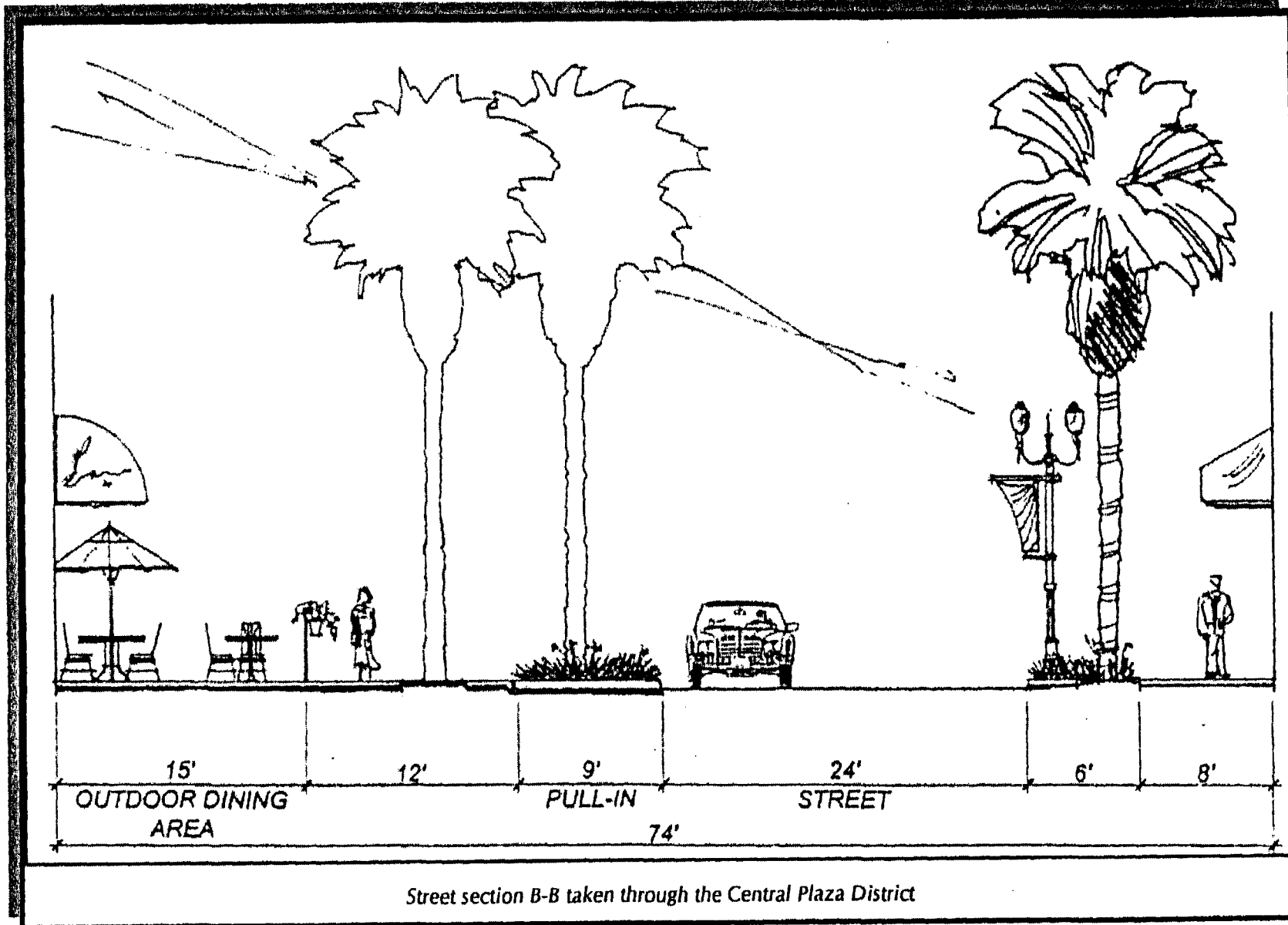

Prohibited within Storefront:

- All items/materials that are listed as "Not Permitted" under the General Tenant Criteria.
- Primary colors, except in cases where they are an integral component of the Tenant's logo, should be avoided.

Awnings and Banners:

- Awnings, canopies and horizontal louvered projections are encouraged within the Central Plaza District.
- Awnings with clean lines and straight horizontal edges are encouraged. Scalloped edged canopies are prohibited.
- Fabric awnings must be constructed of code-approved materials. Refer to local code restrictions to avoid possible sprinkler requirements.
- When awnings are used, under-lit awnings are encouraged for use in this district.
- Vertical banners are encouraged within the Central Plaza District. The maximum horizontal projection from the vertical face of storefront is 24 inches. The bottom of the banner must clear 7'-6" A.F.F.



Bold horizontal canopies are preferred within the Central Plaza District



Signage:

- A sense of “larger-than-life” should be the driving force behind sign design within the Central Plaza District. Signage should be creatively designed, well proportioned and provide visual appeal to pedestrians and passing traffic. Mixed media signage is encouraged.
- A minimum of one Primary sign is required.
- All vertical projections utilized within the storefronts in this district should employ wall washes and/or recessed neon for emphasis.
- Signage incorporated onto awnings, horizontal canopies or vertical projections is encouraged for use in this district.
- Wherever possible, sign design and graphics that are reminiscent of the Art Deco period are recommended within the Central Plaza District

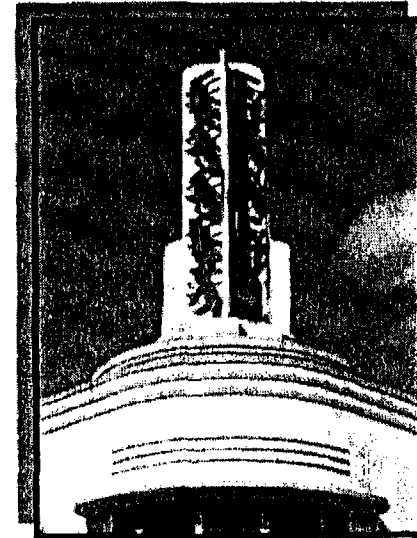

Examples of Primary Signage for the Central Plaza District

Lighting:

- The bold and creative use of neon is strongly encouraged within the Central Plaza District
- Specialty light fixtures reminiscent of the Art Deco period are recommended within the Central Plaza District when used in exterior locations (i.e. wall sconces.)
- A variety of night-lighting methods should be utilized to attract traffic and pedestrians after dark. Wall sconces, cove-lighting, neon signage, soffit lights directed at entrances and store window displays and Tivoli lights trimming the architectural elements, are all recommended for this district.
- Within this district, all vertical projections utilized within the storefront design or signage should employ wall washes and/or recessed neon for emphasis.
- Lighting should be employed within any awnings that are used in this district.

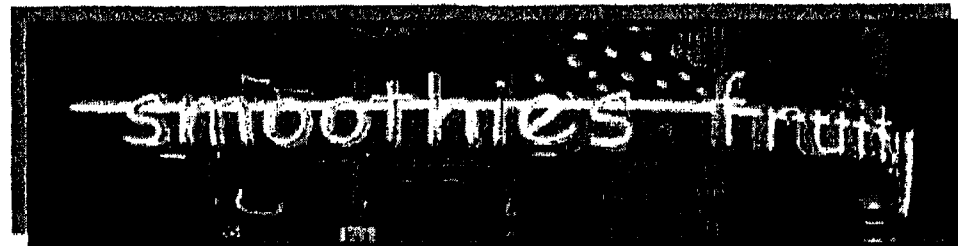

Neon is recommended for use within the Central Plaza District

2.d. The Inner Village District

The Inner Village District is largely comprised of the interior portions of Long Beach CityPlace. This area also includes the project's link to an existing Promenade, a pedestrian feature established through several city blocks within downtown Long Beach.

Building upon the existing Promenade's pedestrian and landscaped theme, the Inner Village District will convey a "garden-like" character, leading to the two landscaped plazas located within the project.

Tenants will be encouraged to employ planters, planter-boxes, trailing vines, potted and hanging plants and decorative trees within their storefront design.

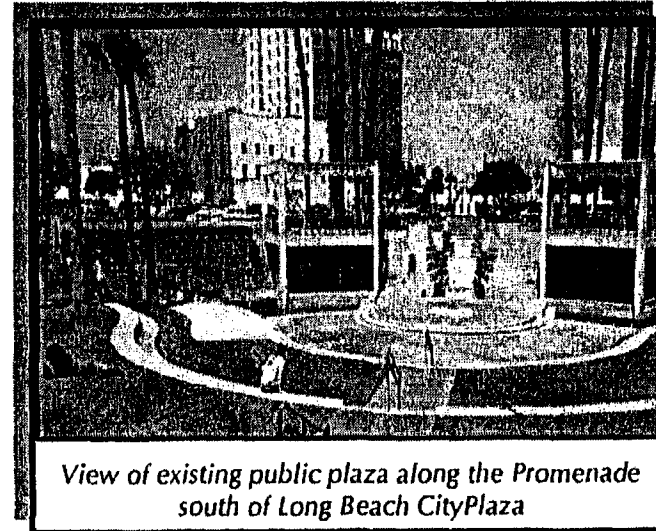

View of existing public plaza along the Promenade south of Long Beach CityPlace

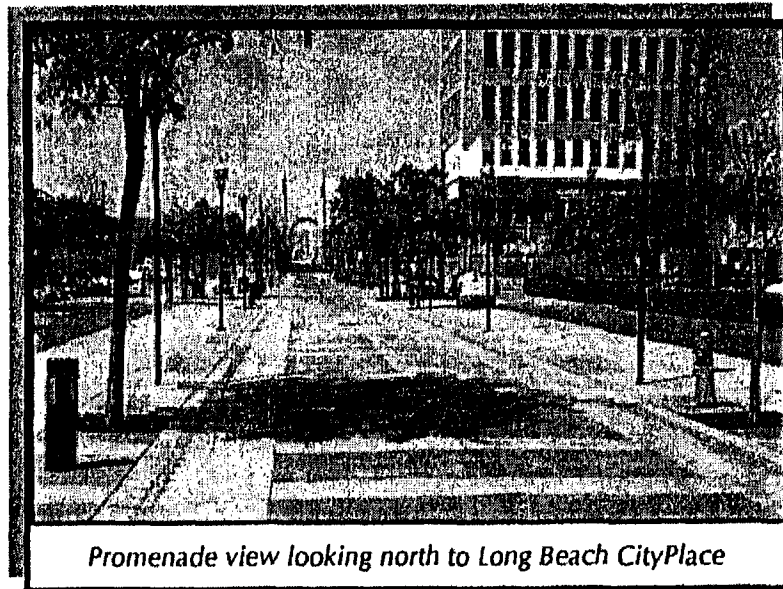

Promenade view looking north to Long Beach CityPlace

District Traits

- Storefronts: Recessed, multi-paned storefronts, transoms, and awnings are encouraged.
- Base: Minimum 18" base required, with decorative planters.
- Detailing: Reminiscent of Art Deco period.
- Colors: Muted "garden-like" colors (i.e., tan, brown, taupe, green)
- Finishes: natural, stained, or baked enamel.
- Signage: Portray a natural or garden theme, utilizing 3-dimensional graphics.

LONG BEACH CITYPLACE

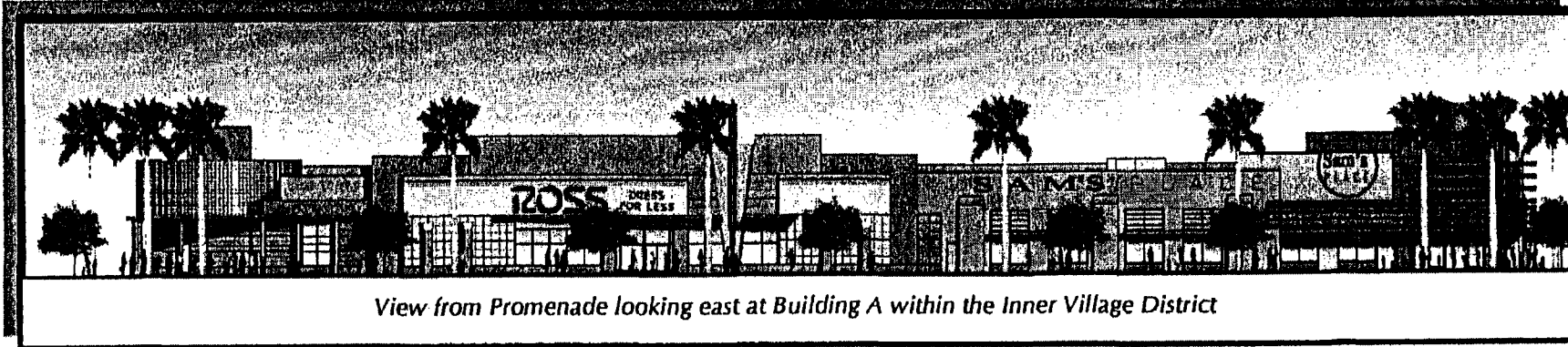

View from Promenade looking east at Building A within the Inner Village District

Storefront Criteria:

- Refer to Tenant's L.O.D. package for space-specific storefront heights and the conditions and parameters of the Tenant's Design Control Zone.
- Storefronts within the Inner Village District should be constructed of painted (baked-enamel) aluminum, in muted colors appropriate to a garden theme.
- Tenants are encouraged to incorporate recessed pockets and other design features that break the continuity of the storefront plane along the promenade.
- Transoms and multi-paned storefronts are encouraged.
- A min. 18-inch storefront base is strongly encouraged to reinforce the urban street concept. Recommended base finishes are rough-hewn stone or natural-finish tiles.
- Where appropriate, sidewalk seating may be provided by the tenant. Exterior furniture to be used by the Tenant (i.e. tables, chairs, trash receptacles, umbrellas,

fireplaces, etc.) should be of high quality, and are subject to final approval from the Landlord.

- Framed doors utilizing ornamental hardware are strongly encouraged. Frameless, all glass (Herculite) doors are prohibited.

Prohibited within Storefront:

- Primary colors, except in cases where they are an integral component of the Tenant's logo are discouraged

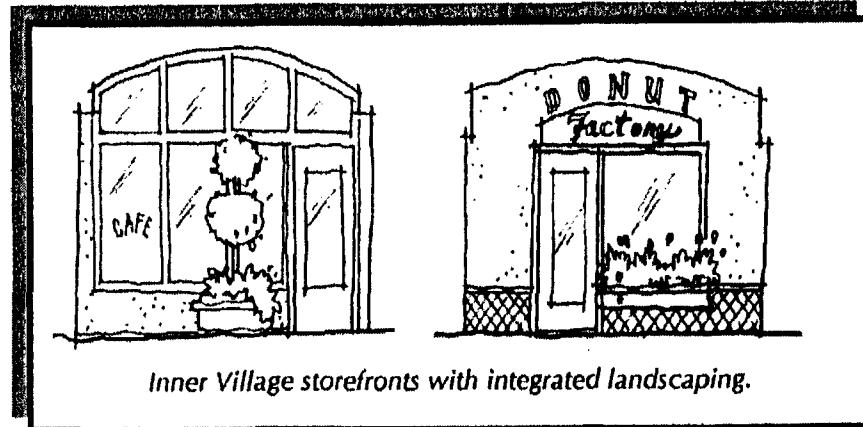

Inner Village storefronts with integrated landscaping.

LONG BEACH CITYPLACE

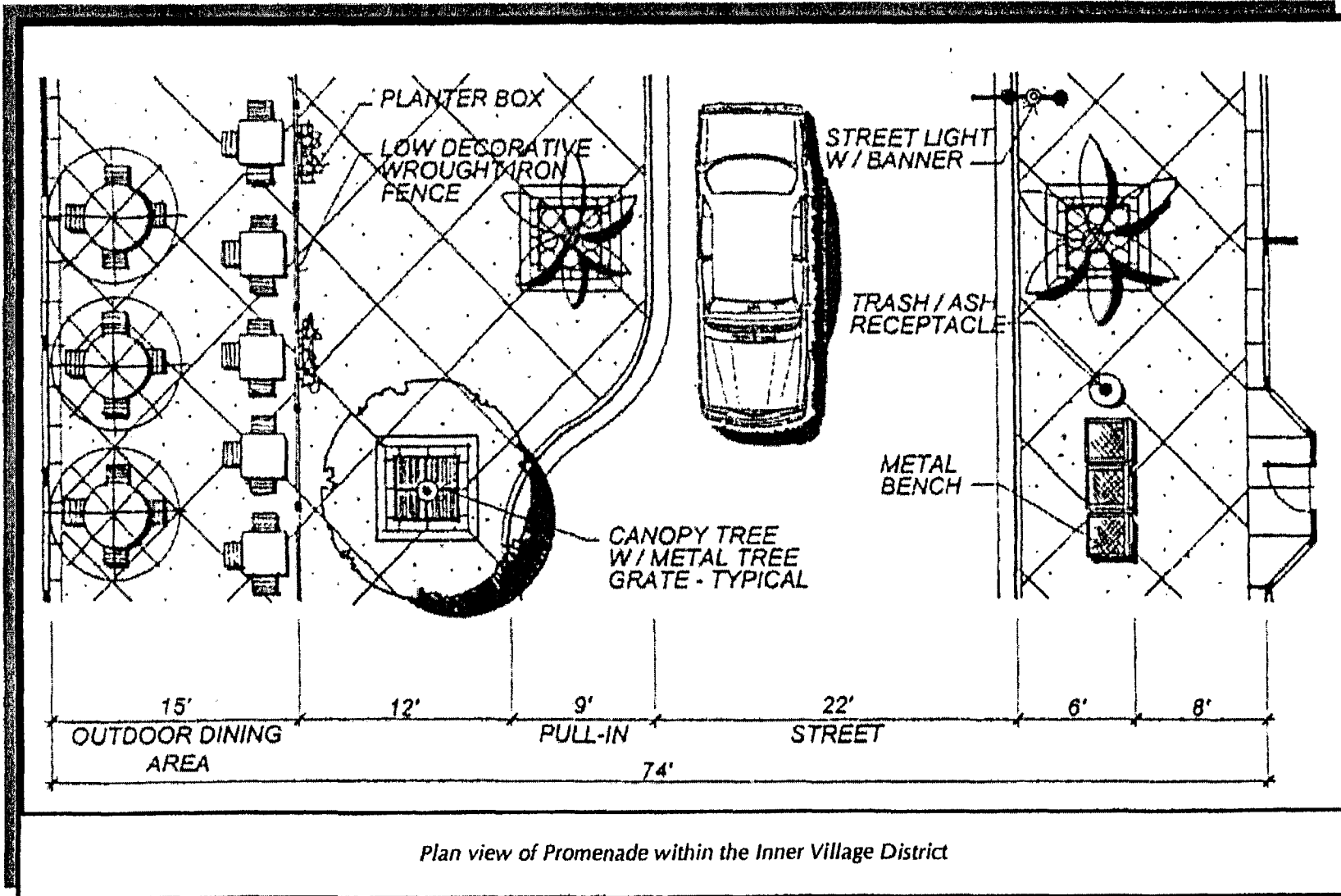

Plan view of Promenade within the Inner Village District

LONG BEACH CITYPLACE

Awnings and Banners:

- Awnings will be encouraged within the Inner Village District, and should be utilized to break down the scale of larger storefronts.
- Horizontal louvered projections will be encouraged within the Inner Village District, and should be utilized to break down the scale of larger storefronts.
- Awnings with clean lines and straight horizontal edges are encouraged.
- Fabric awnings must be constructed of code-approved materials. Refer to local code restrictions to avoid possible sprinkler requirements.
- When awnings are used, under-lighting must be provided.
- Vertical banners are encouraged within the Inner Village District. The maximum horizontal projection from the vertical face of storefront is 24 inches. The bottom of the banner must clear 7'-6" A.F.F.



Examples of awnings
and canopies within
the Inner Village
District

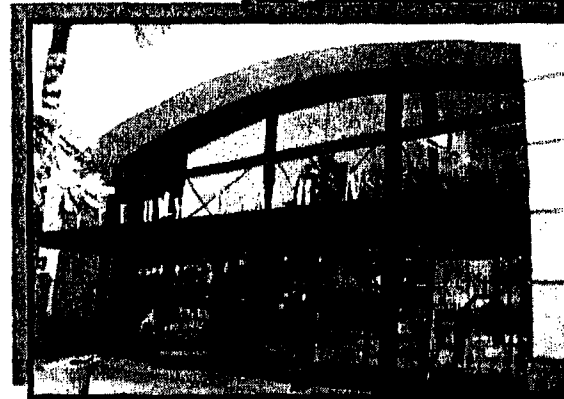

Signage:

- Signage that portrays a natural or garden theme is recommended within the Inner Village District.
- A minimum of one Primary sign and one Blade sign is required.
- All vertical projections utilized within the storefronts in this district should employ wall washes and/or recessed neon for emphasis.
- Signage incorporated onto awnings, horizontal canopies or vertical projections is encouraged for use in this district.
- Wherever possible, sign design and graphics that are reminiscent of the Art Deco period are recommended within the Inner Village District.
- Sign design employing 3-dimensional characteristics is encouraged within the Inner Village District.

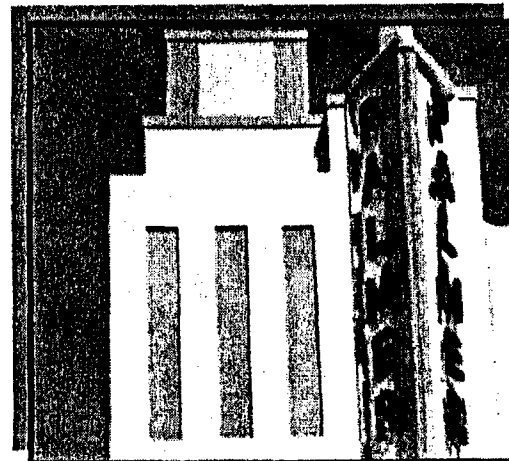
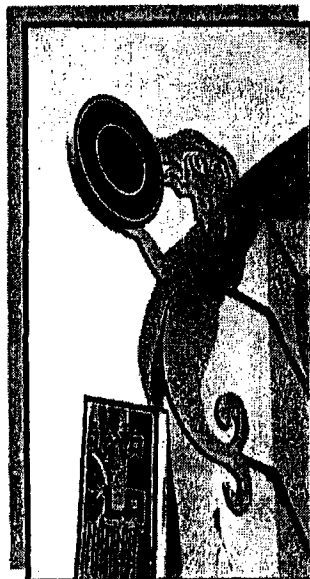

Examples of Primary, Projecting and Blade signage for the Inner Village District

LONG BEACH CITYPLACE

Lighting:

- The Inner Village lighting concept is soft, to characterize a "garden-like" tranquility.
- Specialty light fixtures reminiscent of the Art Deco period are recommended within the Inner Village District when used in exterior locations (i.e. wall sconces.)
- A variety of night-lighting methods should be utilized to guide pedestrians after dark. Tree and planter lights, wall sconces, cove-lighting, soffit lights directed at entrances and store window displays, neon halo lights and Tivoli lights trimming the architectural elements, are all recommended for this district.
- Within this district, all vertical projections utilized within the storefront design or signage should employ wall washes and/or recessed neon for emphasis.
- Lighting should be employed within any awnings that are used in this district.

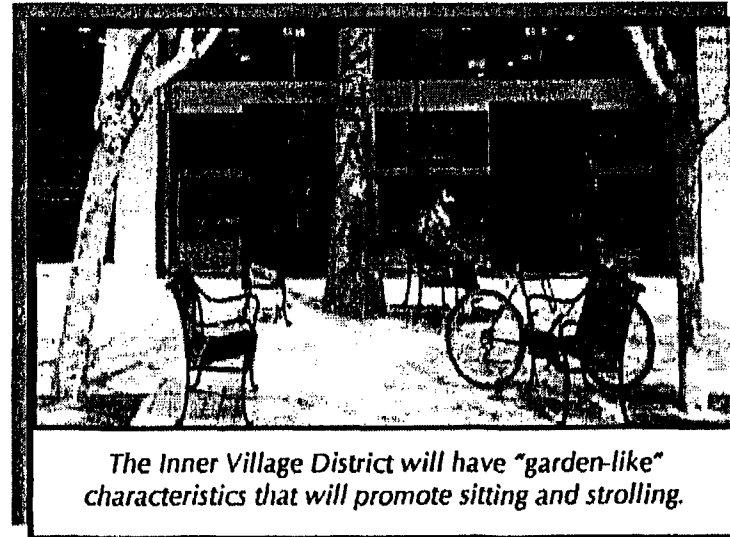

LONG BEACH CITYPLACE

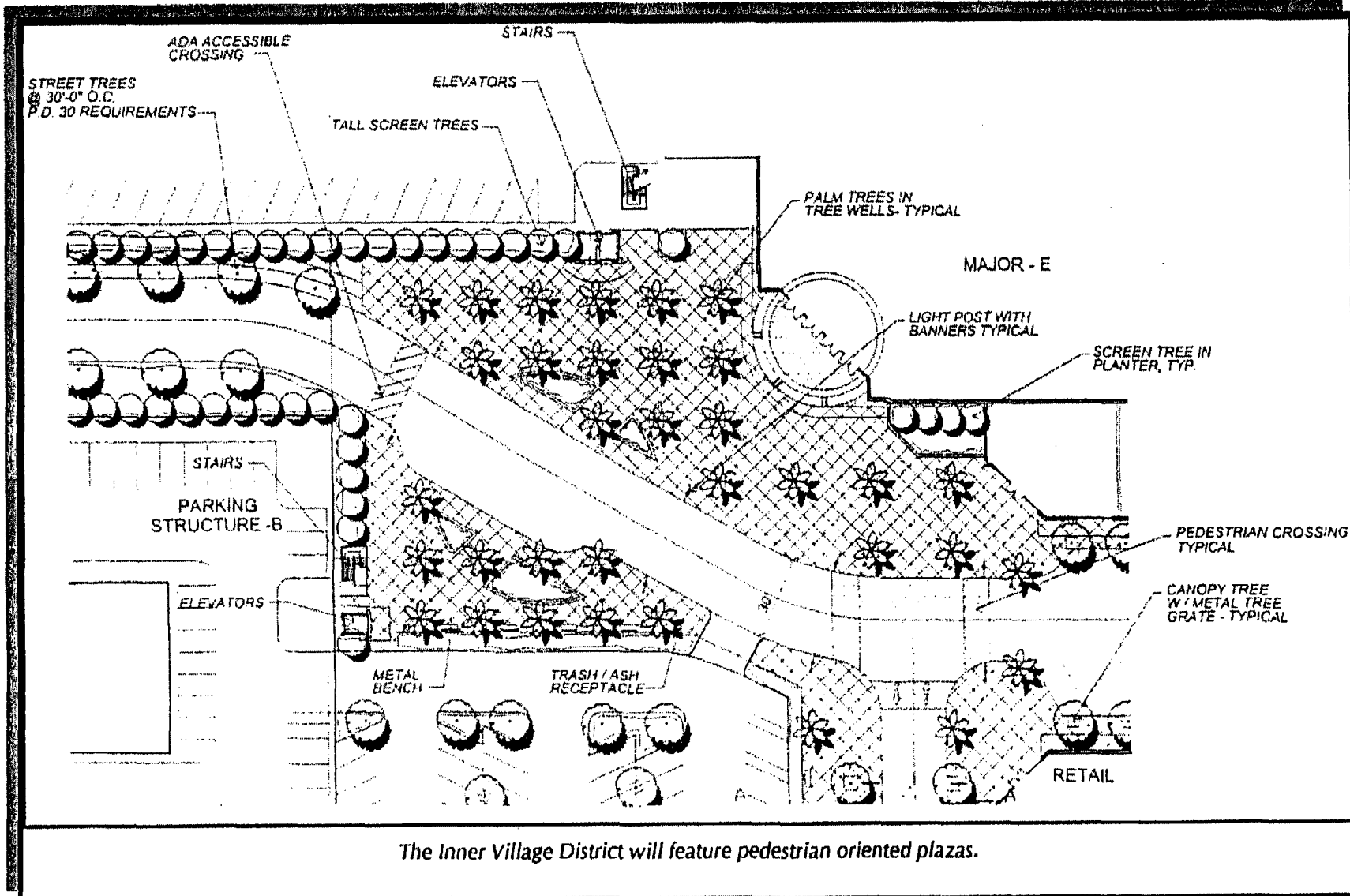

2.e. Long Beach Boulevard District

The Long Beach Boulevard District runs north south along the eastern side of Long Beach CityPlaza. The boulevard is wider than the other streets that border this project, and it is visible to more vehicular traffic.

The "urban" theme will be characteristic along the Long Beach Boulevard District, allowing for a streamlined image, incorporating "cutting-edge" features reflective of the district's activity and motion. Tenants will be encouraged to design storefronts and signage that are crisp in their design, using more metallic and polished finishes.

District Traits:

- Storefronts: "Urban" theme, sharp, "cutting-edge" designs
- Base: Minimum 18" base required, utilizing high-gloss finishes, metallics, polished stone or tile
- Detailing: Crisp, Art Deco Details.
- Colors: Whites, blacks, or darker muted colors (no pastels).
- Finishes: High-gloss or polished, baked enamel paint on aluminum
- Signage: "Up-scale" character.

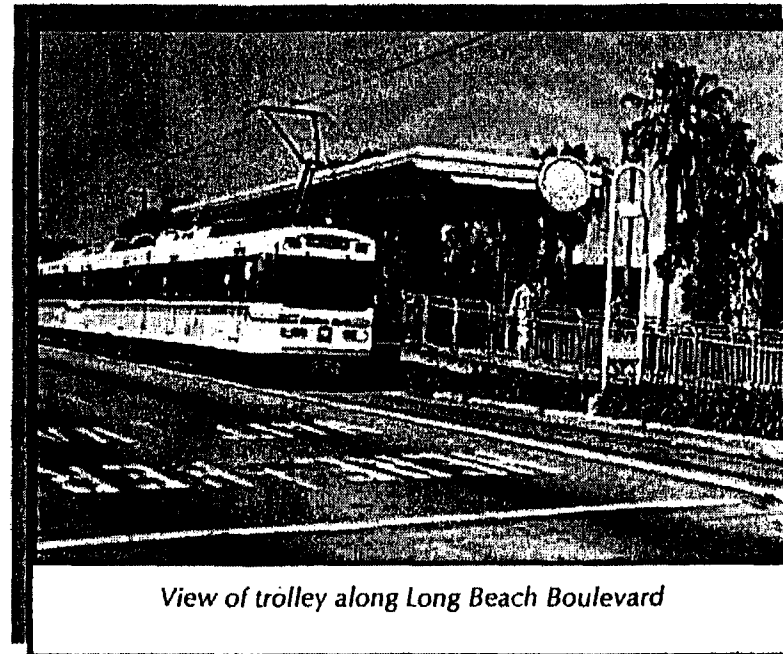

View of trolley along Long Beach Boulevard

Storefront Criteria:

- Refer to Tenant's L.O.D. package for space-specific storefront heights and the conditions and parameters of the Tenant's Design Control Zone.
- Storefronts within the Long Beach Boulevard District should be constructed of brushed or painted (baked-enamel) aluminum, white, black or muted colors. Light pastels are discouraged
- Multi-paned windows are discouraged along Long Beach Boulevard.
- Tenants are encouraged to reduce the scale of long storefronts with recessed entries or display windows.

- A minimum 18-inch storefront base is strongly encouraged to reinforce the urban street concept. Recommended base finishes are metals, tile, or polished stone.
- Where appropriate, sidewalk seating may be provided by the tenant. Exterior furniture to be used by the Tenant (i.e. tables, chairs, trash receptacles, umbrellas, fireplaces, etc.) should be of high quality, and are subject to final approval from the Landlord.
- Tenants will be encouraged to utilize door and door hardware detailing that is crisp in design and reminiscent of the Art Deco period.

Prohibited within Storefront:

- Primary colors, except in cases where they are an integral component of the Tenant's logo, should be avoided.

Awnings and Banners:

- Awnings will be encouraged within the Long Beach Boulevard District, and should be utilized to break down the scale of larger storefronts.
- Horizontal louvered projections will be encouraged within the Long Beach Boulevard District, and should be utilized to break down the scale of larger storefronts.
- Awnings with clean lines and straight horizontal edges are encouraged; scalloped edges are prohibited.

- Fabric awnings must be constructed of code-approved materials. Refer to local code restrictions to avoid possible sprinkler requirements.
- When awnings are used, under-lighting must be provided.
- Vertical banners are encouraged within the Long Beach Boulevard District. The maximum horizontal projection from the vertical face of storefront is 24 inches. The bottom of the banner must clear 7'-6" A.F.F.

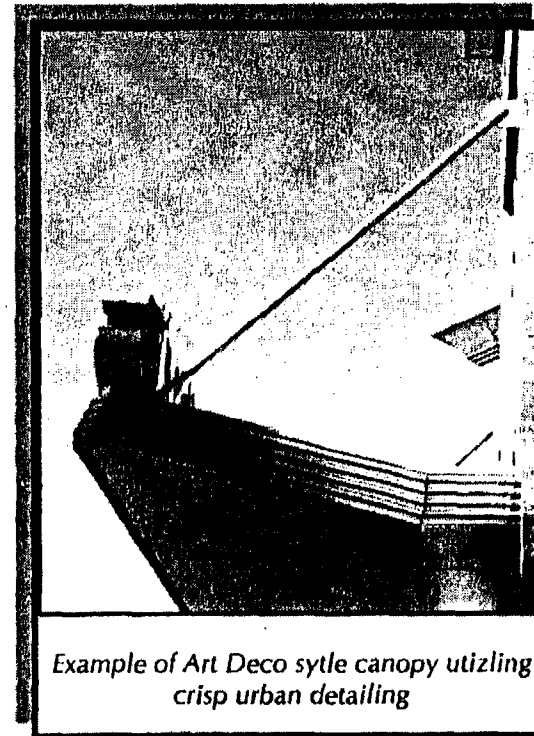

Example of Art Deco style canopy utilizing crisp urban detailing

Signage:

- Signage within the Long Beach Boulevard District should convey an up-scale, urban character.
- A minimum of one Primary sign is required.
- All vertical projections utilized within the storefronts in this district should employ wall washes and/or recessed neon for emphasis.
- Signage incorporated onto awnings, horizontal canopies or vertical projections is encouraged for use in this district.
- Wherever possible, sign design and graphics that are reminiscent of the Art Deco period are recommended within the Long Beach Boulevard District.

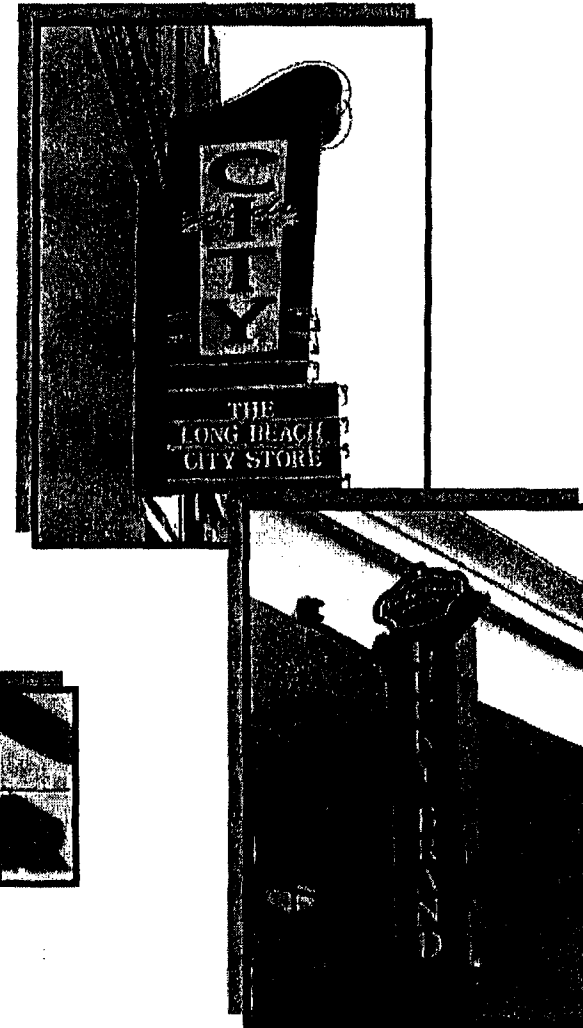

Examples of signage that would be appropriate for the Long Beach Boulevard District

Lighting:

- The Long Beach Boulevard lighting concept is urban and contemporary in character.
- Specialty light fixtures reminiscent of the Art Deco period are recommended within the Long Beach Boulevard District when used in exterior locations (i.e. wall sconces.)
- A variety of night-lighting methods should be utilized to attract vehicular and pedestrian traffic after dark. Wall washes, wall sconces, cove lighting, soffit lights directed at entrances and store window displays, and neon halo are all recommended for this district.
- Within this district, all vertical projections utilized within the storefront design or signage should employ wall washes and/or recessed neon for emphasis.
- Lighting should be employed within any awnings that are used in this district.

2.f. Restaurant Design Criteria

Restaurant tenants are responsible for contacting the Tenant Coordination Team prior to beginning their preliminary design. In addition to the Restaurant Criteria outlined below, Tenant shall also refer to the General Criteria and the appropriate District Criteria. If conflicts arise between the intent of the Restaurant Criteria and the General and/or District Criteria, the latter shall apply.

Restaurant Interiors:

- Restaurant interiors will be evaluated on an individual basis between the restaurant Tenant, Tenant's design representative, and the Tenant Coordination Team. Quality of design, materials, finishes, lighting and furniture (interior and exterior) will be subject to the Landlord's final approval.
- The minimum requirements of all applicable health and building codes must be met in the design of a restaurant.

Restaurant Exteriors:

- The Landlord must approve all outdoor dining amenities.
- Exterior material and furniture to be used by the Tenant (i.e. tables, chairs, portable propane heaters and/or permanent grade-mounted heaters, trash receptacles,

umbrellas, fireplaces, etc.) should be of high quality.

- Exterior storefront-mounted menus are acceptable if no more than 2-sq. ft. in size.
- Tenants who intend to serve alcohol in an outdoor seating area are required to provide an ABC barrier. Each barrier design should be unique to that Tenant while designed to be compatible with the project's overall design character. Solid panel barrier design will not be acceptable, and the integration of landscape within the barrier is strongly encouraged.
- Overhead fabric shade structures or umbrellas may be acceptable, and must be approved by the Landlord. These shading devices must be fabricated of fire-resistant canvas.
- Tenant sound systems that operate with exterior speakers will not be permitted.

2.g. General Signage Design Criteria

The criteria for tenant signage design at the Long Beach CityPlace project falls into two categories; General Criteria, and District Criteria. In addition to the General Criteria outlined within this paragraph, each tenant's signage must also adhere to its applicable District Criteria, which can be found outlined in the following section.

Technical criteria regarding signage can be found within the technical section (Section VI) of this document. All signage must conform to the City of Long Beach standards. A copy of the City Long Beach Sign Code can be obtained from the Landlord's Tenant Coordination Team.

The objective of the sign design criteria is to provide standards and specifications that assure consistent quality, size, variety and placement for Tenant signage throughout this project. The criteria are intended to stimulate creative invention and achieve the highest standard of excellence in environmental graphic communication.

Signage and graphics at Long Beach CityPlace is an integral part of the project's image and appeal, so the signs must be carefully placed and proportioned to the individual architectural façade on which they are placed. Care in the design and installation of store signs will enhance the customer's appreciation of individual tenants and contribute to the project's success.

General Sign Design Styles: There are many acceptable sign treatments, including a mixed media approach that

combines several different fabrication and lighting techniques. All Tenants should review the sign design recommendations outlined within their particular District Criteria and are strongly encouraged to consider the specific architectural style of their façade.

Additionally, the overall concept of the project, the scale of the proposed sign and the critical viewing angles and sight lines are important when designing appropriate signage and graphics for storefronts. Note that specific locations and surrounding architectural treatments can limit the maximum sign height and length, which might differ from the general guidelines proposed herein. The Landlord reserves the right to approve or reject any proposed sign on the basis of its size and placement.

Encouraged Sign Styles:

- Font and halo illuminated channel letters. Note: pushed through acrylic permitted if successfully used as part of an approved "mixed media" sign.
- Mixed media signs are signs employing two or more illumination and fabrication methods (for example, halo lit reverse channel letters with fiber optic accents). Although simple rectangular cabinets are generally discouraged, mixed media signs may be composed of several elements, one of which may be a cabinet. However, the cabinet sign should not exceed 50% of the total sign area. With the Landlord's approval, complex shaped (i.e. polyhedron) sign cabinets may be used alone if they incorporate dimensional elements such as push-through letters and/or exposed neon.
- Mixed media, three-dimensional signs painted gold, silver or copper leaf.
- Halo illuminated letters; 3" deep minimum
- Channel letter with exposed neon, 2-1/2" deep minimum. Exposed neon will be approved at the sole discretion of the Landlord and should be proposed only if part of the overall tenant design concept.
- Dimensional, geometric shapes; screens, grids, or mesh.
- Etched, polished, patina or abraded materials.

- Sandblasted, textured, and/or burnished metal-leaf faced dimensional letters, pin mounted off of façade.
- Signs mounted to hard canopies, eyebrows or other projecting architectural elements. For example: Prismatic face letter forms with full-facet strokes; Rounded face letter forms with radius faces and eased edges; Layered letter forms with face and liner (letter face must be at least 1" thick, and the liner must be a minimum of 1/2" inch thick); Exposed neon can be used as a graphic accent.

Primary Tenant Identification Signs:

- Tenant is allowed one primary identification sign located above the store entrance. The Landlord reserves the right to have final approval in the decision to locate this sign.
- Tenant's sign size is based upon the leased frontage, as measured in a straight-line from lease line to lease line for each elevation. Tenants are allowed 1.5 square feet of primary sign area per lineal foot of store frontage.
- Specific Tenant locations with building elevations facing multiple exposures may incorporate one additional primary identification sign per exposure, subject to the Landlord's approval.
- The overall width of any sign shall not exceed 80% of any uninterrupted architectural treatment.

- Signs may identify the business name and a minimum generic word description of the service. No product identity or specific service descriptions may be displayed within the primary sign surface.
- Unless treated as the primary identification sign, blade signs, flags, banners and window text sign, where permitted, shall not count against the Tenant's overall square footage allowance.

Projecting Signage:

For some Tenants, the Landlord may require that the Tenant's Primary identification sign be a projecting sign. The size and placement of these projecting signs will vary depending upon the store frontage and location, and will be determined at the sole discretion of the Landlord. Projecting signage will be sized to compliment the architectural elements on which they are placed.

For Major Tenants, signs may project a maximum of four feet four inches (4'-4") from the building and have a maximum height of twenty-four feet (24'-0"). However, the exact size of the individual sign will be determined during the design and submission process, and will be subject to the City of Long Beach and the Landlord's final approval.

Where a projecting sign becomes the Tenant's primary identification sign, the Landlord will permit a secondary storefront sign or marquee sign visible to pedestrians at the level of entry.

For other Tenants where the Landlord will allow projecting signs, the signs may project a maximum of three feet six inches (3'-6") from the building and have a maximum height of (10'-0"). The size of each sign is to be determined during the design and submission process and must complement the architectural style and scale of the building, subject to the sole discretion of the City and Landlord.

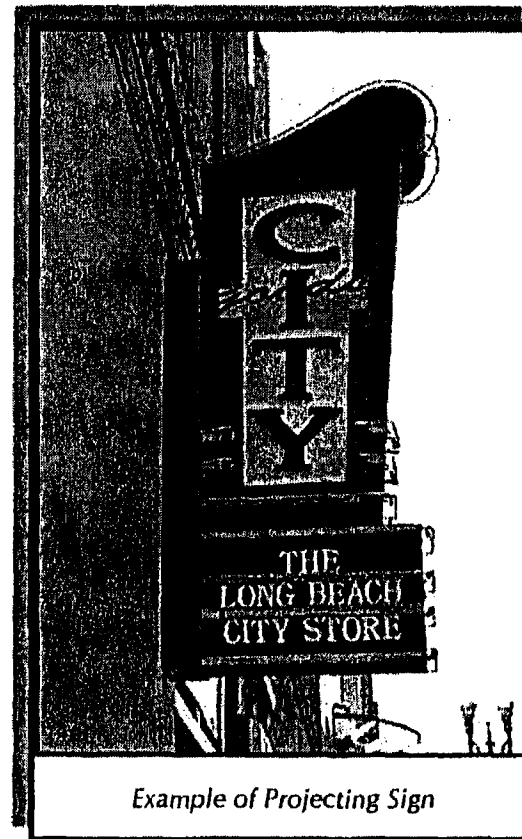

Example of Projecting Sign

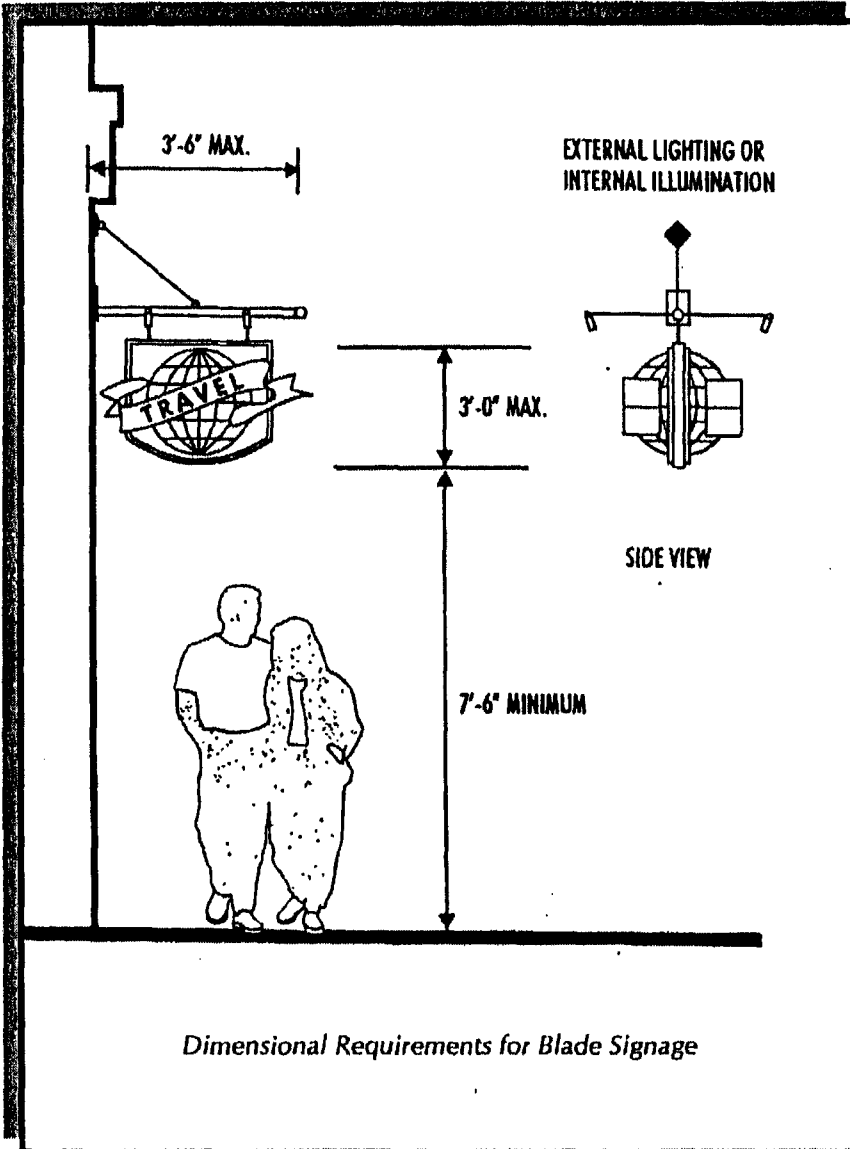

Blade Signage: Each Tenant is permitted one blade sign. The blade sign may feature a three-dimensional or double-faced design. The Landlord encourages the Tenant to propose blade sign designs, which enrich the pedestrian environment strong store name identification.

Illuminated **Blade Signs** are strongly encouraged with either an internal or external light source.

Blade signs shall project no more than three feet six inches (3'-6") from the building face, and shall be no more than three feet (3'-3") in height, with a maximum of 8 square feet of area for each face. Clearance from the underside of the blade sign to the finished common area paving shall be a minimum of seven feet six inches (7'-6").

Proposals for the blade sign designs will be reviewed at the time of the Tenant's overall sign design submission. It is the responsibility of the Tenant to ensure that his fabrication and installation contractor includes adequate support for the blade sign and all associated electrical services and connections.

The blade sign may not be the primary store identification sign and will not be included in the calculation for the overall sign area permitted.

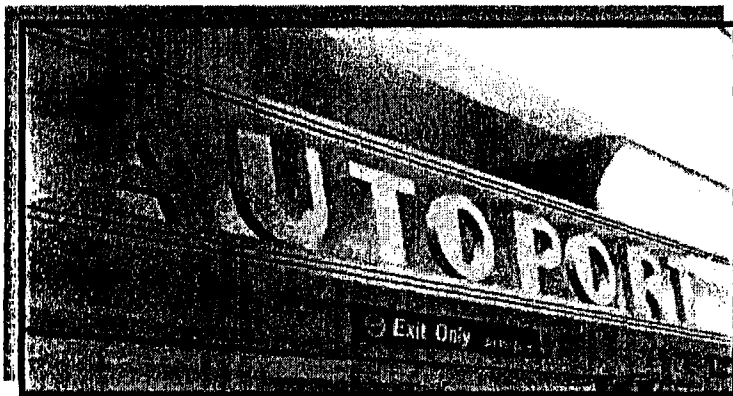

Sign Typeface Styles and Logos: National or regional chain store Tenants shall be permitted to use their standard corporate typography and logos (both must meet the local sign ordinance) which have been used nationwide, provided that these graphics are architecturally compatible and approved by the Landlord. Signage typeface for all Tenants may be arranged in one or two lines of copy and may consist of upper and/or lower case letters. No script lettering shall be permitted unless it is part of the established trademark of Tenant. The Tenant should identify trademark-protected type and marks in their sign submissions to assist the Landlord in the review process.

Where typeface is not pre-determined by Tenant's logo or precedence in similar stores, it is strongly suggested that the typeface selected is reminiscent of the Art Deco period.

Futura Black BT
FUTURA BLACK BT.
Broadway
BROADWAY

Photos at the left and typeface above are representative of suggested Art Deco period type styles.

Sign Colors: The overall project and the individual building façades will both consist of a variety of colors. The Landlord encourages the Tenant to consider their building's colors when choosing their sign colors. Tenants are requested to make early color submissions for review by the Landlord, although final determination of building colors will follow on-site mock-ups and drawdowns reviewed and approved during the construction of the base building shell.

- Signs may incorporate regionally and nationally recognized logo colors.
- Sign colors should be selected to provide sufficient contrast against the building background colors.
- Sign colors should be compatible with, and complement building background colors.
- Sign colors should provide variety, sophistication and excitement.
- Color of letter returns shall match the face of the letter or be a contrasting dark color for enhanced daytime readability.
- Interior of open channel letters should be painted dark when placed against light backgrounds.
- Neon colors should complement related signing elements.

Sign Lighting: Signs which are back-lit, or illuminated by gooseneck lighting are subject to approval of the City of Long Beach and the Landlord. Exposed neon signage and accents shall be subject to approval on an individual basis by the Landlord. Audible, rotating, flashing, or otherwise animated signs are prohibited by the City of Long Beach and are not permitted by the Landlord.

Miscellaneous:

- Window graphic lettering will be permitted with Landlord's approval. These will be limited to text or graphics no larger than five percent (5%) of the overall glass area on which they occur. The text or graphics shall be painted in colors matching the sign colors noted above. No other window signs will be allowed.
- All lamps, cabinets, ballast boxes, supports, transformers, conductors, transformers, conduit (except raceways,) and other equipment shall be concealed. Tenant's sign contractor shall repair all damage to any in-place construction caused by its work.
- All electrical and letter connections (wall penetrations) must be located in mortar joints only.
- All signs and their installation shall comply with all local building and electrical codes and must bear the Underwriters Laboratory label or conform to Underwriters Laboratory specifications.
- Signage shall meet N.F.P.A. 70 ART, 600 Y.

- Electrical service to all signs shall be on Tenant's meter at Tenant's expense.
 - Tenant shall be responsible for the installation and maintenance of all signs.
 - Tenant shall be liable for the operation of Tenant's sign.
 - Tenant's sign contractors shall repair any damage caused by said contractor's work or by its agents or employees.
 - All penetrations of the building structure required for sign installation shall be sealed in a watertight condition and shall be patched to match adjacent finish.
 - Design, layout and materials for Tenant's signs shall conform in all respects with the sign design drawings provided to Landlord for approval.
 - The maximum height and dimensions for letters in the body of the signs shall be pursuant to approved plans and specifications.
- Prohibited Sign Types and Conditions:**
- Unadorned rectangular cabinet signs with translucent or opaque faces.
 - Temporary wall signs, pennants, banners, inflatable displays or sandwich boards, unless specifically approved by the Landlord.
 - Window signs unless approved by the Landlord (Note: box signs hanging in display windows are not allowed).
 - Gold leaf treatments on windows, and limited use of exposed neon in widow displays will be allowed (subject to Landlord approval).
 - Exposed junction boxes, wires, transformers, lamps, tubing, conduits, raceways or neon crossovers of any type.
 - Signs using trim-cap retainers that do not match the color of the letter and logo returns (polished gold, silver or bronze trim caps are not permitted).
 - Pre-manufactured signs, such as franchise signs, that have not been modified to meet these criteria.
 - Paper, cardboard or Styrofoam signs, stickers, or decals hung around or behind storefronts.
 - Exposed fasteners, unless decorative fasteners are essential to the sign design concept.
 - Simulated materials such as wood grained plastic laminates or wall coverings.

- Flashing, oscillating, animated lights or lights or other moving sign components, except as specifically approved by the Landlord.
- Rooftop signs or signs projecting above roof lines or parapets.
- Signs or mansard roofs or equipment screens.
- Advertising or promotional signs on parked vehicles.

Signage Overview: The overview of the above sign criteria is to assist the Landlord, Tenant, and City process.

The landlord will be responsible to:

- Provide base building design and construction information requested by tenant's sign design consultant.
- Expedite the review, revision and approval of tenant sign submissions.

In return the Tenant will be responsible for:

- Design, fabrication, permitting and installation of signs, including any structural support and electrical service and any special installation requiring addition or modification to the shell building approved by the Landlord.

Sign Maintenance: The tenant shall employ sign fabricators and installers approved by the Landlord who are well qualified in the techniques and procedures required to implement the sign design concept.

The tenant will abide by all requirements; guidelines and criteria contained within the Long Beach CityPlace Tenant Design Criteria, and the City of Long Beach Sign Code.

Only those sign types provided for and specifically approved by the Landlord in Tenant's sign submission documents will be allowed. The Landlord may, at his discretion and at the Tenant's expense, correct, replace or remove any sign that is installed without Landlord's written consent, or that is not executed in conformance with the approved submission.

Tenant shall furnish the Landlord with a copy of all sign fabrication permits prior to installation.

3. DIVISION OF WORK

As a general guideline in the preparation of Tenant's plans, this section describes the typical obligations of the Landlord and the Tenant for the design and construction of the premises and further sets forth the division of responsibility for the construction of improvements and the procedures to be followed by Landlord and Tenant.

This outline does not supercede the definitions of Landlord and Tenant's work, which are contained in the executed Lease agreement. All improvements implemented by the Tenant must be approved in advance by the Landlord according to the procedure outlined in the Tenant's lease and this document.

3.a. Landlord

The Landlord has constructed, or will to the extent necessary, construct the following;

Building Shell: That portion of the project consisting of a ground level structure constructed in accordance with local building codes, with exterior design and with materials by, and depending on the location, as determined by the Landlord as follows:

- **Structure**
 - A steel and masonry structure for new construction in accordance with governing codes.

- **Roof**
 - Bituminous roof with tapered insulation.
- **Exterior Walls**
 - Exterior walls of material as determined by Landlord.
 - Exposed interior face of exterior walls of material as determined by Landlord.

Common Areas; The common areas shall have materials as determined by Landlord as follows:

- Hard surface parking lots and striping; access roads; parking lot and traffic signs; lighting and landscaping.
- Hard surface sidewalks and arcade areas
- Design features, such as: bench seating, common area lighting, decorative landscaping, center identification signs, directories, decorative lighting, etc.

Within the Premises: Pursuant to Exhibit C of the Tenant's executed Lease, the following is a description of the construction, and its limitations, to be provided by the Landlord.

- Unsealed concrete slab, with a load capacity of 100psf, with block outs for utilities.
- Vertical neutral surfaces or structural columns separating Tenant storefront construction will be provided. The storefront area will be left open for Tenant construction

between edges of the neutral surfaces and between the arcade or sidewalk's finished floor and the underside of the soffit height, which might vary.

- A tappable minimum four inch (4") sanitary sewer point of connection, to which Tenant shall make it's sanitary connection, will be provided at a point in or adjacent to the premises.
- A tappable, valved, minimum one and one half inch (1 ½") size, cold-water point of connection will be provided at a point in or adjacent to the premises.
- Sanitary and storm sewer mains serving the building.
- Fire Sprinkler Main - An automatic sprinkler riser and control valve with sufficient coverage to protect building's shell will be provided. Tenant shall, at Tenant's expense, contract with Landlord's approved sprinkler contractor to complete tenant improvements to meet all applicable codes, standards, and ordinances.
- Main Electric Service -To be at central electric service distribution point with an empty meter base and fusible disconnect (120/208 3 phase or 277/480 2 phase, depending on the building location). Consult your lease for specifics. Landlord will provide a main disconnect with an open conduit stubbed to premises. Conduit will be a minimum of two-inch (2") size. Service will be sized based on a connected load of 20 watts per square foot for retail. Excess capacity required by Tenant shall be provided by Landlord at Tenant's expense. Feeder wires, step down transformers, distribution panels, branch circuiting, wiring and other

electrical work within the premises are to be installed by Tenant at Tenant's expense.

- Telephone – Landlord shall provide a one-inch (1") open conduit with pull wire, extended from main telephone distribution area to premises.

3.b. Tenant

As-Is Condition: Certain Leases state that the Tenant takes space in an as-is condition. Accordingly, any upgrades whatsoever that must be performed to the premises to accommodate the new Tenant will be done by the Tenant, at the Tenant's expense. Some work may be required to be completed by the Landlord's approved contractor or directed by the Tenant's General Contractor.

Tenant, at its sole cost and expense, shall provide all remaining improvements necessary, other than those performed by Landlord, as set forth in the above section and the Tenant's Lease Exhibit B. This outline in no way represents the full limit of Tenant's work; rather, it is a general guideline. Tenant improvements shall be completed in accordance with all applicable codes, the procedures and schedule set forth in this document, and shall meet the following guidelines:

Storefront, Signs, and Store Design: The Tenant will be responsible for constructing a complete storefront in the full height of the opening with suitable attachment or termination of construction to the soffit and proper watertight closure against each neutral surface. Tenant is

responsible for repairs or any damage it causes to Landlord's finish materials adjacent to its store (costs taken out of construction deposit, if necessary.)

- Tenants are required to employ high quality materials in the construction of their storefronts to promote high quality design. Metal storefronts shall employ extruded baked enamel sections or a clear anodized finish. No bronze anodized sections will be permitted. Any wood employed shall be kiln dried, mill quality finish. No wood used in the storefront shall serve a structural purpose, and all wood trim pieces shall be attached to metal storefront behind.
 - In some cases, building columns may occur along the Tenant's lease line and are exposed to public view. Tenant shall incorporate these columns into their storefront design.
 - The Tenant's storefront glazing must be clear transparent glass; no tinted, reflective or spandrel glass is permitted. If the Tenant installs transom glass over the storefront awnings, this glazing must be clear and allow visibility into the Tenant's space. All textured, patterned or obscure glazing must be reviewed and approved by the Landlord.
 - Each Tenant is required to install a sign timer to ensure that illuminated signs are operating one (1) hour before, during the open hours, and one (1) hour after the open hours of the center.
- Each Tenant will be required to construct and install a blade sign, conforming to the design specified in this section. The calculated blade sign area must be within the total sign area allowed by the City of Long Beach.
 - **Tenant Suite Numbering Signage**
 - Each Tenant shall furnish and install a suite number address on its storefront above the entry doors. Tenant shall conform to Landlord's uniform suite numbering design and may be required to contract with the Landlord's address signage installer.
 - Four-inch (4") high numerals in the "Broadway" typeface shall be applied to Tenant's interior face of glazing.
 - Numerals shall be gold color paint with shadows of black paint around each numeral.
 - Suite numbers shall be centered over main entry doors.
 - The bottom of the numerals shall be two inches (2") above the doorframe.
 - **Tenant Rear Door Identification Signage**
 - Each Tenant shall furnish and install a rear door Tenant identification panel adjacent to their exterior rear door, located in a position and area approved by the Landlord. Tenant shall conform to Landlord's uniform rear door identification panel design and may be required to contract with the Landlord's address signage installer.

- Sign panels shall be 18" wide by 4" high.
- Panels shall be Plexiglas Dark Brown #2418.
- Typography shall be "Broadway". Tenant's name shall be 1 ½" upper case letters.
- Lettering shall be 3M brand #1807 die cut letters
- Panel shall be centered upon width of rear door and shall be mounted at 4' – 9" above floor.

Design Control Zone: The Design Control Zone is a 10'-0"-deep area extending from the lease line inward and running the full width and full height of the storefront. The Landlord considers this zone an extension of the storefront into the store interior. The flooring, ceilings, lighting and displays shall be treated as a visual window into the merchandising area of the Tenant space.

- All graphics, display fixtures, finish materials and lighting within this area is subject to approval by the Landlord. A sense of style and drama should be established through the use of inventive merchandising, displays, quality materials, and suitable lighting.
- In the Design Control Zone, the Tenant will employ incandescent lighting or halogen fixtures exclusively.
- No mass merchandising (i.e., slat wall, etc.) is permitted in the Design Control Zone.
- Durable flooring materials (i.e., stone, ceramic tile, marble, wood, etc.) are required.

- Vinyl or rubber flooring, carpet tile, carpet or laminate floor products are not permitted in this area.
- Sales counters and/or fixturing may not be located closer than six feet (6'-0") to the lease line.
- The Tenant may not place or maintain any temporary merchandise or rack fixtures for the active sale of merchandise within six feet (6'-0") of any entrance to the premises.
- A hard lid drywall ceiling is required within the Control Zone; suspended acoustical ceiling systems are not permitted.

Wall Construction, Interior Partitioning and Doors: Except for the exterior and other walls identified as being provided by the Landlord, Tenant will design and construct, in accordance with applicable code and Landlord's standard building details, all walls within the premises with metal stud construction. Wood wall framing is prohibited anywhere in the premises. Tenant shall design, engineer and perform all work on walls, partitions, and doors within the premises, other than that to be performed by Landlord under Landlord's work, subject to the following:

- Tenant shall provide all required fire dampers or other suitable protection devices in fire-rated walls, if wall penetration is permitted.
- Where the premises have been previously occupied and Tenant elects to retain existing walls, the existing walls shall be repaired or improved by Tenant to a condition

in which will satisfy the Landlord and current fire rating requirements.

- Penetration of exterior walls by Tenant shall not be permitted except as approved in writing by the Landlord prior to the commencement of such work. If an exterior service door is required, it shall be installed by Tenant at Tenant's expense, with Landlord's written approval.
- All partitions within the interior of the premises shall be of metal stud construction, and shall have gypsum board finish on all sides with taped and spackled joints.
- All columns within the premises, including those in demising walls, shall be furred and finished by Tenant
- Walls defining the premises from other Tenants' premises shall be covered on Tenant's side from floor to the structural deck above with 5/8" Type "X" gypsum board..
- Walls defining the premises from service or exit corridors shall be covered on Tenant's side from floor to the structural deck above with a minimum of two (2) layers of 5/8" thick Type "X" gypsum board.. Roof deck flutes at the top of the wall shall be filled with approved fire safety materials as required. All wall construction shall meet any and all pertinent code and regulatory requirements.
- Landlord may require Tenants having excessive noise levels, as determined by the landloard, to provide sound attenuation at the ceiling and demising walls separating the premises from other tenants.
- Tenant shall provide and install fire stops as required by applicable codes.
- Painting, decoration, paneling or applications of a wall covering shall finish all interior wall surfaces.
- If required by code, Landlord shall provide, at Tenant's expense, one exterior rear service or exit door: insulated hollow-metal, recessed, "B" label, which shall be a minimum of 3'-0" x 7'-0" x 1 3/4" with minimum #18 gauge fire-rated frame. If tenant's layout requires door to be relocated, Landlord's contractor, at Tenant's expense, may perform such work.
- Commercial-grade finish hardware, labeled where required, shall be used throughout. All doors shall have a minimum of one and one-half pair of butts, wall or floor stops, 18" high kick plates, locksets, push-pull plates, and other hardware as required by applicable codes. Entrance doors under 8'-0" in height are prohibited.
- Rear exits of stores may have locksets, but these must open from the inside without a key (classroom lock function). Emergency egress must be possible from the store at all times. The lockset installed on a rear door during construction is temporary for the convenience of Tenant's contractor. Tenant shall install permanent lockset.
- Demising or party walls dividing the premises from the premises of adjacent tenants shall be engineered and constructed by Tenant with metal stud framing and shall run from Tenant slab to the underside of the roof deck

construction. Landlord will provide neutral piers between storefronts of a design, size and material to be determined by the Landlord.

Tenant Floors and Floor Coverings: Floors at grade, if not existing, shall be designed and constructed to meet code by Tenant and shall consist of an approved vapor barrier, 3000 psi concrete, minimum four inches in thickness, reinforced with a 6x6 – W2.9/ W2.9 welded mesh, with a steel-trowel, sealed finish.

- The first Tenant to occupy a space adjacent to other Tenants will extend their concrete slab into the adjacent Tenant space(s) far enough to support the metal stud-demising wall. Landlord is to provide a slab ready surface 8" below the finish floor elevation of a suitable material compacted by Landlord to permit Tenant to complete a poured concrete floor. Tenant must field verify existing fill and compaction requirements.
- The finished floor elevation at the Tenant's store entrance must match exactly the finished sidewalk elevation.
- Concrete used to patch any penetration of the floor slab by Tenant shall match existing floor thickness, and be steel trowel finished flush with top of existing floor.
- Tenant shall provide waterproofing protection consistent with codes and as directed by Landlord.
- In all sales areas, Tenant shall provide commercial grade carpeting, hardwood or parquet floors, quarry tile

or other floor covering materials as approved by Landlord. Tenant shall cover all other areas with suitable floor covering materials. Use of vinyl tile or sheet goods in Tenant's sales area is specifically prohibited. Stained and sealed architectural-colored concrete flooring is permitted in the sales area, however, exposed unfinished concrete flooring is prohibited in all Tenant areas.

- All floor surfaces must comply with the requirements of local codes and the A.D.A. Samples of all flooring materials must be submitted to the Landlord for approval.

Trade Fixtures and Furnishings: Tenant shall provide all new trade fixtures, equipment and furnishings for use in the premises.

- All shelf standards used outside of the Tenant Design Control Zone will be fully recessed, flush with the partition finish material, and will not compromise the fire rating, if any, of the wall.
- If installed, slat-wall and slat-wall liners will have the same finish and colors.
- Light fixtures will be positioned to avoid glare for passing pedestrians.
- Floor-mounted fixtures are permitted when, in the Landlord's opinion, they produce an outstanding and imaginative effect.

Vertical Transportation: Tenant shall provide stairs, ramps, elevators, dumbwaiters, conveyors, moving stairs, railing, and coverings as may be required for the premises for Tenant's store design and use.

Stock Room and Exit Access: Tenant shall meet local building code requirements for exiting through a stockroom. Tenant shall also meet all requirements for general lighting and for emergency lighting requirements for exits through storerooms. If a rear service door is located on a service corridor, the service door must be recessed so as not to reduce the width of the service corridor when the door is opened.

Toilet Rooms: Tenant shall provide Tenant's toilet facilities. Fixtures, stall partitions, specialties (such as toilet room mirrors,) and accessories shall be as required for the premises by any governmental and or other authority having jurisdiction over the premises. Toilet facilities shall be sized as required relative to capacity and shall meet code requirements.

- Ceramic tile or F.R.P. panels are required on toilet room walls to a minimum height of 48" above finished floor.
- A waterproof membrane shall be installed under the tile floor and up all walls a minimum of four inches (4"). This membrane must be a type of rolled membrane (Nobleseal or equal).
- A raised handicap-accessible threshold must be installed at all toilet room doors to retain water spills.

Mezzanines: Upon written approval by Landlord, Tenant may install a mezzanine; however, not all store locations are suitable for the installation of a mezzanine. If a mezzanine is desired, Tenant must provide all necessary structural support with a separate self-supported structural system approved by the Landlord. Mezzanines shall not be supported by the building structure. Sprinkler main locations must be considered when locating mezzanines. The cost of the sprinkler main relocation shall be borne by the Tenant. Exiting egress from the mezzanine must meet local code requirements. Tenant's calculated rent-able floor area will be increased by square footage of any mezzanine area.

Miscellaneous:

- Landlord's electrical contractor, at Tenant's expense, must perform all electrical upgrade work, if required, on Landlord's equipment. Coordinate this requirement with Landlord's designated representative.
- The Landlord does not provide ceilings within the premises. Certain structural elements, project piping, and ductwork may reduce clear height. Tenant shall have the responsibility for verification of clear height.
- Location of Landlord's work for the building and within the premises shall be at the Landlord's discretion. Landlord shall have the right to locate both vertically and horizontally, and alter, maintain, and repair utility lines, air ducts, flues, duct shafts, drains, sprinkler mains, and valves and such other facilities within the

premises, as deemed necessary by Landlord. Landlord's right to locate these facilities within the premises shall include facilities required by, or for, any other Tenant or Tenants. It shall be the Tenant's responsibility to provide access panels in its finish work, where required by the Landlord.

- The Tenant, and its architect and engineers, is responsible for field verification of existing and as-built conditions within the Tenant's premises for the purposes of coordinating the Tenant's work with the Landlord's shell work prior to Tenant's construction. The Tenant or the Tenant's Representative, shall conduct a site inspection of their demised premises prior to the submission of preliminary construction documents.
- Only new, materials and fixtures shall be used in the finishing of the premises. Copies of material test certificates must be filed with all agencies and the Landlord prior to occupancy of the premises.
- The loads imposed by Tenant's work, including dead and live loads and merchandise loads, shall not exceed the allowable capacity of existing structural systems and components thereof. Tenant shall be responsible for determining the allowable capacities and for all costs associated with it. The Tenant shall pay for the cost of investigation of Landlord's structure by Landlord, when required due to suspect excessive loading by Tenant.
- Standard Project Details, as issued from time to time by Landlord's architect and as they pertain to Tenant's

work, shall govern Tenant's work. Tenant shall incorporate such details into its working drawings for the premises.

- Prior to the commencement of construction by Tenant, building and other permits shall be obtained by Tenant at Tenant's expense and posted at the premises as required. Copies of the permits must be delivered to Landlord's designated representative.
- Landlord's written approval shall be obtained by Tenant prior to the undertaking of any construction work which deviates from the working drawings, as approved by the Landlord, or the undertaking of any modifications whatsoever to Landlord's building shell or structural components or to the utilities supplied by Landlord or any other work not explicitly shown on said working drawings. Landlord's approval of the foregoing shall not constitute the assumption of any responsibility by Landlord for the accuracy or sufficiency thereof or for their consistency with applicable codes, and Tenant shall be solely responsible thereof.
- The Tenant's design professionals shall certify compliance with all applicable codes. It is the Tenant's responsibility to further ensure compliance with all relevant codes, obtain all approvals, and pay all fees in connection the Tenant's work.
- The design for the Long Beach CityPlace project, Tenant spaces, and site shall undergo review by the project developer, Coventry Long Beach Plaza, LLC, herein referred to as "Landlord".

- As design and construction of the project progress and these designs evolve, the Landlord may issue revised Design Criteria and Construction Details.

4. TECHNICAL REQUIREMENTS

4.a. Heating, Ventilation and A/C:

Tenant's heating, ventilation and air conditioning (HVAC) shall be designed and installed in accordance with the design criteria included herein, and all local requirements. No tenant's work shall be installed prior to having been approved by Landlord and all jurisdictional governmental bodies. The HVAC systems, calculations, designs and installations shall be as recommended in ASHRAE Publications and the Landlord's Design Criteria. Tenant's systems shall meet all applicable codes and ASHRAE standards. Tenant shall furnish Landlord with complete heating/cooling load calculations, including information as to Tenant's lighting load in watts, and Tenant's estimated store population (employees and customers). The heating and air conditioning system installed by Tenant serving the premises shall be as hereinafter described.

- Landlord to install roof mounted AC Units sized to provide 1 Ton capacity/350 rent-able square feet for retail space. Units installed with duct plenum stubbed to premises. Where residential units may be constructed over retail demised premises, a split system shall be utilized with a roof top mounted condenser and fan coil located below in the tenant space. (Includes split-system refrigeration lines) All distribution ductwork, electric service, thermostat, condensate drain piping and drain receptor shall be installed by tenant. The Landlord shall have final approval for any structural revision.

- Tenants, other than food service establishments, shall provide five percent (5%) more outside air than is exhausted to maintain a positive air pressure within the premises, where applicable by code.
- Tenant shall not install any air intakes, relief or exhaust openings through exterior walls. All roof openings, including framing, flashing and roof repairs, shall be made by Landlord at Tenant's expense.
- All components and equipment shall be provided with access for ease of maintenance and service. Provide a minimum of six feet (6'-0") clear around all sides of equipment or the minimum prescribed by manufacturer for maintenance, service and air circulation, whichever is greater.
- All exhaust and plumbing vents must be a minimum of twenty feet (20'-0") from any outdoor air intake.
- All existing conditions shall be field verified by the Tenant or Tenant's design professionals. Discrepancies shall be reported to the Landlord's designated representative for resolution before any work begins.
- Install toilet room exhaust at ventilation rate complying with applicable codes and landlord's drawings (exhaust ducts for toilets shall be extended through the roof in Landlord's designated chase, if provided).
- Balance the air supply and exhaust systems prior to operating, at Tenant's expense (upon completion of Tenant's work, three [3] copies of the test report shall be furnished to Landlord for review and must be approved

before occupancy). A certified contractor shall perform the test and balancing.

- Provide fire dampers as required.

Air Distribution: Provide a complete air distribution system for the HVAC requirements. Provide all required components, such as ductwork systems, diffusers, registers, dampers, etc.

- All air systems shall be low pressure, as defined in the ASHRAE Guide. All ductwork shall be galvanized sheet metal and insulated. All supply, return and outdoor air shall be designed, constructed and installed, as recommended by ASHRAE and SMACNA.
- The Tenant's air distribution system shall provide adequate air motion to all portions of the premises. All conditioned areas shall have even temperature distribution without excessive air motion.
- Diffusers, registers and grilles shall be of the adjustable type for volume and direction.
- Provide document-volume dampers at all branch take-offs and duct tees.
- Air diffusers, registers and grilles shall be designed to coordinate with the general construction and architectural treatment of the finished spaces. Exposed components shall be given a factory-baked enamel or anodized finish. Air diffusers and grilles shall be mounted in frames so the devices may be easily

removed for maintenance and repair whenever the ceiling is constructed of gypsum board.

- Ductwork shall be sized for a maximum friction of 0.10 inches of water column per 100 feet of duct at design airflow. Duct velocity shall not exceed 1,500.00 feet per minute.

Controls: Tenant must install complete temperature control package to operate tenant's HVAC equipment.

Exhaust System: Restaurant tenants, pet shop, beauty salons, barber shops and any other occupancies which, in the sole opinion of Landlord, produce odors, shall provide an exhaust system, which shall prevent such odors from entering the other tenant spaces or any other portion of the Common Areas. Where possible, Tenant shall construct a separate interior room to handle odor-bearing services and /or equipment. Tenant shall, when installing new HVAC unit(s) or equipment:

- Pipe the condensate drain, in accordance with code, so that it is drained into the Tenant's sanitary sewer drain system. In all instances Tenant will be responsible for insuring that all installations meet with all applicable codes and Landlord requirements.
- Ceiling exhaust fans shall be direct-driven centrifugal with insulated metal housing, back-draft damper, internal isolators, and wall or roof cap, complete with bird and insect screen. Maximum noise level rating of

the unit shall be six (6) ones. Interlock toilet exhaust fans with the room light switch.

- Install separate exhaust system(s) if odors, excessive heat, moisture, smoke, or other air contaminants, including but not limited to those by food service facilities, beauty salons, or pet shops, emanate from the premises, and where directed by Landlord. All such exhaust system shall comply with NFPA standards, applicable codes, and Landlord's drawings.

Miscellaneous Requirements

- All mechanical plans and specifications shall carry the embossed seal and signature of a registered professional engineer in the State of California.
- All show-window or display-window areas shall be adequately ventilated.
- The Tenant must wire all items of HVAC equipment. See electrical section and specifications
- All Tenant HVAC plans, calculations and specifications shall be approved by the jurisdictional government authorities and Landlord prior to beginning work. All HVAC work will be inspected throughout the construction process and completion for compliance with the tenant HVAC specifications and code requirements.
- Submit to the Landlord's Tenant Coordinator one separate set each of HVAC air flow and balancing calculations, and prints, for Landlord's records.

4.b Plumbing

All plumbing work shall be installed in accordance with all local requirements and Landlord's tenant plumbing criteria. Landlord's approval of Tenant's plans is not a statement of compliance with any code requirements. Tenant's work includes, but is not limited to, the following;

Sanitary Sewer: Landlord shall provide slab block-out with access to one (1) 4" sewer line within the premises at a location designated by Landlord. Tenant shall design and install all facilities and extensions of service in accordance with the following:

- All underground piping and all main pipes shall be service-weight cast iron. Branch drainpipes shall be service-weight cast iron.
- Tenant shall install accessible clean-outs, as required by applicable code and Landlord's requirements, and they shall terminate flush with the finished floor or wall.
- Tenant shall backfill all trenches required for drainage piping using sand or crushed rock compacted in six inch (6") layers to at least 95% maximum density.
- Tenant shall complete concrete slab, where removed by Tenant for installation of sewer piping. Sub-grade, where disturbed, shall be replaced with six inches (6") lean concrete. A vapor barrier of the same type as provided by Landlord shall be provided. Slab shall be

four inches (4") thick, 3000 psi concrete, reinforced with 6" x 6" x W2.9/W2.9 welded wire mesh.

- All food tenants shall have access to pre-cast units available for common use by multiple tenants. A block-out for access to one 4-inch grease line will be provided within premises. Increased capacity or under-sink traps, if allowed by code, are the responsibility of the Tenant.
- Beauty salons and barbershops shall furnish and install combination hair-and-solids interceptors equal to Josam H40Q, 18" wide x 16 1/2" high.
- Pet shops or pet departments shall install combination hair-and-solids interceptors equal to Josam H40Q, 18" wide x 16-1/2" high.
- All tenants must provide floor drains in toilet, wet areas, and kitchens. Local codes shall govern; however, a minimum of one (1) floor drain in each area shall be required.

Domestic Water: Landlord shall provide a domestic water line connection for the premises at or near the boundary of the premises. Tenant shall design and install all extensions and facilities within the premises in accordance with the following:

- All domestic water piping shall be Type-L copper with soldered fittings using 95/5 tin-antimony solder. Provide dielectric fittings for connections between dissimilar piping.

- Tenant shall install shock absorbers in piping system to prevent noise and damage due to water hammer. All branch piping shall have accessible service valves.
- Tenant shall insulate domestic hot and cold water piping with 1" thick insulation with non-combustible U.L. rated vapor-barrier jacket. Horizontal runout piping within a plumbing chase shall not require insulation.
- Tenant shall be responsible for providing water heaters sized for plumbing requiring hot water. Heaters shall be electric operated and shall conform to all applicable codes.
- Tenant shall be responsible to provide backflow prevention at all water supply connections as required by all applicable codes.
- Roof vents shall be only at locations approved by Landlord and penetrations, flashing and roof repairs shall only be made by Landlord's roof contractor, at Tenant's expense.

4.c. Gas and Electric

Service distribution manifold shall be located at a centralized location in building. All gas distribution piping to be provided by the Tenant. The exact location of gas runs is subject to Landlord's approval.

Restaurant Tenants shall arrange for natural gas service directly with utility company. Tenant shall provide gas

meter and all piping from meter to gas equipment at Tenant's expense.

The Tenant shall provide, at Tenant's expense, all necessary electrical equipment and wiring within the Tenant space, as well as to the Landlord's electrical facilities. Main electric services is 277/480V 3-phase, 4-wire and 120/208v 3 phase, depending on building location, and is available from the Landlord's exterior meter banks (consult individual lease documents). The Landlord has provided switchboards designed for the Tenant's future installation of minimum 200 Amp self-contained meter fittings and service-rated circuit breakers. The Tenant shall provide the meter (to be installed in the Landlord's meter socket) and the conductors between the meter bank and the tenant space. The Landlord shall provide a minimum of one empty 2" conduit between the Landlord's electric/meter room to the Tenant's demising line, or as per the Lease agreement. Tenant electrical equipment shall include, but not be limited to, the following:

- All interior distribution panels, lighting panels, power panels, transformers, conduits, outlet boxes, switches, outlets, and wires within the premises. Tenant shall provide electric conduit and boxes in the concrete floor slab, ceiling and walls, including all electrical service panels, pull boxes and equipment, as required to permit Tenant to construct his work as outlined herein.
- All systems, where required for intercommunication, music, burglar alarm, vault wiring, fire protection alarm system, time clock and demand control. Coordinate meter requirements with Landlord's representative.
- Dry-type transformers as may be necessary to accommodate Tenant's requirements.
- Lighting and distribution panel boards required to service all electric loads in, or used in conjunction with, the premises.
- All temporary and permanent lighting, power, and signal outlets; lighting fixtures with lamps; emergency lighting, branch circuit wiring, and all electrical equipment required in, or associated with, the premises. All wiring and fixtures in the ceiling plenum shall conform to applicable code requirements for a ceiling return air plenum. All wiring shall be installed in conduit.
- All other electrical systems in the premises that may be required by Tenant for systems such as security, sound, intercom, etc.
- All breakers must be bolted breakers and switch-rated. All panels, panel schedules, and controls shall be fully identified and labeled, typed and in protective plastic sleeving.
- Before work commences, it is Tenant's responsibility to verify that the Landlord's existing electrical service is of adequate size to service the Tenant. Upon approval by the Landlord of any modification needed to modify the Landlord service to accommodate the Tenant's design,

the Landlord's approved electrical contractor, at the Tenant's expense, will perform the modifications.

- All fixtures within the Premises must be approved by the Landlord and shall conform with the following criteria:
- All conductors are to be copper in conduit.
- Keep all piping as close to walls and as high to underside of roof framing as possible.
- All stores shall be designed with a night light circuit. The night light circuit shall have a lock tab on its circuit breaker.
- Provide an emergency lighting system and exit signs to conform to local requirements. All emergency lights and exit signs shall have battery backup.
- Roof penetrations for rooftop equipment electrical wiring shall be within 30" of the curb or penetrate through the curb into the unit. Landlord's roofing contractor, at Tenant's expense, will perform any and all roof penetrations.

Each set of Tenant electrical drawings shall include the following:

- Complete load calculations provided on the form titled, "Electrical Load Summary Data", to verify demand requirement.

- Complete single-line drawings showing all main protective devices, panels, transformer/ switches, HVAC loads, conduit size, quantity and size of conductors.
- Complete individual panel schedules with breaker sizes and poles, loads, etc.
- Complete fixture schedule with fixture description and quantity and type of lamps.
- Complete symbol list.

4.d. Ceilings

Tenant's ceiling work includes all work related to ceiling treatments including light coves, soffits, fascias, dropped ceilings, acoustical treatment, ornamental specialties, and other related items. Refer to specific criteria.

- Tenant ceilings shall be of non-combustible construction, and shall be gypsum board or acoustical tile of concealed suspension type or a regular type regressed-metal grid lay-in type incorporating a 2' x 2' regular type acoustical tile. Standard 2' x 4' grid systems shall only be permitted in stock areas not visible to the public. Other ornamental or acoustical tile ceilings may be permitted subject to Landlord's prior written approval. Drywall ceilings are required in the Design Control Zone. All ceiling materials must be class "A".
- Ceilings shall be of the accessible type, or access panels shall be provided to allow Landlord access to base

building equipment. Coordinate with Landlord's Tenant Coordination Team.

- Furring, framing, and blocking shall be of non-combustible materials that meet all code requirements.
- If an existing expansion joint occurs through the Tenant space, the Tenant is responsible for the construction of the ceiling affected by that joint in a manner consistent with acceptable construction design practices.
- Tenant's ceiling must align with, or be located above, top of storefront at front of Tenant's demised premises. When storefront is over 12'-0" in height, ceiling must maintain the increased height.

4.e. Structural

Any alterations, additions or attachments to Landlord's structure to accommodate Tenant's work shall not be performed, without in each instance, the prior written approval of the Landlord and building department inspectors. Tenant shall leave Landlord's structure as strong or stronger than the original design and with finishes unimpaired.

- No welding to building structure shall be permitted.
- Roof penetrations required by Tenant and approved in writing by Landlord (cutting of roof deck and deck material and the repair of the same) shall be performed, repaired, and maintained by Landlord's designated roofing contractor, at Tenant's expense. All work shall

be done in accordance with the Standard Project Details shown in the L.O.D. provided.

4.f. Lighting

Landlord-provided project exterior illumination will not provide adequate lighting for storefront merchandise within the Tenant Control Zone. Tenants are required to install lighting in the Design Control Zone, including recessed soffit lighting, floor-mounted up-lighting, track lighting, or other lighting approved by the Landlord.

- Fluorescent fixtures are not permitted in the Tenant Control Zone.

Tenant's Interior Lighting Criteria: If fluorescent ceiling light fixtures are used, they must be recessed and incorporate metallic-finished parawedge diffusers, or their equivalent. Maximum fixture size is four square feet (2' x 2').

- The average maintained candlepower should be no less than sixty-five (65) foot-candles.
- White acrylic egg-crate diffusers and clear acrylic prismatic diffusers are not permitted.
- T-8 fluorescent lighting systems with electronic or energy-saving ballasts are to be used; old technology T-12 fluorescent fixtures are not permitted.
- Direct visual exposure of incandescent bulbs and/or fluorescent tubes is prohibited.

- High intensity discharge (H.I.D.) lamps, i.e., mercury vapor, sodium, or metal halide, are not permitted.
- Theatrical strobe, spinner, or chase type lighting devices are not permitted anywhere in the premises.
- Luminous ceilings, chandeliers, wall brackets or glitter strips may be used only if the Tenant has established an identity based on this theme or motif, and must be approved by the Landlord.
- All showcases and display cases must be adequately lit and ventilated.
- Track-type lighting must be compatible with the design of the Tenant space; surface or pendant-mounted track light fixtures may be used.

4.g. Telephone

The Tenant is to make arrangements with the Telephone Company and provide all telephone system panels, outlets, and conduits in the premises and wire to the distribution point outside the premises. All telephone wire in the ceiling shall be installed to conform to applicable code requirements for a ceiling return-air plenum.

4.h. Fire Protection

Tenant's Systems: Codes and governing authorities require fire sprinkler protection for the premises. Landlord shall provide a sprinkler main. Tenant shall, at Tenant's expense, contract with Landlord's approved sprinkler contractor to complete the automatic sprinkler system to

include cross mains, branch lines, control valves, arm-overs, drops, water flow indicators, drains, test valves, orifices or other fire protection equipment (e.g., fire alarm system components, fire extinguishers, etc.) as may be required for the premises, all of which shall comply with the requirements of Landlord's fire casualty insurer, all applicable codes, standards and ordinances, all referenced, National Fire Protection Association (NFPA) standards (e.g., NFPA 13) the applicable insurance Service Bureau, the local Fire Department, and Landlord's drawings, whichever is more stringent. Tenant's system shall also be hydrostatically tested in accordance with NFPA 13 in the presence of local fire department and the Landlord's designated representative.

- Using Landlord's approved sprinkler contractor, the Tenant shall develop shop drawings of new or modified sprinkler systems and present sepia reproducible drawings of same, with appropriate hydraulic calculations, to the local Fire Department for approval prior to commencing work.
- Two sets of city approved reproducible shop drawings must be filed with Landlord, prior to commencement of construction activity, for the Landlord's records and the Landlord's insurance underwriter's records. Upon completion of the work, signed copies of the appropriate contractor's material and test certificates found in NFPA 13, shall be filed with all agencies and the Landlord prior to occupancy of the premises.

- If Tenant's occupancy requires increases in Landlord's automatic sprinkler main lines or underground water service, Tenant shall be responsible for all costs of providing the upgrading of the system to meet local requirements.
- It is intended that each shell multi-tenant building be divided into zones, and each zone's devices (document pull stations, audiovisual devices, etc.) will annunciate to a zone addressable device fire control panel at the rear of the zone where zone flow and tamper switches will also be provided. One dedicated remote signaling station will be provided from each zone control panel to a receiving station specified by the Long Beach Fire Protection District.
- It is intended that security key boxes (knox box) approved by the fire department will be provided at the zone fire protection control station with adequate tenant space keys and/or master keys for fire personal entry.
- All sprinkler heads in the Design Control Area (drywall ceiling) at the storefront must be fully recessed with blow-off caps (i.e., concealed-type sprinklers). Sprinkler heads in sales areas must be fully or semi-recessed.
- Tenant shall provide smoke detectors in accordance with NFPA 90A, Section 4-4.
- Tenant will install one strobe/horn device in an approved weatherproof housing above the front entrance of each tenant space. This device will be connected to the water flow valve for the tenant space and will annunciate upon discharge of the sprinkler system within Tenant premises.
- Any damage to Landlord's sprinkler system caused by Tenant's work will be repaired by Landlord at Tenant's expense.
- Automatic sprinkler equipment shall be tested by Landlord's designated contractor and placed in service affording fire protection for the premises before occupancy is allowed. The introduction of stock, furniture, fixtures, equipment, or other combustible material to the premises is prohibited until automatic sprinkler system is approved by the local Code authorities and Landlord and is placed in service. The premises are to be kept free of combustible materials and trash generated by construction activity must be removed from the premises daily. Combustible enclosures (gang boxes) for contractor's tools and storage are not permitted.
- Landlord's fire insurance underwriter shall, from time to time during the term of the Lease, have the right to inspect the fire protection systems. Said system shall at all times comply with the requirements of said underwriter and shall meet the conditions of its approval and any alterations, improvements, repairs, or maintenance required by such underwriter shall be Tenant's sole responsibility and shall be performed promptly at Tenant's expense, upon notice of such conditions.

- Before any construction begins, fire extinguishers shall be provided and installed in type, number, and locations as required by authorities having jurisdiction.
- Restaurant tenants will comply with special alarms and devices at fume hood locations per governing codes.
- Tenants may be required to provide as-built information in automated form (AutoCad14) for inclusion into the fire departments CADD drawing file for the entire shopping center.
- Landlord's contractor at Tenant's expense, shall repair any damage to the roof caused by Tenant's exhaust system.
- Tenant shall provide and install a round pre-fabricated double-wall duct breaching for other gas-burning (if available) equipment according to HVAC specifications and local code requirements. Coordinate location of flue thru-roof with outside air intake of rooftop units to maintain Landlord and code-required clearances.

Grease Elimination: All restaurant Tenant's kitchen roof-mounted kitchen exhaust equipment shall include installation of grease collection and elimination facilities in accordance with Landlord's drawings, at Tenant's expense. Such facilities shall include, but not be limited to, grease collection pan with a drain connected to Tenant's grease trap, if permitted by local authorities, and a source of hot water on the roof for use in cleaning grease accumulation within such pan. Landlord's roofing contractor, at Tenant's expense, shall perform all roof penetrations.

Grease Interceptors: (Spaces designated for restaurant only) Precast type exterior units are available for common use by multiple tenants. Concrete slab knockout with access to one (1) 4" grease line under slab at premises. Increased capacity or under-sink grease traps, if allowed by code, are the responsibility of the Tenant.

4.i. Restaurant Tenants

Exhaust and Flue: Tenant shall provide and install all exhaust equipment, ductwork, controls, etc. required for complete installations for each toilet room, kitchen hood or as required by the specifications or by the Landlord's designated representative.

- All Tenant exhaust hoods shall be spaced a minimum of twenty (20'-0") feet from any fresh air intake.
- All hoods and filters must be properly serviced and maintained so as not to deposit any grease on Landlord's roof.
- In event that it becomes necessary for Landlord to maintain Tenant's exhaust system, Landlord shall charge back Tenant for the cost of such service.

4.j. Specific Details

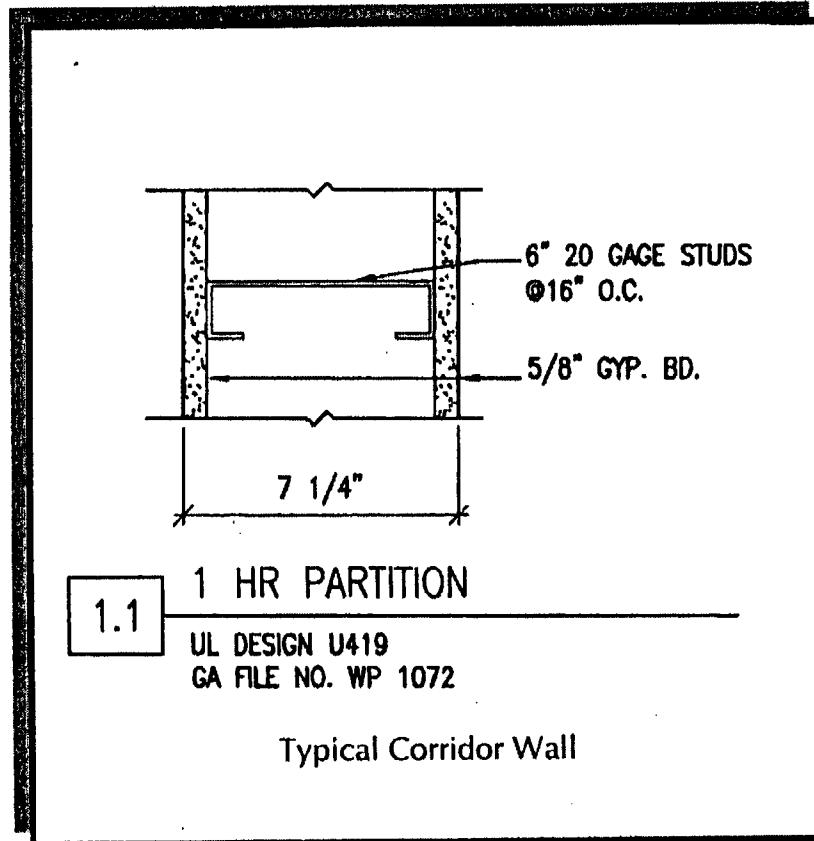
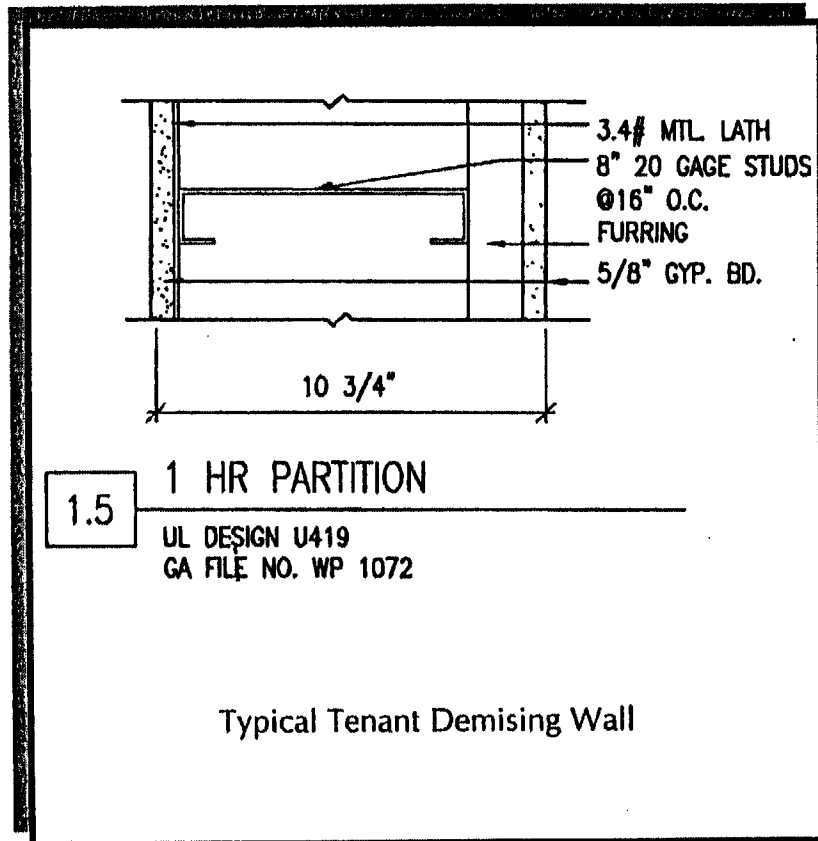

5. TENANT PLAN SUBMITTAL

Preliminary Design Drawings: Within thirty (30) days of receipt of the Tenant LOD package from Landlord, Tenant shall submit to the Tenant Coordination Team three (3) sets (sheet size shall be 24" x 36" or 30" x 42" only) of Tenant's Preliminary Design Drawings showing intended design, character, and finishing of the premises. These drawings shall include:

- Key plan showing exact location of Tenant's lease space.
- Storefront elevation drawings including any graphics and signage and indicating all materials and finishes.
- Cross-sections through Tenant's lease space and section details.
- Floor plan detailing store layout, floor treatments, and merchandise fixture arrangement.
- Reflected ceiling plan detailing ceiling finishes, design and lighting treatments.
- Store merchandise fixture and general lighting cut sheets/specification booklet.
- Storefront signage preliminary shop drawings from Tenant's signage contractor.
- Outdoor seating area layout (when applicable.)
- One professionally prepared color and material sample specification board 8 ½" x 14" maximum size (not

returnable) which identifies floor treatments, wall finishes, merchandise fixture finishes, storefront trims and finishes, etc.

- It is also highly recommended that photographs of completed construction of Tenant's similar stores also be included with the preliminary package.

Aesthetics of the store and its relation to the overall project and other Tenants is a major concern in the approval process. It is mandatory that the Tenant submits the complete information as required above as soon as possible to avoid delay in plan revisions and/or construction. Upon receipt of all items required by Landlord, the Landlord's Tenant Coordination Team shall review Tenant's preliminary design drawings.

Within fifteen (15) days after receipt of the Tenant's preliminary design drawings, Landlord shall return to Tenant one (1) set of prints of preliminary design drawings marked either "No Exception Taken", "Rejected", "Make Corrections Noted", or "Revise and Resubmit of Submit Specified Items". Preliminary approval made in good faith does not restrict Landlord from further comments on the final construction documents.

If the Preliminary Design Drawings are returned to Tenant marked Revise and Resubmit and/or Make Corrections Noted, said drawings shall be revised immediately by Tenant and resubmitted to Landlord for review within fifteen (15) days of Landlord's transmittal to Tenant. This

procedure shall be repeated until the Landlord requires no resubmission.

Should the Preliminary Design Drawing be disapproved, the Tenant shall submit corrected drawings within fifteen (15) days after receipt of disapproval from Landlord. All Tenants are required to have submitted their plans to be reviewed and approved by Landlord's Tenant Coordination Team prior to the start of final working drawings.

Final Working Drawings and Specifications: Within fifteen (15) days after receipt of Landlord's approval of the Tenant's preliminary design drawings, Tenant shall submit two (2) sets of reproducible prints of Tenant's final working drawings to Landlord's Tenant Coordinator for Landlord's final approval. Tenants are required to have their complete plans reviewed and approved by Landlord's Tenant Coordination Team prior to the start of construction.

Within fifteen (15) days after receipt of Tenant's working drawings, Landlord shall review Tenant's working drawings, and notify Tenant as to whether Landlord approves or disapproves said drawings. If Landlord disapproves, Landlord shall set forth the revisions it requires and Tenant, within seven (7) days after receipt thereof, shall make appropriate revisions and resubmit the working drawings to Landlord. Landlord shall then approve or disapprove said revised drawings as set forth herein.

- Working drawings shall be prepared by architectural and engineering professionals licensed in the State of California
- Tenant shall have sole responsibility for compliance with all applicable statutes, codes, ordinances, and other regulations for all work performed by or on behalf of Tenant on the premises.
- Landlord's or Landlord's agent's or representative's, approval of Tenant's working drawings or of Tenant's work shall not constitute an implication, representation, or certification by Landlord that said working drawings or Tenant work is in compliance with said statutes, codes, ordinances, and other regulations.
- In instances where several sets of requirements must be met, Landlord's insurance underwriters or the strictest standard shall apply, where not prohibited by applicable codes.
- Simultaneous with Tenant's working drawing submission, Tenant shall submit one set of reproducible prints and two (2) sets of blue-line prints of engineered sprinkler plans to Landlord's representative, if required, and the Fire Marshall for review and approval.
- Upon completion of Tenant's work and before Tenant opens for business at the premises, Tenant shall submit to Landlord written proof, if required, from Landlord's insurance underwriter, that the fully installed system was approved by said underwriter. Tenant shall submit to Landlord and Landlord's insurance underwriter copies of all material and test certificates.

- Tenant shall use a sprinkler contractor approved by Landlord, at Tenant's expense, to perform all work, prepare all drawings and secure all required approvals.
- Working drawings shall be prepared by Tenant in strict compliance with the Tenant Design Criteria, and shall conform to the preliminary design drawings as approved by the Landlord.
- Where existing equipment or conditions are proposed to be reused, they shall be accurately indicated on the working drawings and are subject to Landlord's approval.

6. PLAN CHECK / PERMIT PROCESS

Tenant shall secure and pay for any and all permits and licenses necessary for the local jurisdictional approval and permitting of Tenant improvements and Tenant's plans. Tenants shall ensure that their contractor will perform all work in compliance with all governing statutes, ordinances, regulations, codes, and insurance rating boards, take out all necessary permits, and obtain certificates of occupancy for the work performed by Tenant, all subject to Landlord's approval.

Building Department: It is the Tenant's responsibility to conform to all applicable statutes, ordinances, regulations and codes, and obtain all necessary licenses and permits for the construction of the Tenant's premises. Specific questions regarding the applicable codes or items within the code and/or permits or permit fees should be directed to the proper authorities. The Landlord or the Tenant Coordination Team does not provide code interpretation, code negotiation or other intervention.

Permit Application: Tenants must comply with the following municipal requirements for the processing of a Building Permit Application:

- Building Permit application shall be completed and submitted by the Tenant's general contractor of each Tenant improvement project.

- Building Permit applications are to include the names/phones of each contractor (bldg., plbg, mech., electrical) and valuation of each contractor's bid with the grand total of project work.
- All contractors are to be licensed with the City of Long Beach prior to issuance of building permit.
- There is a plan check fee required when plans, specifications, and permit applications are submitted to the City. Then at the time of issuance of Building Permit, all fees (bldg./plbg/mech./electric permit fees, plan review fee, use tax deposit) are paid in full.
- Note: Water and sewer tap fees are separate, and must be applied for/paid for prior to issuance of Building Permit.

Submittal of two (2) sets of complete construction plans and specifications prepared (signed, sealed, and dated) by an architect licensed and registered in the State of California.

One (1) additional set of complete plans is to be delivered to the Long Beach Fire Department (attn: Tim Buzbee.). These submittals shall include:

- A site plan, including circulation details in compliance with Accessibility Code.
- Structural drawings, specifications, calculations.
- Architectural drawings and specifications.
- Plumbing drawings and specifications.

- Mechanical drawings and specifications.
- Electrical drawings and specifications.
- Fire Protection drawings, specifications, and calculations.

Separate permits will be issued by the City of Long Beach for Fire Sprinkler, Hose Pipe, Hood and Duct, and other such fire protection systems, following approval of the appropriate Fire Protection Bureau.

Facilities that include food preparation areas will require a permit from the Long Beach Health Department. (562-570-4156) Applicants should contact this department directly and submit a copy of the permit to the City.

Separate permits will be issued by the City for elevators and similar equipment. Drawings and specifications should be submitted to the City for these permits.

Separate permits will be issued for signs. Submit appropriate drawings (colored) and specifications.

The City will use outside consultants for specific reviews or where the volume of the applications requires additional resources. While the review time of these consultants and of other agencies (such as the Fire District, the Health Department, etc.) cannot be guaranteed, the City will attempt to maintain the above schedule.

Building Permit Applications: Applications are available at the City office. Permit applications and plans may be submitted at the City of Long Beach, Development Services Center. If you have any questions, call 310-570-6651 from 7:30 am - 4:30 pm, Monday through Friday except legal holidays.

Health Department: - Prior to the issuance of a Building Permit, all restaurant (food) Tenants must submit complete sets of stamped working drawings and specifications to the Long Beach Health Department for review and approval. Tenant shall coordinate drawing submission requirements with that department.

Handicapped Requirements: - Each Tenant shall verify with the City Building Department the provisions for the handicapped and any ADA requirements as required by City of Long Beach or other jurisdictional authority.

Tenant Package: The Landlord's Tenant Coordination Team will forward to the Tenant a package consisting of these Tenant Design Criteria and a Lease Outline Drawing (LOD). Arrangements can be made with the Tenant Coordination Team to obtain additional Base Building Construction Documents that may be helpful in the preparation of Tenant Improvement plans.

The information provided by the Landlord's Tenant Coordination Team is based on information found in the base building project documents or other existing drawings and/or project specifications prepared by the Landlord's

Project Architect and may not reflect the final as-built field conditions. It will remain, pursuant to the terms of the Tenant's executed Lease, the responsibility of the Tenant (or Tenant's appointed representative Architect, Designer and/or Engineer) to field verify all information pertaining to the premises for the preparation of Tenant Improvement Drawings prior to completion of Tenant's Drawings and/or Construction of Tenant Improvements.

Working Drawings shall be done on 24" x 36" or 30" x 42" size sheets only and shall include, but not be limited to, the following:

<u>ITEM</u>	<u>SCALE (MINIMUM)</u>
a. Key plan showing location of store within premises	No minimum scale
b. Floor and fixture layout	¼" = 1 foot
c. Overall sections	¼" = 1 foot
d. Reflected ceiling plans	¼" = 1 foot
e. Plan, elevation, and section of storefront.	¼" = 1 foot
f. Details of storefront	1-½" = 1 foot
g. Details of special conditions encountered	1-½" = 1 foot
h. Interior elevations	¼" = 1 foot
i. Full sections of types of partitions used	½" = 1 foot
j. Door schedule with jamb details, including list of hardware, room finish schedule	½" = 1 foot
k. Storefront and interior finish and color sample board	Part of Preliminary Design Drawings Submittal (maximum size 8 ½" x 14")
l. HVAC, plumbing, sprinkler plans	¼" = 1 foot
m. Mechanical details	No minimum scale
n. Electrical plans, reflected ceiling plan, lighting plan and circuited power plan	¼" = 1 foot
o. Electrical details, fixture schedules, riser diagram, and phase balanced panel board schedules	No minimum scale
p. Mechanical/Electrical Design Submittal Forms – (Design Submittal Forms shall be incorporated onto Working Drawings).	
q. Sign manufacturers shop drawings	No minimum scale

NOTE: Faxed submittals will not be accepted

7. GENERAL INFORMATION

7.a. Project Directory

Tenant Coordination:

Landlord's Structural:

Owner/Landlord:

lty

Developer:

Construction Manager:

Landlord's Contractor:
Company.

Landlord's Architect:

az

7.b. Plan Check and Utilities Directory

<u>Building Permits:</u>	Building Dept. Long Beach City Hall, 4 th Floor 333 West Ocean Blvd. Long Beach, CA 90802 310-570-6651
<u>Sewer and Water:</u>	Public Works/Utilities Long Beach City Hall, 4 th Floor 333 West Ocean Blvd. Long Beach, CA 90802 310-570-7084
<u>Fire Department:</u>	City of Long Beach Fire Department Long Beach City Hall, 4 th Floor 333 West Ocean Blvd. Long Beach, CA 90802 310-570-7086
<u>Electric & Gas:</u>	Public Works/Utilities Long Beach City Hall, 4 th floor 333 West Ocean Blvd. Long Beach, CA 90802 310-570-7084
<u>Telephone:</u>	800-483-4000

7.c. Jurisdiction and Codes

The Long Beach CityPlace project is subject to the following building construction codes, which have been adopted by the City of Long Beach:

- The 1997 Uniform Building Code
- The 1997 Uniform Mechanical Code
- The 1997 Uniform Fire Code
- The 1999 Uniform Electrical Code
- The NFPA Code (101)
- The 1997 Uniform Plumbing Code
- ANCI 117
- City of Long Beach Sign Code

EXHIBIT E

EXCLUSIVE AND PROHIBITED USES AT CITY PLACE, LONG BEACH, CA

1. Sporting goods business including the sale of sporting goods items, including sports and athletic apparel, athletic shoes and athletic footwear as long as Big 5 Sporting Goods or its successors have a lease at City Place and is operating as a retail sporting goods business. Sales of sporting goods items shall be permitted if they occupy the lesser of 10% of the sales floor area of the premises or two hundred fifty (250) square feet.
2. For the operation of a buffet, buffet-style, cafeteria or cafeteria-style restaurant as long as Hometown Buffet or its successors have a lease at City Place and is operating as a buffet, buffet-style, cafeteria or cafeteria-style restaurant.
3. For the sale of blankets, bedspreads, sheets, towels, pillows, window coverings, table top or kitchen accessories as long as Anna's Linens or its successors have a lease at City Place and is operating as a retail business selling some of the items listed. Sales of such items shall be permitted if they occupy less than 25% of the premises.
4. For retail sale or display of video game software and hardware and computer game software as long as EB Games or its successors have a lease at City Place and is operating as a retail business selling video game software and hardware and computer game software. Sales of such items shall be permitted if they occupy less than 20% of the premises.
5. For sale of athletic branded footwear as long as Footaction or its successors have a lease at City Place and is operating as a retail business selling athletic branded footwear. Sales of such items shall be permitted if they occupy less than 50% of the premises or 50% of the gross sales.
6. For sale of frozen yogurt, ice cream, smoothies, brownies or cookies as long as TCBY/Mrs. Fields or its successors have a lease at City Place and is operating as a retail business selling frozen yogurt, ice cream, smoothies, brownies or cookies. Sales of such items shall be permitted if they occupy less than 40% of the premises.
7. For sale of brand name perfumes as long as Luxury Perfumes or its successors have a lease at City Place and is operating as a retail business selling brand name perfumes. Sales of such items shall be permitted if they occupy less than 10% of the premises.
8. For operation of an internet café and business services center offering internet services, photocopy services, color laser printing, meeting room services, post office ad mailbox services and other similar business services as long as C&C Business Services or its successors have a lease at City Place and is operating as internet café and business services center.
9. For sale of deli and submarine type sandwiches as long as Quizno's or its successors have a lease at City Place and is operating as a retail business selling deli and submarine type sandwiches. Sales of such items shall be permitted if they are less than 20% of the gross sales on the premises.
10. For full service day spa offering facial cleansing services and body wraps as long as Face N Firm or its successors have a lease at City Place and is operating as a retail business as a full service day spa offering facial cleansing services and body wraps.
11. For the operation of laser skin cosmetic procedures and treatments such as hair removal, tattoo removal, skin/facial resurfacing and rejuvenation, varicose/spider veins, acne treatment, scars revision, pigmented lesions, vascular lesions treatment and blepharoplasty and for other skin medical

procedures such as chemical skin peel, microdermabrasion, sclerotherapy, mesotherapy, botox and skin fillers as long as Medispa or its successors have a lease at City Place and is operating as a retail business. The exclusion shall not be applicable to any Occupant that engages in the above activities on only an incidental basis. "Incidental" means that such Occupant does not derive more than twenty percent (20%) of its gross sales from activities above.

12. For the retail display and sale of jewelry made of gold, silver, diamonds, precious and semi-precious gems such as are available at Daniel's Jewelers, Don Roberto, Zales, Sterling Jewelers, White Hall Jewelers and other similar retailers. as long as Daniel's Jewelers or its successors have a lease at City Place and is operating as a retail business. The exclusion shall not be applicable to any Occupant that engages in the above activities on only an incidental basis. "Incidental" means that such Occupant does not derive more than fifteen percent (15%) of its gross sales from activities that are otherwise included within the definition of Exclusive Use or occupy more than 250 square feet of their premises. The Exclusive Use shall not be applicable to any "high end" jewelry such as would be available at a Tiffany & Co., Bailey, Banks & Biddle, Ben Bridge, Cartier, Shreve and other similar retailers or to boutique jewelers such as and similar to Jewels by Joseph.
13. Other than the buildings fronting Pine Avenue, a theater, auditorium, meeting hall, school, church or other place of public assembly (other than a live theatre or performing arts school not in excess of 5,000 square feet), flea market, gymnasium, health club, dance hall, billiard or pool hall, or night club.
14. Sale of guns
15. Any commercial laundry or dry cleaning plant (as opposed to a retail store with incidental onsite laundry)
16. Veterinary hospital
17. Mortuary
18. Operation of a "head shop", so called, or other business devoted to the sale of articles or merchandise normally used or associated with illegal or unlawful activities, such as but not limited to the sale of paraphernalia used in connection with marijuana, cocaine or other controlled drugs or substances
19. Massage parlor, the operation of an establishment whose primary business is the sale of so-called "adult" materials such as, without limitation, magazines, books, movies and photographs
20. Automotive sales, automotive services, automobile body and fender repair work or car-washing facility other than provided by the tenant at the Wal-Mart site
21. Bowling alley, a skating rink, a theatre (other than live performance theatre less than 5,000 square feet), a video or pinball operation
22. Educational, vocational or religious facility including but not limited to, a church, a beauty school or other institution for vocational training
23. Industrial facility, including but not limited to, a manufacturing, warehousing, processing or rendering plant facility
24. Any use or operation that is obnoxious to or out of harmony with the development or operation of a first class promotional shopping center, including, but not limited to:
 - a) any public or private nuisance,
 - b) any noise or sound that is objectionable due to intermittence, beat, frequency, shrillness or loudness,

- c) any obnoxious odor,
- d) Use, storage, transportation, handling, manufacture or emission of any noxious, toxic, caustic or corrosive fuel or gas or other hazardous or toxic substance, except in the ordinary course of business in the ownership, operation or occupancy of a shopping center,
- e) Emission of a microwave, radio wave, or other similar electronic, light or noise radiation at levels which are dangerous to health or which interfere with the proper operation of electronic, telephone, computer or other business equipment of tenants at the Shopping Center,
- f) Any dust, dirt or fly ash in excessive amounts,
- g) Any unusual fire, explosion or other damaging or dangerous hazard,
- h) Any warehouse (other than an area for storage of goods intended to be sold at a retail establishment in the Shopping Center), assembly, manufacture, distillation, refining, smelting, agriculture or mining operations excluding a brew pub,
- i) Any mobile home or trailer court, labor camp, junk yard, stock yard or animal raising (other than a pet shop),
- j) Any above surface drilling for and/or removal of subsurface substances,
- k) Any dumping of garbage or refuse other than in dumpsters or compactors designed for such purpose.

EXHIBIT F
OMITTED

EXHIBIT G
SUBORDINATION, NON-DISTURBANCE AND ATTORNMENMENT AGREEMENT

This Subordination, Non-Disturbance and Attornment Agreement (the "Agreement") is dated as of the ____ day of _____, 200_, between Wachovia Bank, National Association, a national banking association ("Lender"), and _____, a _____ ("Tenant").

RECITALS

A. Tenant is the tenant under a certain lease (the "Lease") dated _____, ____ with _____, a _____ ("Landlord") or its predecessor in interest, of premises described in the Lease (the "Premises") located in a certain **shopping center** known as **CITY PLACE LONG BEACH** located in Long Beach, California and more particularly described in Exhibit A attached hereto and made a part hereof (such shopping center, including the Premises, is hereinafter referred to as the "Property").

B. This Agreement is being entered into in connection with a mortgage loan (the "Loan") being made by Lender to Landlord, to be secured by, among other things: (a) a first mortgage, deed of trust or deed to secure debt on and of the Property (the "Mortgage") to be recorded with the registry or clerk of the county in which the Property is located; and (b) a first assignment of leases and rents on the Property (the "Assignment of Leases and Rents") to be recorded. The Mortgage and the Assignment of Leases and Rents are hereinafter collectively referred to as the "Security Documents".

C. Tenant acknowledges that Lender will rely on this Agreement in making the Loan to Landlord.

AGREEMENT

For mutual consideration, including the mutual covenants and agreements set forth below, the receipt and sufficiency of which are hereby acknowledged, the parties hereto agree as follows:

1. Tenant agrees that the Lease is and shall be subject and subordinate to the Security Documents and to all present or future advances under the obligations secured thereby and all renewals, amendments, modifications, consolidations, replacements and extensions of the secured obligations and the Security Documents, to the full extent of all amounts secured by the Security Documents from time to time. Said subordination is to have the same force and effect as if the Security Documents and such renewals, modifications, consolidations, replacements and extensions thereof had been executed, acknowledged, delivered and recorded prior to the Lease, any amendments or modifications thereof and any notice thereof.

2. Lender agrees that, if the Lender exercises any of its rights under the Security Documents, including an entry by Lender pursuant to the Mortgage or a foreclosure of the Mortgage, Lender shall not disturb Tenant's right of quiet possession of the Premises under the terms of the Lease so long as Tenant is not in default beyond any applicable grace period of any term, covenant or condition of the Lease.

3. Tenant agrees that, in the event of a foreclosure of the Mortgage by Lender or the

acceptance of a deed in lieu of foreclosure by Lender or any other succession of Lender to fee ownership, Tenant will attorn to and recognize Lender as its landlord under the Lease for the remainder of the term of the Lease (including all extension periods which have been or are hereafter exercised) upon the same terms and conditions as are set forth in the Lease, and Tenant hereby agrees to pay and perform all of the obligations of Tenant pursuant to the Lease.

4. Tenant agrees that, in the event Lender succeeds to the interest of Landlord under the Lease, Lender shall not be:

(a) liable for any act or omission of any prior Landlord (including, without limitation, the then defaulting Landlord), except to the extent such act or omission of the prior Landlord is an ongoing non-monetary default under the Lease which is reasonably susceptible to cure by Lender, or

(b) subject to any defense or offsets which Tenant may have against any prior Landlord (including, without limitation, the then defaulting Landlord), or

(c) bound by any payment of rent or additional rent which Tenant might have paid for more than one month in advance of the due date under the Lease to any prior Landlord (including, without limitation, the then defaulting Landlord), or

(d) bound by any obligation to make any payment to Tenant which was required to be made prior to the time Lender succeeded to any prior Landlord's interest, or

(e) accountable for any monies deposited with any prior Landlord (including security deposits), except to the extent such monies are actually received by Lender, or

(f) bound by any surrender, termination, amendment or modification of the Lease made without the consent of Lender.

5. Tenant agrees that, notwithstanding any provision hereof to the contrary, the terms of the Mortgage shall continue to govern with respect to the disposition of any insurance proceeds or eminent domain awards, and any obligations of Landlord to restore the real estate of which the Premises are a part shall, insofar as they apply to Lender, be limited to insurance proceeds or eminent domain awards received by Lender after the deduction of all costs and expenses incurred in obtaining such proceeds or awards.

6. Tenant hereby agrees to give to Lender copies of all notices of Landlord default(s) under the Lease in the same manner as, and whenever, Tenant shall give any such notice of default to Landlord, and no such notice of default shall be deemed given to Landlord unless and until a copy of such notice shall have been so delivered to Lender. Lender shall have the right to remedy any Landlord default under the Lease, or to cause any default of Landlord under the Lease to be remedied, and for such purpose Tenant hereby grants Lender such additional period of time as may be reasonable to enable Lender to remedy, or cause to be remedied, any such default in addition to the period given to Landlord for remedying, or causing to be remedied, any such default. Tenant shall accept performance by Lender of any term, covenant, condition or agreement to be performed by Landlord under the Lease with the same force and effect as though performed by Landlord. No Landlord default under the Lease shall exist or shall be deemed to exist (i) as long as Lender, in good faith, shall have commenced to cure such default within the above referenced time period and shall be prosecuting the same to completion with reasonable diligence, subject to force majeure, or (ii) if possession of the Premises is required in order to cure such default, or if such default is not susceptible of being cured by Lender, as long as Lender, in good faith,

shall have notified Tenant that Lender intends to institute proceedings under the Security Documents, and, thereafter, as long as such proceedings shall have been instituted and shall be prosecuted with reasonable diligence. In the event of the termination of the Lease by reason of any default thereunder by Landlord, upon Lender's written request, given within thirty (30) days after any such termination, Tenant, within fifteen (15) days after receipt of such request, shall execute and deliver to Lender or its designee or nominee a new lease of the Premises for the remainder of the term of the Lease upon all of the terms, covenants and conditions of the Lease. Lender shall have the right, without Tenant's consent, to foreclose the Mortgage or to accept a deed in lieu of foreclosure of the Mortgage or to exercise any other remedies under the Security Documents.

7. Tenant hereby consents to the Assignment of Leases and Rents from Landlord to Lender in connection with the Loan. Tenant acknowledges that the interest of the Landlord under the Lease is to be assigned to Lender solely as security for the purposes specified in said assignments, and Lender shall have no duty, liability or obligation whatsoever under the Lease or any extension or renewal thereof, either by virtue of said assignments or by any subsequent receipt or collection of rents thereunder, unless Lender shall specifically undertake such liability in writing or unless Lender or its designee or nominee becomes, and then only with respect to periods in which Lender or its designee or nominee becomes, the fee owner of the Premises. Tenant agrees that upon receipt of a written notice from Lender of a default by Landlord under the Loan, Tenant will thereafter, if requested by Lender, pay rent to Lender in accordance with the terms of the Lease.

8. The Lease shall not be assigned by Tenant, modified, amended or terminated (except a termination that is permitted in the Lease without Landlord's consent) without Lender's prior written consent in each instance.

9. Any notice, election, communication, request or other document or demand required or permitted under this Agreement shall be in writing and shall be deemed delivered on the earlier to occur of (a) receipt or (b) the date of delivery, refusal or nondelivery indicated on the return receipt, if deposited in a United States Postal Service Depository, postage prepaid, sent certified or registered mail, return receipt requested, or if sent via a recognized commercial courier service providing for a receipt, addressed to Tenant or Lender, as the case may be, at the following addresses:

If to Tenant:

with a copy to:

If to Lender:

Wachovia Bank, National Association
Commercial Real Estate Services
8739 Research Drive URP - 4, NC 1075
Charlotte, North Carolina 28262
Attention: Portfolio Management

with a copy to:

Kilpatrick Stockton LLP
Hearst Tower, Suite 2500
214 North Tryon Street
Charlotte, North Carolina 28202
Attention: John Nicholas Suhr, Jr., Esq.

10. The term "Lender" as used herein includes any successor or assign of the named Lender herein, including without limitation, any co-lender at the time of making the Loan, any purchaser at a

foreclosure sale and any transferee pursuant to a deed in lieu of foreclosure, and their successors and assigns, and the terms "Tenant" and "Landlord" as used herein include any successor and assign of the named Tenant and Landlord herein, respectively; provided, however, that such reference to Tenant's or Landlord's successors and assigns shall not be construed as Lender's consent to any assignment or other transfer by Tenant or Landlord.

11. If any provision of this Agreement is held to be invalid or unenforceable by a court of competent jurisdiction, such provision shall be deemed modified to the extent necessary to be enforceable, or if such modification is not practicable, such provision shall be deemed deleted from this Agreement, and the other provisions of this Agreement shall remain in full force and effect, and shall be liberally construed in favor of Lender.

12. Neither this Agreement nor any of the terms hereof may be terminated, amended, supplemented, waived or modified orally, but only by an instrument in writing executed by the party against which enforcement of the termination, amendment, supplement, waiver or modification is sought.

This Agreement shall be construed in accordance with the laws of the state of in which the Property is located.

The person executing this Agreement on behalf of Tenant is authorized by Tenant to do so and execution hereof is the binding act of Tenant enforceable against Tenant.

Witness the execution hereof [under seal] as of the date first above written.

LENDER:

WACHOVIA BANK, NATIONAL ASSOCIATION

By: _____

Name:

Title:

TENANT:

By: _____

Name:

Title:

The undersigned Landlord hereby consents to the foregoing Agreement and confirms the facts stated in the foregoing Agreement.

LANDLORD:

By: _____

Name:

Title:

STATE OF NORTH CAROLINA)
) SS.
COUNTY OF MECKLENBURG)

On _____, 200_, personally appeared the above-named _____, the _____ of WACHOVIA BANK, NATIONAL ASSOCIATION, a national banking association, and acknowledged the foregoing to be the free act and deed of said association, before me.

Notary Public
My commission expires: _____

STATE OF _____)
) SS.
COUNTY OF _____)

On _____, 200_ personally appeared the above-named _____, the _____, of _____ and acknowledged the foregoing to be the free act and deed of said corporation, before me.

Notary Public
My commission expires: _____

STATE OF _____)
) SS.
COUNTY OF _____)

On _____, personally appeared the above-named _____, the _____, of _____ and acknowledged the foregoing to be the free act and deed of said corporation, before me.

Notary Public
My commission expires: _____

EXHIBIT H

MEMORANDUM OF RENT COMMENCEMENT DATE AND EXPIRATION DATE

The undersigned are the parties to that certain Lease dated _____, 20____, for those certain premises known as J-115 located at 540 Pine Avenue, Long Beach, California. Pursuant to the terms of the Lease, the undersigned hereby acknowledge and agree upon the following dates:

1. The Rent Commencement Date of the Lease is agreed to be: _____.
2. The Expiration Date of the Lease is agreed to be: _____.

The above is agreed to by the undersigned as of _____, 20____.

LANDLORD:

City Place Long Beach, LLC
a Delaware limited liability company

By: _____
Farshad Shooshani, Manager

City Place Long Beach TIC I, LLC
a Delaware limited liability company

By: _____
Farshad Shooshani, Manager

City Place Long Beach TIC 2, LLC
a Delaware limited liability company

By: _____
Farshad Shooshani, Manager

TENANT:

City of Long Beach, a municipal corporation

By: _____

(Print Name)

Its: _____

EXHIBIT I
FORM OF SUBLEASE

Robert E. Shannon
City Attorney of Long Beach
333 West Ocean Boulevard
Long Beach, California 90802-4664
Telephone (562) 570-2200

SUBLEASE

1
2
3 THIS SUBLEASE is made and entered, in duplicate, as of _____,
4 2007, for reference purposes only, pursuant to a minute order adopted by the City Council
5 of the City of Long Beach at its meeting on October 24, 2006, by and between ARTHUR
6 L. PETERSON POST NO. 27, INC., The American Legion, Department of California
7 ("Subtenant"), and the CITY OF LONG BEACH, a municipal corporation ("City").

8 1. Premises. City hereby subleases to Subtenant and Subtenant hereby
9 subleases from City a portion of the premises located at 540 Pine Avenue (Building J-115),
10 Long Beach, California, described in Exhibit "A" attached hereto and incorporated herein
11 by this reference, together with certain designated areas in common with other subtenants,
12 also depicted on Exhibit "A" (collectively, the "Premises").

13 2. Term. The term of this Sublease shall begin at 12:00 a.m. on the first full
14 day in which Subtenant has possession of the Premises and shall expire on the date which
15 is five years thereafter, unless sooner terminated as provided herein. The parties shall
16 each execute a Memorandum of Commencement and Expiration Dates in the form
17 attached hereto as Exhibit "C" in order to reflect the commencement date and expiration
18 date of this Sublease once the same have been determined. If City exercises any of its
19 options to extend the term of Lease No. _____, a copy of which is attached hereto as
20 Exhibit "B" and which is incorporated herein by this reference (the "Master Lease"), then
21 City and Subtenant shall extend the term of this Sublease to correspond to the term of the
22 Master Lease and this Sublease shall be amended accordingly.

23 3. Use. The Premises shall be used solely for general offices for Subtenant.
24 No other use is authorized or permitted. Notwithstanding the foregoing, City shall have the
25 right to use the Premises on an occasional basis for community meetings and/or as an
26 election polling site.

27 4. Rent. There shall be no rent. City is obligated by law and by prior
28 agreements to provide a facility to Subtenant at no cost to Subtenant.

1 5. No Improvements. Subtenant shall not construct any improvements to the
2 Premises.

3 6. Utilities. City or the Landlord under the Master Lease shall provide utilities
4 to the Premises except that Subtenant shall pay for the use of telephone service.

5 7. Maintenance. City or the landlord under the Master Lease shall provide
6 maintenance to the Premises provided that Subtenant shall use its best efforts to keep the
7 Premises clean, and free of trash, debris, litter and the like and shall use its best efforts to
8 prevent damage to the Premises.

9 8. Insurance. Concurrent with the execution of this Sublease, Subtenant
10 shall procure and maintain, at its cost, during the term of this Sublease from an insurer
11 admitted in California or having a minimum rating of or equivalent to A:VIII in Best's
12 Insurance Guide:

13 A. Comprehensive General Liability Insurance with a combined single limit
14 of at least One Million Dollars (\$1,000,000) for each occurrence or Two Million Dollars
15 (\$2,000,000) general aggregate. Master Landlord and City, and each of their officials,
16 employees, and agents shall be covered as additional insureds with respect to liability
17 arising from activities performed by or on behalf of Subtenant. Said insurance shall be
18 primary insurance with respect to said additional insureds and shall contain a cross liability
19 endorsement.

20 B. "All Risk" property insurance in an amount sufficient to cover the full
21 replacement value of Subtenant's personal property, improvements and equipment on the
22 Premises.

23 C. Upon the execution of this Sublease, Subtenant shall deliver to City
24 certificates of insurance with original endorsements evidencing the coverage required by
25 this Sublease. The certificates and endorsements shall be signed by a person authorized
26 by the insurer to bind coverage on its behalf. City reserves the right to require complete
27 certified copies of all policies at any time.

28

1 D. Said insurance shall contain an endorsement requiring thirty (30) days'
2 prior written notice from insurer to City before cancellation or change of coverage.

3 E. Said insurance may provide for such deductibles or self-insured retention
4 as may be acceptable to the City Manager or designee. In the event such insurance does
5 provide for deductibles or self-insured retention, Subtenant shall fully protect City, its
6 officials and employees in the same manner as its interests would have been protected
7 had a policy of commercial insurance been in effect. With respect to damage to property
8 City and Subtenant hereby waive all rights of subrogation, one against the other, but only
9 to the extent that collectible commercial insurance is available for said damage.

10 F. The procuring of insurance shall not be construed as a limitation on
11 Subtenant's liability or as full performance on Subtenant's part of the indemnification
12 provisions of the Sublease. Subtenant understands and agrees that, notwithstanding any
13 insurance, Subtenant's obligation to defend and indemnify City and Master Landlord, and
14 each of their officials and employees hereunder is for the full amount of any damage, loss,
15 cost or expense.

16 G. Any modification or waiver of these insurance requirements shall only be
17 made with the written approval of the City Manager or designee.

18 9. No Relocation. Subtenant agrees that nothing contained in this Lease
19 creates any right in Subtenant for any relocation assistance or payment pursuant to the
20 provisions of Title 1, Division 7, Chapter 16 of the California Government Code from City
21 on the termination of this Sublease.

22 10. Nondiscrimination. Subject to applicable laws, rules, and regulations,
23 Subtenant shall not discriminate against anyone on the basis of age, gender, sexual
24 orientation, AIDS, AIDS related conditions, marital status, race, religion, creed, ancestry,
25 national origin, disability, handicap, or Vietnam Era veteran status in the use of the
26 Premises.

27 11. Compliance with Master Lease and Laws. Subtenant shall comply with
28 the terms of the Master Lease. In addition, Subtenant shall notify City in writing of any

Robert E. Shannon
City Attorney of Long Beach
333 West Ocean Boulevard
Long Beach, California 90802-4664
Telephone (562) 570-2200

1 problems that Subtenant experiences with respect to the Premises before Subtenant
2 contacts the landlord under the Master Lease. Furthermore, if Subtenant receives any
3 communication, oral or written, from the landlord under the Master Lease, then Subtenant
4 shall immediately contact City.

5 Subtenant shall comply with all laws, ordinances, rules, and regulations
6 required by all federal, state and local governmental authorities having jurisdiction over the
7 Premises and use of the Premises.

8 12. Notice. Any notice or notification hereunder shall be in writing and
9 personally delivered or deposited in the U. S. Mail, first class, postage prepaid, to City at
10 333 West Ocean Boulevard, Long Beach, California 90802 Attn: City Manager and to
11 Subtenant at the Premises. Notice shall be deemed effective on the date of mailing or on
12 the date personal delivery is made, whichever first occurs.

13 13. No Hazardous Materials. Subtenant shall not keep or store any goods,
14 merchandise, supplies, personal property, materials, or items of any kind on the Premises
15 which are in any way explosive or hazardous. Subtenant shall notify City if Subtenant
16 discovers or has knowledge of the presence or suspected presence of any hazardous
17 material on the Premises.

18 14. Indemnity. Subtenant shall defend, indemnify and hold harmless Master
19 Landlord and City, and each of their officials and employees from all claims, demands,
20 damages, causes of action, losses, liability, costs, or expenses (including reasonable
21 attorney's fees) which Master Landlord and/or City, or each of their officials and employees
22 may incur for injury to or death of persons or damage to or loss of property occurring in,
23 on, or about the Premises arising from Subtenant's occupancy, use or misuse of the
24 Premises.

25 15. No Damages. City shall not be liable to Subtenant for any damages to
26 Subtenant or Subtenant's property from any cause. To the extent permitted by law,
27 Subtenant waives all claims against City for damage or injury to person or property arising
28 or alleged to have arisen from any cause whatsoever, except City's gross negligence or

1 willful misconduct.

2 16. No Assignment or Sublease. Subtenant shall not assign or transfer this
3 Sublease or any interest in it nor any part of it.

4 17. Right of Access. City shall have the right of access to the Premises at
5 all reasonable times to inspect the Premises and in emergencies.

6 18. Destruction of Premises. Subtenant shall immediately notify City of any
7 damage or destruction to the Premises and the date and nature of the damage or
8 destruction. Subtenant shall promptly make proof of loss and proceed to collect all valid
9 claims that Subtenant may have against insurers or others based on such damage or
10 destruction. All amounts recovered as a result of said claims shall be used first for the
11 restoration of the Premises.

12 19. Abandonment. If Subtenant abandons the Premises or is dispossessed
13 by operation of law or otherwise, title to any personal property belonging to Subtenant and
14 left on the Premises forty-five (45) days after such abandonment or dispossession shall be
15 deemed to have been transferred to City. City shall thereafter have the right to remove and
16 to dispose of said property without liability to Subtenant or to any person claiming under
17 Subtenant, and shall have no duty to account therefor. Subtenant hereby names City's
18 City Manager as Subtenant's attorney-in-fact to execute and deliver such documents or
19 instruments as may be reasonably required by dispose of such abandoned property and
20 transfer title thereto.

21 20. Miscellaneous. The failure or delay of City to insist on strict enforcement
22 of any term, covenant, or condition of this Sublease shall not be deemed a waiver of any
23 right or remedy that City may have and shall not be deemed a waiver of any subsequent
24 or other breach of any term, covenant, or condition herein. Any waiver by City shall be in
25 writing. In any action or proceeding relating to this Sublease, the prevailing party shall be
26 entitled to its costs, including reasonable attorney's fees.

27 21. Possession on Termination or Expiration. Subtenant shall peaceably
28 deliver possession of the Premises to City on the effective date of termination or expiration

Robert E. Shannon
City Attorney of Long Beach
333 West Ocean Boulevard
Long Beach, California 90802-4664
Telephone (562) 570-2200

1 of this Sublease. On giving notice of termination to Subtenant, City shall have the right to
2 re-enter and take possession of the Premises without further notice and without instituting
3 summary or regular legal proceedings. This Sublease shall be binding on and inure to the
4 benefit of the parties and their successors, heirs, and personal representatives and all of
5 the parties hereto shall be jointly and severally liable. This Sublease shall be governed by
6 and construed in accordance with the laws of the State of California, except those
7 provisions relating to conflicts of laws. If the Premises are taken by right of eminent
8 domain or otherwise for any public or quasi-public use, then City shall have the right to
9 terminate this Sublease by giving thirty (30) days' prior notice to Subtenant and any award
10 shall belong to and be paid to City.

11 \\
12 \\
13 \\
14 \\
15 \\
16 \\
17 \\
18 \\
19 \\
20 \\
21 \\
22 \\
23 \\
24 \\
25 \\
26 \\
27 \\
28 \\

Robert E. Shannon
City Attorney of Long Beach
333 West Ocean Boulevard
Long Beach, California 90802-4664
Telephone (562) 570-2200

1
2
3
4
5
6
7
8
9
10
11
12
13
14
15
16
17
18
19
20
21
22
23
24
25
26
27
28

IN WITNESS WHEREOF, the parties have caused this Sublease to be duly executed with all of the formalities required by law as of the date first stated above.

ARTHUR L. PETERSON POST NO. 27, INC.,
The American Legion, Department of California

Dated: _____, 2007 By: _____
Commander/President

Dated: _____, 2007 By: _____
Finance Officer

"Subtenant"

CITY OF LONG BEACH, a municipal corporation

Dated: _____, 2007 By _____
City Manager

"City"

This Sublease is approved as to form on _____, 2007.

ROBERT E. SHANNON, City Attorney

By _____
Deputy

RFA:abc
2/23/07 06-05767
L:\APPS\CtyLaw32\WPDOCS\D023\005\00100615.WPD

EXHIBIT "A"
DEPICTION OF PREMISES
[SEE ATTACHED SHEET]

Robert E. Shannon
City Attorney of Long Beach
333 West Ocean Boulevard
Long Beach, California 90802-4664
Telephone (562) 570-2200

- 1
- 2
- 3
- 4
- 5
- 6
- 7
- 8
- 9
- 10
- 11
- 12
- 13
- 14
- 15
- 16
- 17
- 18
- 19
- 20
- 21
- 22
- 23
- 24
- 25
- 26
- 27
- 28

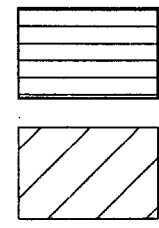
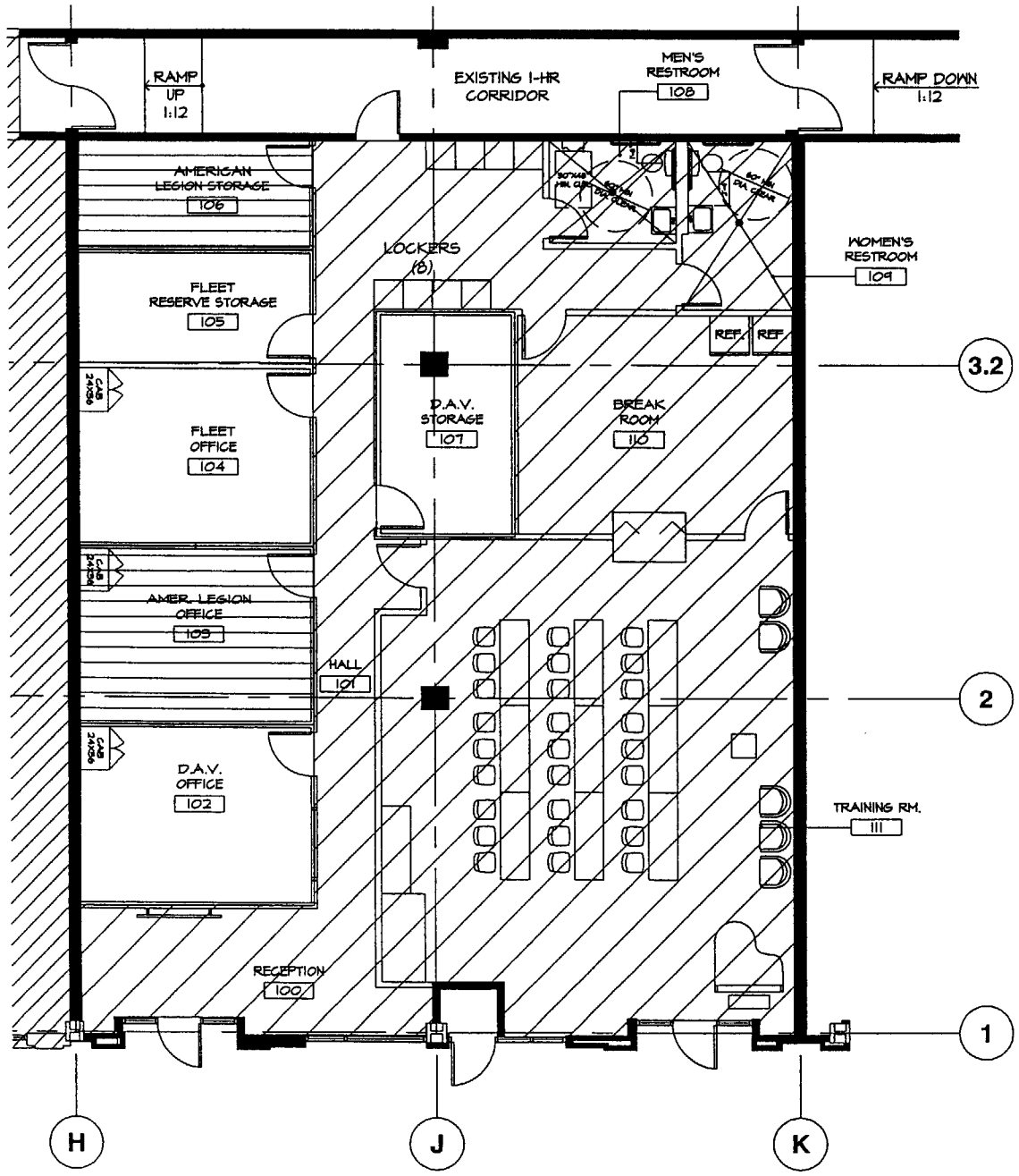

CITYPLACE
 LONG BEACH VETERAN'S ORGANIZATIONS
 540 PINE AVE.
 LONG BEACH, CA



Robert E. Shannon
City Attorney of Long Beach
333 West Ocean Boulevard
Long Beach, California 90802-4664
Telephone (562) 570-2200

- 1
- 2
- 3
- 4
- 5
- 6
- 7
- 8
- 9
- 10
- 11
- 12
- 13
- 14
- 15
- 16
- 17
- 18
- 19
- 20
- 21
- 22
- 23
- 24
- 25
- 26
- 27
- 28

EXHIBIT "B"
MASTER LEASE
[ATTACHED]

Robert E. Shannon
City Attorney of Long Beach
333 West Ocean Boulevard
Long Beach, California 90802-4664
Telephone (562) 570-2200

1
2
3
4
5
6
7
8
9
10
11
12
13
14
15
16
17
18
19
20
21
22
23
24
25
26
27
28

EXHIBIT "C"

MEMORANDUM OF COMMENCEMENT AND EXPIRATION DATES

The undersigned are parties to that certain Sublease dated _____, 2007 for certain Premises known as J-115 located at 540 Pine Avenue, Long Beach, California. Pursuant to the terms of the Sublease the undersigned hereby acknowledge and agree upon the following dates:

1. The commencement date of the Term of the Lease shall be: _____, 20__.
2. The expiration date of the Term of the Lease shall be: _____, 20__.

The above is agreed to by the undersigned as of _____, 20__.

ARTHUR L. PETERSON POST NO. 27, INC.,
The American Legion, Department of California

By: _____
Commander/President

By: _____
Finance Officer

"Subtenant"

CITY OF LONG BEACH, a municipal corporation

By _____
City Manager

"City"

This Memorandum is approved as to form on _____, 20__.

ROBERT E. SHANNON, City Attorney

By _____
Deputy

SUBLEASE

1
2
3 THIS SUBLEASE is made and entered, in duplicate, as of _____,
4 2007, for reference purposes only, pursuant to a minute order adopted by the City Council
5 of the City of Long Beach at its meeting on October 24, 2006, by and between FLEET
6 RESERVE ASSOCIATION, Branch 43 ("Subtenant"), and the CITY OF LONG BEACH, a
7 municipal corporation ("City").

8 1. Premises. City hereby subleases to Subtenant and Subtenant hereby
9 subleases from City a portion of the premises located at 540 Pine Avenue (Building J-115),
10 Long Beach, California, described in Exhibit "A" attached hereto and incorporated herein
11 by this reference, together with certain designated areas in common with other subtenants,
12 also depicted on Exhibit "A" (collectively, the "Premises").

13 2. Term. The term of this Sublease shall begin at 12:00 a.m. on the first full
14 day in which Subtenant has possession of the Premises and shall expire on the date which
15 is five years thereafter, unless sooner terminated as provided herein. The parties shall
16 each execute a Memorandum of Commencement and Expiration Dates in the form
17 attached hereto as Exhibit "C" in order to reflect the commencement date and expiration
18 date of this Sublease once the same have been determined. If City exercises any of its
19 options to extend the term of Lease No. _____, a copy of which is attached hereto as
20 Exhibit "B" and which is incorporated herein by this reference (the "Master Lease"), then
21 City and Subtenant shall extend the term of this Sublease to correspond to the term of the
22 Master Lease and this Sublease shall be amended accordingly.

23 3. Use. The Premises shall be used solely for general offices for Subtenant.
24 No other use is authorized or permitted. Notwithstanding the foregoing, City shall have the
25 right to use the Premises on an occasional basis for community meetings and/or as an
26 election polling site.

27 4. Rent. There shall be no rent. City is obligated by law and by prior
28 agreements to provide a facility to Subtenant at no cost to Subtenant.

Robert E. Shannon
City Attorney of Long Beach
333 West Ocean Boulevard
Long Beach, California 90802-4664
Telephone (562) 570-2200

Robert E. Shannon
City Attorney of Long Beach
333 West Ocean Boulevard
Long Beach, California 90802-4664
Telephone (562) 570-2200

1 5. No Improvements. Subtenant shall not construct any improvements to the
2 Premises.

3 6. Utilities. City or the Landlord under the Master Lease shall provide utilities
4 to the Premises except that Subtenant shall pay for the use of telephone service.

5 7. Maintenance. City or the landlord under the Master Lease shall provide
6 maintenance to the Premises provided that Subtenant shall use its best efforts to keep the
7 Premises clean, and free of trash, debris, litter and the like and shall use its best efforts to
8 prevent damage to the Premises.

9 8. Insurance. Concurrent with the execution of this Sublease, Subtenant
10 shall procure and maintain, at its cost, during the term of this Sublease from an insurer
11 admitted in California or having a minimum rating of or equivalent to A:VIII in Best's
12 Insurance Guide:

13 A. Comprehensive General Liability Insurance with a combined single limit
14 of at least One Million Dollars (\$1,000,000) for each occurrence or Two Million Dollars
15 (\$2,000,000) general aggregate. Master Landlord and City, and each of their officials,
16 employees, and agents shall be covered as additional insureds with respect to liability
17 arising from activities performed by or on behalf of Subtenant. Said insurance shall be
18 primary insurance with respect to said additional insureds and shall contain a cross liability
19 endorsement.

20 B. "All Risk" property insurance in an amount sufficient to cover the full
21 replacement value of Subtenant's personal property, improvements and equipment on the
22 Premises.

23 C. Upon the execution of this Sublease, Subtenant shall deliver to City
24 certificates of insurance with original endorsements evidencing the coverage required by
25 this Sublease. The certificates and endorsements shall be signed by a person authorized
26 by the insurer to bind coverage on its behalf. City reserves the right to require complete
27 certified copies of all policies at any time.

28

1 D. Said insurance shall contain an endorsement requiring thirty (30) days'
2 prior written notice from insurer to City before cancellation or change of coverage.

3 E. Said insurance may provide for such deductibles or self-insured retention
4 as may be acceptable to the City Manager or designee. In the event such insurance does
5 provide for deductibles or self-insured retention, Subtenant shall fully protect City, its
6 officials and employees in the same manner as its interests would have been protected
7 had a policy of commercial insurance been in effect. With respect to damage to property
8 City and Subtenant hereby waive all rights of subrogation, one against the other, but only
9 to the extent that collectible commercial insurance is available for said damage.

10 F. The procuring of insurance shall not be construed as a limitation on
11 Subtenant's liability or as full performance on Subtenant's part of the indemnification
12 provisions of the Sublease. Subtenant understands and agrees that, notwithstanding any
13 insurance, Subtenant's obligation to defend and indemnify City and Master Landlord, and
14 each of their officials and employees hereunder is for the full amount of any damage, loss,
15 cost or expense.

16 G. Any modification or waiver of these insurance requirements shall only be
17 made with the written approval of the City Manager or designee.

18 9. No Relocation. Subtenant agrees that nothing contained in this Lease
19 creates any right in Subtenant for any relocation assistance or payment pursuant to the
20 provisions of Title 1, Division 7, Chapter 16 of the California Government Code from City
21 on the termination of this Sublease.

22 10. Nondiscrimination. Subject to applicable laws, rules, and regulations,
23 Subtenant shall not discriminate against anyone on the basis of age, gender, sexual
24 orientation, AIDS, AIDS related conditions, marital status, race, religion, creed, ancestry,
25 national origin, disability, handicap, or Vietnam Era veteran status in the use of the
26 Premises.

27 11. Compliance with Master Lease and Laws. Subtenant shall comply with
28 the terms of the Master Lease. In addition, Subtenant shall notify City in writing of any

1 problems that Subtenant experiences with respect to the Premises before Subtenant
2 contacts the landlord under the Master Lease. Furthermore, if Subtenant receives any
3 communication, oral or written, from the landlord under the Master Lease, then Subtenant
4 shall immediately contact City.

5 Subtenant shall comply with all laws, ordinances, rules, and regulations
6 required by all federal, state and local governmental authorities having jurisdiction over the
7 Premises and use of the Premises.

8 12. Notice. Any notice or notification hereunder shall be in writing and
9 personally delivered or deposited in the U. S. Mail, first class, postage prepaid, to City at
10 333 West Ocean Boulevard, Long Beach, California 90802 Attn: City Manager and to
11 Subtenant at the Premises. Notice shall be deemed effective on the date of mailing or on
12 the date personal delivery is made, whichever first occurs.

13 13. No Hazardous Materials. Subtenant shall not keep or store any goods,
14 merchandise, supplies, personal property, materials, or items of any kind on the Premises
15 which are in any way explosive or hazardous. Subtenant shall notify City if Subtenant
16 discovers or has knowledge of the presence or suspected presence of any hazardous
17 material on the Premises.

18 14. Indemnity. Subtenant shall defend, indemnify and hold harmless Master
19 Landlord and City, and each of their officials and employees from all claims, demands,
20 damages, causes of action, losses, liability, costs, or expenses (including reasonable
21 attorney's fees) which Master Landlord and/or City, or each of their officials and employees
22 may incur for injury to or death of persons or damage to or loss of property occurring in,
23 on, or about the Premises arising from Subtenant's occupancy, use or misuse of the
24 Premises.

25 15. No Damages. City shall not be liable to Subtenant for any damages to
26 Subtenant or Subtenant's property from any cause. To the extent permitted by law,
27 Subtenant waives all claims against City for damage or injury to person or property arising
28 or alleged to have arisen from any cause whatsoever, except City's gross negligence or

1 willful misconduct.

2 16. No Assignment or Sublease. Subtenant shall not assign or transfer this
3 Sublease or any interest in it nor any part of it.

4 17. Right of Access. City shall have the right of access to the Premises at
5 all reasonable times to inspect the Premises and in emergencies.

6 18. Destruction of Premises. Subtenant shall immediately notify City of any
7 damage or destruction to the Premises and the date and nature of the damage or
8 destruction. Subtenant shall promptly make proof of loss and proceed to collect all valid
9 claims that Subtenant may have against insurers or others based on such damage or
10 destruction. All amounts recovered as a result of said claims shall be used first for the
11 restoration of the Premises.

12 19. Abandonment. If Subtenant abandons the Premises or is dispossessed
13 by operation of law or otherwise, title to any personal property belonging to Subtenant and
14 left on the Premises forty-five (45) days after such abandonment or dispossession shall be
15 deemed to have been transferred to City. City shall thereafter have the right to remove and
16 to dispose of said property without liability to Subtenant or to any person claiming under
17 Subtenant, and shall have no duty to account therefor. Subtenant hereby names City's
18 City Manager as Subtenant's attorney-in-fact to execute and deliver such documents or
19 instruments as may be reasonably required by dispose of such abandoned property and
20 transfer title thereto.

21 20. Miscellaneous. The failure or delay of City to insist on strict enforcement
22 of any term, covenant, or condition of this Sublease shall not be deemed a waiver of any
23 right or remedy that City may have and shall not be deemed a waiver of any subsequent
24 or other breach of any term, covenant, or condition herein. Any waiver by City shall be in
25 writing. In any action or proceeding relating to this Sublease, the prevailing party shall be
26 entitled to its costs, including reasonable attorney's fees.

27 21. Possession on Termination or Expiration. Subtenant shall peaceably
28 deliver possession of the Premises to City on the effective date of termination or expiration

Robert E. Shannon
City Attorney of Long Beach
333 West Ocean Boulevard
Long Beach, California 90802-4664
Telephone (562) 570-2200

1 of this Sublease. On giving notice of termination to Subtenant, City shall have the right to
2 re-enter and take possession of the Premises without further notice and without instituting
3 summary or regular legal proceedings. This Sublease shall be binding on and inure to the
4 benefit of the parties and their successors, heirs, and personal representatives and all of
5 the parties hereto shall be jointly and severally liable. This Sublease shall be governed by
6 and construed in accordance with the laws of the State of California, except those
7 provisions relating to conflicts of laws. If the Premises are taken by right of eminent
8 domain or otherwise for any public or quasi-public use, then City shall have the right to
9 terminate this Sublease by giving thirty (30) days' prior notice to Subtenant and any award
10 shall belong to and be paid to City.

11 \\
12 \\
13 \\
14 \\
15 \\
16 \\
17 \\
18 \\
19 \\
20 \\
21 \\
22 \\
23 \\
24 \\
25 \\
26 \\
27 \\
28 \\

Robert E. Shannon
City Attorney of Long Beach
333 West Ocean Boulevard
Long Beach, California 90802-4664
Telephone (562) 570-2200

1
2
3
4
5
6
7
8
9
10
11
12
13
14
15
16
17
18
19
20
21
22
23
24
25
26
27
28

IN WITNESS WHEREOF, the parties have caused this Sublease to be duly executed with all of the formalities required by law as of the date first stated above.

FLEET RESERVE ASSOCIATION, Branch 43

Dated: _____, 2007

By: _____
Commander/President

Dated: _____, 2007

By: _____
Finance Officer/Treasurer

"Subtenant"

CITY OF LONG BEACH, a municipal corporation

Dated: _____, 2007

By _____
City Manager

"City"

This Sublease is approved as to form on _____, 2007.

ROBERT E. SHANNON, City Attorney

By _____
Deputy

RFA:abc

2/23/07 06-05767

L:\APPS\CtyLaw32\WPDOCS\023\005\00101320.WPD

EXHIBIT "A"
DEPICTION OF PREMISES
[SEE ATTACHED SHEET]

- 1
- 2
- 3
- 4
- 5
- 6
- 7
- 8
- 9
- 10
- 11
- 12
- 13
- 14
- 15
- 16
- 17
- 18
- 19
- 20
- 21
- 22
- 23
- 24
- 25
- 26
- 27
- 28

Robert E. Shannon
City Attorney of Long Beach
333 West Ocean Boulevard
Long Beach, California 90802-4664
Telephone (562) 570-2200

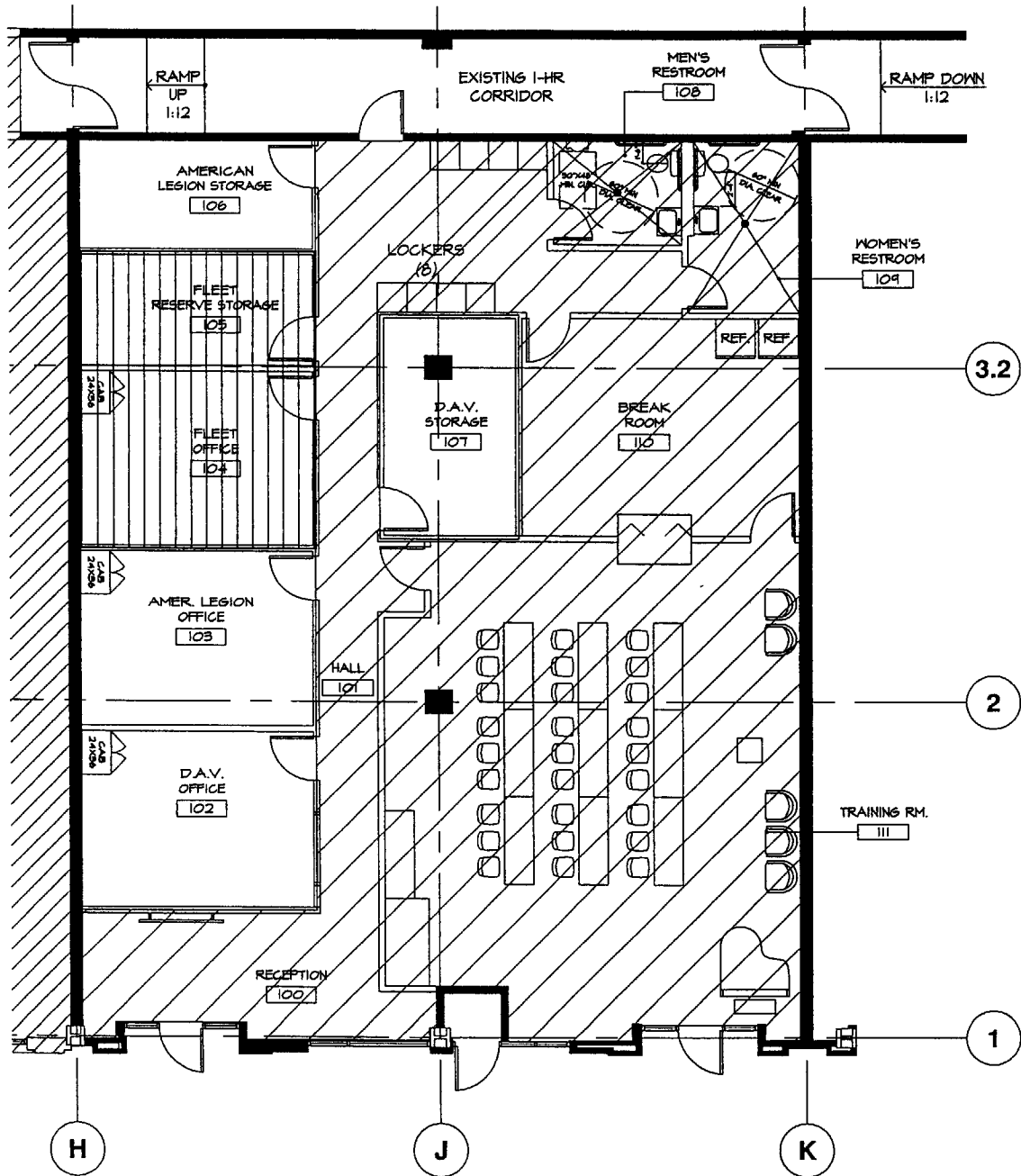

CITYPLACE
 LONG BEACH VETERAN'S ORGANIZATIONS
 540 PINE AVE.
 LONG BEACH, CA



Robert E. Shannon
City Attorney of Long Beach
333 West Ocean Boulevard
Long Beach, California 90802-4664
Telephone (562) 570-2200

1
2
3
4
5
6
7
8
9
10
11
12
13
14
15
16
17
18
19
20
21
22
23
24
25
26
27
28

EXHIBIT "B"
MASTER LEASE
[ATTACHED]

Robert E. Shannon
City Attorney of Long Beach
333 West Ocean Boulevard
Long Beach, California 90802-4664
Telephone (562) 570-2200

1
2
3
4
5
6
7
8
9
10
11
12
13
14
15
16
17
18
19
20
21
22
23
24
25
26
27
28

EXHIBIT "C"

MEMORANDUM OF COMMENCEMENT AND EXPIRATION DATES

The undersigned are parties to that certain Sublease dated _____, 2007 for certain Premises known as J-115 located at 540 Pine Avenue, Long Beach, California. Pursuant to the terms of the Sublease the undersigned hereby acknowledge and agree upon the following dates:

1. The commencement date of the Term of the Lease shall be: _____, 20__.
2. The expiration date of the Term of the Lease shall be: _____, 20__.

The above is agreed to by the undersigned as of _____, 20__.

FLEET RESERVE ASSOCIATION, Branch 43

By: _____
Commander/President

By: _____
Finance Officer/Treasurer

"Subtenant"

CITY OF LONG BEACH, a municipal corporation

By _____
City Manager

"City"

This Memorandum is approved as to form on _____, 20__.

ROBERT E. SHANNON, City Attorney

By _____
Deputy

S U B L E A S E

THIS SUBLEASE is made and entered, in duplicate, as of _____, 2007, for reference purposes only, pursuant to a minute order adopted by the City Council of the City of Long Beach at its meeting on October 24, 2006, by and between LONG BEACH CHAPTER NO. 17, DISABLED AMERICAN VETERANS, INC. ("Subtenant"), and the CITY OF LONG BEACH, a municipal corporation ("City").

1. Premises. City hereby subleases to Subtenant and Subtenant hereby subleases from City a portion of the premises located at 540 Pine Avenue (Building J-115), Long Beach, California, described in Exhibit "A" attached hereto and incorporated herein by this reference, together with certain designated areas in common with other subtenants, also depicted on Exhibit "A" (collectively, the "Premises").

2. Term. The term of this Sublease shall begin at 12:00 a.m. on the first full day in which Subtenant has possession of the Premises and shall expire on the date which is five years thereafter, unless sooner terminated as provided herein. The parties shall each execute a Memorandum of Commencement and Expiration Dates in the form attached hereto as Exhibit "C" in order to reflect the commencement date and expiration date of this Sublease once the same have been determined. If City exercises any of its options to extend the term of Lease No. _____, a copy of which is attached hereto as Exhibit "B" and which is incorporated herein by this reference (the "Master Lease"), then City and Subtenant shall extend the term of this Sublease to correspond to the term of the Master Lease and this Sublease shall be amended accordingly.

3. Use. The Premises shall be used solely for general offices for Subtenant. No other use is authorized or permitted. Notwithstanding the foregoing, City shall have the right to use the Premises on an occasional basis for community meetings and/or as an election polling site.

4. Rent. There shall be no rent. City is obligated by law and by prior agreements to provide a facility to Subtenant at no cost to Subtenant.

Robert E. Shannon
City Attorney of Long Beach
333 West Ocean Boulevard
Long Beach, California 90802-4664
Telephone (562) 570-2200

Robert E. Shannon
City Attorney of Long Beach
333 West Ocean Boulevard
Long Beach, California 90802-4664
Telephone (562) 570-2200

1 5. No Improvements. Subtenant shall not construct any improvements to the
2 Premises.

3 6. Utilities. City or the Landlord under the Master Lease shall provide utilities
4 to the Premises except that Subtenant shall pay for the use of telephone service.

5 7. Maintenance. City or the landlord under the Master Lease shall provide
6 maintenance to the Premises provided that Subtenant shall use its best efforts to keep the
7 Premises clean, and free of trash, debris, litter and the like and shall use its best efforts to
8 prevent damage to the Premises.

9 8. Insurance. Concurrent with the execution of this Sublease, Subtenant
10 shall procure and maintain, at its cost, during the term of this Sublease from an insurer
11 admitted in California or having a minimum rating of or equivalent to A:VIII in Best's
12 Insurance Guide:

13 A. Comprehensive General Liability Insurance with a combined single limit
14 of at least One Million Dollars (\$1,000,000) for each occurrence or Two Million Dollars
15 (\$2,000,000) general aggregate. Master Landlord and City, and each of their officials,
16 employees, and agents shall be covered as additional insureds with respect to liability
17 arising from activities performed by or on behalf of Subtenant. Said insurance shall be
18 primary insurance with respect to said additional insureds and shall contain a cross liability
19 endorsement.

20 B. "All Risk" property insurance in an amount sufficient to cover the full
21 replacement value of Subtenant's personal property, improvements and equipment on the
22 Premises.

23 C. Upon the execution of this Sublease, Subtenant shall deliver to City
24 certificates of insurance with original endorsements evidencing the coverage required by
25 this Sublease. The certificates and endorsements shall be signed by a person authorized
26 by the insurer to bind coverage on its behalf. City reserves the right to require complete
27 certified copies of all policies at any time.
28

1 D. Said insurance shall contain an endorsement requiring thirty (30) days'
2 prior written notice from insurer to City before cancellation or change of coverage.

3 E. Said insurance may provide for such deductibles or self-insured retention
4 as may be acceptable to the City Manager or designee. In the event such insurance does
5 provide for deductibles or self-insured retention, Subtenant shall fully protect City, its
6 officials and employees in the same manner as its interests would have been protected
7 had a policy of commercial insurance been in effect. With respect to damage to property
8 City and Subtenant hereby waive all rights of subrogation, one against the other, but only
9 to the extent that collectible commercial insurance is available for said damage.

10 F. The procuring of insurance shall not be construed as a limitation on
11 Subtenant's liability or as full performance on Subtenant's part of the indemnification
12 provisions of the Sublease. Subtenant understands and agrees that, notwithstanding any
13 insurance, Subtenant's obligation to defend and indemnify City and Master Landlord, and
14 each of their officials and employees hereunder is for the full amount of any damage, loss,
15 cost or expense.

16 G. Any modification or waiver of these insurance requirements shall only be
17 made with the written approval of the City Manager or designee.

18 9. No Relocation. Subtenant agrees that nothing contained in this Lease
19 creates any right in Subtenant for any relocation assistance or payment pursuant to the
20 provisions of Title 1, Division 7, Chapter 16 of the California Government Code from City
21 on the termination of this Sublease.

22 10. Nondiscrimination. Subject to applicable laws, rules, and regulations,
23 Subtenant shall not discriminate against anyone on the basis of age, gender, sexual
24 orientation, AIDS, AIDS related conditions, marital status, race, religion, creed, ancestry,
25 national origin, disability, handicap, or Vietnam Era veteran status in the use of the
26 Premises.

27 11. Compliance with Master Lease and Laws. Subtenant shall comply with
28 the terms of the Master Lease. In addition, Subtenant shall notify City in writing of any

Robert E. Shannon
City Attorney of Long Beach
333 West Ocean Boulevard
Long Beach, California 90802-4664
Telephone (562) 570-2200

1 problems that Subtenant experiences with respect to the Premises before Subtenant
2 contacts the landlord under the Master Lease. Furthermore, if Subtenant receives any
3 communication, oral or written, from the landlord under the Master Lease, then Subtenant
4 shall immediately contact City.

5 Subtenant shall comply with all laws, ordinances, rules, and regulations
6 required by all federal, state and local governmental authorities having jurisdiction over the
7 Premises and use of the Premises.

8 12. Notice. Any notice or notification hereunder shall be in writing and
9 personally delivered or deposited in the U. S. Mail, first class, postage prepaid, to City at
10 333 West Ocean Boulevard, Long Beach, California 90802 Attn: City Manager and to
11 Subtenant at the Premises. Notice shall be deemed effective on the date of mailing or on
12 the date personal delivery is made, whichever first occurs.

13 13. No Hazardous Materials. Subtenant shall not keep or store any goods,
14 merchandise, supplies, personal property, materials, or items of any kind on the Premises
15 which are in any way explosive or hazardous. Subtenant shall notify City if Subtenant
16 discovers or has knowledge of the presence or suspected presence of any hazardous
17 material on the Premises.

18 14. Indemnity. Subtenant shall defend, indemnify and hold harmless Master
19 Landlord and City, and each of their officials and employees from all claims, demands,
20 damages, causes of action, losses, liability, costs, or expenses (including reasonable
21 attorney's fees) which Master Landlord and/or City, or each of their officials and employees
22 may incur for injury to or death of persons or damage to or loss of property occurring in,
23 on, or about the Premises arising from Subtenant's occupancy, use or misuse of the
24 Premises.

25 15. No Damages. City shall not be liable to Subtenant for any damages to
26 Subtenant or Subtenant's property from any cause. To the extent permitted by law,
27 Subtenant waives all claims against City for damage or injury to person or property arising
28 or alleged to have arisen from any cause whatsoever, except City's gross negligence or

1 willful misconduct.

2 16. No Assignment or Sublease. Subtenant shall not assign or transfer this
3 Sublease or any interest in it nor any part of it.

4 17. Right of Access. City shall have the right of access to the Premises at
5 all reasonable times to inspect the Premises and in emergencies.

6 18. Destruction of Premises. Subtenant shall immediately notify City of any
7 damage or destruction to the Premises and the date and nature of the damage or
8 destruction. Subtenant shall promptly make proof of loss and proceed to collect all valid
9 claims that Subtenant may have against insurers or others based on such damage or
10 destruction. All amounts recovered as a result of said claims shall be used first for the
11 restoration of the Premises.

12 19. Abandonment. If Subtenant abandons the Premises or is dispossessed
13 by operation of law or otherwise, title to any personal property belonging to Subtenant and
14 left on the Premises forty-five (45) days after such abandonment or dispossession shall be
15 deemed to have been transferred to City. City shall thereafter have the right to remove and
16 to dispose of said property without liability to Subtenant or to any person claiming under
17 Subtenant, and shall have no duty to account therefor. Subtenant hereby names City's
18 City Manager as Subtenant's attorney-in-fact to execute and deliver such documents or
19 instruments as may be reasonably required by dispose of such abandoned property and
20 transfer title thereto.

21 20. Miscellaneous. The failure or delay of City to insist on strict enforcement
22 of any term, covenant, or condition of this Sublease shall not be deemed a waiver of any
23 right or remedy that City may have and shall not be deemed a waiver of any subsequent
24 or other breach of any term, covenant, or condition herein. Any waiver by City shall be in
25 writing. In any action or proceeding relating to this Sublease, the prevailing party shall be
26 entitled to its costs, including reasonable attorney's fees.

27 21. Possession on Termination or Expiration. Subtenant shall peaceably
28 deliver possession of the Premises to City on the effective date of termination or expiration

Robert E. Shannon
City Attorney of Long Beach
333 West Ocean Boulevard
Long Beach, California 90802-4664
Telephone (562) 570-2200

1 of this Sublease. On giving notice of termination to Subtenant, City shall have the right to
2 re-enter and take possession of the Premises without further notice and without instituting
3 summary or regular legal proceedings. This Sublease shall be binding on and inure to the
4 benefit of the parties and their successors, heirs, and personal representatives and all of
5 the parties hereto shall be jointly and severally liable. This Sublease shall be governed by
6 and construed in accordance with the laws of the State of California, except those
7 provisions relating to conflicts of laws. If the Premises are taken by right of eminent
8 domain or otherwise for any public or quasi-public use, then City shall have the right to
9 terminate this Sublease by giving thirty (30) days' prior notice to Subtenant and any award
10 shall belong to and be paid to City.

11 \\
12 \\
13 \\
14 \\
15 \\
16 \\
17 \\
18 \\
19 \\
20 \\
21 \\
22 \\
23 \\
24 \\
25 \\
26 \\
27 \\
28 \\

1
2
3
4
5
6
7
8
9
10
11
12
13
14
15
16
17
18
19
20
21
22
23
24
25
26
27
28

IN WITNESS WHEREOF, the parties have caused this Sublease to be duly executed with all of the formalities required by law as of the date first stated above.

LONG BEACH CHAPTER NO. 17, DISABLED AMERICAN VETERANS, INC.

Dated: _____, 2007 By: _____
Commander/President

Dated: _____, 2007 By: _____
Finance Officer/Treasurer

"Subtenant"

CITY OF LONG BEACH, a municipal corporation

Dated: _____, 2007 By _____
City Manager

"City"

This Sublease is approved as to form on _____, 2007.

ROBERT E. SHANNON, City Attorney

By _____
Deputy

Robert E. Shannon
City Attorney of Long Beach
333 West Ocean Boulevard
Long Beach, California 90802-4664
Telephone (562) 570-2200

RFA:abc
2/23/07 06-05767
L:\APPS\CtyLaw32\WPDOCS\D023\IP005\00101321.WPD

EXHIBIT "A"
DEPICTION OF PREMISES
[SEE ATTACHED SHEET]

Robert E. Shannon
City Attorney of Long Beach
333 West Ocean Boulevard
Long Beach, California 90802-4664
Telephone (562) 570-2200

- 1
- 2
- 3
- 4
- 5
- 6
- 7
- 8
- 9
- 10
- 11
- 12
- 13
- 14
- 15
- 16
- 17
- 18
- 19
- 20
- 21
- 22
- 23
- 24
- 25
- 26
- 27
- 28

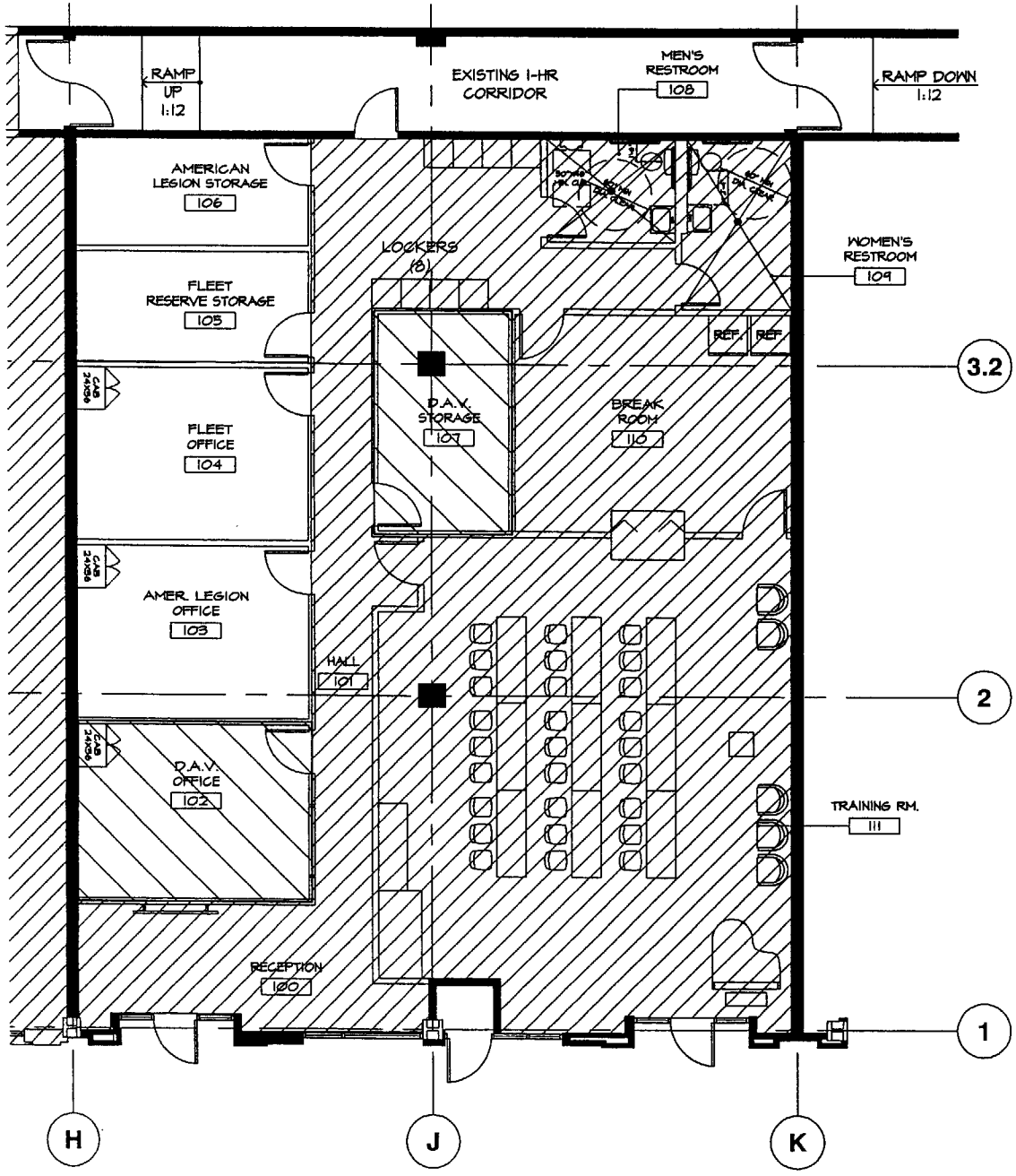

EXCLUSIVE USE OF D.A.V.

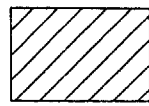

COMMON AREA

CITYPLACE
 LONG BEACH VETERAN'S ORGANIZATIONS
 540 PINE AVE.
 LONG BEACH, CA



Robert E. Shannon
City Attorney of Long Beach
333 West Ocean Boulevard
Long Beach, California 90802-4664
Telephone (562) 570-2200

1
2
3
4
5
6
7
8
9
10
11
12
13
14
15
16
17
18
19
20
21
22
23
24
25
26
27
28

EXHIBIT "B"
MASTER LEASE
[ATTACHED]

1
2
3
4
5
6
7
8
9
10
11
12
13
14
15
16
17
18
19
20
21
22
23
24
25
26
27
28

EXHIBIT "C"

MEMORANDUM OF COMMENCEMENT AND EXPIRATION DATES

The undersigned are parties to that certain Sublease dated _____, 2007 for certain Premises known as J-115 located at 540 Pine Avenue, Long Beach, California. Pursuant to the terms of the Sublease the undersigned hereby acknowledge and agree upon the following dates:

- 1. The commencement date of the Term of the Lease shall be: _____, 20__.
- 2. The expiration date of the Term of the Lease shall be: _____, 20__.

The above is agreed to by the undersigned as of _____, 20__.

LONG BEACH CHAPTER NO. 17, DISABLED AMERICAN VETERANS, INC.

By: _____
Commander/President

By: _____
Finance Officer/Treasurer

"Subtenant"
CITY OF LONG BEACH, a municipal corporation

By _____
City Manager

"City"

This Memorandum is approved as to form on _____, 20__.

ROBERT E. SHANNON, City Attorney

By _____
Deputy

Robert E. Shannon
City Attorney of Long Beach
333 West Ocean Boulevard
Long Beach, California 90802-4664
Telephone (562) 570-2200