

ORDINANCE NO.

AN ORDINANCE OF THE CITY COUNCIL OF THE
 CITY OF LONG BEACH AMENDING THE LONG BEACH
 MUNICIPAL CODE BY AMENDING AND RESTATING
 TITLE 18 IN ITS ENTIRETY; AND BY REPEALING
 CHAPTER 21.65, ALL RELATING TO THE ADOPTION AND
 AMENDMENTS TO THE 2013 EDITION OF THE
 CALIFORNIA BUILDING STANDARDS CODES AND THE
 1997 EDITION OF THE UNIFORM HOUSING CODE TO BE
 KNOWN AS THE LONG BEACH BUILDING STANDARDS
 CODE

The City Council of the City of Long Beach ordains as follows:

Section 1. Title 18 of the Long Beach Municipal Code is hereby
 amended in its entirety and restated as shown on Exhibit "A", which is attached hereto
 and incorporated herein by this reference as if set forth in full.

Section 2. Chapter 21.65 of the Long Beach Municipal Code is hereby
 repealed.

Section 3. The City Clerk shall certify to the passage of this ordinance by
 the City Council and cause it to be posted in three (3) conspicuous places in the City of
 Long Beach, and it shall take effect on the thirty-first (31st) day after it is approved by the
 Mayor, but in no event prior to January 1, 2014.

//

//

OFFICE OF THE CITY ATTORNEY
 CHARLES PARKIN, City Attorney
 333 West Ocean Boulevard, 11th Floor
 Long Beach, CA 90802-4664

1
2
3
4
5
6
7
8
9
10
11
12
13
14
15
16
17
18
19
20
21
22
23
24
25
26
27
28

OFFICE OF THE CITY ATTORNEY
CHARLES PARKIN, City Attorney
333 West Ocean Boulevard, 11th Floor
Long Beach, CA 90802-4664

1
2
3
4
5
6
7
8
9
10
11
12
13
14
15
16
17
18
19
20
21
22
23
24
25
26
27
28

I hereby certify that the foregoing ordinance was adopted by the City Council of the City of Long Beach at its meeting of _____, 20__ by the following vote:

Ayes: Councilmembers: _____

Noes: Councilmembers: _____

Absent: Councilmembers: _____

City Clerk

Approved: _____
(Date)

Mayor



AMENDED AND RESTATED TITLE 18

2014 CODE AMENDMENTS

TO THE LONG BEACH MUNICIPAL CODE

PREPARED BY

LBD DEVELOPMENT SERVICES



SUSTAINABLE
LONG BEACH

TABLE OF CONTENT

Chapter 18.01	GENERAL PROVISIONS
Chapter 18.02	DEFINITIONS
Chapter 18.03	ADMINISTRATION AND ENFORCEMENT
Chapter 18.04	PERMITS
Chapter 18.05	SUBMITTAL DOCUMENTS
Chapter 18.06	FEEES
Chapter 18.07	INSPECTIONS
Chapter 18.08	CERTIFICATE OF OCCUPANCY
Chapter 18.09	VIOLATIONS
Chapter 18.10	BOARD OF APPEALS
Chapter 18.17	TRANSPORTATION IMPROVEMENT FEE
Chapter 18.18	PARK AND RECREATION FACILITIES FEE
Chapter 18.20	UNSAFE BUILDINGS OR STRUCTURES
Chapter 18.21	MAINTENANCE OF LONG-TERM BOARDED AND VACATED BUILDINGS
Chapter 18.22	POLICE FACILITIES IMPACT FEE
Chapter 18.23	FIRE FACILITIES IMPACT FEE
Chapter 18.24	REGISTRY FOR FORECLOSURE
Chapter 18.25	TENANT RELOCATION AND CODE ENFORCEMENT
Chapter 18.40	BUILDING CODE
Chapter 18.41	RESIDENTIAL CODE
Chapter 18.42	ELECTRICAL CODE
Chapter 18.43	PLUMBING CODE
Chapter 18.44	MECHANICAL CODE
Chapter 18.45	HOUSING CODE
Chapter 18.46	ENERGY CODE
Chapter 18.47	GREEN BUILDING STANDARDS CODE
Chapter 18.48	FIRE CODE
Chapter 18.60	MOVING BUILDINGS
Chapter 18.61	NPDES & SUSMP REGULATIONS
Chapter 18.62	REPORT ON AVAILABLE OFF-STREET PARKING SPACES UPON RESALE
Chapter 18.63	ALTERNATIVE BUILDING STANDARDS FOR ADAPTIVE REUSE PROJECTS
Chapter 18.64	SANDBLASTING
Chapter 18.65	DEMOLITION OF HISTORIC LANDMARKS
Chapter 18.66	VISITABILITY OF DWELLING UNITS
Chapter 18.67	CONSTRUCTION AND DEMOLITION RECYCLING PROGRAM
Chapter 18.68	EARTHQUAKE HAZARD REGULATIONS
Chapter 18.69	VOLUNTARY EARTHQUAKE HAZARD REDUCTION IN EXISTING WOOD FRAME RESIDENTIAL BUILDINGS WITH WEAK CRIPPLE WALLS AND UNBOLTED SILL PLATES
Chapter 18.70	VOLUNTARY EARTHQUAKE HAZARD REDUCTION IN EXISTING WOOD FRAME RESIDENTIAL BUILDINGS WITH SOFT, WEAK OR OPEN FRONT WALLS
Chapter 18.71	VOLUNTARY EARTHQUAKE HAZARD REDUCTION IN EXISTING REINFORCED CONCRETE BUILDINGS AND CONCRETE FRAME BUILDINGS WITH MASONRY INFILLS
Chapter 18.72	VOLUNTARY EARTHQUAKE HAZARD REDUCTION IN EXISTING REINFORCED CONCRETE AND REINFORCED MASONRY WALL BUILDINGS WITH FLEXIBLE DIAPHRAGMS
Chapter 18.73	FLOOD RESISTANT DESIGN AND CONSTRUCTION
Chapter 18.74	LOW IMPACT DEVELOPMENT STANDARDS
Chapter 18.75	GRADING, EXCAVATIONS AND FILLS
Chapter 18.76	WATER SUBMETERS
Chapter 18.99	FINDINGS

CHAPTER 18.01 GENERAL PROVISIONS

18.01.010 – Title.

18.01.020 – Purpose.

18.01.030 – Scope.

18.01.040 – Work not in scope.

18.01.050 – Referenced codes.

18.01.060 – Applicability.

CHAPTER 18.01 GENERAL PROVISIONS

18.01.010 – Title.

These regulations shall be known as the "Long Beach Building Standards Code," a portion of the "Long Beach Municipal Code," hereinafter referred to as "this title." This title adopts by reference portions of the California Building Standards Code as required by Section 17958 of the California Health and Safety Code.

18.01.020 – Purpose.

The purpose of this title is to:

1. Establish the minimum requirements to safeguard the public health, safety and general welfare through structural strength, means of egress facilities, accessibility, stability, sanitation, adequate light and ventilation, energy conservation, and safety to life and property from fire and other hazards attributed to the built environment and to provide safety to fire fighters and emergency responders during emergency operations.
2. Provide minimum provisions considered necessary for safety, efficiency, adequacy and the practical safeguarding of persons and of buildings, structures and their contents from hazards arising from the use of electricity for light, heat, power, radio signaling and for other purposes, as well as some provisions for future expansion of electrical use.
3. Provide minimum requirements and standards for the protection of the public health, safety and welfare by regulating and controlling the design, construction, installation, quality of materials, location, operation and maintenance of plumbing fixture and fixture fittings, water heaters, water supply and distribution system, sanitary drainage, indirect wastes, vents, traps and interceptors, storm drainage, fuel piping, and gray water systems.
4. Provide minimum standards to safeguard life or limb, health, property and public welfare by regulating and controlling the design, construction, installation, quality of materials, location, operation and maintenance of heating, ventilating, cooling, refrigeration systems, incinerators and other miscellaneous heat producing appliances.
5. Improve public health, safety and general welfare by enhancing the design and construction of buildings through the use of building concepts having a reduced negative impact, or positive environmental impact and encouraging sustainable construction practices in planning and design, energy efficiency, water efficiency and conservation, material conservation and resource efficiency, and environmental quality.
6. Ensure public health, safety and welfare insofar as they are affected by the continued occupancy and maintenance of structures and premises.
7. Establish the minimum requirements consistent with nationally recognized good practice for providing a reasonable level of life safety and property protection from the hazards of fire, explosion or dangerous conditions in new and existing buildings, structures and premises and to provide safety to fire fighters and emergency responders during emergency operations.

18.01.030 – Scope.

The provisions of this title shall apply to:

1. The site preparation and the construction, alteration, relocation, enlargement, replacement, repair, equipment, use and occupancy, location, maintenance, removal and demolition of every building or structure or appertunances connected or attached to such buildings and

structures within the City, except work located primarily in a public way other than pedestrian protection structures required by Chapter 32 of the California Building Code adopted in Chapter 18.40, public utility, towers and poles, mechanical equipment not specifically regulated in this title, and hydraulic flood control structures.

2. All electrical systems or equipment installed, used, maintained, rented, leased, or offered for sale or distributed for use in the City, except those electrical systems and equipment exempted from the provisions of this title.
3. The erection, installation, alteration, repair, relocation, replacement, addition to, use, or maintenance of plumbing within the City, except those plumbing and plumbing installations exempted from the provisions of this title.
4. The addition to or erection, installation, alteration, repair, relocation, replacement, use, or maintenance of any heating, ventilating, cooling, refrigeration systems; incinerators; or other miscellaneous heat-producing appliances within the City, except those mechanical systems and equipment exempted from the provisions of this title.

18.01.040 – Work not in scope.

The provisions of this title shall not apply to any of the following:

1. Swings and other playground equipment accessory to detached one- and two-family dwellings.
2. *(Reserved)*
3. Towers or poles supporting public utility communication lines, antennas, or power transmission lines.
4. Gantry cranes, drill presses, and other similar manufactured machinery or equipment.
5. Water tanks supported on a foundation at grade if the capacity does not exceed five thousand (5,000) gallons (18,927 L) and the ratio of the height to diameter or width does not exceed two to one (2:1).
6. Temporary motion picture, television and theater stage sets and scenery that are not supported by any building.
7. Work in a public way, dams and drainage structures constructed by or under contract with the Department of Public Works, the Department of Water and the County Flood Control District, unless the structure forms a portion of the support for a building or a structure coming within the jurisdiction of the Building Official.
8. Portable amusement devices and structures, including merry-go-rounds, ferris wheels, rotating conveyances, slides, similar devices, and portable accessory structures whose use is necessary for the operation of such amusement devices and structures; any portable accessory structure included in the provisions of this chapter shall be limited to a cover or roof over each device, but shall not include any storage building or detached structure which is not an integral part of the device; and provided, however, that any electrical installations shall require subtrade permits where applicable and be regulated by this title; and provided further that any special event activity shall required Fire Department's approval.
9. Nothing in this title shall apply to any excavation, removal, fill or deposit of any earth or other materials from individual interment sites, underground crypts or burial vaults within a property which is dedicated or used for cemetery purposes, provided that such work does not affect

the lateral support or increase the stresses in or pressure upon any adjacent or contiguous property not owned by the cemetery authority.

10. Any portable metal hangar less than two thousand (2,000) square feet in size, located on the City-owned airport property, used for the parking of aircraft only, and bearing evidence of approval by the California Department of Motor Vehicles for movement on any highway. Such structure shall, as an integral part of its basic construction, be equipped with a hitch or coupling device for towing. It shall accommodate, without further major structural change, wheel and axle assemblies which will provide such structure with a safe means of portability. No water or sanitary facilities shall be permitted in such structure and it shall be equipped with permanent ventilation as required for group S-2 occupancy; and is not in violation of Title 21 Zoning Regulations.

18.01.050 – Referenced codes.

The codes listed in Subsections A through I and referenced elsewhere in this title shall be considered part of the requirements of this title to the prescribed extent of each such reference.

- A. Building. The provisions of the California Building Code adopted in Chapter 18.40 shall apply to the construction, alteration, movement, enlargement, replacement, repair, equipment, use and occupancy, location, maintenance, removal and demolition of every building or structure or any appurtenances connected or attached to such buildings or structures.
- B. Residential. The provisions of the California Residential Code adopted in Chapter 18.41 shall apply to the construction, alteration, movement, enlargement, replacement, repair, equipment, use and occupancy, location, removal and demolition of detached one- and two-family dwellings and townhouses not more than three (3) stories above grade plane in height with a separate means of egress and their accessory structures.

EXCEPTIONS:

1. Live/work units complying with the requirements of Section 419 of the California Building Code adopted in Chapter 18.40 shall be permitted to be built as one- and two-family dwellings or townhouses. Fire suppression required by Section 419.5 of the California Building Code when constructed under the California Residential Code adopted in Chapter 18.41 shall conform to Section R313.
 2. Owner-occupied lodging houses with five or fewer guestrooms shall be permitted to be constructed in accordance with the California Residential Code when equipped with a fire sprinkler system in accordance with Section R313.
- C. Electrical. The provisions of the California Electrical Code adopted in Chapter 18.42 shall apply to the installation of electrical systems, including alterations, repairs, replacement, equipment, appliances, fixtures, fittings and appurtenances thereto.
 - D. Plumbing. The provisions of the California Plumbing Code adopted in Chapter 18.43 shall apply to the installation, alteration, repair and replacement of plumbing systems, including equipment, appliances, fixtures, fittings and appurtenances, and where connected to a water or sewage system and all aspects of a medical gas system.

EXCEPTION: Chapter 18.43 shall not apply to any sewer constructed and maintained by a City department or agency within the public right of way.

- E. Mechanical. The provisions of the California Mechanical Code adopted in Chapter 18.44 shall apply to the installation, alterations, repairs and replacement of mechanical systems, including equipment, appliances, fixtures, fittings and/or appurtenances, including ventilating, heating, cooling, air-conditioning and refrigeration systems, incinerators and other energy-related systems.

- F. Housing. The provisions of the Uniform Housing Code adopted in Chapter 18.45 shall apply to existing structures and premises; equipment and facilities; light, ventilation, space heating, sanitation, life and fire safety hazards; responsibilities of owners, operators and occupants; and occupancy of existing buildings or portions thereof used, or designed or intended to be used, for human habitation.
- G. Energy. The provisions of the California Energy Code adopted in Chapter 18.46 shall apply to all matters governing the design and construction of buildings for energy efficiency.
- H. Green building standards. The provisions of the California Green Building Standards Code adopted in Chapter 18.47 shall apply to the planning, design, operation, construction, use and occupancy of every newly constructed building or structure, unless otherwise indicated in this title, throughout the City.
- I. Fire. The provisions of the California Fire Code adopted in Chapter 18.48 shall apply to matters affecting or relating to structures, processes and premises from the hazard of fire and explosion arising from the storage, handling or use of structures, materials or devices; from conditions hazardous to life, property or public welfare in the occupancy of structures or premises; and from the construction, extension, repair, alteration or removal of fire suppression and alarm systems or fire hazards in the structure or on the premises from occupancy or operation.

18.01.060 – Applicability.

- A. General. Where there is a conflict between a general requirement and a specific requirement, the specific requirement shall be applicable. Where, in any specific case, different chapters or sections of this title specify different materials, methods of construction or other requirements, the most restrictive shall govern. All the provisions of this title shall be limitations for safeguarding life, limb, health, property and public welfare. If two (2) or more pertinent limitations are not identical, those limitations shall prevail which provide the greater safety to life or limb, health, property or public welfare.
- B. Other laws. The provisions of this title shall not be deemed to nullify any provisions of local, State or Federal law.
- C. Referenced codes and standards. The codes and standards referenced in this title shall be considered part of the requirements of this title to the prescribed extent of each such reference. Where differences occur between provisions of this title and referenced codes and standards, the provisions of this title shall apply. Wherever in this title reference is made to the appendix of a referenced code or standard, the provisions in the appendix shall not apply unless specifically adopted by this title.
- D. Partial invalidity. In the event that any part or provision of this title is held to be illegal or void, this shall not have the effect of making void or illegal any of the other parts or provisions.
- E. Addition, alterations or repairs. Additions, alterations or repairs in all buildings and structures shall comply with the provisions for new buildings and structures except as otherwise specifically provided in Chapter 34 of the California Building Code adopted in Chapter 18.40.
- F. Change in use or occupancy. No change shall be made in the use or occupancy of any building except as specified in Section 3408 of the California Building Code adopted in Chapter 18.40 and as amended by Section 18.40.380.
- G. Existing buildings or structures.
 - 1. Legal occupancy. The legal occupancy of any structure existing on the date of adoption of this title shall be permitted to continue without change, except as is specifically covered in

this title, the Uniform Housing Code adopted in Chapter 18.45 or the California Fire Code adopted in Chapter 18.48, or as is deemed necessary by the Building Official for the general safety and welfare of the occupants and the public.

2. Responsibility for maintenance. All buildings and structures, both existing and new, and all parts thereof, shall be maintained in a safe and sanitary condition. All devices or safeguards that are required by this title shall be maintained in conformance with the code requirements under which it was installed. To determine compliance with this section, the Building Official may cause any building or structure to be reinspected.

Every owner remains liable for violations of duties imposed upon him or her by this title even though an obligation is also imposed on the occupants of his or her building, and even though the owner has, by agreement, imposed on the occupant the duty of furnishing required equipment or of complying with this title.

Every owner, or his or her agent, in addition to being responsible for maintaining his or her building in a sound structural condition, shall be responsible for keeping that part of the building or premises which he or she occupies or controls in a clean, sanitary and safe condition including the shared or public areas in a building containing two (2) or more dwellings.

H. Existing subtrade installation.

1. Existing electrical installation. Nothing contained in this title shall be construed to restrict the use, nor to require any person to reinstall, reconstruct, alter, change or remove any electrical wiring or equipment which complied with the laws and regulations of the City in effect before the effective date of this title unless the same is dangerous, unsafe or a hazard to life or property in the judgment of the Building Official. Additions or alterations to, and alterations and renewals of existing installations shall be made in compliance with the provisions of this title.

EXCEPTION: In locations where the existing electrical system was of some other type of approved wiring, an existing circuit may be increased to its maximum safe carrying capacity or with the addition of not to exceed five (5) lights, plugs or switch outlets. Not more than ten (10) such outlets may be added to an existing electrical system unless all new wiring is in conformity with the provisions of this title.

2. Existing plumbing installation. Nothing contained in this title, with the exception of the change of building occupancy or use, shall be construed to require any plumbing construction or work, regulated by this title to be altered, changed, reconstructed, removed or demolished if such plumbing work was installed which complied with the laws and regulations of the City in effect before the effective date of this title, unless the same is dangerous, unsafe, unsanitary or a menace to life, health or property, in the judgment of the Building Official.

Plumbing systems that are a part of any building or structure undergoing a change in use or occupancy shall comply with all requirements of this title that may be applicable to the new use or occupancy.

3. Existing mechanical installation. Additions, alterations or repairs may be made to any mechanical system without requiring the existing mechanical system to comply with all the requirements of this title, provided the addition, alteration or repair conforms to that required for a new mechanical system. Additions, alterations or repairs shall not cause an existing system to become unsafe, create unhealthy or overloaded conditions.

EXCEPTION: Minor additions, alterations and repairs to existing mechanical systems may be installed in accordance with the law in effect at the time the original installation was made if

such mechanical system may be used safety for such purposes, that there is an urgent necessity for such use, and if approved by the Building Official.

Heating, ventilating, cooling, or refrigeration systems, incinerators or other miscellaneous heat producing appliances lawfully installed prior to the effective date of this code may have their existing use, maintenance or repair continued if the use, maintenance or repair is in accordance with the original design and location and is not a hazard to life, health or property.

Mechanical systems that are a part of any building or structure undergoing a change in use or occupancy shall comply with all requirements of this title that may be applicable to the new use or occupancy.

All heating, ventilating, cooling, or refrigeration systems, incinerators or other miscellaneous heat-producing appliances, both existing and new, and all parts thereof, shall be maintained in a safe and sanitary condition. All devices or safeguards which are required by this title in heating, ventilating, cooling, or refrigeration systems, incinerators or other miscellaneous heat-producing appliances when installed, altered or repaired, shall be maintained in good working order. The owner, or his designated agent, shall be responsible for the maintenance of heating, ventilating, cooling, refrigeration systems, incinerators or other miscellaneous heat-producing appliances.

- I. Unsafe buildings or structures. The regulations for the abatement of unsafe buildings and structures are enumerated in Chapter 18.20.
- J. Long-term boarded or vacated buildings. The regulations for the maintenance of long-term boarded or vacated buildings are enumerated in Chapter 18.21.
- K. Temporary structures and uses. The regulations for temporary structures and uses are enumerated in Subsection 18.04.010.F.
- L. Moved buildings or structures. Buildings or structures moved into or within the jurisdiction shall comply with the provisions of this title for new buildings or structures. The regulations for moving buildings are enumerated in Chapter 18.60.

EXCEPTION: Apartment houses and dwellings shall be allowed the retention of existing materials and methods of construction so long as the apartment house or dwelling complies with the rules and regulations of the California Housing and Community Development Commission, complies with the standards for foundations applicable to new construction, and does not become or continue to be a substandard building.

CHAPTER 18.02 DEFINITIONS

- 18.02.010 – Interpretation.
- 18.02.020 – A definitions. (Reserved)
- 18.02.030 – B definitions.
- 18.02.040 – C definitions.
- 18.02.050 – D definitions.
- 18.02.060 – E definitions.
- 18.02.070 – F definitions.
- 18.02.080 – G definitions.
- 18.02.090 – H definitions.
- 18.02.100 – I definitions. (Reserved)
- 18.02.110 – J definitions. (Reserved)
- 18.02.120 – K definitions. (Reserved)
- 18.02.130 – L definitions. (Reserved)
- 18.02.140 – M definitions.
- 18.02.150 – N definitions.
- 18.02.160 – O definitions.
- 18.02.170 – P definitions.
- 18.02.180 – Q definitions. (Reserved)
- 18.02.190 – R definitions.
- 18.02.200 – S definitions.
- 18.02.210 – T definitions. (Reserved)
- 18.02.220 – U definitions.
- 18.02.230 – V definitions.
- 18.02.240 – W definitions. (Reserved)
- 18.02.250 – X definitions. (Reserved)
- 18.02.260 – Y definitions. (Reserved)
- 18.02.270 – Z definitions. (Reserved)

CHAPTER 18.02 DEFINITIONS

18.02.010 – General.

- A. Scope. Unless otherwise expressly stated, the following words and terms shall, for the purpose of this title, have meanings shown in this chapter.
- B. Interchangeability. Words used in the present tense include the future; words stated in the masculine gender include the feminine and neuter; the singular number includes the plural and the plural, the singular.
- C. Terms defined in other titles, chapters or codes. Where terms are not defined in this title and are defined in other titles, chapters or codes, such terms shall have the meanings ascribed to them as in those titles, chapters or codes.
- D. Terms not defined. Where terms are not defined through the methods authorized by this section, such terms shall have ordinarily accepted meanings such as the context implies. Webster's Third New International Dictionary of the English Language, Unabridged shall be considered as providing ordinarily accepted meanings.

18.02.020 – A definitions. (Reserved)

18.02.030 – B definitions.

"Building Code" means the code adopted in Chapter 18.40 of this title.

"Building Official" means the Superintendent of Building and Safety for the City of Long Beach Department of Development Services, Building and Safety Bureau, or a duly authorized representative designated by the Director.

18.02.040 – C definitions.

"California Building Code" or "CBC" means the code adopted in Chapter 18.40 of this title.

"California Electrical Code" or "CEC" means the code adopted in Chapter 18.42 of this title.

"California Energy Code" means the code adopted in Chapter 18.46 of this title.

"California Fire Code" or "CBC" means the code adopted in Chapter 18.48 of this title.

"California Green Building Standards Code" or "CGBSC" or "CalGreen Code" means the code adopted in Chapter 18.47 of this title.

"California Mechanical Code" or "CMC" means the code adopted in Chapter 18.44 of this title.

"California Plumbing Code" or "CBC" means the code adopted in Chapter 18.43 of this title.

"California Residential Code" or "CRC" means the code adopted in Chapter 18.41 of this title.

"Certificate of Occupancy" or "Occupancy Certificate" means the certificate issued by the Building Official pursuant to Chapter 18.08 when, after final inspection, it is found that a building or structure complies with all requirements of this title. When used with reference to a building or structure which was constructed and occupied prior to the effective date of any provisions requiring such a certificate, it shall mean the right to occupy such building or structure.

"City" means the City of Long Beach, California.

18.02.050 – D definitions.

"Dangerous building" means any building or structure which has any or all of the conditions or defects hereinafter described, provided that such conditions or defects exist to the extent that life, health, property, or safety of the public or its occupants are endangered or persons in the vicinity thereof:

1. Whenever any door, aisle, passageway, stairway or other means of exit is not of sufficient width or size, or is not so arranged as to provide safe and adequate means of exit in case of fire or panic;
2. Whenever the stress in any materials, member or portion thereof, due to all dead and live loads, is more than one and one-half (1-1/2) times the working stress or stresses allowed in this title for new buildings of similar structure, purpose or location;
3. Whenever any portion thereof has been damaged by fire, earthquake, wind, flood, or by any other cause, to such an extent that the structural strength or stability thereof is materially less than it was before such catastrophe and is less than the minimum requirements of this title for new buildings of similar structure, purpose or location;
4. Whenever any portion or member or appurtenance thereof is likely to fail, or to become detached or dislodged, or to collapse and thereby injure persons or damage property;
5. Whenever any portion of a building, or any member, appurtenance or ornamentation on the exterior thereof is not of sufficient strength or stability, or is not so anchored, attached or fastened in place so as to be capable of resisting a wind pressure of one-half (1/2) of that specified in this title for new buildings of similar structure, purpose or location without exceeding the working stresses permitted in this title for such buildings;
6. Whenever any portion thereof has wracked, warped, buckled or settled to such an extent that walls or other structural portions have materially less resistance to winds or earthquakes than is required in the case of similar new construction;
7. Whenever the building or structure, or any portion thereof, because of: (a) dilapidation, deterioration, or decay; (b) faulty construction; (c) the removal, movement or instability of any portion of the ground necessary for the purpose of supporting such building; (d) the deterioration, decay or inadequacy of its foundation; or (e) any other cause, is likely to partially or completely collapse;
8. Whenever, for any reason, the building or structure, or any portion thereof, is manifestly unsafe for the purpose for which it is being used;
9. Whenever the exterior walls or other vertical members list, lean or buckle to such an extent that a plumb line passing through the center of gravity does not fall inside the middle one-third (1/3) of the base;
10. Whenever the building or structure, exclusive of the foundation, shows thirty-three percent (33%) or more damage or deterioration of its supporting member or members, or fifty percent (50%) damage or deterioration of its nonsupporting members, enclosing or outside walls, or coverings;
11. Whenever the building or structure has been so damaged by fire, wind, earthquake or flood, or has become so dilapidated or deteriorated as to become: (a) an attractive nuisance to children; (b) a harbor for vagrants, criminals or immoral persons; or (c) as to enable persons to resort thereto for the purpose of committing unlawful or immoral acts;

12. Whenever any building or structure has been constructed, exists or is maintained in violation of any specific requirement or prohibition applicable to such building or structure provided by this title;
13. Whenever any building or structure which, whether or not erected in accordance with all applicable laws and ordinances, has in any nonsupporting part, member or portion less than fifty percent (50%), or in any supporting part, member or portion less than sixty-six percent (66%) of the: (a) strength; (b) fire-resisting qualities or characteristics; or (c) weather-resisting qualities or characteristics required by law in the case of a newly constructed building of like area, height and occupancy in the same location;
14. Whenever a building or structure, used or intended to be used for dwelling purposes, because of inadequate maintenance, dilapidations, decay, damage, faulty construction or arrangement, inadequate light, air or sanitation facilities, or otherwise, is determined by the City Health Officer to be unsanitary, unfit for human habitation or in such a condition that is likely to cause sickness or disease;
15. Whenever any building or structure, because of obsolescence, dilapidated condition, deterioration, damage, inadequate exits, lack of sufficient fire-resistive construction, faulty electric wiring, gas connections or heating apparatus, or other cause, is determined by the Chief of the Fire Department to be a fire hazard;
16. Whenever any building or structure is in such a condition as to constitute a public nuisance under common law or equity jurisprudence;
17. Whenever any portion of a building or structure remains on a site after the demolition or destruction of the building or structure or whenever any building or structure is abandoned for a period in excess of six (6) months so as to constitute such building or portion thereof an attractive nuisance or hazard to the public.

"Department" means the City of Long Beach Department of Development Services.

"Director" means the Director of Development Services for the City of Long Beach Department of Development Services or a duly authorized representative.

18.02.060 – E definitions.

"Electrical Code" means the code adopted in Chapter 18.42 of this title.

"Energy Code" means the code adopted in Chapter 18.46 of this title.

18.02.070 – F definitions.

"Fire Chief" means the Fire Chief of the City of Long Beach Fire Department or a duly authorized representative.

"Fire Code" means the code adopted in Chapter 18.48 of this title.

"Fire Code Official" means the Fire Marshal for the City of Long Beach Fire Department or a duly authorized representative designated by the Fire Chief.

"Foundation-only permit" is a building permit issued for that portion of a building which constitutes the footings for the building and which may, subject to the approval of the Building Official, include those portions of the building below the grade level.

18.02.080 – G definitions.

"Green Code" means the code adopted in Chapter 18.47 of this title.

18.02.090 – H definitions.

"Housing Code" means the code adopted in Chapter 18.45 of this title.

18.02.100 – I definitions. (Reserved)

18.02.110 – J definitions. (Reserved)

18.02.120 – K definitions. (Reserved)

18.02.130 – L definitions. (Reserved)

18.02.140 – M definitions.

"Mechanical Code" means the code adopted in Chapter 18.44 of this title.

18.02.150 – N definitions.

"Nuisance" means:

1. Any public nuisance known at common law or in equity jurisprudence or as declared by ordinance;
2. Any attractive nuisance which may prove detrimental to children whether in a building, on the premises of a building, or upon an unoccupied lot; this includes any abandoned structure, basement or excavation; any structurally unsound fence or structure; any lumber, trash, fence, debris or vegetation which may prove a hazard for inquisitive minors;
3. Whatever is dangerous to human life or is detrimental to health;
4. Overcrowding a room with occupants;
5. Insufficient ventilation or illumination;
6. Inadequate or unsanitary sewage or plumbing facilities;
7. Uncleanliness, when so determined by the Health Officer;
8. Whatever renders air, food or drink unwholesome or detrimental to the health of human beings when so determined by the Health Officer;
9. Dangerous or substandard buildings or conditions as defined in this title.

18.02.160 – O definitions.

"Occupancy Certificate" or "Certificate of Occupancy" means the certificate issued by the Building Official pursuant to Chapter 18.08 when, after final inspection, it is found that a building or structure complies with all requirements of this title. When used with reference to a building or structure which was constructed and occupied prior to the effective date of any provisions requiring such a certificate, it shall mean the right to occupy such building or structure.

"Occupancy" means the purpose for which a building, or part of a building, is used or intended to be used. The term "occupancy" as used in this title shall include the room housing that occupancy and

the space immediately above a roof or structure if used or intended to be used for other than a shelter.

18.02.170 – P definitions.

“Permittee” means the person, firm or corporation authorized to obtain a permit pursuant to Subsection 18.04.070.A of this title.

"Plumbing Code" means the code adopted in Chapter 18.43 of this title.

18.02.180 – Q definitions. (Reserved)

18.02.190 – R definitions.

"Residential Code" means the code adopted in Chapter 18.41 of this title.

18.02.200 – S definitions.

"Substandard building" means any building or other structure, or the premises on which the same is located, where any of the following conditions exist to an extent which, in the opinion of the Building Official, endangers the life, limb, health, property, safety or welfare of the occupants thereof, or of the public:

1. Inadequate sanitation. "Inadequate sanitation" shall include, but not be limited to, the following:
 - a. Lack of or improper water closet, lavatory, bathtub or shower in a dwelling unit;
 - b. Lack of or improper water closets, lavatories and bathtubs or showers per number of guests in a hotel;
 - c. Lack of or improper kitchen sink;
 - d. Lack of hot and cold running water to plumbing fixtures in a hotel;
 - e. Lack of hot and cold running water to plumbing fixtures in a dwelling unit;
 - f. Lack of adequate heating;
 - g. Lack of, or improper operation of, required ventilating equipment;
 - h. Lack of minimum amounts of natural light and ventilation required by this code;
 - i. Room and space dimensions less than required by this code;
 - j. Lack of required electrical lighting;
 - k. Dampness of habitable rooms;
 - l. Infestation of insects, vermin or rodents as determined by the Health Officer;
 - m. General dilapidation or improper maintenance;
 - n. Lack of connection to required sewage disposal system;
 - o. Lack of adequate garbage and rubbish storage and removal facilities as determined by the Health Officer.

2. Structural hazards. "Structural hazards" shall include, but not be limited to, the following:
 - a. Deteriorated or inadequate foundations;
 - b. Defective or deteriorated flooring or floor supports;
 - c. Flooring or floor supports of insufficient size to carry imposed loads with safety;
 - d. Members of walls, partitions or other vertical supports that split, lean, list or buckle due to defective material or deterioration;
 - e. Members of walls, partitions or other vertical supports that are of insufficient size to carry imposed loads with safety;
 - f. Members of ceilings, roofs, ceiling and roof supports, or other horizontal members which sag, split or buckle due to defective material or deterioration;
 - g. Members of ceilings, roofs, ceiling and roof supports, or other horizontal members that are of insufficient size to carry imposed loads with safety;
 - h. Fireplaces or chimneys which list, bulge or settle due to defective material or deterioration;
 - i. Fireplaces or chimneys which are of insufficient size or strength to carry imposed loads with safety.
3. Nuisance. Any "nuisance" as defined in this title.
4. Hazardous wiring. All wiring except that which conformed with all applicable laws in effect at the time of installation if it is currently in good and safe condition and working properly.
5. Hazardous plumbing. All plumbing except that which conformed with all applicable laws in effect at the time of installation and which has been maintained in good condition or which may not have conformed with all applicable laws in effect at the time of installation but is currently in good and safe condition and working properly and which is free of cross connections and siphonage between fixtures.
6. Hazardous mechanical equipment. All mechanical equipment, including vents, except that which conformed with all applicable laws in effect at the time of installation and which has been maintained in good and safe condition, or which may not have conformed with all applicable laws in effect at the time of installation but is currently in good and safe condition and working properly.
7. Faulty weather protection, which shall include, but not be limited to, the following:
 - a. Deteriorated, crumbling or loose plaster;
 - b. Deteriorated or ineffective water proofing of exterior walls, roof, foundations or floors, including broken windows or doors;
 - c. Defective or lack of weather protection for exterior wall coverings, including lack of paint, or weathering due to lack of paint or other approved protective covering;
 - d. Broken, rotted, split or buckled exterior wall coverings or roof coverings.

8. Fire hazard. Any building or portion thereof, device, apparatus, equipment, combustible waste or vegetation which, in the opinion of the Chief of the Fire Department or his or her deputy, is in such a condition as to cause a fire or explosion or provide a ready fuel to augment the spread and intensity of fire or explosion arising from any cause.
9. Faulty materials of construction. All materials of construction except those which are specifically allowed or approved by this title, and which have been adequately maintained in good and safe condition.
10. Hazardous or unsanitary premises. Those premises on which an accumulation of weeds, vegetation, junk, dead organic matter, debris, garbage, offal, rat harborages, stagnant water, combustible materials and similar materials or conditions constitute fire, health or safety hazards.
11. Inadequate maintenance. Any building or portion thereof which is determined to be dangerous as defined in Section 18.02.050.
12. Inadequate exits. All buildings or portions thereof not provided with adequate exit facilities as required by this title except those buildings or portions thereof whose exit facilities conformed with all applicable laws at the time of their construction and which have been adequately maintained and increased in relation to any increase in occupant load, alteration or addition, or any change in occupancy.

When an unsafe condition exists through lack of or improper location of exits, additional exits may be required to be installed.

13. Inadequate fire protection or firefighting equipment. All buildings or portions thereof which are not provided with the fire-resistive construction or fire extinguishing systems, or equipment required by this title, except those buildings or portions thereof which conformed with all applicable laws at the time of their construction and whose fire-resistive integrity and fire extinguishing systems or equipment have been adequately maintained and improved in relation to any increase in occupant load, alteration or addition, or any change in occupancy.
14. Improper occupancy. All buildings or portions thereof occupied for living, sleeping, cooking or dining purposes which are not designed or intended to be used for such occupancies.
15. Inadequate structural resistance to horizontal forces.

18.02.210 – T definitions. (Reserved)

18.02.220 – U definitions.

"Uniform Housing Code" or "UHC" means the code adopted in Chapter 18.45 of this title.

18.02.230 – V definitions.

"Value" or "valuation" means the total value of all construction work, including materials and labor, for which the permit is being issued, including all painting, roofing, electrical, plumbing, gas, mechanical, permanent or fixed heating equipment, elevator equipment, fire sprinkler equipment and any other permanent portions or permanent equipment except as provided in Section 18.04.020; or the estimated cost to replace the building or structure in kind, based on current replacement costs as determined herein.

18.02.240 – W definitions. (Reserved)

18.02.250 – X definitions. (Reserved)

18.02.260 – Y definitions. (Reserved)

18.02.270 – Z definitions. (Reserved)

CHAPTER 18.03 ADMINISTRATION AND ENFORCEMENT

18.03.010 – Department of Development Services.

18.03.020 – Duties and powers of the Building Official.

18.03.030 – Reports, records and fees.

18.03.040 – Liability.

18.03.050 – Modifications.

18.03.060 – Alternate materials, design and methods of construction and equipment.

CHAPTER 18.03 ADMINISTRATION AND ENFORCEMENT

18.03.010 – Department of Development Services.

- A. General. There is established in the City a Department known and designated as the Department of Development Services. In addition to the duties imposed upon said Department by the City Charter and other ordinances of the City, the Building and Safety Bureau of said Department is designated to enforce all of the provisions of State law applicable to the erection or construction of buildings or structures, except such provisions relating to maintenance, sanitation, occupancy and use which affect the health and welfare of occupants and which shall be designated by the City Manager as the responsibility of the City Health Officer or a duly authorized representative.
- B. Appointment. The City Manager shall, upon recommendation of the Director, appoint the Building Official as shall be required and shall be authorized from time to time by ordinance.
- C. Deputies. The City Manager shall, upon recommendation of the Director, appoint such officers, inspectors, plans examiners and other employees as shall be required and shall be authorized from time to time by ordinance.
- D. Certification. All construction inspectors, plans examiners and Building Official shall obtain certification when required by Section 18949.28 of the California Health and Safety Code from a recognized state, national, or international association, as determined by the City. The area of certification shall be closely related to the primary job function, as determined by the City.

18.03.020 – Duties and powers of the Building Official.

- A. General. The Building Official is hereby authorized and directed to enforce the provisions of this title, municipal code or other ordinances of the City or laws and statutes of the State and to make all plan examinations and inspections pursuant to the provisions of each such regulation. The Building Official shall also perform such other duties relating to the functions of the Department as may be required of him or her by general law, or by ordinance. For such purpose, the Building Official shall have the powers of a police officer. Any order of the City requiring alterations or repairs to any building shall be issued only by authorization of the Building Official. The Building Official shall have the authority to render interpretations of this title and to adopt policies and procedures in order to clarify the application of its provisions. Such interpretations, policies and procedures shall be in compliance with the intent and purpose of this title. Such policies and procedures shall not have the effect of waiving requirements specifically provided for in this title, municipal code or other ordinances of the City or laws and statutes of the State.
- B. Applications and permits. The Building Official shall receive applications, examine construction documents and issue permits for the erection, addition, alteration, demolition and moving of buildings and structures, inspect the premises for which such permits have been issued and enforce compliance with the provisions of this title, municipal code or other ordinances of the City or laws and statutes of the State.
- C. Notices and orders. The Building Official shall issue all necessary notices or orders to ensure compliance with the provisions of this title, municipal code or other ordinances of the City or laws and statutes of the State. Every such notice or order shall be in writing, addressed to the owner, agent or person responsible for the structure or premises in which such violations or unsafe condition exists and shall specify the date or time when such notice or order shall be complied with, which time shall allow a reasonable period in which such notice or order can be complied with by the person, firm or corporation receiving such notice or order in the judgment of the Building Official. No person, firm or corporation shall refuse, fail or neglect to comply with any such notice or order issued by the Building Official.

- D. Inspections. The Building Official shall make all of the required inspections, or the Building Official shall have the authority to accept reports of inspection by approved agencies or individuals. Reports of such inspection shall be in writing and be certified by a responsible officer of such approved agency or by the responsible individual. The Building Official is authorized to engage such expert opinion as deemed necessary to report upon unusual technical issues that arise.
- E. Identification. The Building Official shall carry proper identification when inspecting structures or premises in the performance of duties under this title.
- F. Right of entry. Where it is necessary to make an inspection to enforce the provisions of this title, municipal code or other ordinances of the City or laws and statutes of the State, or where the Building Official has reasonable cause to believe that there exists in a structure or upon a premises a condition which is contrary to or in violation of the provisions of this title, municipal code or other ordinances of the City or laws and statutes of the State which makes the structure or premises unsafe, dangerous or hazardous, the Building Official is authorized to enter the structure or premises at reasonable times to inspect or to perform the duties imposed by this title, provided that if such structure or premises be occupied that credentials be presented to the occupant and entry requested. If such structure or premises is unoccupied, the Building Official shall first make a reasonable effort to locate the owner or other person having charge or control of the structure or premises and request entry. If entry is refused, the Building Official shall have recourse to the remedies provided by law to secure entry.

When the Building Official has first obtained a proper inspection warrant or other remedy provided by law to secure entry, no owner or occupant or any other person having charge, care or control of any building or premises shall fail or neglect, after proper demand is made as provided in this section, to properly permit entry therein by the Building Official for the purpose of inspection and examination pursuant to this title.

- G. Authority to require exposure of work. Whenever any work on which called inspections are required as enumerated in Chapter 18.07 is covered or concealed by additional work without first having been inspected, the work shall be exposed for inspection upon written notice by the Building Official. The work of exposing and recovering shall not entail expense to the City.
- H. Authority to stop work. Whenever any construction work is being done contrary to the provisions of this title, municipal code or other ordinances of the City or laws and statutes of the State enforced by the Building Official, the Building Official shall have the authority to issue a written notice to the responsible party to stop work on that portion of the work on which the violation has occurred. The notice shall state the nature of the violation and no work shall be done on that portion until the violation has been rectified and approval obtained from the Building Official.
- I. Authority to stop use or occupancy. Whenever any portion of a building is loaded in excess for which it was constructed, or it houses a use or occupancy other than that for which it was constructed, or is determined to be an unsafe building or structure pursuant to Chapter 18.20, or there is an encroachment upon any required court, yard or easement, the Building Official shall have the authority to order by written notice that such violation be discontinued.

The written notice shall state the nature of the violations and shall fix a time for the abatement thereof. If the violations have not been abated by the expiration of the fixed time, the Certificate of Occupancy shall thereupon be canceled.

- J. Authority to disconnect electrical service. Whenever any electrical installation regulated by the provisions of this title, municipal code or other ordinances of the City or laws and statutes of the State is found to be defective, the Building Official shall have the authority to disconnect or to order the discontinuance of electrical service to such installation until the installation has been made safe, and any person, firm, corporation, political subdivision or governmental agency ordered to discontinue such electrical service shall do so within twenty four (24) hours or as

determined by the Building Official after the receipt of such notice and shall not reconnect such service or allow the same to be reconnected until notified to do so by the Building Official.

- K. Authority to disconnect utilities. Whenever any mechanical installation regulated by the provisions of this title, municipal code or other ordinances of the City or laws and statutes of the State is found to be defective that may pose an immediate hazard to life or property, the Building Official shall have the authority to disconnect or to order the discontinuance of fuel-gas utility service, or energy supplies, to the building, structure, premises or equipment in case of emergency. The Building Official shall, whenever possible, notify the serving utility, the owner and occupant of the building, structure or premises of the decision to disconnect prior to taking such action, and shall notify such serving utility, owner and occupant of the building, structure or premises in writing of such disconnection immediately thereafter and shall not reconnect such service or allow the same to be reconnected until such installation has been made safe and was notified to do so by the Building Official.
- L. Authority to condemn equipment. Whenever any equipment regulated by the provisions of this title, municipal code or other ordinances of the City or laws and statutes of the State has become hazardous to life, health, or property, the Building Official shall have the authority to condemn equipment when such equipment cannot be restored to a condition of safety or be dismantled or removed from its present location. The Building Official shall provide written notice to the owner or occupant of the building, structure, premises or equipment of such order and shall fix a time limit for compliance. No person shall use or maintain the defective equipment after receiving such notice.
- M. Authority to discontinue supply gas or water. Whenever any unsanitary conditions exist or that any construction or work regulated by the provisions of this title, municipal code or other ordinances of the City or laws and statutes of the State is dangerous, unsafe, unsanitary or a menace to life, health or property or is in violation of the provisions of this title, municipal code or other ordinances of the City or laws and statutes of the State, the Building Official, upon determining such information to be fact, shall have the authority to order any person, firm or corporation using or maintaining any such condition, or responsible for the use or maintenance thereof, to discontinue the use or the maintenance thereof or to repair, alter, change, remove or demolish the same as the Building Official may consider necessary for the proper protection of life, health or property; and in the case of any gas piping, gas appliance or water piping and any water using fixture or device, may order any person, firm or corporation supplying gas or water to such piping, appliance, fixture or device to discontinue supplying gas or water thereto until such piping, appliance, fixture or device is made safe to life, health and property.
- N. Authority to modify grading operation. The Building Official is authorized to require that grading operations and project designs be modified if delays occur which incur weather-generated problems not considered at the time the permit was issued.

18.03.030 – Reports, records and fees.

- A. Reports. The Building Official shall submit a report to the City Manager not less than once a year, covering the work of the Building and Safety Bureau during the preceding period. The Building Official shall incorporate in the report a summary of his or her recommendations as to desirable amendments to the law. The Building Official shall have charge of, and be responsible for, the drafting of recommendations regarding periodic revisions and amendments to the building, residential, electrical, plumbing, mechanical, housing, energy, green building standards and housing regulations of this title, municipal code or other ordinances of the City or laws and statutes of the State.
- B. Records. The Building Official shall keep official records of applications received, permits and certificates issued, fees collected, reports of inspections, and notices and orders issues. Such records shall be retained in the official records for the period required for retention of public records.

- C. Fees. The Building Official shall keep a permanent, accurate account of all fees and other monies collected and received under this title, the names of the persons upon whose account the same were paid, the date and amount thereof, together with the location of building or premises to which they relate.

18.03.040 – Liability.

The Building Official, members of the Board of Appeals or employees charged with the enforcement of the provisions of this title, municipal code or other ordinances of the City or laws and statutes of the State, while acting for the City in good faith and without malice in the discharge of the duties required by this title or other pertinent law or ordinance, shall not thereby be rendered liable personally and is hereby relieved from personal liability for any damage accruing to persons or property as a result of any act or by reason of an act or omission in the discharge of official duties. Any suit instituted against the Building Official, officer, plans examiner, inspector or other employee because of an act performed by the Building Official, officer, plans examiner, inspector or other employee in the lawful discharge of duties and under the provisions of this title shall be defended by legal representative of the City until the final termination of the proceedings. The Building Official or any subordinate shall not be liable for cost in any action, suit or proceeding that is instituted in pursuance of the provision of this title.

This title shall not be construed to relieve from or lessen the responsibility of any person, firm or corporation owning, operating or controlling any building or structure for any damages to persons or property caused by defects, nor shall the enforcing agency or the City be held as assuming any such liability by reason of the plans examinations or inspections authorized by this title or any permits or certificates issued under this title.

18.03.050 – Modifications.

- A. General. Whenever there are practical difficulties involved in carrying out the provisions of this title, the Building Official shall have the authority to grant modifications for individual cases, upon the application of the owner or owner's representative, provided the Building Official shall first find that special individual reason makes the strict letter of this title impractical and the modification is in compliance with the intent and purpose of this title and that such modification does not lessen health, accessibility, life and fire safety, or structural requirements. The details of action granting modifications shall be recorded and entered in the files of the Building and Safety Bureau. A written application shall be submitted together with a fee set forth in Section 18.06.160.
- B. Expiration. The rights and privileges granted by the Building Official shall be voided if the permit is not secured within twelve (12) months of the date the approval was granted or if the permit or plans examination expires under any of the conditions specified in Sections 18.04.060 or 18.05.060.

EXCEPTION: The Building Official may grant extensions of time if a permit applicant submits in writing substantial evidence that unusual condition or circumstances precluded the securing of the permit within the allocated time or caused the permit to expire.

18.03.060 – Alternate materials, design and methods of construction and equipment.

- A. General. The provisions of this title are not intended to prevent the installation of any materials or to prohibit any design or method of construction not specifically prescribed by this title, provided that any such alternative has been approved. An alternative material, design or method of construction shall be approved where the Building Official finds that the proposed design is satisfactory and complies with the intent of the provisions of this title, and that the material, method or work offered is, for the purpose intended, at least the equivalent of that prescribed in this title in quality, strength, effectiveness, fire resistance, durability and safety. The Building Official shall require that sufficient evidence or proof be submitted to substantiate any claims that

may be made regarding its use. A written application shall be submitted together with a fee set forth in Section 18.06.160.

- B. Research reports. Supporting data, where necessary to assist in the approval of materials or assemblies not specifically provided for in this title, shall consist of valid research reports from approved sources.
- C. Test. Whenever there is insufficient evidence of compliance with the provisions of this title, or evidence that a material or method does not conform to the requirements of this title, or in order to substantiate claims for alternative materials or methods, the Building Official shall have the authority to require tests as evidence of compliance to be made at no expense to the City. Test methods shall be as specified by this title or by other recognized test standards. In the absence of recognized and accepted test methods, the Building Official shall approve the test procedures. Tests shall be performed by an approved agency. Reports of such test shall be retained by the Building Official for the period required for retention of public records.
- D. Expiration. The rights and privileges granted by the Building Official shall be voided if the permit is not secured within twelve (12) months of the date the approval was granted or if the permit or plans examination expires under any of the conditions specified in Sections 18.04.060 or 18.05.060.

EXCEPTION: The Building Official may grant extensions of time if a permit applicant submits in writing substantial evidence that unusual conditions or circumstances precluded the securing of the permit within the allocated time or caused the permit to expire.

CHAPTER 18.04 PERMITS

18.04.010 – Permits required.

18.04.020 – Exceptions from permit.

18.04.030 – Permit applications.

18.04.040 – Permit issuance.

18.04.050 – Validity of permit.

18.04.060 – Expiration, suspension, revocation and transfer of permit.

18.04.070 – Requirement and responsibility of permittee.

CHAPTER 18.04 PERMITS

18.04.010 – Permits required.

- A. Building permits. No person, firm or corporation shall erect, construct, enlarge, alter, repair, remodel, move, remove, improve, convert or demolish any building or part of a building or structure, or change the character or occupancy or use of any building or structure, or part of a building or structure, in the City without first obtaining a permit covering such work from the Building Official.

A single combined permit may be issued for the construction of any one- or two-family dwelling and related accessory building and structure, or additions or alterations thereto, which includes all building, electrical, plumbing, heating, ventilating and air conditioning work.

- B. Grading permits. No person, firm or corporation shall commence or perform any grading, and no person shall import or export any earth materials to or from any grading site, without first having obtained a permit therefore from the Building Official. Any grading project involving more than one hundred (100) cubic yards of excavation and involving an excavation in excess of five (5) feet in vertical depth at its deepest point measured from the original ground surface shall be done by a State of California licensed contractor who is licensed to perform the work described herein. A separate permit shall be required for each grading site. One (1) permit may include the entire grading operation at that site, however.
- C. Electrical permits. No new electrical installation shall be made nor any alteration or addition performed to any existing wiring, nor shall any wiring for the placing or installation of any electric light, power or heating device, or any apparatus which generates, transmits, transforms or utilizes electricity operating at a voltage exceeding twenty-five (25) volts between conductors or capable of supplying more than fifty (50) watts, be made without first obtaining an electrical permit. A separate permit shall be obtained for the electrical wiring or installation in each separate building or structure.

EXCEPTION: A separate electrical permit shall not be required for any electrical work involving a one- or two-family dwelling and related accessory building or structure for which a combined permit has been obtained pursuant to Subsection 18.04.010.A.

- D. Plumbing permits. No person, firm or corporation shall construct, install or alter any plumbing, water piping, gas piping, water heater, water heater vents, water treating equipment, or any appliance or device regulated by this title without obtaining a plumbing permit approving the proposed quality and character of workmanship and materials. Where a building is demolished or removed from its site, a permit and inspection is required to verify that the building sewer, water and gas service is properly capped to the satisfaction of the Building Official. A separate permit shall be obtained for the plumbing installation in each separate building or structure.

EXCEPTION: A separate plumbing permit shall not be required for any plumbing work involving a one- or two-family dwelling and related accessory building or structure for which a combined permit has been obtained pursuant to Subsection 18.04.010.A.

- E. Mechanical permits. No person, firm or corporation shall install, alter, reconstruct or repair any heating, ventilating, cooling, or refrigeration equipment unless a permit therefore has been obtained from the Building Official except as otherwise provided in this title. A permit shall be obtained for all heating, ventilating, cooling, or refrigeration equipment, moved with, or installed in, any relocated building. A separate permit shall be obtained for the equipment installed in each separate building or structure.

EXCEPTION: A separate mechanical permit shall not be required for any mechanical work involving a one- or two-family dwelling and related accessory building or structure for which a combined permit has been obtained pursuant to Subsection 18.04.010.A.

F. Temporary permits. Before commencing the construction of any work for temporary structures or uses including but not limited to, reviewing stands, bleachers, tents, sheds, canopies or fences used for the protection of the public around and in conjunction with construction work, and other miscellaneous structures, a temporary permit authorizing such work shall be obtained therefore from the Building Official. Temporary permit may be restricted in the following conditions:

1. Application for permit. Except for canopies or fences used for the protection of the public around and in conjunction with construction work, application for permit shall be filed with and approved by the Building Official prior to the construction, erection or operation of any device, structure, or any work regulated by this title for temporary structure or use.
2. Time limit. Such construction shall be occupied or used only for the period set forth in Subsection 18.04.060.A.
3. Conformance. Temporary structures and uses shall conform to the structural strength, fire safety, means of egress, accessibility, light, ventilation and sanitary requirements of this title as necessary to ensure public health, safety and general welfare. Such temporary structures and temporary uses need not comply with the type of construction or fire-resistive time periods required by this title.
4. Temporary power. The Building Official is authorized to give permission to temporarily supply and use power in part of an electric installation before such installation has been fully completed and the final certificate of completion has been issued. The part covered by the temporary certificate shall comply with the requirements specified for temporary lighting, heat or power in the California Electrical Code adopted in Chapter 18.42.
5. Inspection. Notwithstanding Chapter 18.07 to the contrary, request for inspection must be received at least five (5) days prior to public use or occupancy.
6. Removal after expiration. All temporary construction or installations shall be demolished or removed within five (5) days after the expiration of the permit.
7. Termination of approval. The Building Official is authorized to terminate such permit for a temporary structure or use and to order the temporary structure or use to be discontinued.

G. Other permits.

1. Other permits must be obtained as required pursuant to any other provisions of this title, municipal code or other ordinances of the City or laws and statutes of the State.
2. No person, firm or corporation shall construct any signs and billboards without first obtaining a permit covering such work from the Building Official.

No person, firm or corporation shall hang, suspend or otherwise affix any sign, street banner, pole banner, flag, pennant or street decoration on any street light pole, traffic signal pole or over and above any street unless a permit to do so is first obtained from the City Manager. Permits issued pursuant to this section shall be in accordance with the provisions of Chapter 16.55 of Title 16, the City's policy on City sponsorship, corporate recognition and advertising, as adopted on July 23, 1996, as amended from time to time, and any guidelines that may from time to time be approved by the City Council.

EXCEPTION: The above provisions shall not apply to any sign or advertising matter lettered upon the surface of any awning, provided the awning is securely attached to a building and is not less than seven (7) feet above the sidewalk level immediately below.

3. No person, firm or corporation shall commence house moving in the City without first obtaining a permit covering such work from the Building Official.

18.04.020 – Exceptions from permit.

Exemption from the permit requirements of this title shall not be deemed to grant authorization for any work to be done in any manner in violation of the provisions of this title, municipal code or other ordinances of the City or laws and statutes of the State. Except for work undertaken to correct conditions determined to be substandard, nonconforming, dangerous or a nuisance under the provisions of Chapter 18.20, permits are not required for the following:

- A. Permits not required. Neither building, grading, subtrade or temporary permits of this title are required for the following:

1. Buildings or structures placed in public streets, alleys and sidewalks, except those regulated by Chapter 32 of the California Building Code adopted in Chapter 18.40.
2. Buildings or structures under the auspices of and owned or controlled by the federal government, the State of California, the County of Los Angeles, or by a public school district.
3. Work done by employees of the City on City-owned or leased buildings when approved by the Building Official and justifiable cause is demonstrated.
4. A temporary shed, office or storage building and other structure incidental to and for work authorized by a valid building, grading or subtrade permit. Such structures must be removed upon expiration of the permit or completion of work covered by the permit.

- B. Building permits not required. Building permits are not required for any of the following:

1. Where the work regulated by this title is valued at five hundred dollars (\$500.00) or less, unless it affects the fire life-safety, structural stability or required accessible route of a building or structure, or public safety, or is done to make a building conform to the requirements of this title for a change in occupancy or use; and is not in violation of Title 21 Zoning Regulations.
2. One story detached accessory structures used as tool and storage sheds, children's playhouses and similar uses, provided that the building or structure is accessory to a dwelling unit; it does not exceed one hundred twenty (120) square feet in area nor eight (8) feet in height from floor to roof; it contains no plumbing, electrical, or mechanical installations regulated by this title; and is not in violation of Title 21 Zoning Regulations.
3. Isolated buildings or structures not larger in area than sixteen (16) square feet in size, including roof projections, and not more than eight (8) feet in height, if separated by a distance of twenty (20) feet or more; and is not in violation of Title 21 Zoning Regulations.
4. Fences not over four (4) feet in height above grade; fences not over six (6) feet and six (6) inches in height above grade and not constructed of concrete, masonry, brick or other similar materials; and is not in violation of Title 21 Zoning Regulations.
5. Retaining walls or planter boxes that are not over four (4) feet in height measured from the bottom of the footing to the top of the wall, unless supporting a surcharge or sloping earth, or impounding flammable liquids; and is not in violation of Title 21 Zoning Regulations. This

- exemption shall not apply to retaining walls of any height built on slopes steeper than one (1) unit vertical in five (5) units horizontal (20% slope).
6. Unroofed platforms, walks, driveways and decks not more than thirty (30) inches above adjacent grade, not over any basement or story below, and not part of a required accessible route; and is not in violation of Title 21 Zoning Regulations.
 7. Application of hot or cold paint on a roof of a building or structure; and is not in violation of Title 21 Zoning Regulations.
 8. Application of roofing not in excess of five hundred (500) square feet on an existing building or structure within any twelve (12) month period; and is not in violation of Title 21 Zoning Regulations.
 9. Painting, papering, carpeting and similar finish work and are not required to comply with accessibility regulations.
 10. Installation of ceramic tile on floor or countertops and on walls less than forty-eight (48) inches in height.
 11. Replacement of broken or damaged ceramic tile in an existing installation.
 12. Plaster patching not in excess of ten (10) square yards of interior or exterior plaster; and is not in violation of Title 21 Zoning Regulations.
 13. Nonfixed and movable fixtures, cases, racks, counters and partitions not over five (5) feet nine (9) inches in height.
 14. Exhibits, booths, partitions and display counters for temporary use not exceeding thirty (30) days in conjunction with an exhibit or show and not exceeding twelve (12) feet in height above the floor.
 15. Window awnings in one- or two-family dwellings and related accessory building or structure supported by an exterior wall that do not project more than fifty-four (54) inches from the exterior wall and do not require additional support; and is not in violation of Title 21 Zoning Regulations.
 16. Swimming, bathing and wading pools not over two (2) feet in depth, provide a distance from the pool to the property lines and buildings or structures not less than the depth of the pool, and not having a surface area exceeding two hundred fifty (250) square feet; there is no electrical or plumbing installation; and is not in violation of Title 21 Zoning Regulations.
 17. Prefabricated swimming pools accessory to a one- or two-family dwelling that are less than twenty four (24) inches deep, do not exceed five thousand (5,000) gallons and are installed entirely above ground; it contains no plumbing, electrical, or mechanical installations regulated by this title; and is not in violation of Title 21 Zoning Regulations.
 18. Veneer less than four (4) feet in height.
 19. Waterproof pointing of joints in masonry or veneer, also cleaning with detergents which are not injurious to clothing or skin of persons and are not removed by liquid washing, provided work is done from safely enclosed scaffolding which will collect any dust, debris or dropped tools and materials in use.
 20. Prefabricated outdoor tents or canopy structures for temporary use not exceeding one hundred eighty (180) days, provided such tents or canopies are accessory to a one- or two-family dwelling on the site; and is not in violation of Title 9 Public Peace, Morals and Welfare,

Section 9.65.050 Prohibited Canopy Structure, Title 21 Zoning Regulations or the California Fire Code adopted in Chapter 18.48.

21. Shade cloth structures constructed for nursery or agricultural purposes, not including service system; and is not in violation of Title 21 Zoning Regulations.
22. Signs exempt under the provision of Section 21.44.070 of Title 21 Zoning Regulations.
23. Signs exempt under the provision of Section H101.2 of Appendix H of the California Building Code adopted in Chapter 18.40.

C. Grading permits not required. Grading permits are not required for any of the following:

1. An excavation which (a) is less than two (2) feet in depth, or (b) which does not create a cut slope greater than five (5) feet in height and steeper than one (1) unit vertical in two (2) units horizontal (50% slope). This exception shall not apply to cut which exceeds fifty (50) cubic yards or which changes the existing drainage pattern.
2. A fill less than one (1) foot in depth and placed on natural terrain with a slope flatter than one (1) unit vertical in ten (10) units horizontal (10% slope). This exception shall not apply when the fill exceeds fifty (50) cubic yards or when the fill changes the existing drainage pattern.
3. Excavations for caissons or piles under buildings or structures authorized by valid building permits.
4. Excavations for basements, footings, caissons, piles, swimming pools or underground structures that are authorized by valid building permits.
5. Excavations for wells or tunnels or utilities, which do not provide vertical or lateral support for buildings, or adversely impact the safety or stability of private or public properties.
6. Excavation in an isolated, self-contained area if the Building Official finds that by reason of such isolation and self-containment no danger to private or public property can now or thereafter result from grading operations.
7. Refuse disposal sites controlled by other regulations of local, State or federal departments or agencies.
8. Cemetery graves.
9. Exploratory excavation performed under the direction of a registered design professional.
10. Mining, quarrying, excavation, processing or stockpiling rock, sand, gravel, aggregate or clay controlled by other regulations of local, State or federal departments or agencies, provided such operations do not affect the lateral support of, or significantly increase stresses in, soil on adjoining properties.

D. Electrical permits not required. Electrical permits are not required for any of the following:

1. Electric wiring expressly declared to be exempt from the provisions of this title by any other section thereof.
2. Wiring for temporary theater sets on the theater stages or temporary motion picture or television sets on any property belonging to or under the control of the City, privately owned studios, theaters, or similar locations designed for that usage.

3. Installation of any portable motor or other portable appliance energized by means of a cord or cable having an attachment plug end, when that cord or cable is permitted by this title.
4. Festive temporary decorative lighting in dwelling occupancies only, for a period not to exceed ninety (90) days.
5. Repair or replacement of electrodes or transformers of the same size and capacity for signs or marquees, except for the retrofitting of lighting and exit fixtures that are part of a required emergency lighting system.
6. Removal of electric wiring.
7. Temporary wiring for experimental purposes in suitable experimental laboratories.
8. The following installation and electrical wiring:
 - a. Non-required signaling circuits supplied by an approved Class 2 limited power source, capable of supplying not more than thirty (30) volts and one hundred (100) volt-amperes.
 - b. Non-required communication circuits which have the power limited in accordance with Article 725 of the California Electrical Code adopted in Chapter 18.42.
 - c. Non-required amplifier output circuits which are permitted by Article 640 of the California Electrical Code adopted in Chapter 18.42 to employ Class 2 or Class 3 wiring.
 - d. Any non-required circuit which operates at fifteen (15) volts or less and does not generate, transmit, transform, utilize or control more than twenty-five (25) watts or volt-amperes of electric power.
 - e. Repair or replacement of fixed motors or fixed appliances, supplied by branch circuits not exceeding twenty (20) amperes and not exceeding two hundred forty (240) volts nominal, of the same type and rating in the same location.
 - f. Reinstallation of attachment wall plug receptacles or wall switches but not the outlet therefore.
 - g. Repair or replacement of current carrying parts or any switch, contactor or control device.
 - h. Taping of joints.

Provided the wiring for any of the above items is not located in any of the following locations or conditions:

- i. Area classified as “hazardous” under Article 500 of the California Electrical Code adopted in Chapter 18.42.
 - ii. Appurtenant to a required fire alarm system as classified under Article 760 of the California Electrical Code adopted in Chapter 18.42.
 - iii. Penetrating any fire-resistive wall or floor system.
 - iv. In a plenum, duct or other space used for environmental air including access floors.
9. Any similar minor repair or replacement determined by the Building Official not to involve any hazard to life or property.

10. Repair or replacement of incandescent lighting fixtures in one- or two-family dwelling and related accessory building and structure.
11. Any electric wiring, except wiring located in an area classified as “hazardous” under Article 500 of the California Electrical Code adopted in Chapter 18.42 after the branch circuit distribution panelboards used exclusively to supply or interconnect equipment installed, owned, operated or maintained by a communication public utility and used exclusively for communication purposes, in the exercise of its communication public utility functions within the communication public utility controlled areas.
12. The replacement of defective smoke detectors in a one- or two-family dwelling and related accessory building and structure when the work is performed by a contractor with a valid contractor license issued by the State and a valid business license issued by the City.
13. The installation by Southern California Edison Company of radio controlled relays on privately owned air conditioning equipment in the company's program of energy conservation through electrical load management, entitled "Air Conditioner Cycling Program", provided that:
 - a. The relays shall be tested and labeled by Underwriters' Laboratories, Inc.,
 - b. The Building Official shall approve of specifications for the installation of relays, and
 - c. The relays shall be installed and maintained by Southern California Edison Company or its contractors.
14. Repair or replacement of cords or cables or cord pendants allowed by other sections of this title.

The provisions of the foregoing exceptions shall not apply to any repairs or replacements of electrical devices, apparatus, or appliances which were originally installed without a permit when such permit is required for the original installation, or when energized by, or which is a part of any hazardous or illegal wiring system.

E. Plumbing permits. Plumbing permits are not required for any of the following:

1. The stopping of leaks or the repair of defects in any plumbing, provided no new materials are used.
2. The repair of a water heater other than its vents, provided the water heater is not disconnected.
3. The replacement of exposed traps serving fixtures, provided approved traps are used and are properly installed.
4. The replacement of defective or unapproved ball cocks in water tanks, provided antisiphon ball cocks are used and properly installed.
5. The replacement of defective or unapproved faucets serving sinks, lavatories and bathtubs, provided approved type faucets are used and are properly installed.
6. The replacement of an electric water heater, providing the rough plumbing is not altered.
7. Any gas piping not more than six (6) feet in length between an approved gas outlet and any gas fired appliance, provided that any such gas fired appliance is in the same room as the gas outlet.

8. Any sewer located entirely in the public right of way and under the authority of the Department of Public Works or Department of Water.
 9. A plumbing system, or part thereof, set up for exhibition purposes and has no connection with a water or drainage system; and is not in violation of any rules and regulations promulgated by the Department of Health and Human Services or the Department of Water.
- F. Mechanical permits. Mechanical permits are not required for any of the following:
1. Any portable heating appliance.
 2. Any portable ventilating equipment.
 3. Any portable cooling unit.
 4. Any steam, hot, or chilled water piping within any heating or cooling equipment regulated by this title.
 5. Replacement of any component part or assembly of an appliance which does not alter its original approval and complies with other applicable requirements of this title.
 6. Any portable evaporative cooler.
 7. Any refrigerating equipment that is a part of the equipment for which a permit has been issued pursuant to the requirements of this title.
 8. Any unit refrigerating system.

18.04.030 – Permit applications.

- A. Application for permit. To obtain a permit, the permit applicant shall first file an application therefore in writing on a form furnished by the Building Official for that purpose applicant and, in addition to the fee prescribed therefore and at the time of making application for such permit, pay a permit fee as set forth in Section 18.06.010. One complete application for each permit shall be filed. A separate permit shall be obtained for each building or structure, except that a permit for any one- or two-family dwelling may include related accessory building and structure located on the same premises if such building or structure does not contain living quarters provided with cooking facilities. Every such application shall:
1. Identify and describe the work to be covered by the permit for which application is made.
 2. Describe the land on which the proposed work is to be done by legal description, street address or similar description that will readily identify and definitely locate the proposed building or work.
 3. Indicate the use and occupancy for which the proposed work is intended.
 4. Be accompanied by construction documents and other information as required in Chapter 18.05.
 5. State the valuation of the proposed work.
 6. Be signed by the permit applicant, or the applicant's authorized agent, as required in Section 18.04.070.
 7. Give such other data and information as required by the Building Official.

8. State the estimated quantities of excavation and fill, when applicable.
- B. Action on application. The Building Official shall examine or cause to be examined applications for permits and amendments thereto within a reasonable time after filing. If the application or the construction documents do not conform to the provisions of this title, municipal code or other ordinances of the City or laws and statutes of the State, the Building Official shall reject such application in writing, stating the reasons therefore. If the Building Official is satisfied that the proposed work conforms to the provisions of this title, municipal code or other ordinances of the City or laws and statutes of the State applicable thereto, the Building Official shall issue a permit pursuant to Section 18.04.040.
- C. Time limitation of application. An application for a permit for any proposed work shall be deemed to have been abandoned after the date of filing, unless such application has been pursued in good faith and plans examination have not expired pursuant to Section 18.05.060 or a permit has been issued and have not expired pursuant to Section 18.04.060.

18.04.040 – Permit issuance.

- A. Issuance. When the Building Official determines that the proposed work conforms to the provisions of this title, municipal code or other ordinances of the City or laws and statutes of the State applicable thereto, including receiving approval from other departments or agencies in the City that regulate such proposed work, and that the fees and charges as set forth Chapter 18.06 and other liens, costs, and/or fees due to the City have been paid, the Building Official shall issue a permit therefore to the permittee meeting the requirement of Section 18.04.070.

EXCEPTIONS: The Building Official shall have the authority to withhold the issuance of permits under the following circumstances:

1. Harbor District. No permit shall be issued for the construction, extension, alteration, improvement, erection, remodeling or repair of any pier, slip, basin, wharf, dock or other harbor structure of any building or structure within the Harbor District, unless the Board of Harbor Commissioners has first granted permission authorizing such work to be done as provided in the charter of the City.
2. Marinas. No permit shall be issued for the construction, extension, alteration, improvement, erection, remodeling or repair of any pier, slip, basin, wharf, dock or other marina structure or any building or structure within the Alamitos Bay Marina, Downtown Shoreline Marina or Shoreline Harbor Marina unless the Manager of the Marine Bureau has first granted permission authorizing such work to be done.
3. Fault studies zone. No permit shall be issued for projects located within a special (fault) studies zone established under Chapter 7.5, Division 2, of the California Public Resources Code unless it can be demonstrated through accepted geologic seismic studies that the proposed structure will be located in a safe manner and not over or astraddle the trace of an active fault. Acceptable geologic seismic studies shall meet the criteria as set forth in rules and regulations established by the Building Official to ensure that such studies are based on sufficient geologic data to determine the location or nonexistence of the active fault trace on a site. Prior to approval of a project, a geologic report defining and delineating any hazard of surface fault rupture shall be required. If the City finds that no undue hazard of this kind exists, the geologic report on such hazard may be waived, with approval of the State Geologist.
4. Fills containing decomposable material. No permit shall be issued for buildings or structures regulated by this title within one thousand (1,000) feet of fills containing rubbish or other decomposable material unless the fill is isolated by approved natural or manmade protective systems or unless designed according to the recommendations contained in a report prepared by a registered design professional licensed in the State of California to practice as

such. Such report shall contain a description of the investigation, study and recommendation to minimize the possible intrusion, and to prevent the accumulation of explosive concentrations of decomposition gases within or under enclosed portions of such building or structure. At the time of the final inspection, the registered design professional shall furnish a signed statement attesting that the building or structure has been constructed in accordance with his or her recommendations as to decomposition gases required herein. Buildings or structures regulated by this title shall not be constructed on fills containing rubbish or other decomposable material unless provision is made to prevent damage to structure, floor, underground piping and utilities due to uneven settlement of the fill. One-story light frame accessory structures not exceeding four hundred (400) square feet in area nor twelve (12) feet in height may be constructed without special provisions for foundation stability.

- B. Phased approval. The Building Official is authorized to issue a permit for the construction of foundations or any other part of a building or structure before the construction documents for the whole building or structure have been approved, provided that adequate information and detailed statements have been filed complying with all pertinent requirements of this title. The holder of such permit for the foundation or other parts of a building or structure shall proceed at the holder's own risk with the building operation and without assurance that a permit for the entire structure will be granted.
- C. Placement of permit. The permit or copy shall be kept on the site of the work until the completion of the project.

18.04.050 – Validity of permit.

A. Limit of authorization.

- 1. The issuance or granting of a permit is not an approval or an authorization of the work specified therein. A permit is merely an application for inspection, the issuance of which entitles the permittee to inspection of the work that is described therein.
- 2. The issuance of a permit based on construction documents and other data shall not prevent the Building Official from requiring the correction of errors in the construction documents and other data.
- 3. Permits issued under the requirements of this title shall not relieve the owner of responsibility for securing required permits for work to be done which is regulated by any other title, code or other ordinances of the City or laws and statutes of the State.
- 4. All work are subject to the following conditions: If the work described by a valid permit is prohibited by a change in the municipal code, then such work may be completed only if the Building Official determines that both substantial liabilities have been incurred, and substantial work has been performed on site, in accordance with the terms of that permit. Work performed and liabilities incurred pursuant to a demolition or moving permit shall not be considered in determining whether an owner may complete a building or structure for which a permit has been issued.

- B. Validity of other laws. The issuance or granting of a permit shall not be construed to be a permit for, or an approval of, any violation of any of the provisions of this title, municipal code or other ordinances of the City or laws and statutes of the State. Permits presuming to give authority to violate or cancel the provisions of this title, municipal code or other ordinances of the City or laws and statutes of the State shall not be valid. The Building Official is authorized to prevent occupancy or use of a structure pursuant to Section 18.03.020 where in violation of the provisions of this title, municipal code or other ordinances of the City or laws and statutes of the State.

- C. Official grades. The permittee shall decide the correctness of proposed structure elevations and locations with respect to the official grades of public streets and to the policy of the Department of Public Works relative to the location and length of curb depressions for driveways.
- D. Easements. Before the issuance or granting of a permit, the Building Official shall require a declaration, under penalty of perjury, from the owner or agent having the property owner's consent stating that: "The proposed work will not destroy or unreasonably interfere with any access or utility easement belonging to others and located on my property, but in the event such work does destroy or unreasonably interfere with such easement, a substitute easement(s) satisfactory to the holder(s) of the easement will be provided."

18.04.060 – Expiration, suspension, revocation and transfer of permit.

- A. Expiration. Every permit issued shall be valid for a period of two (2) years from the date after its issuance; provided however that every permit issued shall expire on the ninetieth (90th) day after its issuance if the work on the site authorized by such permit has not commenced or has not been inspected as required by Chapter 18.07; or shall expire whenever the Building Official determines the work authorized by such permit has been suspended, discontinued or abandoned or has not been inspected as required by Chapter 18.07 for a continuous period of ninety (90) days after the time the work has commenced.

EXCEPTION: If the holder of any permit issued by the Building and Safety Bureau presents satisfactory evidence that unusual construction difficulties has prevented work from being started or continued without being suspended, discontinued or abandoned or the work has not been inspected within the ninetieth (90th) day time period or completed within the two-year period of validity, the Building Official may grant extensions of time reasonably necessary because of such difficulties. The extension shall be requested in writing on a form furnished by the Building Official for that purpose and justifiable cause is demonstrated pursuant to Section 18.03.050.

Notwithstanding the provisions of this subsection to the contrary, the time limit of a permit may be further restricted under the following conditions:

1. In the case of a building or structure that has been ordered repaired, rehabilitated, vacated or demolished in accordance with this title; ordered to correct a violation of this title in accordance with Chapters 18.03 and 18.20; or in the case of a responsible person that has been ordered to correct a violation or unsafe condition of a building or structure pursuant to Chapters 8.76, 9.37, or 9.65, such time limits as specified therein shall apply.
 2. The Building Official may, because of unusual circumstances or conditions such as, but not limited to, the repair, rehabilitation, vacation or demolition of an imminently hazardous, substandard, or dangerous building or structure, or a grading operation that may be subject to flooding during the rainy season between October 1st to April 15th, impose restrictions upon the time limits for expiration of any permit.
 3. Permit issued for temporary structures or uses shall be limited as to time of service, but shall not be permitted for more than one hundred eighty (180) days within the last twelve (12) months.
 4. Permit issued for moving buildings and structures pursuant to Chapter 18.60 shall be limited as specified in Section 18.60.190.
 5. Permit issued to complete the required work pursuant to Subsection 18.04.060.B shall be limited to thirty (30) days or such time limits as determined by the Building Official from the date of the permit issuance.
- B. Unfinished buildings or structures. Whenever the Building Official determines by inspection that work on any building or structure for which a permit has been issued and the work started thereon

has been suspended, discontinued or abandoned for a continuous period of ninety (90) days or more or the permit expired after the two-year period of validity, the owner of the property upon which such building or structure is located, or other person or agent in control of said property, upon receipt of notice in writing from the Building Official to do so, shall, within thirty (30) days or such time limits as specified therein from the date of such written notice, obtain a new permit to complete the required work, pay the fee of one-half (1/2) the amount required for a new permit for such work, provided no changes have been made or will be made in the original approved construction documents for such work, and diligently pursue the work to completion and provided, further, that such suspension, discontinuance or abandonment has not exceeded one hundred eighty (180) days; or shall remove or demolish the building or structure within ninety (90) days or such time limits as specified therein from the date of the written notice.

- C. Restore to original condition. Permits that have expired shall have the site, building or project restored to the condition that existed immediately prior to the commencement of work described by such permit.
- D. Suspension or revocation. The Building Official shall have the authority to, in writing, suspend or revoke a permit issued under provisions of this title whenever the permit is issued in error or on the basis of incorrect, inaccurate or incomplete information supplied, or in violation of any provisions of this title, municipal code or other ordinances of the City or laws and statutes of the State.
- E. Transfer of permit. Active permits required by this title may be transferred to a qualified person meeting the requirement of Section 18.04.070 for a fee as set forth in Section 18.06.170.

18.04.070 – Requirement and responsibility of permittee.

- A. Permittee. Permits as required by this chapter shall be issued only to the following individuals:
 - 1. A duly licensed contractor acting in compliance with the provisions of Sections 7000 through 7199 of the California Business and Professions Code and the Business License Regulations set forth in Title 5 of the municipal code, provided a written and signed statement from the duly licensed contractor stating that he or she is licensed, the number of the license and that it is in full force and effect as required by Section 7031.5 of the California Business and Professions Code.
 - 2. An owner of a one- or two-family dwelling and related accessory building or structure acting in compliance with the provisions of Section 7044 of the California Business and Professions Code; provided however that the improvements of the property are not intended or offered for sale, the owner occupies or intends to occupy one (1) of the units where such permit is to be obtained for the twelve (12) months prior to the completion of the work, and the owner has not performed work on more than two (2) buildings or structures during any three-year period.
 - 3. An owner-builder acting in compliance with the provisions of Section 7044 of the California Business and Professions Code; provided however that the owner-builder does the work himself or herself or through his or her own employees, with wages as their sole compensation, and the structure(s) is/are not intended for sale; or the owner-builder contracts with properly licensed subcontractors for the construction of a single-family residential structure and limits the number of structures intended or offered for sale to four (4) or fewer in a calendar year.
 - 4. A responsible person not acting in violation of Chapter 9 (commencing with Section 7000) of Division 3 of the California Business and Professions Code and the Business License Regulations set forth in Title 5 of the municipal code; provided a written and signed statement by the responsible person giving the basis for the alleged exemption from licensure under the Contractors' State License Law.

- B. Workers' compensation insurance verification. The Building Official is required by Section 3800(a) of the California Labor Code to verify workers' compensation insurance prior to issuing a permit. The permittee shall sign a declaration under penalty of perjury verifying Workers' Compensation Coverage or exemption from coverage as required by Section 19825 of the California Health and Safety Code.

- C. Responsibility. Permits shall be presumed to incorporate the provision that the permittee, the permittee's agent, employees, contractors or subcontractors shall carry out the proposed work in accordance with the approved construction documents and with all provisions of this title, municipal code or other ordinances of the City or laws and statutes of the State applicable thereto, whether specified or not. No approval shall relieve or exonerate any person from the responsibility of complying with the provisions and intent of this title, municipal code or other ordinances of the City or laws and statutes of the State applicable thereto.

CHAPTER 18.05 SUBMITTAL DOCUMENTS

18.05.010 – General.

18.05.020 – Number of construction documents.

18.05.030 – Construction documents.

18.05.040 – Examination of construction documents.

18.05.050 – Design professional in responsible charge.

18.05.060 – Expiration of plan examination.

18.05.070 – Retention and maintenance of construction documents.

CHAPTER 18.05 SUBMITTAL DOCUMENTS

18.05.010 – General.

Submittal documents consisting of construction documents, written record of computations, statement of special inspections, geotechnical report and other pertinent data shall be submitted with each permit application. The construction documents shall be prepared by a registered design professional licensed in the State of California to practice as such. Where special conditions exist, the Building Official is authorized to require additional construction documents to be prepared by a registered design professional.

EXCEPTION: The Building Official is authorized to waive the submission of construction documents and other data not required to be prepared by a registered design professional if the Building Official finds that the nature of the work applied for is such that the review of construction documents is not necessary to obtain compliance with the provisions of this title, municipal code or other ordinances of the City or laws and statutes of the State.

18.05.020 – Number of submittal documents.

Each application for a permit shall be accompanied by one (1) set of submittal documents for each type of plan examination or as determined by the Building Official.

18.05.030 – Construction documents.

A. Information on building or structure required.

1. Construction documents shall be dimensioned and drawn with ink or indelible pencil upon suitable material, or shall be made by a reproduction process approved by the Building Official. Electronic media documents are permitted to be submitted when approved by the Building Official. The first sheet of each set of construction documents shall give the street address of the work and the name and address of the owner of the building.
2. Construction documents shall be of sufficient clarity to indicate the location, nature and extent of the work proposed and show in detail that it will conform to the provisions of this title and relevant laws, ordinances, rules and regulations, as determined by the Building Official.
3. Construction documents for buildings of other than one- or two-family dwelling and related accessory building and structure shall indicate how required structural and fire-resistive integrity will be maintained where a penetration will be made for electrical, mechanical, plumbing and communication conduits, pipes and similar systems.
4. In lieu of detailed specifications, the Building Official may approve reference on the construction documents to a specific section, subsection or paragraph of this title, municipal code or other ordinances of the City or laws and statutes of the State.
5. Distances and dimensions on the construction documents, when required to show conformity with the provisions of this title, shall be done in figures.
6. The construction documents shall show in sufficient detail the location, construction, size and character of all portions of the means of egress, including the path of exit discharge to the public way, in compliance with the provisions of this title, municipal code or other ordinances of the City or laws and statutes of the State. In other than occupancies in Groups R-2, R-3, and I-1, the construction documents shall designate the number of occupants to be accommodated on every floor, and in all rooms and spaces.

7. Construction documents for all buildings shall describe the exterior wall envelope in sufficient detail to determine compliance with provisions of this title, municipal code or other ordinances of the City or laws and statutes of the State. The construction documents shall provided details of the exterior wall envelope as required, including flashing, intersections with dissimilar materials, corners, end details, control joints, intersections at roof, eaves or parapets, means of drainage, water-resistive membrane and details around openings.
8. The construction documents shall include manufacturer's installation instructions that provide supporting documentation that the proposed penetration and opening details described in the construction documents maintain the weather resistance of the exterior wall envelope. The supporting documentation shall fully describe the exterior wall system that was tested, where applicable, as well as the test procedure used.
9. When required by Section 1704.3 of the California Building Code adopted in Chapter 18.40, a statement of special inspection prepared by the registered design professional in responsible charge of the project shall be included with the construction documents.
10. The construction documents shall show all mitigation measures required under the National Pollutant Discharge Elimination System (NPDES) permit issued to the City of Long Beach and the requirements of the Standard Urban Storm Water Mitigation Plan (SUSMP) mandated by the California Regional Water Quality Control Board in accordance with Chapter 18.61 NPDES and SUSMP Regulations.
11. For buildings located in whole or in part in flood hazard areas as established in Section 1612 of the California Building Code adopted in Chapter 18.40, Table R301.2(1) of the California Residential Code adopted in Chapter 18.41, or Chapter 18.73 Flood Resistant Design and Construction, the construction documents shall include flood hazard documentations and design flood elevation information as required by provisions of this title, municipal code or other ordinances of the City or laws and statutes of the State.
12. The construction documents submitted with the application for permit shall be accompanied by a site plan showing to scale the size and location of new construction and existing structures on the site, distances from lot lines, the established street grades and the proposed finished grade and, as applicable, flood hazard areas, floodways, and design flood elevations; and it shall be drawn in accordance with an accurate boundary line survey. In the case of demolition, the site plan shall show construction to be demolished and the locations and size of existing structures and construction that are to remain on the site or plot.

EXCEPTION: The Building Official is authorized to waive or modify the requirement for a site plan when the application for permit is for alteration or repair or when otherwise warranted. Furthermore, the Building Official is authorized to grant the omission of a site plan when the proposed work is of such a nature that no information is needed to determine compliance with all laws relating to the location of buildings or occupancies.
13. When a structural design is required for the purpose of obtaining a permit, it shall be justified by a written record of computations filed with the Building Official and each sheet of the construction documents and written record of computations shall be signed by or bear the approved stamp of a registered design professional licensed by the State of California to practice as such. On structures which do not require a registered design professional's signatures according to Article 3, Chapter 7, Division 3, of the California Business and Professions Code but do require some structural design, the person responsible for such design shall sign the calculations and the sheets of the construction documents having engineering details thereon.
14. When reports are required by this subsection, recommendations included in the approved soils engineering report and engineering geology report shall be incorporated into the grading construction documents, including the dates of the soils engineering and engineering geology

reports together with the names, addresses and phone numbers of the firms or individuals who prepared the reports. A copy of the soils engineering report and engineering geology report shall be attached to the approved set of grading construction documents and kept at the job site. Reports shall be submitted to the Building Official for review and approval in, but not limited to, the following circumstances:

- a. When required by Section 1803 of the California Building Code adopted in Chapter 18.40.
- b. When required by Section 1806 of the California Building Code adopted in Chapter 18.40 to determine the classification, strength or compressibility of the soils for the purpose of assigning presumptive load-bearing values of soils and lateral sliding resistance.
- c. When projects are located on sites designated as Alquist-Priolo (Fault) Studies Zone.
- d. When previously unknown adverse soils or geologic conditions are revealed during construction.

The soils engineering report required by this section shall include data regarding the nature, distribution and strength of existing soils, conclusions and recommendations for grading procedures and design criteria for corrective measures, including buttress fills, when necessary, and opinion on adequacy for the intended use of sites to be developed by the proposed grading as affected by soils engineering factors, including the stability of slopes.

The engineering geology report required by this section shall include an adequate description of the geology of the site, conclusions and recommendations regarding the effect of geologic conditions on the proposed development, and opinion on the adequacy for the intended use of sites to be developed by the proposed grading, as affected by geologic factors.

EXCEPTIONS:

1. A soils and geological report is not required where the Building Official determines that the nature of the work applied for is such that a report is not necessary.
2. A liquefaction study is not required where the Building Official determines from established local data that the liquefaction potential is low.

All soils engineering and engineering geology reports shall comply with rules and standards established by the Building Official.

15. The increase in area permitted by Sections 506 and 507 of the California Building Code adopted in Chapter 18.40 shall not be allowed unless or until the owner of the required yard shall file with the Building Official an agreement binding such owner, heirs and assignees, to set aside the required yard as an unobstructed space having no improvements. Such agreement shall be recorded in the County Recorder's Office.

B. Information on grading required.

1. Application for a grading permit shall be accompanied by grading construction documents prepared and signed by a registered design professional licensed by the State of California to practice as such. The first sheet of each set of grading construction documents shall give location of the work, the name and address of the owner and the person by whom they were prepared. The grading construction documents shall include, but not be limited to, the following information:
 - a. General vicinity of the proposed site.

- b. Property limits and accurate contours of existing ground and details of terrain and area drainage.
 - c. Limiting dimensions, elevations or finish contours to be achieved by the grading, and proposed drainage channels and related construction.
 - d. Detailed plans of all surface and subsurface drainage devices, walls, cribbing, dams and other protective devices to be constructed with, or as a part of, the proposed work together with a map showing the drainage area and the estimated runoff of the area served by any drains.
 - e. Location of any buildings or structures on the property where the work is to be performed and the location of any buildings or structures on land of adjacent owners that are within fifteen (15) feet of the property or which may be affected by the proposed grading operations.
 - f. The location of the top and toe of all cuts and fills, the location of all "daylight" lines, the amount of cut and fill, the location of disposal site for excess material, if known, and the estimated dates for starting and completing grading work.
2. Grading construction documents shall be prepared by a registered land surveyor or registered civil engineer licensed in the State of California to practice as such when the property location and its limits are not clear.

EXCEPTION: Portions of the aforementioned grading construction documents requirements may be waived by the Building Official if he or she finds that the information on the application and/or submitted plans is sufficient to show that the work will conform to the provisions of this title, municipal code or other ordinances of the City or laws and statutes of the State.

3. The Building Official is authorized to require professional inspection and testing by the soils engineer. When the Building Official has cause to believe that geologic factors may be involved, the grading will be required to conform to engineering grading.

C. Information on electrical required.

1. When required by the Building Official for the enforcement of any provision of this title, construction documents for the installation of electrical wiring or equipment shall be filed with the Building Official and approved prior to the issuance of any permit.
2. Construction documents shall include sufficient information to demonstrate compliance for installations required to comply with the rules and regulations adopted by the California Energy Commission.
3. The construction documents shall show the following:
 - a. Construction documents shall be of sufficient clarity to show that the proposed electrical installation will conform to the provisions of this title, municipal code or other ordinances of the City or laws and statutes of the State.
 - b. First sheet of each set of construction documents shall show the address of the proposed work and the name and address of the owner or lessee of the premises.
 - c. Layout of the proposed electric systems for each floor or area, including dimensions of all working spaces, a full scope of the project and a legend of all symbols used.
 - d. The type, location and capacity of all service equipment.

- e. The size and the length of all service raceways to the manhole, vault or pole of the serving agency or to the service head.
- f. The size of all raceways and the length of all feeder raceways.
- g. The dimensions of all pull or junction boxes larger than four inches trade size.
- h. The number, size, and type of all conductors to be installed in wiring enclosures.
- i. The location of every proposed outlet and switch in all parts of the building or structure including all fixed showcases, wall cases, and similar wiring.
- j. The wattage or ampere ratings of each outlet for noninductive loads and the volt-ampere rating of each unit or transformer for electric discharge lighting.
- k. The location, voltage, and H.P. rating of every motor and the K.W. rating of every generator. The type and code letter of every A.C. motor shall be given unless otherwise satisfactory to the Building Official.
- l. The location and K.V.A., or equivalent rating of each transformer, capacitor, ballast, converter, frequency changer, and similar equipment and the location and ampere or wattage rating of other appliances of the noninductive type.
- m. Details of panelboard, switchboard, and distribution centers, showing type and arrangement of switches, overcurrent devices, and general control equipment.
- n. Panelboard and switchboard schedules showing wattage and amperage, the number of active branch circuits to be installed, and the number of spare branch circuits for future use. This shall include identifying the circuits to which the outlets are connected.
- o. The existing load, as calculated in accordance with Articles 210 and 220 of the California Electrical Code adopted in Chapter 18.42 or by other methods satisfactory to the Building Official, shall be indicated for existing installations having alterations or additions made to them.
- p. Other additional information as the Building Official may consider necessary for proper enforcement of this title.
- q. On all occupancies indicating location, rating and method being served for all new and existing power distribution equipment.
- r. Any or all engineering calculations as applicable for the installation.
- s. Interconnected wiring between all devices in each branch circuit from any panelboard or switch-board to the last device or load.
- t. Location of grounding and bonding, including but not limited to grounding electrode conductor sizes and length, grounding electrode(s) to be utilized, termination locations of all grounding electrode conductors, main and system bonding jumpers.
- u. Available fault current and documentation of preliminary design approval from Southern California Edison where the service is new or upgraded.
- v. Construction documents for buildings more than two (2) stories in height of other than one- or two-family dwelling and related accessory building or structure shall indicate how

required structural and fire resistive integrity will be maintained where a penetration will be made for electrical conduits, pipes and similar systems.

4. All electrical materials, devices, appliances and equipment installed or used in the City shall be in conformity with the provisions of this title, municipal code or other ordinances of the City or laws and statutes of the State. Conformity with the standards of the Underwriters' Laboratories, Inc., as approved by the American Standards Association, or other approved testing laboratory, shall be prima facie evidence of conformity with approved standards for safety to life and property. Previously used material shall not be reused in any work without the written approval obtained in advance from the Building Official.

D. Information on plumbing required.

1. When required by the Building Official for the enforcement of any provisions of this title, municipal code or other ordinances of the City or laws and statutes of the State, construction documents for the installation of any plumbing, water piping, gas piping, waste and vent piping, water heater, water heater vents, water treating equipment, or any appliance or device shall be filed with the Building Official and approved prior to the issuance of any permit.
2. The construction documents shall show the following:
 - a. Construction documents shall be of sufficient clarity to show that the proposed plumbing installation will conform to the provisions of this title, municipal code or other ordinances of the City or laws and statutes of the State.
 - b. First sheet of each set of construction documents shall show the address of the proposed work and the name and address of the owner or lessee of the premises.
 - c. Layout of the proposed plumbing systems for each floor or area, including dimensions of all working spaces, a full scope of the project and a legend of all symbols used.
 - d. Location, size and material of all plumbing pipes and fixtures.
 - e. System riser or isometric diagrams shall be provided for all drainage, waste and vent, fuel gas, potable water, storm drain, rain water, sump pump, combination waste and vent and standpipe systems.
 - f. Construction documents for buildings more than two (2) stories in height of other than one- or two-family dwelling and related accessory building or structure shall indicate how required structural and fire resistive integrity will be maintained where a penetration will be made for plumbing pipes and similar systems.

E. Information on mechanical required.

1. When required by the Building Official for the enforcement of any provisions of this title, municipal code or other ordinances of the City or laws and statutes of the State, construction documents for the installation of environmental heating or cooling systems, refrigeration systems, absorption systems, ventilation systems and hoods shall be filed with the Building Official and approved prior to the issuance of any permit.
2. Construction documents shall include sufficient information to demonstrate compliance for installations required to comply with the rules and regulations adopted by the California Energy Commission.
3. The construction documents shall show the following:

- a. Construction documents shall be of sufficient clarity to show that the proposed mechanical installation will conform to the provisions of this title, municipal code or other ordinances of the City or laws and statutes of the State.
- b. First sheet of each set of construction documents shall show the address of the proposed work and the name and address of the owner or lessee of the premises.
- c. Layout for each floor with dimensions of all working spaces and a legend of all symbols used.
- d. Location, size and materials of all air ducts, air inlets and air outlets.
- e. Location of all fans, warm-air furnaces, boilers, absorption units, refrigerant compressors and condensers and the weight of all pieces of such equipment weighing two hundred (200) pounds or more.
- f. Rated capacity or horsepower of all boilers, warm-air furnaces, heat exchangers, blower fans, refrigerant compressors and absorption units.
- g. Location, size and material of all combustion products, vents and chimneys.
- h. Location and area of all ventilation and combustion air openings and ducts.
- i. Location of all air dampers, fire dampers, smoke- control dampers and combustion-products-type smoke detectors.
- j. The information necessary to show compliance of the mechanical equipment with the California Energy Code adopted in Chapter 18.46.
- k. The occupancy of each area served by any heating, air-conditioning or ventilation system.
- l. The location of all required fire-resistive separations that are penetrated by ducts or openings of any heating, air-conditioning or ventilation system.
- m. The complete drawings of all commercial hoods and ventilation systems, including the cooking appliances served by the hoods, and verify:
 - i. The interconnection of the fire-extinguishing system and fuel shutoff devices.
 - ii. Compliance with Department of Health and Human Services requirements.
 - iii. Compliance with South Coast Air Quality Management District requirements.
- n. The weight of any equipment weighing more than that specified in Chapter 13 of ASCE 7.
- o. Construction documents for buildings more than two (2) stories in height of other than one- or two-family dwelling and related accessory building or structure shall indicate how required structural and fire resistive integrity will be maintained where a penetration will be made for mechanical conduits, pipes and similar systems.

18.05.040 – Examination of construction documents.

- A. General. When the permit applicant, in addition to the fee prescribed therefore and at the time of making application for such permit, pay a plan examination fee as set forth in Section 18.06.020, the Building Official shall examine or cause to be examined the accompanying submittal documents and shall ascertain by such examinations whether the construction indicated and

described is in accordance with the provisions of this title, municipal code or other ordinances of the City or laws and statutes of the State.

- B. Approval of construction documents. When the Building Official issues a permit pursuant to Section 18.04.040, the construction documents shall be approved, in writing or by stamp, as "APPROVED." One set of approved construction documents shall be retained and maintained pursuant to Section 18.05.070.
- C. Previous approvals. This title shall not require changes in the construction documents, construction or designated occupancy of a structure for which a lawful permit has been heretofore issued or otherwise lawfully authorized, and the construction of which has been pursued in good faith and has not been expired, suspended, discontinued or abandoned pursuant to Subsection 18.04.060.A or expired pursuant to Section 18.05.060.
- D. Amended construction documents. Work shall be installed in accordance with the approved construction documents, and any changes made during construction that are not in compliance with the approved construction documents shall be resubmitted for approval as an amended set of construction documents.
- E. Approved construction documents on job. One (1) set of approved construction documents issued to the permit applicant shall be kept at the site of the construction or work at all times during which the work authorized thereby is in progress and shall be available and open to inspection by the Building Official. Any deviation from the stamped or approved construction documents shall be in accordance with Subsection 18.05.040.D.
- F. Re-examining construction documents.
 - 1. Re-examining construction documents prior to approval. When construction documents have been examined and are subsequently so revised by the permit applicant for reasons other than plan examination correction as to necessitate re-examination, the Building Official shall require the permit applicant to pay a re-examination fee as set forth in Section 18.06.030 which would be required for the cost of that portion of the construction or work which has been revised. No additional permit fee will be required unless the revision increases the total cost of the entire project. In that event, the Building Official shall require the permit applicant to pay an additional permit fee based on the additional cost.

EXCEPTION: No additional plan examination fee shall be charged for verification of the corrections required by the Building Official.

- 2. Re-examining construction documents after approval. When construction documents are resubmitted for examination of changes made to previously approved construction documents, the permit applicant shall pay a re-examination fee as set forth in Section 18.06.030.

18.05.050 – Design professional in responsible charge.

- A. General. When it is required that documents be prepared by a registered design professional licensed in the State of California, the Building Official shall be authorized to require the owner to engage and designate on the permit application a registered design professional who shall act as the registered design professional in responsible charge. If the circumstances require, the owner may designate a substitute registered design professional in responsible charge who shall perform the duties required of the original registered design professional in responsible charge. The Building Official shall be notified in writing by the owner if the registered design professional in responsible charge is changed or is unable to continue to perform the duties.

The registered design professional in responsible charge shall be responsible for reviewing and coordinating submittal documents prepared by others, including phased and deferred submittal items, for compatibility with the design of the building.

B. Deferred submittals.

1. For the purposes of this section, deferred submittals are defined as those portions of the design which are not submitted at the time of the application and which are to be submitted to the Building Official within a specified period.
2. Deferral of any submittal items shall have prior approval of the Building Official. The registered design professional in responsible charge shall list the deferred submittals on the construction documents for review by the Building Official.
3. Documents for deferred submittal items shall be submitted to the registered design professional in responsible charge who shall review them and forward them to the Building Official with a notation indicating that the deferred submittal documents have been reviewed and been found to be in general conformance with the design of the building. The deferred submittal items shall not be installed until the Building Official has approved the deferred submittal documents.

C. Structural observation. Where structural observation is required by Section 1710 of the California Building Code adopted in Chapter 18.40, the statement of special inspections shall name the individual or firms who are to perform structural observation and describe the stages of construction at which structural observation is to occur.

18.05.060 – Expiration of plan examination.

If after a period of one (1) year from date of application for permit, any permit applicant has failed to pay for and obtain a permit pursuant to Subsection 18.04.040.A, such application and examination fee shall become invalid and no permit shall be issued unless a new application is submitted and a new examination fee paid pursuant to Section 18.06.020. Construction documents submitted at the time of application may be destroyed if after a period of one (1) year from date of application no permit has been paid for or issued.

EXCEPTION: The Building Official is authorized to grant one (1) or more extensions of time for additional periods not exceeding one hundred eighty (180) days each. The extension shall be requested in writing on a form furnished by the Building Official for that purpose and justifiable cause is demonstrated pursuant to Section 18.03.050.

18.05.070 – Retention and maintenance of construction documents.

- A. Retention of construction documents. The duplicate approved construction documents of every building or structure shall be stamped and retained by the Building Official for a period of not less than one (1) year from the date of completion of the work covered therein, after which time the Building Official may, at his or her discretion, either dispose of the copies or retain them as a part of the permanent files of the Building Official as required by Section 19850 of the California Health and Safety Code. Before issuing a permit, the Building Official shall collect a fee pursuant to Section 18.06.090 for maintaining construction documents that are required to be retained by this section.

EXCEPTIONS: Construction documents for the following need not be maintained, except where required by the Building Official:

1. Single or multiple dwellings in areas which are not part of a common interest development (as defined in Section 1351 of the California Civil Code), and not more than two (2) stories and basement in height;

2. Garages and other structures appurtenant to buildings described in Exception 1 of this subsection;
 3. Farm or ranch buildings; and
 4. Any one-story building where the span between bearing walls does not exceed twenty-five (25) feet. This exception does not, however, apply to a steel frame or concrete building.
- B. Inspection of construction documents. The copy of the approved construction documents maintained by the Building Official as provided by Subsection 18.05.070.A may be available for inspection only on the premises of the Building Official.

EXCEPTION: Construction documents for banks, other financial institutions or public utilities that are maintained by the Building Official may not be inspected without written permission from the owner of the building.

- C. Reproduction of construction documents. Construction documents maintained by the Building Official under Subsection 18.05.070.A may not be duplicated in whole or in part except with the written permission of the certified, licensed or registered professional or his or her successor, if any, who signed the original documents, and the written permission of the original or current owner of the building, or, if the building is part of a common interest development, with the written permission of the board of directors or governing body of the association established to manage the common interest development; upon request by any State agency; or by order of a proper court. In implementing this provision, the Building Official shall comply with the requirements of Section 19851 of the California Health and Safety Code.

The Building Official shall also furnish the form of an affidavit to be completed and signed by the person requesting to duplicate the official copy of the construction documents, which contains provisions stating the following:

1. That the copy of the construction documents shall only be used for the maintenance, operation and use of the building;
2. That drawings are instruments of professional service and are incomplete without the interpretation of the certified, licensed or registered professional of record; and
3. That Sections 5536.25(a) and 6735(b) of the California Business and Professions Code States that a registered design professional who signs construction documents shall not be responsible for damage caused by subsequent changes to, or use of, those construction documents where the subsequent changes or uses, including changes or uses made by State or local governmental agencies, are not authorized or approved by the registered design professional who originally signed the construction documents, provided that the service rendered by the registered design professional who signed the construction documents was not also a proximate cause of the damage.

The fees specified in the following item 1 or 2 shall be paid by the person requesting duplication of construction documents:

1. Construction documents that have not been microfilmed and are authorized for reproduction to be duplicated by other than City services will be released only to a Department authorized duplicating service. The person requesting duplication shall pay the cost of duplicating the construction documents directly to the duplicating service. That person shall pay a processing fee for each set of construction documents released to the Building Official as determined by Section 18.06.120.

2. Construction documents that have been microfilmed and are authorized for reproduction shall be duplicated by City services or vendors. The Building Official shall collect an initial service fee for each request for reproduction of construction documents plus an additional fee for each sheet requested to be photocopied as determined by Section 18.06.120.
- D. Withdrawal of construction documents. The Building Official shall not permit any original construction documents, or portions thereof upon which a permit has been issued, to be withdrawn from the office of the Building Official, except for official use by representatives of the City.

CHAPTER 18.06 FEES

- 18.06.010 – Permit fees.
- 18.06.020 – Plans examination fees.
- 18.06.030 – Plans re-examination fees.
- 18.06.040 – Re-inspection fee.
- 18.06.050 – Special inspection fee.
- 18.06.060 – Fees for verification reports.
- 18.06.070 – Investigation fees—Work without a permit.
- 18.06.080 – Code enforcement fees.
- 18.06.090 – Construction document maintenance fee.
- 18.06.100 – Board of appeals fees.
- 18.06.110 – Fee for verifying and reproducing permit records.
- 18.06.120 – Processing fee for reproducing construction document records.
- 18.06.130 – Oil and gas well record search.
- 18.06.140 – Oil or gas well abandonment.
- 18.06.150 – Service connection fee.
- 18.06.160 – Code modification and alternate fees.
- 18.06.170 – Transfer of permit fee.
- 18.06.180 – Temporary Certificate of Occupancy fee.
- 18.06.190 – Waiver of fees.
- 18.06.200 – Refunds.

CHAPTER 18.06 FEES

18.06.010 – Permit fees.

- A. Building permit fees. A building permit (exclusive of subtrade permits) shall be issued for each building or structure to be erected or upon which work is to be done thereunder when required pursuant to Section 18.04.010 and for each such permit the permit applicant shall pay a permit filing fee as set forth in the schedule of fees and charges established by City Council resolution plus a fee computed on the basis of the estimated total cost of the work proposed to be done, in accordance with the building permit fee as set forth in the schedule of fees and charges established by City Council resolution.

In addition to the above, projects regulated under Chapter 18.61 NPDES and SUSMP Regulations shall pay an additional fee as set forth in the schedule of fees and charges established by City Council resolution.

In addition to the above, projects regulated under Chapter 18.73 Flood Resistant Design and Construction shall pay an additional fee as set forth in the schedule of fees and charges established by City Council resolution.

In addition to the above, projects regulated under Chapter 18.74 Low Impact Development Standards shall pay an additional fee as set forth in the schedule of fees and charges established by City Council resolution.

In addition to the above, projects regulated under Sections 1.8.2.1.2 and 1.9.1 of Title 24, Part 2, of the California Code of Regulations, the State's Disabled Access and Adaptability Requirements, shall pay an additional fee as set forth in the schedule of fees and charges established by City Council resolution.

In addition to the above, projects regulated under Title 24, Part 6, of the California Code of Regulations, the State's Building Energy Efficiency Standards Code as developed by the California Energy Commission, shall pay an additional fee as set forth in the schedule of fees and charges established by City Council resolution.

In addition to the above, projects regulated under Chapter 1 of Title 24, Part 11, of the California Code of Regulations, the State's Green Building Standards Code, shall pay an additional fee as set forth in the schedule of fees and charges established by City Council resolution.

In addition to the above, projects regulated under Section 2700, Chapter 8, Division 2 of the California Public Resources Code, the State's Strong Motion Instrumentation Program, shall pay an additional fee as set forth in Section 2705, Chapter 8, Division 2 of the California Public Resources Code.

In addition to the above, projects regulated under Article 1-10 in Chapter 1 of Title 24, Part 1, of the California Code of Regulations, the State's Building Standards Administration Special Revolving Fund, shall pay an additional fee as set forth in Section 18931.6 of the California Health and Safety Code.

EXCEPTION: A single combined permit may be issued for the following:

1. The construction, addition or alteration of any building or structure of a one- or two-family dwelling and related accessory building and structure, which includes all building, electrical, plumbing, heating, ventilating, and air conditioning work; or
2. The construction, addition or alteration of any sign or sign support structure, which includes all building and electrical work.

The total permit fee for the combined building permit shall be as set forth in the schedule of fees and charges established by City Council resolution.

- B. Grading permit fees. A grading permit shall be issued to each property or site upon which grading work is to be done thereunder when required pursuant to Subsection 18.04.010.B, and for each such permit the permit applicant shall pay a filing fee as set forth in the schedule of fees and charges established by City Council resolution plus a grading permit fee computed on the basis of the estimated total cubic yard of work proposed to be done as set forth in the schedule of fees and charges established by City Council resolution.

In addition to the above, projects regulated under Chapter 18.61 NPDES and SUSMP Regulations shall pay an additional fee as set forth in the schedule of fees and charges established by City Council resolution.

In addition to the above, projects regulated under Chapter 18.74 Low Impact Development Standards shall pay an additional fee as set forth in the schedule of fees and charges established by City Council resolution.

- C. Electrical permit fees. An electrical permit shall be issued for each building or structure upon which work is to be done thereunder when required pursuant to Subsection 18.04.010.C, and for each such permit the permit applicant shall pay a permit filing fee as set forth in the schedule of fees and charges established by City Council resolution plus a fee computed on the basis of the proposed work to be done in accordance with the electrical permit fee as set forth in the schedule of fees and charges established by City Council resolution.

In addition to the above, projects regulated under Title 24, Part 6, of the California Code of Regulations, the State's Building Energy Efficiency Standards Code as developed by the California Energy Commission, shall pay an additional fee as set forth in the schedule of fees and charges established by City Council resolution.

In addition to the above, projects regulated under Chapter 1 of Title 24, Part 11, of the California Code of Regulations, the State's Green Building Standards Code, shall pay an additional fee as set forth in the schedule of fees and charges established by City Council resolution.

NOTE: For any electrical installation for which an electrical permit is required, but for which no fee is provided in this section, the electrical permit fee shall be based on the valuation of the electrical work and determined by Subsection 18.06.010.A.

Each point at which a lamp holding device, or group of lamp holding devices, is attached shall be considered to be an electrical outlet for which a fee is provided and required, and the lamp holding device shall be considered to be an electrical fixture for which a fee is provided and required.

- D. Plumbing permit fees. A plumbing permit shall be issued for each building or structure upon which work is to be done thereunder when required pursuant to Subsection 18.04.010.D, and for each such permit the permit applicant shall pay a permit filing fee as set forth in the schedule of fees and charges established by City Council resolution plus a fee computed on the basis of the proposed work to be done in accordance with the plumbing permit fee as set forth in the schedule of fees and charges established by City Council resolution.

In addition to the above, projects regulated under Chapter 1 of Title 24, Part 11, of the California Code of Regulations, the State's Green Building Standards Code, shall pay an additional fee as set forth in the schedule of fees and charges established by City Council resolution.

NOTE: For the purpose of this subsection, a plumbing outlet to which a fixture may be attached shall be considered a plumbing fixture, and any appliance or device which connects directly or

indirectly with the soil, waste or water system, or requires a trap or vent, shall be considered a plumbing fixture, and shall include water heaters, boilers and any type of water treating device.

- E. Mechanical permit fees. A mechanical permit shall be issued for each building or structure upon which work is to be done thereunder when required pursuant to Subsection 18.04.010.E, and for each such permit the permit applicant shall pay a permit filing fee as set forth in the schedule of fees and charges established by City Council resolution plus a fee computed on the basis of the proposed work to be done in accordance with the mechanical permit fee as set forth in the schedule of fees and charges established by City Council resolution.

In addition to the above, projects regulated under Title 24, Part 6, of the California Code of Regulations, the State's Building Energy Efficiency Standards Code as developed by the California Energy Commission, shall pay an additional fee as set forth in the schedule of fees and charges established by City Council resolution.

In addition to the above, projects regulated under Chapter 1 of Title 24, Part 11, of the California Code of Regulations, the State's Green Building Standards Code, shall pay an additional fee as set forth in the schedule of fees and charges established by City Council resolution.

- F. Sign permit fees. A sign permit shall be issued for each sign or sign support structure to be erected or upon which work is to be done thereunder when required pursuant to Subsection 18.04.010.G, and for each such permit the permit applicant shall pay a filing fee as set forth in the schedule of fees and charges established by City Council resolution plus a sign permit fee computed on the basis of the estimated total cost of the work proposed to be done as set forth in the schedule of fees and charges established by City Council resolution.

In addition to the above, projects regulated under Title 24, Part 6, of the California Code of Regulations, the State's Building Energy Efficiency Standards Code as developed by the California Energy Commission, shall pay an additional fee as set forth in the schedule of fees and charges established by City Council resolution.

- G. Determining valuation. The determination of value or valuation under any of the provisions of this title shall be made by the Building Official. The value to be used in computing the permit and plan examination fees shall be the total value of all construction work for which the permit is issued as well as all finish work, painting, roofing, electrical, plumbing, heating, air conditioning, elevators, fire extinguishing systems and any other permanent equipment.

No person shall willfully or negligently withhold from or misrepresent to the Building Official any information he or she may request relative to the estimated cost of any proposed work for which an application for a permit has been filed, or misrepresent the cost of any such work. The determination or collection of fees based upon incorrect information and other data supplied by the permit applicant shall not prevent the Building Official from subsequently requiring the correction of the error in determining or collecting the appropriate fees.

18.06.020 – Plans examination fees.

Except where the Building Official has determined that the submittal of construction documents and other data are not required if the Building Official finds that the nature of the work applied for is such that the examination of construction documents is not necessary to obtain compliance with this title, plans examination and the fees for such examination shall be required for the following:

- A. Buildings and structures plans examination fees. Except as provided in this section, the permit applicant for a building permit shall, in addition to the fee prescribed therefore and at the time of making application for such building permit, pay a plans examination fee as set forth in the schedule of fees and charges established by City Council resolution, including the filing fee. The plans examination fee for a combined permit shall be as set forth in the schedule of fees and charges established by City Council resolution for a building permit of the same valuation.

In addition to the above, projects regulated under Chapter 18.61 NPDES and SUSMP Regulations shall pay an additional fee as set forth in the schedule of fees and charges established by City Council resolution.

In addition to the above, projects regulated under Chapter 18.73 Flood Resistant Design and Construction shall pay an additional fee as set forth in the schedule of fees and charges established by City Council resolution.

In addition to the above, projects regulated under Chapter 18.74 Low Impact Development Standards shall pay an additional fee as set forth in the schedule of fees and charges established by City Council resolution.

In addition to the above, projects regulated under Sections 1.8.2.1.2 and 1.9.1 of Title 24, Part 2, of the California Code of Regulations, the State's Disabled Access and Adaptability Requirements, shall pay an additional fee as set forth in the schedule of fees and charges established by City Council resolution.

In addition to the above, projects regulated under Title 24, Part 6, of the California Code of Regulations, the State's Building Energy Efficiency Standards Code as developed by the California Energy Commission, shall pay an additional fee as set forth in the schedule of fees and charges established by City Council resolution.

In addition to the above, projects regulated under Chapter 1 of Title 24, Part 11, of the California Code of Regulations, the State's Green Building Standards Code, shall pay an additional fee as set forth in the schedule of fees and charges established by City Council resolution.

EXCEPTIONS: No plans examination fee shall be required when the Building Official has determined that the submittal of construction documents and other data are not required if it is found that the nature of the work applied for is such that the examination of construction documents is not necessary to obtain compliance with this title.

- B. Grading plans examination fees. The permit applicant for a grading permit shall, in addition to the fee prescribed therefore and at the time of making application for such grading permit, pay a plans examination fee to the City as set forth in the schedule of fees and charges established by City Council resolution, including the filing fee.

In addition to the above, projects regulated under Chapter 18.61 NPDES and SUSMP Regulations shall pay an additional fee as set forth in the schedule of fees and charges established by City Council resolution.

- C. Electrical plans examination fees. The permit applicant for an electrical permit shall, in addition to the fee prescribed therefore and at the time of making application for such electrical permit, pay a plans examination fee to the City as set forth in the schedule of fees and charges established by City Council resolution, including the filing fee.

In addition to the above, projects regulated under Title 24, Part 6, of the California Code of Regulations, the State's Building Energy Efficiency Standards Code, developed by the California Energy Commission shall pay an additional fee as set forth in the schedule of fees and charges established by City Council resolution.

- D. Plumbing plans examination fees. The permit applicant for a plumbing permit shall, in addition to the fee prescribed therefore and at the time of making application for such plumbing permit, pay a plans examination fee to the City as set forth in the schedule of fees and charges established by City Council resolution, including the filing fee.

In addition to the above, projects regulated under Sections 1.8.2.1.2 and 1.9.1 of Title 24, Part 2, of the California Code of Regulations, the State's Disabled Access and Adaptability Requirements, shall pay an additional fee as set forth in the schedule of fees and charges established by City Council resolution.

In addition to the above, projects regulated under Chapter 1 of Title 24, Part 11, of the California Code of Regulations, the State's Green Building Standards Code, shall pay an additional fee as set forth in the schedule of fees and charges established by City Council resolution.

- E. Mechanical plans examination fees. The permit applicant for a mechanical permit shall, in addition to the fee prescribed therefore and at the time of making application for such mechanical permit, pay a plans examination fee to the City as set forth in the schedule of fees and charges established by City Council resolution, including the filing fee.

In addition to the above, projects regulated under Title 24, Part 6, of the California Code of Regulations, the State's Building Energy Efficiency Standards Code, developed by the California Energy Commission shall pay an additional fee as set forth in the schedule of fees and charges established by City Council resolution.

In addition to the above, projects regulated under Chapter 1 of Title 24, Part 11, of the California Code of Regulations, the State's Green Building Standards Code, shall pay an additional fee as set forth in the schedule of fees and charges established by City Council resolution.

- F. Signs and sign support structures plans examination fees. The permit applicant for a sign permit shall, in addition to the fee prescribed therefore and at the time of making application for such sign permit, pay a plans examination fee to the City as set forth in the schedule of fees and charges established by City Council resolution, including the filing fee.

In addition to the above, projects regulated under Title 24, Part 6, of the California Code of Regulations, the State's Building Energy Efficiency Standards Code, developed by the California Energy Commission shall pay an additional fee as set forth in the schedule of fees and charges established by City Council resolution.

- G. Express plans examination fees. At the request of the permit applicant, the Building Official may, at his or her discretion, provide plans examination services at other than normal working hours. An express plans examination fee, in addition to the plans examination fees charged elsewhere in this title, as set forth in the schedule of fees and charges established by City Council resolution shall be collected at the time of the request.

- H. Geologic reports review fees. A fee as set forth in the schedule of fees and charges established by City Council resolution shall be charged for the review of geologic, soils engineering or geotechnical engineering reports submitted as required by State law for proposed development in seismic hazard zones, including but not limited to, fault rupture, liquefaction and landslide hazard zones or Section 18.05.030.A Item 14.

18.06.030 – Plans re-examination fees.

When required by Section 18.05.040, the permit applicant shall pay a plan re-examination fee as set forth in the schedule of fees and charges established by City Council resolution. The plan re-examination fee in the case of a building, sign or subtrade permit shall be based on a rate as set forth in the schedule of fees and charges established by City Council resolution and the plan examination fee for a grading permit shall be as set forth in the schedule of fees and charges established by City Council resolution for the number of cubic yards replaced, removed or omitted that were not previously approved.

18.06.040 – Re-inspection fee.

When required by Section 18.07.030, the permit applicant shall pay a re-inspection fee as set forth in the schedule of fees and charges established by City Council resolution.

18.06.050 – Special inspection fee.

- A. General. Upon request, the Building Official will make special inspections provided:
1. The permit applicant makes accessible and exposes elements or structures inspected;
 2. That the permit applicant pays a fee as set forth in the schedule of fees and charges established by City Council resolution for the following:
 - a. Building inspection,
 - b. Plumbing inspection,
 - c. Electrical inspection,
 - d. Mechanical inspection,
 - e. Housing inspection (dwellings),
 - f. Code inspection for business license,
 - g. Non-team inspection,
 - h. Team inspection,
 - i. Condominium conversion inspections,
 - j. Site inspection not otherwise covered.
- B. Additional inspection fee. A fee as set forth in the schedule of fees and charges established by City Council resolution per hour or fraction thereof shall be charged for inspections requiring in excess of one (1) hour.

EXCEPTION: Within the scope of the special inspections, the Building Official may approve minor corrections or alterations involving work of a building, plumbing, mechanical or electrical nature with an aggregate total cost of two thousand dollars (\$2,000.00) or less.

- C. Off-hour inspection fee. For inspections performed on request at other than normal office hours, a fee as set forth in the schedule of fees and charges established by City Council resolution.

18.06.060 – Fees for verification of reports.

- A. Special inspection supervision fee. To supervise the performance of registered special inspectors required to be employed for certain types of work as provided by Section 18.07.080, a fee as set forth in the schedule of fees and charges established by City Council resolution for each type of work shall be paid at the time of permit issuance.
- B. Structural observation report fee. To verify that all structural observation reports required by Section 1704.5 of the California Building Code adopted in Chapter 18.40 have been received prior to the issuance of a Certificate of Occupancy, a fee as set forth in the schedule of fees and charges established by City Council resolution shall be paid at the time of permit issuance.

18.06.070 - Investigation fees—Work without a permit.

- A. Investigation. Whenever any work for which a permit is required by this title has been commenced without first obtaining such permit, a special investigation shall be made before a permit may be issued for such work.
- B. Fee. An investigation fee, in addition to the permit fee, shall be collected whether or not a permit is then or subsequently issued. The investigation fee shall be equal to the amount of the permit fee required by this title with a minimum fee as set forth in the schedule of fees and charges established by City Council resolution. The payment of such investigation fee shall not exempt any person, firm or corporation from compliance with all other provisions of this title, municipal code or other ordinances of the City or laws and statutes of the State nor from any penalty prescribed by law.

EXCEPTION: The investigation fee may be waived for emergency work when it is proved to the satisfaction of the Building Official that such work was urgently needed and it was impractical to obtain a permit prior to commencement of the work.

18.06.080 – Code enforcement fees.

- A. Purpose. The City incurs an extraordinary cost whenever it becomes necessary to undertake code enforcement proceedings to abate a substandard or dangerous property condition. The purpose of the code enforcement fee as required by this section is to recover a portion of these incurred costs.
- B. When required. Whenever a building permit is required to abate a substandard or dangerous condition as ordered by the Building Official, a code enforcement fee shall be paid in addition to the permit fee. The special code enforcement fee shall not be required if the abatement order of the Building Official is reversed on appeal to the Board of Examiners, Appeals and Condemnation, or by subsequent appeal to City Council, or by final subsequent appeal to City Council, or by final judgment of a court of competent jurisdiction.
- C. Fee. The code enforcement fee required by this title is as set forth in the schedule of fees and charges established by City Council resolution. The payment of the code enforcement fee shall not exempt any person, firm or corporation from compliance with all other provisions of this code nor from any penalty prescribed by law.

18.06.090 – Construction document maintenance fee.

Before issuing a permit, the Building Official shall collect a fee for maintaining construction documents that are required to be retained by Section 18.05.070. The amount of the construction document maintenance fee shall be as set forth in the schedule of fees and charges established by City Council resolution and shall be collected for each separate construction documents to be retained by the Building Official.

18.06.100 – Board of appeals fees.

- A. Board of Examiners, Appeals and Condemnation fee. A fee as set forth in the schedule of fees and charges established by City Council resolution shall be charged to a person appealing to the Board of Examiners, Appeals and Condemnation pursuant to Section 18.10.020 the action of the Building Official in enforcing or interpreting the provisions of this title, including determinations relative to correction of substandard conditions in buildings and to abate nuisances.

EXCEPTION: For appeal involving condemnations and from corrective notices as provided for in this title, there shall be no required fee.

- B. Disabled Access Appeals Board fee. A fee as set forth in the schedule of fees and charges established by City Council resolution shall be charged to a person appealing to the Disabled Access Appeals Board pursuant to Section 18.10.030 the action of the Building Official in

enforcing Title 24, Part 2, of the California Code of Regulations, the State's Disabled Access and Adaptability Requirements.

18.06.110 – Fee for verifying and reproducing permit records.

A fee will be charged to verify permit and inspection records, including age of building. Reproduction of permit records may be obtained for a fee. The fee is as set forth in the schedule of fees and charges established by City Council resolution.

18.06.120 – Processing fee for reproducing construction document records.

A processing fee as set forth in the schedule of fees and charges established by City Council resolution shall be charged to process a request for a copy of construction documents on record. A separate processing fee shall be paid for each construction document or set of construction documents involving a single site. The processing fee shall be in addition to fees charged to cover duplicating costs.

18.06.130 – Oil and gas well record search.

A fee as set forth in the schedule of fees and charges established by City Council resolution for each lot or parcel located in an oil zone shall be charged for a record search to determine the existence and location of subsurface gas or oil wells.

18.06.140 – Oil or gas well abandonment.

A fee as set forth in the schedule of fees and charges established by City Council resolution shall be charged for the inspections required during the abandonment of an oil or gas well.

18.06.150 – Service connection fee.

When electrical connection by the utility company is necessary to supply such temporary use, the owner of the building or a duly authorized representative shall make application and pay a fee as set forth in the schedule of fees and charges established by City Council resolution for each service connection.

Each meter and meter switch is considered a separate service. The Building Official may impose such reasonable requirements and regulations in connection therewith as he or she may deem necessary.

18.06.160 – Code modification and alternate fees.

A. Code modification fee. A written application for code modification pursuant to Section 18.03.050 shall be submitted together with a filing fee as set forth in the schedule of fees and charges established by City Council resolution. An additional fee as set forth in the schedule of fees and charges established by City Council resolution per hour or fraction thereof shall be charged when staff review time exceeds one (1) hour.

B. Code alternate fee. A written application for alternate materials, design and methods of construction or equipment pursuant to Section 18.03.060 shall be submitted together with a filing fee as set forth in the schedule of fees and charges established by City Council resolution. An additional fee as set forth in the schedule of fees and charges established by City Council resolution per hour or fraction thereof shall be charged when actual staff review time exceeds one (1) hour.

EXCEPTION: The requirement for application and fees and charges may be waived by the Building Official for materials, products or methods which have been evaluated and listed by the International Code Council, the national research board, or other recognized agency.

18.06.170 – Transfer of permit fee.

Active permits transferred pursuant to Subsection 18.04.060.E shall pay a permit transfer fee as set forth in the schedule of fees and charges established by City Council resolution.

18.06.180 – Temporary Certificate of Occupancy fee.

Permit applicants requesting a Temporary Certificate of Occupancy pursuant to Section 18.08.040 shall pay an investigation fee as set forth in the schedule of fees and charges established by City Council resolution for which approval of temporary occupancy is sought with the minimum fee as set forth in the schedule of fees and charges established by City Council resolution. An additional investigation fee shall be paid to extend a Temporary Certificate of Occupancy beyond thirty (30) days in an amount as set forth in the schedule of fees and charges established by City Council resolution of the initial investigation fee as set forth in the schedule of fees and charges established by City Council resolution for each additional thirty (30) day period or fraction thereof.

18.06.190 – Waiver of fees.

The Director may waive any application fee imposed on or after October 1, 1996 pursuant to the provisions of this title or municipal code if the Director first finds as follows:

1. A permit has been issued which does not fully conform to the provisions of this title, municipal code or other ordinances of the City or laws and statutes of the State; and
2. There is no evidence that the permit applicant, in seeking the permit intentionally sought to avoid conformance to the provisions of this title, municipal code or other ordinances of the City or laws and statutes of the State; and
3. Substantial construction commenced in good faith reliance on that permit; and
4. Stoppage has been ordered subsequent to such commencement as a result of the failure of the permit to conform to the provisions of this title, municipal code or other ordinances of the City or laws and statutes of the State; and
5. The application or applications for which a fee waiver is requested and granted are necessary in order to authorize the issuance of the permit in a manner fully conforming to the provisions of this title, municipal code or other ordinances of the City or laws and statutes of the State.

18.06.200 – Refunds.

- A. General. No portion of any permit as required in this title shall be refunded to the permit applicant unless, prior to commencement of actual work thereunder, the proposal to do such work is abandoned, or it is discovered that such permit is void under provisions of this title, municipal code or other ordinances of the City. No portion of a checking fee shall be refunded to the permit applicant if any checking of the construction documents has been done in the office of the Building Official.
- B. Condition. Refunds shall be made in the calculated amount so determined in this section and under the conditions set forth in Sections 3.48.040 and 3.48.060 of the municipal code.
- C. Administration fee. Before any refund is made under this chapter, the Building Official shall deduct a percent as set forth in the schedule of fees and charges established by City Council resolution of the fee paid to pay for expenses incurred by the City in connection with accepting the construction documents, passing upon the application for or issuance of the permit, and the sum shall be deducted from the fee so paid and the balance paid to such person. If the person

entitled to the refund is an individual and such person becomes deceased, the refund may be made to such person or persons entitled to receive the money.

- D. Expiration. Any application for refund must be filed by the person entitled to receive such refund within the prescribed expiration period in Subsection 18.06.200.B.

CHAPTER 18.07 INSPECTIONS

- 18.07.010 – General.
- 18.07.020 – Inspection record card.
- 18.07.030 – Inspection requests.
- 18.07.040 – Approval required.
- 18.07.050 – Required inspections.
- 18.07.060 – Surveys.
- 18.07.070 – Noninspected work.
- 18.07.080 – Special inspections.

CHAPTER 18.07 INSPECTIONS

18.07.010 – General.

- A. **Inspection.** All construction or work for which a permit is required shall be subject to inspection by Section 18.07.050 and such construction or work shall remain accessible and exposed for inspection purposes until approved. Certain types of construction shall have special inspections by registered special inspectors as specified in Section 18.07.080 and Section 1704 of the California Building Code adopted in Chapter 18.40. Prior to the issuance of a Certificate of Occupancy as specified in Section 18.08.010, a final inspection in accordance with Section 18.07.050 shall be made by the Building Official of all construction or work for which a permit has been issued.
- B. **Liability.** Neither the Building Official, authorized employees of the Department, nor the City shall be liable for expense entailed in the removal or replacement of any material required to allow inspection.

18.07.020 – Inspection record card.

The Building Official shall furnish with each permit an inspection record card to be posted in a conspicuous place on the front premises (or electric meter box) and in such position as to allow the Building Official to conveniently make the required entries thereon regarding inspection of the work. The inspection record shall show the location, nature of work to be done, the number of the permit and list the required inspections.

When any of the required inspections pursuant to Section 18.07.050 have been made and that portion of the work is approved, the inspector shall so record on the permit card posted on the job.

18.07.030 – Inspection requests.

- A. **General inspection request.** It is the duty of the permit holder or their duly authorized agent to notify the Building Official when work is ready for inspection and to provide access to and means for inspections of such work that are required by this title. The Building Official may require that every request for inspection be filed at least one (1) working day before such inspection is desired. Such request may be in writing, by telephone or by other means at the option of the Building Official.
- B. **Re-inspection request.** To obtain a re-inspection, the permit applicant shall request such inspection pursuant to Subsection 18.07.030.A. A re-inspection fee in Section 18.06.040 may be charged for the following:
 - 1. For each inspection or re-inspection when the portion of work for which the inspection or re-inspection is called is not complete or when the correction called for is not made.

NOTE: This section is not to be interpreted as requiring re-inspection fees the first time a job is rejected for failure to comply with the requirements of this title, but as controlling the practice of calling for inspections before the job is ready for such inspection or re-inspection.

- 2. When the permit card is not properly posted on the work site, the approved construction documents are not readily available to the inspector, for failure to provide access on the date for which inspection is requested, or for deviating from the approved construction documents requiring the approval of the Building Official.

In instances where re-inspection fees have been assessed, no additional inspection of the work will be performed until the required fees have been paid.

18.07.040 – Approvals required.

No work shall be done on any part of the building or structure beyond the point indicated in each successive inspection without first obtaining the written approval of the Building Official. The Building Official, upon notification pursuant to Section 18.07.030 by the person, firm or corporation performing the work, shall make the requested inspections and shall either indicate the portion of the construction that is satisfactory as completed, or notify the permit holder or their duly authorized agent wherein the same fails to comply with the provisions of this title, municipal code or other ordinances of the City or laws and statutes of the State. Any portions that do not comply shall be corrected and such portion shall not be covered or concealed until authorized by the Building Official. Such written approval shall be given only after an inspection has been made of each successive step in the construction as indicated by each of the inspections required or conditions stipulated in Section 18.07.050. There shall be a final inspection and approval on all buildings or equipment installations when completed and ready for occupancy or use.

EXCEPTIONS:

1. For temporary connection, the Building Official may give written permission to furnish electric current to or the use of electric current through any electrical wiring if such electrical wiring may be used safely for such purposes, and that there exists an urgent necessity for such use.
2. The requirements of this section shall not be considered to prohibit the operation of any heating equipment installed to replace existing heating equipment serving an occupied portion of a building, in the event a request for inspection of such heating equipment has been filed with the Building Official not more than forty-eight (48) hours after such replacement work is completed, and before any portion of such equipment is concealed by any permanent portion of the building.

18.07.050 – Required inspections.

- A. Building. The Building Official, upon notification as specified in Section 18.07.030, shall make the inspections set forth in items 1 through 13, if applicable.
 1. Footing and foundation inspection. Footing and foundation inspections shall be made after excavations for footings are complete and any required reinforcing steel is in place. For concrete foundations, any required forms shall be in place prior to inspection. Materials for the foundation shall be on the job, except where concrete is ready mixed in accordance with ASTM C 94, the concrete need not be on the job.
 2. Concrete slab and under-floor inspection. Concrete slab and under-floor inspections shall be made after all in-slab or under-floor reinforcing steel and building service equipment, conduit, piping accessories and other ancillary equipment items are in place, but before any concrete is placed or floor sheathing installed, including the subfloor.
 3. Lowest floor elevation. In flood hazard areas, upon placement of the lowest floor, including the basement, and prior to further vertical construction, the elevation certification required in Chapter 18.73 Flood Resistant Design and Construction or Section 1612.5 of the California Building Code adopted in Chapter 18.40 shall be submitted to the Building Official. A final elevation certification shall be submitted to the Building Official prior to making a request for final inspection.
 4. Frame inspection. Framing inspections shall be made after the roof deck or sheathing, all framing, fire blocking and bracing are in place and all pipes, chimneys and vents to be concealed are complete and the rough electrical, plumbing, heating wires, pipes and ducts are approved.

5. Lath and gypsum board inspection. Lath and gypsum board inspections shall be made after lathing and gypsum board, interior and exterior, are in place, but before any plastering is applied or gypsum board joints and fasteners are taped and finished.
 6. Fire- and smoke-resistant penetrations. Protection of joints and penetrations in fire resistance-rated assemblies, smoke barriers and smoke partitions shall not be concealed from view until inspected and approved.
 7. Energy efficiency inspections. Inspections shall be made to determine compliance with the California Energy Code adopted in Chapter 18.46 and shall include, but not be limited to, inspection for: envelope insulation R- and U-values, fenestration U-value, duct system R-value, and HVAC and water-heating equipment efficiency.
 8. Reinforced concrete. When forms and reinforcing steel are in place ready for concrete.
 9. Reinforced masonry. In grouted masonry when vertical reinforcing steel is in place and other reinforcing steel distributed and ready for placing, but before any units are laid up.
 10. Structural steel. When structural steel members are in place and required connections are complete, but before concealing any members or connection.
 11. Other inspections. In addition to the inspections specified above, the Building Official is authorized to make or require other inspections of any construction work to ascertain compliance with the provisions of this title and other laws that are enforced by the Building Official.
 12. Special inspections. For special inspections, see Section 1704 of the California Building Code adopted in Chapter 18.40.
 13. Final inspection. Final inspection shall be made after all work required by the permit is completed and prior to occupancy.
- B. Electrical. The Building Official, upon notification as specified in Section 18.07.030, shall make the inspection and approval of electrical installation as set forth in items 1 through 9, if applicable.
1. Inspection required. All electric wiring or installation in or on any building or structure of any nature, or tent, or premises, except as otherwise exempted in this title, for which a permit is required must be inspected and approved by the Building Official before being energized or used.
 2. Prohibited use, operation or maintenance. No person shall use, operate or maintain, or cause or permit to be used, operated or maintained, any such electric wiring until such inspection and approval. No serving agency shall furnish or supply or cause or permit to be furnished or supplied, electric energy to any such electric wiring until such inspection and approval.
 3. Prohibited concealment or enclosure of electrical wiring. No person shall conceal, enclose or cover, or cause or permit to be concealed, enclosed or covered, any portion of any electric wiring in any manner that will interfere with or prevent the inspection and approval thereof.
 4. Prohibited obstruction to inspection. Any portion of any floor, ceiling, wall, partitions, roof, finish or other obstruction whatsoever which renders impracticable the making of a complete and thorough inspection of electric wiring shall be removed upon notice to do so, and shall be kept removed until such electric wiring has been inspected and approved.
 5. Removal of foreign material in box and wire enclosure. Before a final inspection of any electric wiring, all plaster, concrete or other foreign material shall be thoroughly removed from every box and wiring enclosure, and not less than six (6) inches of jointless conductors shall

- extend out of each lighting outlet box for future connection thereto, except when conductors are intended to loop through the lamp holder.
6. Fixture connection. Fixtures or appliances shall not be connected to electric wiring until the rough wiring has been inspected and approved by the Building Official.
 7. Free of defects. All such wiring shall be free from grounds, shorts, or other defects, before approval thereof.
 8. Exemption. The provisions of this subsection shall not apply to finished work or to conductors inserted in conduit or other wiring enclosures. Nothing contained in this subsection shall be construed to prohibit the temporary use of electric energy when and as specifically provided in this title. Nothing contained in this subsection shall be construed to prohibit the inspection of any electric wiring even though no permit is required therefore.
 9. Final inspection. Final inspection shall be made after all work required by the permit is completed and found to be in compliance with the provisions of this title, the Building Official shall leave a notice at the service switch or other suitable place so stating, and shall issue a certificate of inspection or approval tag when requested, or service permit, authorizing the connection to the electrical service and the energizing of the installation.
- C. Plumbing. The Building Official, upon notification as specified in Section 18.07.030, shall make the inspection and approval of plumbing installation as set forth in items 1 through 6, if applicable.
1. Inspection required. All plumbing installation in or on any building or structure of any nature, or tent, or premises, except as otherwise exempted in this title, for which a permit is required must be inspected and approved by the Building Official.
 2. Gas supply or meter. No person shall furnish or supply gas to any gas piping or install any meter therefore until all plumbing as regulated by this title has been installed and approved by the Building Official and a certificate of final inspection has been issued.

EXCEPTION: Notwithstanding anything in this chapter to the contrary, gas service may be supplied to gas piping for construction purposes only and a gas meter may be installed therefore under the following conditions:

- a. The owner of the building or a duly authorized representative shall apply to the Building Official for such gas service and shall pay a fee as set forth in the schedule of fees and charges established by City Council resolution in connection with such application to the Building Official. The application for such gas service shall not be granted until all gas piping in the structure affected has been tested and approved pursuant to the California Plumbing Code adopted in Chapter 18.44.
 - b. Such service shall not be permitted for an initial period in excess of thirty (30) days. The Building Official may impose such reasonable requirements and regulations in connection therewith as he or she may deem necessary. For good cause, the Building Official may extend such period of time in his or her reasonable discretion.
3. Prohibited concealment of installation. No person shall fail, neglect or refuse to leave and keep any plumbing, as regulated by this title, open, uncovered and convenient for inspection until such plumbing has been inspected and approved by the Building Official, and any obstruction whatsoever, which interfered with a complete and thorough inspection of any plumbing, shall be removed upon notice so to do, and shall be left and kept removed until such plumbing has been inspected and approved.
 4. Location of installation. Piping, fixtures or equipment shall not be located in such manner as to interfere with the normal operation of windows, doors or other required means of access.

5. Services to be capped when building removed. Where a building is demolished or removed from its site, the building sewer, water and gas service shall be properly capped to the satisfaction of the Building Official.
 6. Final inspection. Final inspection shall be made after all work required by the permit is completed and found to be in compliance with the provisions of this title, the Building Official shall leave a notice at a suitable place so stating, and when requested shall authorize the furnishing or supplying of gas to any gas piping or the installation of any meter.
- D. Mechanical. The Building Official, upon notification as specified in Section 18.07.030, shall make the inspection and approval of mechanical installation as set forth in items 1 through 5, if applicable.
1. Inspection required. All mechanical installation in or on any building or structure of any nature, or tent, or premises, except as otherwise exempted in this title, for which a permit is required must be inspected and approved by the Building Official.
 2. Prohibited concealment of installation. That portion of any equipment intended to be concealed by any permanent portion of the building shall not be concealed until inspected and approved by the Building Official.
 3. Connection to fuel or power supply. Equipment regulated by this title shall not be connected to the fuel or power supply until authorized by the Building Official.
 4. Failure to comply. A final inspection approval may, upon notice, be revoked by the Building Official if he or she finds that the heating, ventilating, cooling, or refrigeration equipment fails in any respect to comply with the requirements of this title, or that the installation is unsafe, dangerous, or a hazard to life or property.
 5. Final inspection. Final inspection shall be made after all work required by the permit is completed and found to be in compliance with the provisions of this title, the Building Official shall leave a notice at a suitable place so stating, and shall authorize the connection to the fuel or power supply for the installation.
- E. Grading. The Building Official, upon notification as specified in Section 18.07.030, shall make the inspection and approval of grading, excavations or fills operation as set forth in items 1 through 7, if applicable:
1. Initial meeting/inspection. When the permit holder or their duly authorized agent is ready to begin work, but before any grading operation or brushing is started, a meeting shall be held at the project site with the contractor and the inspectors to discuss the approved construction documents, soil reports and the sequence of the grading operations.
 2. Toe inspection. After the natural ground is exposed and prepared to receive fill, but before any fill is placed.
 3. Excavation inspection. After the excavation is started, but before the vertical depth of the excavation exceeds ten (10) feet.
 4. Fill inspection. After the fill placement is started, but before the vertical height of the lifts exceeds ten (10) feet.
 5. Drainage device inspection. After forms and pipes are in place, but before any concrete is placed.

6. Rough grading. When all rough grading has been completed. This inspection may be called for at the completion of the rough grading without the necessity of the Building Official having previously reviewed and approved reports.
7. Final. When all work, including installation of all drainage structures or other protective devices, has been completed and the as-graded construction document and required reports have been submitted.

18.07.060 – Surveys.

In the absence of any designation of the proper location of the lot on which a building or structure is to be erected, for which building a permit has been issued, the Building Official may require the permit holder or their duly authorized agent to have the lot surveyed and staked by a registered land surveyor or registered civil engineer licensed in the State of California to practice as such so that the proper location of the building or structure on the lot may be determined and to verify compliance of the building or structure with the approved construction documents.

18.07.070 – Non-inspected work.

No person, firm or corporation shall own, use, occupy or maintain any building or structure on which non-inspected work has been performed. For the purpose of this title, "non-inspected work" shall be defined as and include but not limited to any erection, construction, enlargement, alteration, repair, remodel, movement, removal, improvement, conversion or demolition for which a permit was first obtained, but which has progressed beyond the point indicated in successive inspections, including, but not limited to, inspections as set forth in Section 18.07.050 and Chapter 17 of the California Building Code adopted in Chapter 18.40, without first obtaining inspection by and approval of the Building Official.

18.07.080 – Special inspections.

- A. When required. In addition to the inspections to be made by the Building Official as specified in this chapter, the owner or the registered design professional in responsible charge acting as the owner's agent shall employ one (1) or more special inspectors who shall provide inspections during construction on the types of work listed under Section 1704 of the California Building Code adopted in Chapter 18.40. The special inspector shall be qualified under Subsection 18.07.080.B. The special inspector may be employed either directly or through the architectural or engineering firm in charge of the design of the structure, or through the geologic or soils engineering firm providing technical design data for the project, or through an independent approved inspection/test firm. In any case, the special inspector shall be approved by and shall be responsible to the architectural or engineering firm in charge of the design of the structure, or the geologic or soils engineering firm providing technical design data for the project.
- B. Qualifications of special inspector. The registered special inspector shall be a qualified person who shall demonstrate his or her competence pursuant to Subsection 18.07.080.C, to the satisfaction of the Building Official, for inspection of the particular type of construction or operation requiring special inspection.
- C. Examination and certificate.
 1. Requirement. Any person desiring to be registered as a registered inspector shall first qualify by passing a written or oral examination or both, given by the Building Official. Upon application for such examination, such person shall pay to the City a nonrefundable registration fee as set forth in the schedule of fees and charges established by City Council resolution.

2. Certificate. Every applicant passing such examination shall be issued a certificate as a registered inspector upon payment of a fee as set forth in the schedule of fees and charges established by City Council resolution.
 3. Expiration. All certificates issued by the Building Official shall expire three (3) year from the date issued, and may be renewed from year to year upon the payment of an annual fee as set forth in the schedule of fees and charges established by City Council resolution. Application for renewal shall be made within thirty (30) days following the date of expiration. Expired certificates may be renewed within sixty (60) days following the date of expiration; provided, that the renewal fee shall be as set forth in the schedule of fees and charges established by City Council resolution. After a certificate has expired, it shall not be renewed, and an application, nonrefundable fee and a reexamination will be required.
- D. Revocation of registration. The Building Official may revoke the registration of any registered special inspector, or the assignment of such registered special inspector to any particular building or structure, for incompetency or failure to conscientiously carry out his or her duties as specified in Subsection 18.07.080.E, in which event the Building Official may stop all further work upon the building or structure involved until some other person has been qualified, registered and assigned thereto by the Building Official.
- E. Duties of special inspector.
1. Time at the jobsite. The registered special inspector shall be employed on the work, without expense or liability to the City, either on a full time or part time basis, depending upon the magnitude of the work as determined by the Building Official. The determination of the percentage of time necessary for the job shall be left to the discretion of the registered special inspector, subject to approval of the Building Official.
 2. Responsibility. The registered special inspector shall bear a joint responsibility to the owner, or his or her agent, and the Building Official. He or she shall, for no purpose, be deemed an employee of the City, the contractor, a subcontractor or a material vendor. The assignments of the registered special inspector to each job shall be reported to the Building Official before commencing work.
 3. Duties. In addition to required verification and inspection specified in Section 1704 of the California Building Code adopted in Chapter 18.40, the registered special inspector shall observe the work assigned to be certain it conforms to the approved construction documents. On such building or structure it shall be the duty of every registered special inspector to inspect carefully all materials proposed to be used in connection with any work covered by any permit issued by the Building Official, and the registered special inspector shall obtain full information regarding the strength and durability of new types of materials where their use involves structural safety. He or she shall make such reports in writing as may be required by the Building Official regarding the progress of the work, and any deviations, defects, delays, materials, working conditions and other matters which may in any manner affect the structural safety and strength of the building. He or she shall be directly responsible for enforcing all other ordinances and laws applicable to the work to which he or she is assigned.
 4. Inspection report. The registered special inspector shall furnish inspection reports to the Building Official, the registered design professional in responsible charge and other designated persons. All discrepancies shall be brought to the immediate attention of the contractor for correction; then, if uncorrected, to the proper design authority and to the Building Official. He or she shall notify the Building Official of any attempt to cover, conceal, patch or repair any defect in materials or workmanship, and he or she shall report every infraction of any ruling of the Building Official. In furtherance of his or her aforesaid duties, he or she shall have the authority to compel the removal of defective materials and the correction of defective workmanship, or to suspend or stop further work pending a ruling of the Building Official.

5. Final report. The registered special inspector shall submit a final signed report stating whether the work requiring special inspection was, to the best of his or her knowledge, in conformance with the approved construction documents and the applicable workmanship provisions of this title.
- F. Termination of duties.
1. Termination. Every registered inspector shall remain constantly upon the work to which he or she is assigned during the process of construction, and unless otherwise removed from the job, his or her duties shall terminate only when a certificate of compliance is issued by him or her and approved by the Building Official. Such certification of compliance shall bear a statement signed by the registered inspector stating that the work upon the building or structure to which he or she has been assigned has been completed in a satisfactory manner and that the regulations of this title affecting the structural features of such building or structure have been fully complied with. If there have been any infractions of this title, they shall be noted in this statement.
 2. Certificate of compliance. The Building Official shall approve such certificate of compliance filed by the registered inspector if after inspection the structural features of such building or structure are found to be in accordance with the provisions of this chapter. Each certificate of compliance shall bear the legal description of the property upon which such building or structure is located and an identifying description of the building.
- G. Waiver of special inspection. The requirement for employment of a registered special inspector may be waived if the Building Official finds that the construction is of minor nature.

CHAPTER 18.08 CERTIFICATE OF OCCUPANCY

18.08.010 – Certificate required for use or occupancy.

18.08.020 – Issuance of certificates.

18.08.030 – Contents of certificate.

18.08.040 – Temporary certificate.

18.08.050 – Posting.

18.08.060 – Revocation.

CHAPTER 18.08 CERTIFICATE OF OCCUPANCY

18.08.010 – Certificate required for use or occupancy.

In order to safeguard life and limb, health, property and public welfare, no building or structure shall be used or occupied, and no change in the existing use or occupancy classification of a building or structure or portion thereof shall be made until the Building Official has issued a Certificate of Occupancy therefore as provided in this chapter.

EXCEPTIONS:

1. Unless it is specifically required by the Building Official or other provisions of this title, municipal code or other ordinances of the City or laws and statutes of the State, no existing building or portion thereof shall require a Certificate of Occupancy, provided:
 - a. The occupancy and use housed therein is the same for which the original building permit was issued and a final inspection approved,
 - b. Alteration or repair are minor in nature and does not affect fire life-safety or structural stability of a building or portion thereof as determined by the Building Official, and
 - c. The occupancy or use of a building or portion thereof housing a Group A or E occupancy and has not been discontinued for a period of more than six (6) months.
2. No structure, the architecture of which inhibits occupancy, shall require a Certificate of Occupancy.
3. Certificate of Occupancy are not required for work not in scope of this title under Section 18.01.040 or work exempt from permits under Section 18.04.020.

Issuance of a Certificate of Occupancy shall not be construed as an approval of a violation of the provisions of this title, municipal code or other ordinances of the City or laws and statutes of the State. Certificates presuming to give authority to violate or cancel the provisions of this title, municipal code or other ordinances of the City or laws and statutes of the State shall not be valid.

18.08.020 – Issuance of certificates.

When required by Section 18.08.010, after the Building Official inspects the building or structure and finds no violations of the provisions of this title, municipal code or other ordinances of the City or laws and statutes of the State that are enforced by the Building Official or other departments or agencies within the City, and after other applicable City departments or agencies as determined by the Building Official have reported that all required public improvements have been completed, the Building Official shall issue a Certificate of Occupancy that contains the information specified in Section 18.08.030.

When a Certificate of Occupancy is issued, it shall supersede every certificate previously issued for that portion of the building or structure or portion thereof described thereon.

18.08.030 – Contents of certificate.

Each certificate shall contain the following:

1. The building permit number.
2. The address of the building.

3. The name and address of the owner.
4. A description of that portion of the building for which the certificate is issued.
5. A statement that the described portion of the building has been inspected for compliance with the requirements of this title for group and division of occupancy and the use for which the proposed occupancy is classified.
6. The name of the Building Official.
7. The edition of the code under which the permit was issued.
8. The use and occupancy, in accordance with the provisions of Chapter 3 of the California Building Code adopted in Chapter 18.40.
9. The type of construction as defined in Chapter 6 of the California Building Code adopted in Chapter 18.40.
10. The design occupant load.
11. If an automatic sprinkler system is provided, whether the sprinkler system is required.
12. Any special stipulations and conditions of the building permit.
13. The signature of the Building Official.

18.08.040 - Temporary certificate.

Notwithstanding the provisions of Section 18.08.020, if the Building Official finds that no substantial hazard will result from the occupancy of any building, or portion thereof, before the same is completed, and satisfactory evidence is submitted that the work could not have been completed prior to the time such occupancy is desired because of its magnitude or because of unusual construction difficulties, and where other applicable City departments or agencies as determined by the Building Official have reported that all required public improvements have been completed, the Building Official may issue a Temporary Certificate of Occupancy for any building or portion thereof.

The Building Official may issue a Temporary Certificate of Occupancy notwithstanding the fact that all required public improvements have not been completed, if the Building Official finds that the failure to complete the public improvements was due to circumstances over which the person applying for the Certificate of Occupancy had no control.

In addition, the Building Official may issue a Temporary Certificate of Occupancy for an existing building, or portion thereof, provided no substantial hazard will result and satisfactory evidence is submitted justifying the need for such temporary occupancy.

Permit applicants for a Temporary Certificate of Occupancy shall pay an investigation fee as set forth in Section 18.06.180 for which approval of temporary occupancy is sought, including extending a Temporary Certificate of Occupancy beyond thirty (30) day or for each additional thirty (30) day period or fraction thereof.

18.08.050 - Posting.

The Certificate of Occupancy shall be posted in a conspicuous place on the premises and shall not be removed except by the Building Official.

EXCEPTION: One- or two-family dwelling and related accessory building and structure.

18.08.060 - Revocation.

The Building Official may, in writing, suspend or revoke a Certificate of Occupancy or Temporary Certificate of Occupancy issued under the provisions of this title whenever the certificate is issued in error, or on the basis of incorrect information supplied, or when it is determined that the occupancy or the maintenance of any building or structure, or any portion thereof, continues contrary to or in violation of any provisions of this title, municipal code or other ordinances of the City or laws and statutes of the State, and such continued occupancy or maintenance will result in the exposure of occupants and/or people in the vicinity to hazardous, dangerous or unsafe conditions. Such suspension or revocation shall be immediate but shall be subject to appeal in accordance with the provisions of Chapter 18.10.

CHAPTER 18.09 VIOLATIONS

18.09.010 – General.

18.09.020 – Notice of violation.

18.09.030 – Prosecution of violation.

18.09.040 – Violation penalties.

18.09.050 – Violation for obtaining permit without owner's consent.

18.09.060 – Making false statement.

18.09.070 – Unpermitted structures.

18.09.080 – Validity of approval.

CHAPTER 18.09 VIOLATIONS

18.09.010 – General.

It shall be unlawful for any person, firm or corporation to:

1. Erect, construct, alter, extend, repair, move, remove, demolish or occupy any building, structure or equipment in the City regulated by this title, or cause same to be done, in conflict with or in violation of any of the provisions of this title, municipal code or other ordinances of the City or laws and statutes of the State. Maintenance of any building, structure or equipment that was unlawful at the time it was erected, constructed, altered, extended, repaired, moved, removed, demolished or occupied and which would be unlawful under this title if completed after the effective date of this title shall constitute a continuing violation of this title.
2. Grade, excavate or fill any land in the City regulated by this title, or cause same to be done, in conflict with or in violation of any of the provisions of this title, municipal code or other ordinances of the City or laws and statutes of the State.
3. Install, alter, repair, replace, add to, relocate, use or maintain electrical systems, equipments, appliances, fixtures, fittings and appurtenances thereto in the City, or cause or permit the same to be done, contrary to or in violation of any of the provisions of this title, municipal code or other ordinances of the City or laws and statutes of the State. Maintenance of electrical installation that was unlawful at the time it was installed and which would be unlawful under this title if installed after the effective date of this title shall constitute a continuing violation of this title.
4. Use or maintain any plumbing, gas piping or water piping or to use, occupy or maintain any building, structure or premises containing any plumbing, gas piping or water piping in the City, or cause or permit the same to be done, contrary to or in violation of any of the provisions of this title, municipal code or other ordinances of the City or laws and statutes of the State. Maintenance of plumbing or plumbing installation that was unlawful at the time it was installed and which would be unlawful under this title if installed after the effective date of this title shall constitute a continuing violation of this title.
5. Erect, install, alter, repair, relocate, add to, replace, use, or maintain heating, ventilating, cooling, or refrigeration equipment in the City, or cause or permit the same to be done, contrary to or in violation of any of the provisions of this title, municipal code or other ordinances of the City or laws and statutes of the State. Maintenance of mechanical equipment that was unlawful at the time it was installed and which would be unlawful under this title if installed after the effective date of this title shall constitute a continuing violation of this title.

The permissive provisions of this title shall not be presumed to waive any limitations imposed by any of the provisions of this title, municipal code or other ordinances of the City or laws and statutes of the State.

18.09.020 – Notice of violation.

Pursuant to Section 18.03.020, the Building Official is authorized to serve a notice of violation or order on the person, firm or corporation responsible for the erection, construction, alteration, extension, repair, moving, removal, demolition or occupancy of a building or structure in violation of the provisions of this title, municipal code or other ordinances of the City or laws and statutes of the State; or in violation of a permit or certificate issued under the provisions of this title, municipal code or other ordinances of the City or laws and statutes of the State. Such notice or order shall direct the discontinuance of the illegal action or condition and the abatement of the violation.

18.09.030 – Prosecution of violation.

If the notice of violation or order is not complied with promptly or within the time limit specified therein, the Building Official is authorized to request the legal Council of the City to institute the appropriate proceeding at law or in equity to restrain, correct or abate such violation, or to require the removal or termination of the unlawful occupancy of the building or structure in violation of the provisions of this title, municipal code or other ordinances of the City or laws and statutes of the State or of the order or direction made pursuant thereto.

18.09.040 – Violation penalties.

Any person, firm or corporation who violates the provisions of this title, municipal code or other ordinances of the City or laws and statutes of the State or fails to comply with any of the requirements thereof or who erects, constructs, alters or repairs a building or structure in violation of the approved construction documents or directive of the Building Official, or of a permit or certificate issued under the provisions of this title, shall be subject to penalties as prescribed by law.

18.09.050 – Violation for obtaining permit without owner's consent.

Every person, firm or corporation who knowingly and willfully procures a permit without the consent of the owner of record of the property for which the permit is issued, or such person's, firm's or corporation's agent, may be guilty of a misdemeanor as determined by the legal council of the City.

EXCEPTION: This section shall not apply to permits obtained pursuant to and in compliance with an order of a court of law or a governmental agency.

18.09.060 – Making false statement.

Any person, firm or corporation who willfully or knowingly, with the intent to deceive, makes a false statement or representation, or knowingly fails to disclose a material fact in any documentation required by the Building Official to ascertain facts relative to this title, including any oral or written evidence presented, may be guilty of a misdemeanor as determine by the legal Council of the City. The Building Official may, in writing, suspend or revoke a permit issued under provisions of this title whenever the permit is issued in error or on the basis of incorrect, inaccurate or incomplete information supplied, or in violation of any provisions of this title, municipal code or other ordinances of the City or laws and statutes of the State.

For the purposes of this section, a "person" includes any person who is a registered special inspector, a structural inspector, a certified welder or a certified licensed contractor. The term "writing" shall include, but is not limited to, forms, applications, approvals, reports or certifications required by the Building Official. Every violation of this title may be punishable as a misdemeanor as determine by the legal council of the City.

18.09.070 – Unpermitted structures.

No person, firm or corporation shall own, use, occupy or maintain any "unpermitted structure." For the purpose of this title, "unpermitted structure" shall be defined as any structure, or portion thereof, that was erected, constructed, enlarged, altered, repaired, remodeled, moved, removed, improved, converted or demolished at any point in time, without the required permit(s) having first been obtained from the Building Official, pursuant to Section 18.04.010.

18.09.080 – Validity of approval.

- A. Approval not a violation of title. Approval as a result of a plan examination or an inspection shall not be construed to be an approval of a violation of the provisions of this title, municipal code or other ordinances of the City or laws and statutes of the State applicable thereto. Plan examinations or inspections presuming to give authority to violate or cancel the provisions of this title, municipal code or other ordinances of the City or laws and statutes of the State applicable thereto shall not be valid. No approval shall relieve or exonerate any person from the

responsibility of complying with the provisions and intent of this title, municipal code or other ordinances of the City or laws and statutes of the State.

- B. Correction of errors. The issuance of a permit based upon approved construction documents shall not prevent the Building Official from thereafter requiring the correction of errors on the construction documents or from preventing construction being carried on thereunder when in violation of the provisions of this title, municipal code or other ordinances of the City or laws and statutes of the State.

CHAPTER 18.10 BOARD OF APPEALS

- 18.10.010 – General regulations.
- 18.10.020 – Board of Examiners, Appeals and Condemnation.
- 18.10.030 – Disabled Access Appeals Board.
- 18.10.040 – Advisory capacity.
- 18.10.050 – Limitation of authority.
- 18.10.060 – Compensation.

CHAPTER 18.10 BOARD OF APPEALS

18.10.010 – General regulations.

The provisions of Chapter 2.18 provide uniform general regulations applicable to all Boards for the performance of various prescribed duties and functions. In the event any provision of Chapter 2.18 conflicts with a specific provision of this title, such specific provision of this title shall control.

18.10.020 – Board of Examiners, Appeals and Condemnation.

- A. General. In order to determine the suitability of alternate materials and types of construction and to provide for reasonable interpretations of the provisions of this title, municipal code or other ordinances of the City or laws and statutes of the State, and in order to provide a forum to review the determinations of the Building Official relative thereto as well as to make determinations relative to correction of substandard conditions in buildings and to abate nuisances, there is created a Board of Examiners, Appeals and Condemnation established pursuant to Ordinance No. C-5332 in 1977 and amended pursuant to Ordinance No. C-5709 in 1981.
- B. Member. The Board of Examiners, Appeals and Condemnation shall consist of seven (7) members qualified by experience and training to pass judgment upon matters pertaining to building construction; they shall be recommended by the City Manager for appointment by the Mayor and confirmation by the City Council. Members shall serve two (2) year terms and shall be eligible for reappointment if their service does not exceed the eight (8) year maximum established by City Council. The Building Official shall serve as Secretary to the Board.
- C. Duties. The Board of Examiners, Appeals and Condemnation shall conduct hearings on written appeals regarding any action taken by the Building Official in enforcing the provisions of this title, municipal code or other ordinances of the City or laws and statutes of the State. In the appeal, the Board of Examiners, Appeals and Condemnation may approve or disapprove interpretations of these regulations and enforcement actions taken by the Building Official.
- D. Procedure. The Board of Examiners, Appeals and Condemnation shall adopt reasonable rules and regulations for conducting its investigations and hearings and where not specifically provided otherwise by such rules, Robert's Rules of Order shall govern. All decisions and findings of the Board of Examiners, Appeals and Condemnation shall be in writing and shall be filed with the Secretary with copies to the interested parties. Four (4) members shall constitute a quorum for transaction of business; and each member, including the member serving as Chairman, shall be entitled to vote on any matter coming before the Board of Examiners, Appeals and Condemnation. All decisions shall be entered upon the minutes of the meetings of the Board, and the Building Official shall be guided in accordance therewith. All decisions of the Board of Examiners, Appeals and Condemnation shall be final and conclusive in the absence of fraud or prejudicial abuse of discretion.
- E. Filing requirement. Any person aggrieved by any ruling of the Building Official interpreting the provisions of this title, municipal code or other ordinances of the City or laws and statutes of the State or requiring the doing of any remedial work, or with respect to such person's application for approval of a substitute material or type of construction may appeal to the Board of Examiners, Appeals and Condemnation within thirty (30) days from the date of such ruling or order by serving a written notice upon the Secretary of the Board. A written notice shall be submitted together with a fee as set forth in Section 18.06.100. Such written notice shall state that the applicant is dissatisfied with a ruling or order of the Building Official and shall describe the nature of the complaint. Such appellant shall pay the cost of all tests made or ordered by the Board of Examiners, Appeals and Condemnation. Such notice shall be at once transmitted to the Board of Examiners, Appeals and Condemnation, and the Board of Examiners, Appeals and Condemnation shall thereafter fix a time and place for a hearing, at which time all persons

interested in the appeal shall be heard. The Secretary shall give the appellant at least ten (10) days notice of hearing.

18.10.030 – Disabled Access Appeals Board.

- A. General. Pursuant to Section 19957.5 of the California Health and Safety Code, there is hereby created a board to be known as the Disabled Access Appeals Board established pursuant to City Council Resolution No. C-23275 in 1981 and amended pursuant to Ordinance No. C-7183 in 1994 to hear written appeals regarding action taken by the Building Official in its enforcement of State regulations pertaining to access to public accommodations by physically handicapped persons.
- B. Members. The Disabled Access Appeals Board shall consist of five (5) members. Two (2) members of the Disabled Access Appeals Board shall be physically handicapped persons, two (2) members shall be persons experienced in construction and one (1) member shall be a public member. The City Manager shall recommend members for appointment by the Mayor and confirmation by the City Council. Members shall serve two (2) year terms and shall be eligible for reappointment if their service does not exceed the eight (8) year maximum established by the City Council. The Building Official shall serve as Secretary to the Disabled Access Appeals Board.
- C. Duties. The Disabled Access Appeals Board shall conduct hearings on written appeals regarding any action taken by the Building Official in enforcing the provisions of State law pertaining to access to public accommodations by physically handicapped persons, including any exceptions contained in Section 19957 of the California Health and Safety Code. In the appeal, the Disabled Access Appeals Board may approve or disapprove interpretations of these regulations and enforcement actions taken by the Building Official.
- D. Procedures. The Disabled Access Appeals Board shall adopt reasonable rules and regulations for conducting the hearings and shall appoint one (1) member to preside as chairman; and where not specifically provided otherwise by such rules, Robert's Rules of Order shall govern. All decisions and findings of the Disabled Access Appeals Board shall be in writing and shall be filed with the Secretary with copies to the interested parties. Three (3) members shall constitute a quorum for transaction of business; and each member, including the member serving as Chairman, shall be entitled to vote on any matter coming before the Board. All decisions shall be entered upon the minutes of the meetings of the Board, and the Building Official shall be guided in accordance therewith. All decisions of the Board shall be final and conclusive in the absence of fraud or prejudicial abuse of discretion.
- E. Filing requirement. Any person may file a written notice of appeal with the Secretary of the Board within thirty (30) days after an action is taken by the Building Official regarding the regulations pertaining to public access for handicapped persons. A written notice shall be submitted together with a fee as set forth in Section 18.06.100. Such written notice shall state that the applicant is dissatisfied with a ruling or order of the Building Official and shall describe the nature of the complaint. Thereafter, the Disabled Access Appeals Board shall set a time and place for hearing the appeal and all persons interested shall be heard. The Secretary shall give the appellant at least ten (10) days notice of hearing.

18.10.040 – Advisory capacity.

Each Board, upon request of the Building Official, may be called together in an advisory capacity in order to assist the Building Official.

18.10.050 – Limitations on authority.

An application for appeal shall be based on a claim that the true intent of the provisions of this title, municipal code or other ordinances of the City or laws and statutes of the State or the rules legally adopted thereunder has been incorrectly interpreted, the provisions of this title, municipal code or other ordinances of the City or laws and statutes of the State do not fully apply or an equally good or better form of construction is proposed. Each Board shall have no authority to waive the provisions of

this title, municipal code or other ordinances of the City or laws and statutes of the State or the rules legally adopted thereunder.

18.10.060 – Compensation.

Each member of all Boards shall be paid by the City, as compensation for his or her services, such sum as may, from time to time, be provided by ordinance. Such compensation shall in no way void a member's eligibility for obtaining any City work in the course of his or her private practice or business.

CHAPTER 18.17 TRANSPORTATION IMPROVEMENT FEE

- 18.17.010 – Short title.
- 18.17.020 – Purpose.
- 18.17.030 – Affected area—Designation of subareas.
- 18.17.040 – Definitions.
- 18.17.050 – Transportation Improvement Fee requirements—Imposition—Collection.
- 18.17.055 – Transportation Demand Management Measure requirements.
- 18.17.060 – Amount of Transportation Improvement Fee.
- 18.17.070 – Calculation of Transportation Improvement Fee.
- 18.17.080 – Collection of Transportation Improvement Fee.
- 18.17.090 – Establishment of Transportation Improvement Fee account.
- 18.17.100 – Limitation on use of funds derived from Transportation Improvement Fees.
- 18.17.110 – Credits.
- 18.17.120 – Refunds.
- 18.17.130 – Exemptions.
- 18.17.140 – Accounting and audits.
- 18.17.150 – Appeals.
- 18.17.160 – Judicial review.
- 18.17.170 – Annual report and amendment procedures.
- 18.17.180 – Effect of Transportation Improvement Fee on zoning and subdivision regulations.
- 18.17.190 – Transportation Improvement Fee as additional and supplemental requirement.

CHAPTER 18.17 TRANSPORTATION IMPROVEMENT FEE

18.17.010 – Short title.

This chapter shall be known and cited as the Long Beach Transportation Improvement Fee Ordinance or as the Transportation Fee Ordinance. The fees imposed pursuant to this chapter shall be known as "Transportation Improvement Fees."

18.17.020 – Purpose.

A Transportation Improvement Fee is imposed on new development in the City for the purpose of assuring that the transportation level of service goals of the City as set forth in the traffic mitigation program are met with respect to the additional demands placed on the transportation system by traffic generated from such development.

18.17.030 – Affected area—Designation of subareas.

- A. This chapter shall be applicable to all new development in the City including the planned development central business district (CBD) area of the City, except as otherwise provided herein.
- B. In the CBD area of the City, Transportation Improvement Fees shall be imposed on all commercial development, including, but not limited to, office, retail, hotel and movie theaters, as set forth in the fee setting resolution adopted by the City Council pursuant to this chapter.
- C. Citywide, Transportation Improvement Fees shall be imposed on all residential development and on all industrial development as set forth in the fee setting resolution adopted by the City Council pursuant to this chapter.
- D. Citywide, but excluding the CBD area of the City, Transportation Improvement Fees shall be imposed on all commercial development including, but not limited to, office, retail, hotel and movie theaters, as set forth in the fee setting resolution adopted by the City Council pursuant to this chapter.

18.17.040 – Definitions.

For purposes of this chapter, the words and terms defined herein shall have the meanings stated, unless another meaning is plainly intended. To the extent that terms utilized in this chapter are not defined herein, but are defined in Title 21 of this code, such terms shall have the meanings stated therein.

- A. "Accessory use" is as defined in Section 21.15.060 of this code.
- B. "Applicant" means the owner of property, or owner's authorized agent for which a request for development approval is received by the City.
- C. "Building permit" means the City permit required for new building construction and/or additions which add square footage pursuant to this title. Neither a grading permit nor a foundation permit shall be considered a building permit for purposes of this chapter.
- D. "Calculation" means the point in time at which the City calculates the Transportation Improvement Fee to be paid by the applicant. Calculation will generally occur at the time of issuance of a Certificate of Occupancy, but may occur earlier in the development approval process.
- E. "Central business district" area or planned development central business district (CBD) area means the area of the City as delineated on Exhibit 1, attached to the ordinance codified in this

chapter and incorporated herein by reference, and which is coterminous with the planned development CBD area as defined in the City of Long Beach general plan land use element.

- F. "Certificate of Occupancy" means the official City certification, issued pursuant to Section 18.08.020 et seq. of this code, that all or a portion of the building, structure or addition is suitable for use or occupancy. For purposes of this chapter, Certificate of Occupancy shall refer to the earlier of, issuance of a Certificate of Occupancy for the building shell or issuance of a Certificate of Occupancy for use or occupancy of all or a portion of the building by a tenant, owner or occupant.
- G. "City-wide" means the entire area of the City including the CBD area, as delineated on Exhibit 1, attached to the ordinance codified in this chapter and incorporated herein by reference.
- H. "Collection" means the point in time at which the Transportation Improvement Fees are paid by the applicant. Collection will generally occur at and as a condition precedent to issuance of the Certificate of Occupancy.
- I. "Commitment" means the earmarking of Transportation Improvement Fees collected to fund or partially fund or to retire debt issued for the funding of transportation improvements serving new residential and nonresidential development.
- J. "Demand" means the portion of transportation capacity that new development will consume measured in PM peak hour trips.
- K. "Development" means the addition of new dwelling units and/or new nonresidential square footage to an undeveloped, partially developed or redeveloped site and involving the issuance of a building permit or Certificate of Occupancy for such construction, reconstruction or use, but not including the following so long as no additional dwelling units or gross floor area is added: (i) a permit to operate, (ii) a permit for the internal alteration, remodeling, rehabilitation, or other improvements or modifications to an existing structure, (iii) the rebuilding of a structure destroyed by an act of God or the rehabilitation or replacement of a building in order to comply with the City seismic safety requirements, (iv) parking facilities, or (v) the rehabilitation or replacement of a building destroyed by imminent public hazard, acts of terrorism, sabotage, vandalism, warfare or civil disturbance except where said destruction was caused or in any manner accomplished, instigated, motivated, prompted, incited, induced, influenced, or participated in by any persons or their agents having any interest in the real or personal property at the location.
- L. "Development approval" means tentative map approval, parcel map approval, or site plan approval if the imposition of the Transportation Improvement Fee could lawfully have been imposed at such time or, building permit issuance if the Transportation Improvement Fee could not be lawfully imposed at tentative map, parcel map or site plan approval or Certificate of Occupancy issuance if the Transportation Improvement Fee could not be lawfully imposed at building permit issuance.
- M. "Dwelling unit" or "DU" is as defined in Section 21.15.910 of this code.
- N. "Fee-setting resolution" means and refers to the City resolution specifying the Transportation Improvement Fee per dwelling unit for residential development and per gross square foot of floor area for nonresidential development, by type and by location.

The Transportation Improvement Fees set forth in the fee-setting resolution may be revised pursuant to Section 18.17.060 and applicable State law.
- O. "Gross square feet" or "gsf" means the area of a nonresidential development measured from the exterior building lines of each floor with respect to enclosed spaces but excluding parking spaces whether or not enclosed.

- P. "Highway capacity manual" means and refers to the report entitled Highway Capacity Manual, Special Report 209 (Transportation Research Board, 1985) or as thereafter amended.
- Q. "Imposition" means the determination that the Transportation Improvement Fee is applicable to the development and the attachment of the Transportation Improvement Fee as a specific condition of development approval.
- R. "ITE trip generation manual" means and refers to the informational report entitled "Trip Generation" by the Institute of Transportation Engineers, Fourth Edition, 1987, or as thereafter amended.
- S. "Level of service" (LOS) means an indicator of the extent or degree of service provided by, or proposed to be provided by, a transportation improvement based upon the relationship of traffic volume to road capacity and related to the operational characteristics of the road as measured by standards set forth in the highway capacity manual.
- T. "Long Beach transportation study (1989)" means the study performed for the City by Barton-Aschman Associates, Inc., and including Volume I-Traffic, Volume II-Parking, Volume III-Transit, and the Report on the Allocation of Transportation Improvement Costs, which collectively form the basis for travel demand forecasts and transportation improvement plans and recommendations.
- U. "Mixed use" is as defined in Section 21.15.1760 of this code.
- V. "Nonresidential development" means a development undertaken for the purpose of creating gross floor area, excluding dwelling units, but which includes but is not limited to commercial, industrial, retail, office, hotel/motel, and warehouse uses involving the issuance of a building permit or Certificate of Occupancy for such construction, reconstruction or use.
- W. "Parking facility" means the construction of an improvement, whether enclosed or unenclosed, providing parking spaces for vehicles and which may include but is not limited to the installation of ancillary facilities such as sidewalks, drainage improvement, lighting, landscaping, striping, exits and entrances, signage, waiting areas and other project-related improvements.
- X. "PM peak hour" means a one-hour period of time between 4:00 p.m. and 6:00 p.m., when the development generates the maximum number of trips.
- Y. "PM peak hour trips" means the total number of trips generated by a development during the p.m. peak hour.
- Z. "Principal use" is as defined in Section 21.15.2170 of this code.
- AA. "Residential development" means a development undertaken for the purpose of creating a new dwelling unit or units and involving the issuance of a building permit or Certificate of Occupancy for such construction, reconstruction or use.
- BB. "Road facility" means the construction of a road link or intersection which expands capacity to accommodate additional traffic, and which may include but is not limited to the installation of ancillary facilities such as sidewalks, curbs, gutters, traffic signals, traffic signs, lighting, landscaping, striping, medians, turn lanes and other project-related improvements.
- CC. "Traffic mitigation program of Long Beach" or "traffic mitigation program" means and refers to the City's long range strategic and financing plan for transportation improvements as adopted by resolution of the City Council.
- DD. "Transit facility" means the purchase of buses and/or the construction of an improvement ancillary to the operation of the Long Beach bus system and, which may include but is not limited to, the

installation of facilities such as bus shelters, bus turn lanes, lighting, landscaping, signage, and other project-related improvements.

EE. "Transportation improvement" means and refers to a project identified in the transportation improvement plan and involving the construction of a road facility or portion thereof, the construction of parking facilities, the construction of transit improvements, including the purchase of buses, the construction of other project-related improvements, including, but not limited to, right-of-way and land acquisition, utility relocation, project planning, administrative, legal, engineering, and design services and project contingencies.

FF. "Transportation Improvement Fee" means a monetary exaction imposed as a condition of development approval in order to assure the provision of transportation improvements needed to serve new development within a reasonable period of time at City level of service goals as set forth in the traffic mitigation program.

GG. "Transportation improvement plan" means the identification, listing, cost and prioritization of transportation improvements necessary to meet travel demand forecasts through the year 2010 while maintaining the City's level of service for transportation, as set forth in the traffic mitigation program.

HH. "Transportation services" means and refers to nonphysical, programmatic efforts to reduce traffic including, but not limited to, transportation demand management.

II. "Accessory residential use" is as defined in Section 21.15.063. An accessory residential unit which exceeds two hundred twenty (220) square feet of residential dwelling space shall be classified as a single-family dwelling unit for purposes of application of the Transportation Improvement Fee.

JJ. "Secondary housing unit" is as defined and regulated in Sections 21.15.2400 and 21.51.275. A secondary housing unit which exceeds six hundred forty (640) square feet of residential dwelling space shall be classified as a standard dwelling unit for purposes of application of the Transportation Improvement Fee.

KK. "Senior citizen housing" is as defined in Section 21.15.2430 of this code. The applicant shall be required to guarantee the units shall be maintained for senior citizen housing whether rented, leased, sold, conveyed or otherwise transferred, for the lesser of a period of thirty (30) years or the actual life or existence of the structure, including any addition, renovation or remodeling thereto. The guarantee shall be in the form of a deed restriction or other legally binding and enforceable document acceptable to the City. The document shall be recorded with the Los Angeles County Recorder prior to the issuance of a Certificate of Occupancy. The applicant shall comply with the maintenance of the units for senior citizen housing according to the City's Housing and Community Improvement Bureau procedures. The Housing and Community Improvement Bureau shall establish a process for monitoring any applicant for any successor-in-interest shall be required to provide annually, or as requested, proof of compliance.

LL. "Transportation demand management measures" means a program designed to reduce p.m. peak hour existing work trips from a proposed development site by a minimum of twenty percent (20%).

18.17.050 – Transportation Improvement Fee requirements—Imposition—Collection.

A. All development shall be required to pay a Transportation Improvement Fee at the time of issuance of a Certificate of Occupancy, except as otherwise provided in Subsection 18.17.050.G or Section 18.17.130. The City may, prior to the issuance of a building permit for a development subject to the Transportation Improvement Fee, require that the applicant, or lessee if the lessee's interest appears of record, as a condition of issuance of the building permit, execute a

contract with the City to pay the applicable Transportation Improvement Fee at the time of issuance of the Certificate of Occupancy.

- B. Transportation Improvement Fees shall be imposed at the time of tentative map approval, parcel map approval, site plan approval, building permit issuance or Certificate of Occupancy issuance. The City shall impose the condition of payment of Transportation Improvement Fees at the earliest point in time as such fees could have been lawfully imposed.
- C. Transportation Improvement Fees shall be collected no later than at the time of issuance of a Certificate of Occupancy, except as otherwise provided in Subsection 18.17.050.G.
- D. Whenever a development contains more than one (1) building, the Transportation Improvement Fee shall be paid in a lump sum for all dwelling units or gross floor area in each building of the development for which a Certificate of Occupancy is sought.
- E. Imposition of the Transportation Improvement Fee requirement shall be a condition of development approval, and no tentative map, parcel map or site plan shall be approved nor shall a building permit or Certificate of Occupancy be issued without compliance with the provisions of this chapter.
- F. The Transportation Improvement Fee requirement shall not apply to applicants who have a valid Certificate of Occupancy on the effective date of the ordinance codified in this chapter.
- G. For developments exceeding one hundred thousand (100,000) gross square feet which have not received a Certificate of Occupancy prior to October 1, 1996, the applicant shall pay the Transportation Improvement Fee either (1) in full at issuance of the Certificate of Occupancy or (2) in four installments as set forth herein.

The first payment shall equal twenty-five percent (25%) of the total transportation fee owed and shall be payable at the time of the issuance of the Certificate of Occupancy. The balance of the Transportation Improvement Fee shall accrue interest at a rate equal to that earned on the City's pooled investment funds (which rate shall be published annually by the City Treasurer), and shall be paid in three (3) annual installments, commencing upon the first anniversary of the issuance of the Certificate of Occupancy for the development. The balance of the transportation fee may be prepaid by the applicant at any time. In the event that the applicant (or applicant's successor-in-interest) fails to pay any installment when due, the Certificate of Occupancy issued for the development may be revoked at the option of the City.

Payments pursuant to the installment option and the rights and obligations of the applicant and the City shall be set forth in a contract which shall be executed at and as a condition precedent to issuance of a Certificate of Occupancy. Applicant shall post a bond, certificate of deposit, letter of credit or other instrument acceptable to the City Attorney in an amount equal to the Transportation Improvement Fee calculated to be due and payable by installment at the time of execution of the contract. The City Council authorizes the City Manager to execute such contracts on behalf of the City.

18.17.055 – Transportation demand management measure requirements.

Transportation demand management measure requirements, where applicable, in addition to Transportation Improvement Fees shall be implemented in conjunction with Chapter 21.64.

18.17.060 – Amount of Transportation Improvement Fee.

- A. The Transportation Improvement Fee per p.m. peak hour trip by land use type and, where relevant, by location shall be established by fee-setting resolution of the City Council and may be amended from time to time as set forth in Section 18.17.170.

- B. The Transportation Improvement Fee imposed pursuant to this chapter shall not apply to applicants who have a valid building permit on the effective date of the ordinance codified in this section. Applicants who have a valid building permit on the effective date of the ordinance codified in this section and who are not otherwise exempted, shall continue to be subject to the Transportation Improvement Fee imposed pursuant to Ordinance C-6836.

18.17.070 – Calculation of Transportation Improvement Fee.

- A. The Director shall calculate the amount of the applicable Transportation Improvement Fee due at the time of and as a condition precedent to issuance of the Certificate of Occupancy based upon the applicable impact fee rate as specified in the then current fee-setting resolution.
- B. The Director shall calculate the amount of the applicable Transportation Improvement Fee due by:
 - 1. Determining the number and type of dwelling units in a residential development, and multiplying the same by the Transportation Improvement Fee amount per dwelling unit;
 - 2. Determining the gross square feet of floor area, type of use and location in a nonresidential development, and multiplying the same by the Transportation Improvement Fee amount as established by the fee-setting resolution;
 - 3. Determining the number and type of dwelling units and the nonresidential number of gross square feet of floor area, type of use and location in a structure containing mixed uses which include a residential use, and multiplying the same by the Transportation Improvement Fee amount for each use as established by the fee-setting resolution;
 - 4. Determining the gross square feet of floor area, type of use and location in a structure containing mixed uses which include two (2) or more nonresidential principal uses, and multiplying the same by the Transportation Improvement Fee amount as established by the fee-setting resolution. The gross square feet of floor area of any accessory use will be charged at the same rate as the predominant principal use unless the Director finds that the accessory use is related to another principal use.
- C. The Director shall be responsible for determining the use type of the proposed development. If the Director determines that the proposed development is not in one of the use classifications included in the fee-setting resolution or, if the applicant submits relevant information and documentation acceptable to the Director demonstrating that the proposed development is not in one of the use classifications included in the fee-setting resolution or is a mixed use, the Director of Public Works shall:
 - 1. Determine whether the proposed development has trip generation characteristics similar to a listed use classification;
 - 2. If so, that use classification shall be used in calculating the appropriate Transportation Improvement Fee;
 - 3. If not, identify the trip generation characteristics of the proposed development and, utilizing the ITE trip generation manual, assign the proposed use to the most similar land use type listed in the manual;
 - 4. If there are no similar land use types listed in the ITE trip generation manual, the applicant may be requested to perform, at his or her own expense, a trip generation study or may utilize other statistically valid trip generation data applicable to the proposed use.

18.17.080 – Collection of Transportation Improvement Fee.

The Director shall be responsible for the collection of the Transportation Improvement Fee at and as a condition precedent to the issuance of a Certificate of Occupancy unless:

- A. The applicant is entitled to a full credit pursuant to Section 18.17.110; or
- B. The applicant is exempt pursuant to Section 18.17.130; or
- C. The applicant has taken an appeal pursuant to Section 18.17.150 and a cash deposit, letter of credit, bond or other surety in the amount of the Transportation Improvement Fee, as calculated by the Director, has been posted with the City;
- D. The applicant satisfies the conditions for Transportation Improvement Fee payment by installments pursuant to Subsection 18.17.050.G.

18.17.090 – Establishment of Transportation Improvement Fee account.

The City establishes a segregated Transportation Improvement Fee subfund (hereinafter "subfund") to which all Transportation Improvement Fees collected by the Director shall be deposited. The funds of the subfund shall not be commingled with any other funds or revenues of the City except for purposes of investment; but, provided that all such funds shall be separately accounted for. The subfund shall be interest-bearing and all interest received shall be credited to such subfund and used solely for purposes of the subfund.

18.17.100 – Limitation on use of funds derived from Transportation Improvement Fees.

- A. Funds derived from payment of Transportation Improvement Fees pursuant to this chapter shall be placed in the subfund and shall be used solely and exclusively for the purpose of funding transportation improvements, as defined herein, and as identified in the transportation improvement plan or to reimburse the City for expenditures, advances or indebtedness incurred for the construction of transportation improvements.
- B. Transportation Improvement Fees shall not be used for the provision of roadway, parking or transit improvements relating to (i) the needs of existing City residents, (ii) the enhancement of transportation improvements to provide a higher level of service to existing development, (iii) operation and maintenance costs associated with roadway, parking or transit improvements, (iv) repair and/or replacement of existing roadway, parking and transit improvements or (v) the provision of transportation services, as contrasted with transportation improvements.
- C. The City shall commit or expend Transportation Improvement Fees deposited to the subfund within five (5) years from the date of deposit. The City shall make findings once each fiscal year with respect to any Transportation Improvement Fees remaining unexpended or uncommitted in the subfund five (5) or more years after the deposit of the fee to identify the purpose to which the fee is to be put and to demonstrate a reasonable relationship between the fee and the purpose for which it was charged.

18.17.110 – Credits.

- A. Any applicant subject to a Transportation Improvement Fee pursuant to this chapter who constructs, escrows money with the City for the construction of, participates in an assessment district for the construction of or who otherwise contributes funds or improvements to the City for transportation improvements, as herein defined, shall be eligible for a credit for such contribution against the Transportation Improvement Fee otherwise due.
- B. Credit applications shall be made on forms provided by the City and, whenever possible, shall be submitted at or before the time of building permit issuance. The application shall contain a declaration of those facts, under oath, along with relevant documentary evidence which qualifies the applicant for the credit.

- C. The Director of Public Works shall determine whether the proposed construction, escrow payment, assessment district or cash contribution is for a transportation improvement listed in the transportation improvements plan or for a comparable transportation improvement, and is consistent with the project priorities and timing and, if necessary, shall determine the value of the developer contribution.
- D. The Director of Public Works shall forward his report and the credit application and supporting documentary evidence to the City Council, for a determination of Transportation Improvement Fee credit. If the City Council determines that a Transportation Improvement Fee credit is due, said decision shall be confirmed by ordinance and shall be incorporated in a contract between the applicant and the City except as otherwise provided herein.
- E. No credit shall be granted in an amount exceeding the otherwise applicable Transportation Improvement Fee.
- F. Notwithstanding Subsections 18.17.110.A through 18.17.110.D, if an applicant's property is in the airport traffic study area and the applicant has paid Airport Area Traffic Fees or assessments pursuant to Section 18.19.030 et seq. of this code, the applicant shall be entitled to a credit in the amount of the Airport Area Traffic Fees paid or the portion of the present value of the total assessment district payment to be used for transportation improvements which the applicant is obligated to pay, without the necessity for a determination by the City Council, the enactment of an ordinance or the execution of a contract between the applicant and the City.
- G. Notwithstanding Subsections 18.17.110.A through 18.17.110.D, if an applicant's property is in the CBD area, and the applicant has obtained a building permit prior to the effective date of the ordinance codified in this chapter but has not yet received a Certificate of Occupancy, and is subject to an assessment district to mitigate traffic impacts, the applicant shall be entitled to a credit for the full amount of Transportation Improvement Fee otherwise due, without the necessity for a determination by the City Council, the enactment of an ordinance or the execution of a contract between the applicant and the City.
- H. Credits shall be on a building-by-building basis as development approval is sought and not on a development site basis.

18.17.120 – Refunds.

- A. Any applicant who has paid a Transportation Improvement Fee pursuant to this chapter may apply for a full or partial refund of same, if, within one (1) year after collection of the Transportation Improvement Fee (i) the development has been modified, pursuant to appropriate City ordinances and regulations, resulting in a reduction in the number of dwelling units in a residential project or in a mixed use development including residential uses, and/or the gross floor area of development in a nonresidential or mixed use development or (ii) a change in the type of use occurs which results in a reduction of trips generated by the ultimate use.
- B. Refund applications shall be made on forms provided by the City and shall contain a declaration of those facts, under oath, along with relevant documentary evidence which qualifies the applicant for the refund. In no event may a refund exceed the amount of the Transportation Improvement Fee paid by the applicant.
- C. Except as described in Subsection 18.17.120.E, upon application by the property owner the City shall refund the portions of the Transportation Improvement Fee which have been on deposit over five (5) years and which are unexpended or uncommitted. Refunds shall be made to the then current record owner or owners of lots or units of the development on a prorated basis, together with accrued interest.

- D. Once each fiscal year the City shall make findings identifying all unexpended or uncommitted Transportation Improvement Fees in the subfund.
- E. With respect to Transportation Improvement Fees unexpended or uncommitted five (5) years after deposit in the subfund, the City may make findings to identify the purpose to which the Transportation Improvement Fee is to be put and to demonstrate a reasonable relationship between the Transportation Improvement Fee and the purpose for which it was charged. If the City makes such findings, the Transportation Improvement Fees are exempt from the refund requirement. The findings need only be made with respect to funds in the possession of the City and need not be made with respect to letters of credit, bonds or other instruments taken to secure payment of Transportation Improvement Fees at a future date.
- F. The City shall refund the unexpended or uncommitted portion of Transportation Improvement Fees by direct payment, by providing a temporary suspension of Transportation Improvement Fees for subsequent development projects of developers entitled to the refund, or by any other means consistent with the intent of this section. The determination by the City Council of the means by which revenues are to be refunded is a legislative act.
- G. If the City finds that the administrative costs of refunding the unexpended or uncommitted Transportation Improvement Fees exceed the amount to be refunded, the City, after a public hearing, notice of which has been published in accordance with State law and posted in three (3) prominent places within the area of each development subject to a refund, may determine that the funds shall be allocated for other transportation improvements of the type for which the Transportation Improvement Fees were collected and which serve the development.

18.17.130 – Exemptions.

The following uses and types of development are exempt from the payment of Transportation Improvement Fees.

- A. Nonresidential development: Construction or occupancy of a new nonresidential building or structure or an addition to or expansion of an existing nonresidential building or structure of three thousand (3,000) gross square feet or less, or serving a use which generates ten (10) or fewer PM peak hour trips pursuant to the ITE Trip Generation Manual.
- B. Residential development.
 - 1. Construction, replacement or rebuilding of a single-family dwelling (one unit per lot) on an existing lot of record, or the replacement of one (1) mobile home with another on the same pad, or the moving and relocation of a single-family home from one (1) lot within the City to another lot within the City, or the legalization of an illegal dwelling unit existing prior to January 1, 1964, for which an administrative use permit is approved in accordance with Subsection 21.25.403.D. This exemption shall not apply to tract development nor to the development of more than one (1) unit per lot nor to the replacement of a single-family dwelling with more than one (1) dwelling unit.
 - 2. Affordable housing for lower income households.

Property rented, leased, sold, conveyed or otherwise transferred, at a rental price or purchase price which does not exceed the "affordable housing cost" as defined in Section 50052.5 of the California Health and Safety Code when provided to a "lower income household" as defined in Section 50079.5 of the California Health and Safety Code or "very low income household" as defined in Section 50105 of the California Health and Safety Code. This exemption shall require the applicant to execute an agreement to guarantee the units shall be maintained for lower and very low income households whether as units for rent or for sale or transfer, for the lesser of a period of thirty years or the actual life or existence of the structure, including any addition, renovation or remodeling thereto. The agreement shall be in

the form of a deed restriction, second trust deed, or other legally binding and enforceable document acceptable to the City Attorney and shall bind the owner and any successor-in-interest to the real property being developed. The agreement shall subordinate, if required, to any State or Federal program providing affordable housing to lower and very low income households. The agreement shall be recorded with the Los Angeles County Recorder prior to the issuance of a Certificate of Occupancy. The City's Housing and Community Improvement Bureau shall be notified of pending transfers or purchases and give its approval of the purchaser's qualifying income status and purchase price, prior to the close of escrow. The City's Housing and Community Improvement Bureau shall be notified of pending rentals and give its approval of proposed tenant's qualifying income status and rental rate, prior to the tenant's occupancy. Applicant or any successor-in-interest shall be required to provide annually, or as requested, the names of all tenants or purchasers, current rents, and income certification to insure compliance. Voluntary removal of the housing restriction or violation of the restriction shall be enforced by the Director and shall require the applicant or any successor-in-interest to pay the then applicable Transportation Improvement Fee at the time of voluntary conversion or as imposed at the time of violation on the unit in violation, plus any attorneys' fees and costs of enforcement if applicable.

18.17.140 – Accounting and audits.

- A. For each subfund established pursuant to Section 18.17.090, the City shall, within sixty (60) days of the close of each fiscal year, make available to the public the beginning and ending balance for the fiscal year, and the Transportation Improvement Fees, interest and other income and the amount of expenditures by public facility and the amount of refunds made during the fiscal year. The City Council shall review this information at the next regularly scheduled public meeting not less than fifteen (15) days after the availability of the information required hereby.
- B. Any applicant may request an audit of the Transportation Improvement Fee in order to determine whether the fee exceeds the amount reasonably necessary to provide the transportation improvements to serve new development at the level of service set forth in the traffic mitigation program. Upon such request for an audit, the City Council may request the City auditor to conduct an audit to determine whether the Transportation Improvement Fee is reasonable. Any costs incurred by the City in having an audit conducted may be recovered from the applicant who requests the audit.

18.17.150 – Appeals.

- A. An applicant may validly appeal, by protest, any imposition of the Transportation Improvement Fee by filing a notice of appeal with the City Clerk at the time of development approval or conditional development approval or within ninety (90) days after the date of imposition of the Transportation Improvement Fee upon the development.
- B. A valid appeal by protest of the imposition of the Transportation Improvement Fee shall meet both of the following requirements:
 - 1. Tendering any required payment in full or providing satisfactory assurance of payment;
 - 2. Serving written notice on the City including:
 - a. A statement that the required payment has been tendered under protest or that required conditions have been satisfied,
 - b. A statement informing the City of the factual elements of the dispute and the legal theory forming the basis of the protest;
 - c. The name and address of the applicant,

- d. The name and address of the property owner,
 - e. A description and location of the property,
 - f. The number of residential units or nonresidential gross square footage proposed, by land use or dwelling unit type, as appropriate,
 - g. The date of imposition of the Transportation Improvement Fee upon the development.
- C. The City Council shall schedule a hearing and render a final decision on the applicant's appeal within one hundred sixty (160) days after the date of the imposition of the Transportation Improvement Fee upon the development.
- D. The City Council hearing shall be administrative. Evidence shall be submitted by the City and by the applicant and testimony shall be taken under oath.
- E. The burden of proof shall be on the applicant to establish that the applicant is not subject to imposition of the Transportation Improvement Fee pursuant to the express terms of this chapter and applicable State law.
- F. If the Transportation Improvement Fee has been paid in full or if the notice of appeal is accompanied by a cash deposit, letter of credit, bond or other surety acceptable to the City Attorney in an amount equal to the Transportation Improvement Fee calculated to be due, the application for development approval shall be processed. The filing of a notice of appeal shall not stay the imposition or the collection of the Transportation Improvement Fee calculated by the City to be due unless sufficient and acceptable surety has been provided.
- G. If as a result of an appeal pursuant to this section or judicial review pursuant to Section 18.17.160, a Transportation Improvement Fee is reduced or waived, the City Council may determine whether and how such reduction or waiver may impact the Transportation Improvement Fee calculation methodology. If the City Council determines that transportation improvement needs are correspondingly reduced, the City Council may amend the Transportation Improvement Fee calculation methodology, the applicable Transportation Improvement Fee, or take such other action as it may deem appropriate. If the City Council determines that transportation improvement needs remain the same, the City Council shall appropriate funds in an amount equal to the reduction or waiver of Transportation Improvement Fees and shall deposit same to the subfund or take such other action as it may deem appropriate.
- H. Any petition for judicial review of the City Council's final decision shall be made in accordance with applicable State law and pursuant to Section 18.17.160.

18.17.160 – Judicial review.

- A. Any judicial action or proceeding to attack, review, set aside, void or annul the ordinance codified in this chapter, or any provision thereof, or resolution, or amendment thereto, shall be commenced within one hundred twenty (120) days of the effective date of the ordinance codified in this chapter, resolution, or any amendment thereto.
- B. Any judicial action or proceeding to attack, review, set aside or annul the imposition or collection of a Transportation Improvement Fee on a development shall be preceded by a valid appeal by protest pursuant to Section 18.17.150 hereof and a final decision of the City Council pursuant thereto and shall be filed and service of process effected within one hundred eighty (180) days after the date of the imposition of the Transportation Improvement Fee upon the development.

18.17.170 – Annual report and amendment procedures.

- A. At least once each year the Director of Public Works shall evaluate progress in implementation of the transportation improvement plan and the Transportation Improvement Fee and shall prepare a report thereon to the City Council incorporating:
1. The total amount of development granted development approval in the City by type;
 2. The estimated increase in PM peak hour trips generated by approved development;
 3. The transportation improvements completed relative to the improvements listed in the transportation improvement plan;
 4. The amount of Transportation Improvement Fees in the subfund; and
 5. Recommended changes to the Transportation Improvement Fee, including but not necessarily limited to, changes in the transportation improvement plan and changes in the Transportation Improvement Fees chapter or fee-setting resolution.
- B. Based upon the report and such other factors as the City Council deems relevant and applicable, the City Council may amend the ordinance codified in this chapter or the fee-setting resolution implementing this chapter. Changes to Transportation Improvement Fee rates or schedules may be made by amending the fee-setting resolution. Any change which increases the amount of the Transportation Improvement Fee shall be adopted by the City Council only after a noticed public hearing. Nothing herein precludes the City Council or limits its discretion to amend the ordinance codified in this chapter, the Long Beach Transportation Study (1989), the traffic mitigation program, the transportation improvement plan, or the fee-setting resolution establishing Transportation Improvement Fee rates or schedules at such other times as may be deemed necessary.

18.17.180 – Effect of Transportation Improvement Fee on zoning and subdivision regulations.

This chapter shall not affect, in any manner, the permissible use of property, density/intensity of development, design and improvement standards and public improvement requirements or any other aspect of the development of land or construction of buildings, which may be imposed by the City pursuant to the zoning ordinance, subdivision regulations or other ordinances or regulations of the City, which shall be operative and remain in full force and effect without limitation with respect to all residential and nonresidential development.

18.17.190 - Transportation Improvement Fee as additional and supplemental requirement.

The Transportation Improvement Fee imposed by this chapter is a fee imposed on residential and nonresidential development reflecting its proportionate share of the cost of providing transportation improvements necessary to meet the demand created by such development at City level of service goals as set forth in the traffic mitigation program. As such, the Transportation Improvement Fee is additional and supplemental to, and not in substitution of, either on-site transportation improvement requirements or off-site transportation improvement requirements necessary to provide access to the development, which may be imposed by the City pursuant to zoning, subdivision and other City ordinances and regulations. In no event shall an applicant for development approval be obligated to pay a Transportation Improvement Fee in excess of that calculated pursuant to this chapter.

CHAPTER 18.18 PARK AND RECREATION FACILITIES FEE

- 18.18.010 – Short title.
- 18.18.020 – Purpose.
- 18.18.030 – Definitions.
- 18.18.040 – Requirement.
- 18.18.050 – Amount of Park Fee.
- 18.18.060 – Calculation of applicable Park Fee.
- 18.18.070 – Collection of Park Fee.
- 18.18.080 – Establishment of Park Fee account.
- 18.18.090 – Limitation on use of funds derived from Park Fees.
- 18.18.100 – Credits.
- 18.18.110 – Refunds.
- 18.18.120 – Exemptions.
- 18.18.130 – Audits.
- 18.18.140 – Appeals.
- 18.18.150 – Judicial review.
- 18.18.160 – Amendment procedures.
- 18.18.170 – Effect of Park Fee on zoning and subdivision regulations.
- 18.18.180 – Park Fee as additional and supplemental requirement.

CHAPTER 18.18 PARK AND RECREATION FACILITIES FEE

18.18.010 – Short title.

This chapter shall be known and cited as the "Long Beach Park and Recreation Facilities Impact Fee Ordinance." The fees imposed pursuant to this chapter shall be known as "Park Fees."

18.18.020 – Purpose.

A Park Fee is hereby imposed on new residential development for the purpose of assuring that the park land and recreational facility standards established by the City are met with respect to the additional needs created by such development.

18.18.030 – Definitions.

For purposes of this chapter, the following words and terms shall have the meanings stated herein, unless another meaning is plainly intended:

- A. "Accessory residential unit" is a dwelling unit as identified in Section 21.15.063 of this code. An accessory residential unit which exceeds two hundred twenty (220) square feet of residential dwelling space shall be classified as a single-family, duplex or multifamily dwelling unit for purposes of application of the Park Fee.
- B. "Applicant" means the property owner, or duly designated agent of the property owner, of land on which a request for development approval is received by the City.
- C. "Building permit" means the City permit required for new building construction and/or additions which add a dwelling unit, pursuant to Title 18 of the municipal code.
- D. "Certificate of Occupancy" means the official certification that a premises conforms to the provisions of the zoning regulations and Building Code and may be used or occupied.
- E. "Collection" means the point at which the Park Fee due is calculated by the City and collected from the applicant.
- F. "Commitment" means the earmarking of Park Fees collected to fund or partially fund or to retire debt issued for the funding of park land acquisition or recreation improvements serving new residential development.
- G. "Development approval" means tentative map or parcel map approval if the imposition of the Park Fee could lawfully have been imposed at such time or, building permit issuance if Park Fees could not be lawfully imposed at tentative map or parcel map approval.
- H. "Dwelling unit" or "DU" is as defined in Section 21.15.910 of this code.
- I. "Duplex" means a building containing two dwelling units.
- J. "Imposition" means the determination that the Park Fee is applicable to the residential development project and the attachment of the Park Fee requirement as a specific condition of development approval.
- K. "Mobile home" is as defined in Section 21.15.1770 of this code.
- L. "Multifamily" means a permanent building designed for or occupied by three (3) or more families living independently of each other. This includes apartment houses and condominiums, but does not include hotels, motels, communal housing, residential care facilities or convalescent hospitals.

- M. "Park Fee" means a monetary exaction imposed as a condition of development approval in connection with a residential development project in order to fund and to assure the provision of park land and recreation improvements needed to serve such development at established City service level standards within a reasonable period of time.
- N. "Park land" means land used or to be used or acquired or to be acquired for use as a City park or open space or property owned by another public entity, such as a public school site, which is improved by the City and designated to meet City park land and recreation improvement needs related to projected residential development.
- O. "Recreation improvement" means the construction of facilities, including, but not limited to, soccer fields, softball fields, lighting, landscaping, bicycle paths, tennis courts, indoor recreational space and related facilities, the expenditure of funds for such facilities and improvements incidental thereto, and the expenditure of funds for the planning, design and engineering of such facilities and improvements and utility relocation ancillary thereto and designed to meet City park land and recreation improvement needs related to projected residential development.
- P. "Residential development project" means any residential development undertaken for the purpose of creating a new dwelling unit or units and involving the issuance of a building permit for such construction, reconstruction or use, but not including the following so long as no additional dwelling units are added: (i) a permit to operate, (ii) a permit issued for the internal alteration, remodeling, rehabilitation or other improvements to an existing structure, (iii) the rebuilding of a structure destroyed by an act of God, (iv) the rehabilitation or replacement of a building in order to comply with the City seismic safety requirements, or (v) the rehabilitation or replacement of a building destroyed by imminent public hazard, acts of terrorism, sabotage, vandalism, warfare or civil disturbance except where said destruction was caused or in any manner accomplished, instigated, motivated, prompted, incited, induced, influenced or participated in by any persons or their agents having any interest in the real or personal property at the location.
- Q. "Secondary housing unit" is as defined and regulated in Sections 21.15.2400 and 21.51.275 of this code. A secondary housing unit which exceeds six hundred forty (640) square feet of residential dwelling space shall be classified as a single-family, duplex or multifamily dwelling unit for purposes of application of the Park Fee.
- R. "Single-family dwelling" means a residential unit designed and intended for occupancy by one (1) family as defined in Section 21.15.2410 of this code.

18.18.040 – Requirement.

- A. All residential development shall be required to pay a Park Fee prior to the issuance of a Certificate of Occupancy. The City may, prior to the issuance of a building permit for a residential development subject to the Park Fee, require that the applicant, as a condition of issuance of the building permit execute a contract with the City to pay the applicable Park Fee prior to issuance of the Certificate of Occupancy.
- B. Park Fees shall be imposed, where possible, at the time of tentative map approval, parcel map approval or site plan approval of a residential development.
- C. Park Fees shall be collected prior to the issuance of a Certificate of Occupancy for a residential development.
- D. Whenever a residential development project contains more than one (1) dwelling unit, the Park Fee shall be paid in a lump sum for all dwelling units in each phase of a residential development project for which a Certificate of Occupancy is sought.

- E. Payment of the Park Fee due shall be a condition of development approval of all residential development projects, and no tentative map or parcel map or site plan shall be approved nor shall a building permit be issued without compliance with the provisions of this chapter.
- F. The Park Fee requirement shall not apply to applicants who have a valid building permit on the effective date of the ordinance codified in this chapter.

18.18.050 – Amount of Park Fee.

- A. The Park Fee per dwelling unit, by type, shall be established by resolution of the City Council and may be amended from time to time as set forth in Section 18.18.160.
- B. The Park Fee imposed pursuant to this chapter shall not apply to applicants who have a valid building permit on the effective date of the ordinance codified in this section. Applicants who have a valid building permit on the effective date of the ordinance codified in this section and who are not otherwise exempt, shall continue to be subject to the Park Fee imposed pursuant to Ordinance C-6567.
- C. The fees established by this chapter shall be revised annually by means of an automatic adjustment based on the average percentage change over the previous calendar year in the Construction Cost Index for the Los Angeles metropolitan area. The first fee adjustment shall not be made before October 1, 2008. The fees, as adjusted annually, shall be compiled by the Department of Parks, Recreation and Marine, and shall be included in an annual report to the City Council pertaining to the Park Fee. The annual report shall be presented to the City Council by August 1st of each year, and fee adjustments shall be effective on October 1st of each year. The continued validity of the fee calculation methodology and the automatic adjustment shall be evaluated by a Nexus Study which shall be presented to the City Council for its consideration and action every five (5) years, commencing with the annual report due on or before August 1, 2012.

18.18.060 – Calculation of applicable Park Fee.

Upon receipt of an application for a Certificate of Occupancy, the Director shall calculate the amount of the applicable Park Fee due by determining the number and type of dwelling units in the proposed residential development project and multiplying same by the Park Fee amount per dwelling unit, by type, as established by City Council resolution.

18.18.070 - Collection of Park Fee.

The Director shall be responsible for the collection of the Park Fee prior to the issuance of a Certificate of Occupancy unless:

- A. The applicant is entitled to a full credit pursuant to Section 18.18.100 of this chapter; or
- B. The applicant is exempt pursuant to Section 18.18.120 of this chapter; or
- C. The applicant has taken an appeal pursuant to Section 18.18.140 of this chapter and a bond or other surety in the amount of the fee, as calculated by the Director, has been posted with the City.

18.18.080 – Establishment of Park Fee account.

The City hereby establishes a segregated Park Fee trust fund account (hereinafter "account") to which all Park Fees collected by the Director shall be posted. The funds of the account shall not be commingled with any other funds or revenues of the City and all such funds shall be accounted for. The account shall be an interest bearing account and all interest received shall be credited to such account and used solely for purposes of the account.

18.18.090 – Limitation on use of funds derived from Park Fees.

- A. Funds derived from payment of Park Fees pursuant to this chapter shall be placed in the account and shall be used solely and exclusively for the purpose of funding park land acquisition and recreation improvements, as defined herein, and as identified in the Park Fee report, or to reimburse the City for expenditures, advances or indebtedness incurred for the acquisition of park land or construction of recreation improvements, as defined herein or identified in the Park Fee report. Park Fees shall not be used for the provision of park land or recreation improvements, as defined herein, and as identified in the Park Fee report, or to reimburse the City for expenditures, advances or indebtedness incurred for the acquisition of park land or construction of recreation improvements, as defined herein or identified in the Park Fee report. Park Fees shall not be used for the provision of park land or recreation improvements relating to (i) the needs of existing City residents, (ii) the enhancement of park and recreation facilities to provide a higher level of service to existing City residents, (iii) operation and maintenance costs associated with City park and recreation facilities, (iv) repair and/or replacement of existing park and recreational facilities, or (v) the provisions of recreational services and programming.
- B. The City shall commit or expend Park Fees deposited to the account within five (5) years from the date of deposit.

18.18.100 – Credits.

- A. Any applicant subject to a Park Fee pursuant to this chapter who constructs, escrows money with the City for the construction of, agrees to participate in an assessment district for the construction of or who otherwise contributes funds or improvements to the City for the acquisition of park land or the construction of recreation improvements as herein defined, may be eligible for a credit for such contribution against the Park Fee otherwise due.
- B. Credit applications shall be made on forms provided by the City and, whenever possible, shall be submitted at or before the time of building permit issuance. The application shall contain a declaration of those facts, under oath, along with relevant documentary evidence which qualifies the applicant for the credit.
- C. The Director of Parks, Recreation and Marine shall determine whether the proposed construction, escrow payment, assessment district or cash contribution is for a recreation improvement listed in the Park Fee report and is consistent with the project priorities and timing and, if necessary, shall determine the value of the developer contribution.
- D. The Director of Parks, Recreation and Marine shall forward his report and the credit application and supporting documentary evidence to the City Council, for a determination of Park Fee credit. If the City Council determines that a Park Fee credit is due, said decision shall be confirmed by ordinance and shall be incorporated in a contract between the applicant and the City.
- E. No credit shall be granted in an amount exceeding the otherwise applicable Park Fee.

18.18.110 – Refunds.

- A. Any applicant who has paid a Park Fee pursuant to this chapter may apply for a full or partial refund of same, if, within one (1) year after collection of the Park Fee the residential development project has been modified, pursuant to appropriate City ordinances and regulations, resulting in a reduction in the number of dwelling units, a change in the type of dwelling units or the applicability of an exemption pursuant to Section 18.18.120 of this chapter. Refund applications shall be made on forms provided by the City and shall contain a declaration of those facts, under oath, along with relevant documentary evidence which qualifies the applicant for the refund. In no event may a refund exceed the amount of the Park Fee actually paid.
- B. Once each fiscal year the City shall make findings identifying all unexpended or uncommitted fees in the account.

- C. Except as described in Subsection 18.18.110.D, upon application of the property owner the City shall refund the portions of any impact fee which have been on deposit over five (5) years and which are unexpended or uncommitted. Refunds shall be made to the then current record owner or owners of the development project or projects on a prorated basis, together with accrued interest.
- D. With respect to fees unexpended or uncommitted within five (5) years of deposit in the Park Fee account, the City may make findings to identify the purpose to which the fee is to be put and to demonstrate a reasonable relationship between the fee and the purpose for which it was charged. If the City makes such findings, the fees are exempt from the refund requirement.
- E. The City may refund the unexpended or uncommitted portion of Park Fees by direct payment, by offsetting such refunds against other Park Fees due for residential development projects on the subject property, or by other means subject to agreement by the property owner.
- F. If the City finds that the administrative costs of refunding the unexpended or uncommitted Park Fees exceeds the amount to be refunded, the City, after a public hearing, notice of which has been published in accordance with State law and posted in three (3) prominent places within the area of each residential development project subject to a refund, may determine that the funds shall be allocated for other park land acquisition or recreation improvement projects of the type for which the Park Fees were collected and which serve the residential development project.

18.18.120 - Exemptions.

The following uses and types of residential development are exempt from the payment of Park Fees:

- A. The following actions shall be exempt from the fee:
 - 1. Replacement of existing dwelling units. If the applicant is proposing to replace an existing legal dwelling unit or units with a greater number of units on the same lot, then the fee will be paid only for the number of new dwelling units that exceed the number of the existing legal dwelling units on that lot. A dwelling unit shall be considered existing if it is a legal dwelling unit as defined in Section 21.15.910 of this code (or any successor section thereto) and it existed on the lot within twelve (12) months prior to the application for a building permit for the replacement unit or units;
 - 2. The placement or installation of a replacement mobilehome as defined in Section 21.15.1770 of this code (or any successor section thereto) on a separate lot, mobilehome park space or pad when a park and recreation facilities fee for such lot or space has been previously paid pursuant to this chapter; or when a mobilehome legally existed on such park space or pad within twelve (12) months prior to construction approval for the replacement mobilehome;
 - 3. The relocation of existing legal dwelling units from one location in the City to another;
 - 4. The legalization of an existing illegal dwelling unit existing prior to January 1, 1964, for which an administrative use permit is approved in accordance with Subsection 21.25.403.D (or any successor section thereto).
- B. Affordable housing for lower income households. Property rented, leased, sold, conveyed or otherwise transferred, at a rental price or purchase price which does not exceed the "affordable housing cost" as defined in Section 50052.5 of the California Health and Safety Code when provided to a "lower income household" as defined in Section 50079.5 of the California Health and Safety Code or "very low income household" as defined in Section 50105 of the California Health and Safety Code. This exemption shall require the applicant to execute an agreement to guarantee the units shall be maintained for lower and very low income households whether as units for rent or for sale or transfer, for the lesser of a period of thirty (30) years or the actual life

or existence of the structure, including any addition, renovation or remodeling thereto. The agreement shall be in the form of a deed restriction, second trust deed, or other legally binding and enforceable document acceptable to the City Attorney and shall bind the owner and any successor-in-interest to the real property being developed. The agreement shall subordinate, if required, to any State or Federal program providing affordable housing to lower and very low income households. The agreement shall be recorded with the Los Angeles County Recorder prior to the issuance of a Certificate of Occupancy. The City's Housing and Community Improvement Bureau shall be notified of pending transfers or purchases and give its approval of the purchaser's qualifying income status and purchase price, prior to the close of escrow. The City's Housing and Community Improvement Bureau shall be notified of pending rentals and give its approval of proposed tenant's qualifying income status and rental rate, prior to the tenant's occupancy. Applicant or any successor-in-interest shall be required to provide annually, or as requested, the names of all tenants or purchasers, current rents, and income certification to insure compliance. Voluntary removal of the housing restriction or violation of the restriction shall be enforced by the Director and shall require the applicant or any successor-in-interest to pay the then applicable Park Fee at the time of voluntary conversion or as imposed at the time of violation on the unit in violation, plus any attorneys' fees and costs of enforcement if applicable.

18.18.130 – Audits.

Any person may request an audit of the Park Fee in order to determine whether the Park Fee exceeds the amount reasonably necessary to provide the park land acquisition and recreation improvements to serve new residential development at the City's established service level standards. Upon such request for an audit, the City Council may retain an independent auditor to conduct an audit to determine whether the Park Fee is reasonable. Any costs incurred by the City in having the audit conducted by an independent auditor may be recovered from the person who requests the audit.

18.18.140 – Appeals.

- A. An applicant may validly appeal, by protest, any imposition of the Park Fee by filing a notice of appeal with the City Clerk at the time of development approval or conditional development approval or within ninety (90) days after the date of the imposition of the Park Fee upon the development.
- B. A valid appeal by protest of the imposition of the Park Fee shall meet both of the following requirements:
 1. Tendering any required payment in full or providing satisfactory assurance of payment;
 2. Serving written notice on the City including:
 - a. A statement that the required payment has been tendered under protest or that required conditions have been satisfied,
 - b. A statement informing the City of the factual elements of the dispute and the legal theory forming the basis of the protest,
 - c. The name and address of the applicant,
 - d. The name and address of the property owner,
 - e. A description and location of the property,
 - f. The number of residential units or nonresidential square footage proposed, by land use or dwelling unit type, as appropriate,

- g. The date of imposition of the Park Fee upon the development.
- C. The City Council shall schedule a hearing and render a final decision on the applicant's appeal within one hundred sixty (160) days after the date of the imposition of the Park Fee upon the development.
- D. The City Council hearing shall be administrative. Evidence shall be submitted by the City and by the applicant and testimony shall be taken under oath.
- E. The burden of proof shall be on the applicant to establish that the applicant is not subject to imposition of the Park Fee pursuant to the express terms of this chapter and applicable State law.
- F. If the Park Fee has been paid in full or if the notice of appeal is accompanied by a cash deposit, letter of credit, bond or other surety acceptable to the City Attorney in an amount equal to the Park Fee calculated to be due, the application for development approval shall be processed. The filing of a notice of appeal shall not stay the imposition or the collection of the Park Fee calculated by the City to be due unless sufficient and acceptable surety has been provided.
- G. If as a result of an appeal pursuant to this section or judicial review pursuant to Section 18.18.150, a Park Fee is reduced or waived, the City Council may determine whether and how such reduction or waiver may impact the Park Fee calculation methodology. If the City Council determines that park and recreation needs are correspondingly reduced, the City Council may amend the Park Fee calculation methodology, the applicable Park Fee, or take such other action as it may deem appropriate. If the City Council determines that park and recreation needs remain the same, the City Council shall appropriate funds in an amount equal to the reduction or waiver of Park Fees and shall deposit same to the subfund or take such other action as it may deem appropriate.
- H. Any petition for judicial review of the City Council's final decision shall be made in accordance with applicable State law and pursuant to Section 18.18.150.

18.18.150 – Judicial review.

- A. Any judicial action or proceeding to attack, review, set aside, void or annul the ordinance codified in this chapter, or any provision thereof, or amendment thereto, shall be commenced within one hundred twenty (120) days of the effective date of the ordinance codified in this chapter, resolution, or any amendment thereto.
- B. Any judicial action or proceeding to attack, review, set aside or annul the imposition or collection of a Park Fee on a development shall be preceded by a valid appeal by protest pursuant to Section 18.18.140 hereof and a final decision of the City Council pursuant thereto and shall be filed and service of process effected within one hundred eighty (180) days after the date of imposition upon the development.

18.18.160 – Amendment procedures.

At least once every year after the first year that this chapter has been effective, prior to City Council adoption of the annual budget and capital improvements program, staff shall prepare a report to the City Council on the subject of impact fees and shall incorporate:

- A. Recommendations on amendments, if appropriate, to this chapter or to resolutions establishing impact fee amounts.
- B. Proposed changes to the Park Fee report identifying capital improvements to be funded by impact fees.
- C. Proposed changes in the impact fee calculation methodology or variables pertaining thereto.

- D. Proposed changes to impact fee rates or schedules. Based upon the report and such other factors as the City Council deems relevant and applicable, the City Council may amend this chapter and resolutions establishing impact fee rates or schedules. Changes to the impact fee rates or schedules may be made by resolution. Any change which increases the amount of the fee shall be adopted by the City Council after a noticed public hearing. Nothing herein precludes the City Council or limits its discretion to amend this chapter, the Park Fee report or resolutions establishing impact fee rates or schedules at such other times as may be deemed necessary.

18.18.170 – Effect of Park Fee on zoning and subdivision regulations.

This chapter shall not affect, in any manner, the permissible use of property, density of development, design and improvement standards and public improvement requirements or any other aspect of the development of land or construction of buildings, which may be imposed by the City pursuant to the zoning ordinance, subdivision regulations or other ordinances or regulations of the City, which shall be operative and remain in full force and effect without limitation with respect to all such residential development projects.

18.18.180 – Park Fee as additional and supplemental requirement.

The Park Fee imposed by this chapter is a fee imposed on residential development projects reflecting its proportionate share of the cost of providing park land and improvements necessary to meet the needs created by such development at established City service level standards. As such, the Park Fee is additional and supplemental to, and not in substitution of, on-site open space requirements imposed by the City pursuant to zoning, subdivision and other City ordinances and requirements. In no event shall an applicant for development approval be obligated to pay a Park Fee in excess of that calculated pursuant to this chapter, which shall not individually or collectively exceed the reasonable cost of providing park land and recreation improvements to such residential development project at established City service level standards.

CHAPTER 18.20 UNSAFE BUILDINGS OR STRUCTURES

- 18.20.010 – Substandard buildings—Proceedings for repair.
- 18.20.020 – Substandard buildings—Notice required.
- 18.20.030 – Substandard buildings—Service of notice.
- 18.20.040 – Substandard buildings—Order to vacate.
- 18.20.050 – Substandard buildings—Vacating and reoccupying.
- 18.20.060 – Substandard buildings—Posting of placard on vacated building.
- 18.20.070 – Nonconforming buildings—Notice to comply or vacate.
- 18.20.080 – Dangerous buildings or conditions—Correction proceedings.
- 18.20.090 – Dangerous buildings or conditions—Inspection.
- 18.20.100 – Dangerous buildings or conditions—Abatement proceedings.
- 18.20.110 – Dangerous buildings or conditions—Summary abatement.
- 18.20.120 – Inspection of buildings—Report.
- 18.20.130 – Hearing by Board of Examiners, Appeals and Condemnation.
- 18.20.140 – Appeals to City Council.
- 18.20.150 – Demolition or repairs by City—Expense liability.
- 18.20.160 – Service of notices and orders.
- 18.20.170 – Extensions of time to perform work.
- 18.20.180 – Owner's responsibility for enforcement costs.
- 18.20.190 – Abatement charges.
- 18.20.200 – Hearing on charges.
- 18.20.210 – Interest on charges.
- 18.20.220 – Transfer of collection.
- 18.20.230 – Method of collection.
- 18.20.240 – Tax-sold property.
- 18.20.250 – Tax-sold property—Redemptions.
- 18.20.260 – Error correction—Assessment cancellation.
- 18.20.270 – Refunds.
- 18.20.280 – Notice to secure structure.
- 18.20.290 – Emergency hazard abatement.
- 18.20.300 – Criminal prosecution.

CHAPTER 18.20 UNSAFE BUILDINGS OR STRUCTURES

18.20.010 – Substandard buildings—Proceedings for repair.

Whenever the Building Official determines by inspection that an existing building is substandard, or constitutes a nuisance, he or she shall institute proceedings to cause the repair, rehabilitation, vacation or demolition of such building.

18.20.020 – Substandard buildings—Notice required.

The Building Official shall give notice specifying the inadequacies and hazards to be corrected. Such notice shall also specify that the building may be ordered vacated if remedial measures are not commenced and completed within the time specified in the notice which time shall be such as the Building Official concludes is reasonable in view of the circumstances, but which shall in no event require commencement of such work within less than thirty (30) days nor completion within less than ninety (90) days.

18.20.030 – Substandard buildings—Service of notice.

Notices shall be given by service thereof in the manner elsewhere provided in this chapter for service of notices. Service of such notice in the manner therein prescribed shall constitute notice to the owner of such building, and failure of any such person to receive such notice shall in no manner affect the validity of the subsequent proceedings taken hereunder. In addition to giving such notice, the Building Official shall also prepare and cause to be recorded with the county recorder, a certificate stating that the building described is a substandard building, or is a public nuisance, and that the owner thereof has been so notified. When, and if, all required corrections to such a building have been made, the Building Official shall cause the certificate of substandard buildings or public nuisance to be terminated and cause to be recorded with the County Recorder a copy thereof.

18.20.040 – Substandard buildings—Order to vacate.

If, after thirty (30) days from service of the notice requiring remedial work, as provided in Section 18.20.030, such work is not commenced, or within ninety (90) days of such notice, such work is not completed, the Building Official may order the building vacated and posted as specified in Section 18.20.060. If the building is unoccupied, the order to vacate may be immediate. If the building is occupied, a notice of intent to order the building vacated shall be given thirty (30) days prior to issuing such order.

18.20.050 – Substandard buildings—Vacating and reoccupying.

Any substandard buildings, ordered vacated in accordance with Sections 18.20.010 through 18.20.060, shall be immediately vacated and shall not be reoccupied until the inadequacies or hazards specified by the Building Official in his notice as provided in Sections 18.20.010 through 18.20.060 have been eliminated and approval obtained from the Building Official for reinstatement of the occupancy. No person shall occupy or cause to be occupied any building or portion thereof which has been ordered vacated until approval of such occupancy is reinstated by the Building Official.

18.20.060 – Substandard buildings—Posting of placard on vacated building.

- A. Each such building ordered vacated shall be locked and otherwise secured against ingress, and the Department of Development Services shall post thereon a placard stating:

SUBSTANDARD BUILDING

Do Not Occupy
By Order of

Department of Development Services
City of Long Beach

This building has been ordered vacated and it is a misdemeanor to occupy this building. It is a misdemeanor to remove this placard. Sections 18.20.010 through 18.20.060 of the Long Beach Municipal Code.

- B. Notice of such posting and a copy of the posted notice shall be served on the owner by certified mail at the time of posting. No person other than a representative of the Department shall remove such a placard from any building where it has been officially posted. Each such building shall be rehabilitated within two (2) months after being ordered vacated or it shall be removed or demolished. If this rehabilitation, removal or demolition has not been accomplished within the above mentioned two-month period, then the Building Official shall institute action to correct violations or to demolish.

18.20.070 – Nonconforming buildings—Notice to comply or vacate.

Whenever any building or portion thereof is being maintained, occupied or used contrary to the provisions of this title or municipal code, the Building Official shall order such unlawful use, occupancy or maintenance to be discontinued by a date certain. If the maintenance, occupancy or use of any such building or portion thereof is not made to comply with the requirements of this title within the time set forth in the aforesaid order, the Building Official may order that the building, or the portion thereof in which any such violation occurs, be vacated. Such vacation shall be immediate but shall be subject to appeal in accordance with the provisions of this chapter. No person shall use or occupy such building or portion of building so vacated until such unlawful use, occupancy or maintenance has been discontinued and approval obtained from the Building Official for reinstatement of the occupancy.

18.20.080 – Dangerous buildings or conditions—Correction proceedings.

Whenever the Building Official determines by inspection that any building or structure, or portion thereof, is dangerous as defined in Section 18.02.050, he or she shall institute proceedings to correct such dangerous conditions.

18.20.090 – Dangerous buildings or conditions—Inspection.

- A. The Building Official and a duly authorized representative and the members of the Board of Examiners, Appeals and Condemnation shall have the right of reasonable inspection of any building for the purpose of determining the condition thereof. No person shall refuse or interfere with such inspection by any such official.
- B. For the purpose of such inspection, the Building Official may order any structural member or portion of the structural frame of any building, whether such building is already erected, or is in course of construction, to be exposed whenever he or she has reasonable grounds for believing that such structural member or frame is in an unsafe condition or does not conform to the requirements of this chapter. No owner, reputed owner or person having custody, control or management or in charge of maintenance, occupancy or use of such building who is served with such order shall fail or refuse to forthwith fully uncover or expose the portion of the structural frame or structural member as required by such order.

18.20.100 – Dangerous buildings or conditions—Abatement proceedings.

All buildings or portions thereof which are determined to be dangerous as defined in Section 18.02.050 are public nuisances and shall be abated under the procedures set forth in this chapter for abatement of nuisances.

18.20.110 – Dangerous buildings or conditions—Summary abatement.

Where necessary in the opinion of the Building Official to protect life or property from an acutely dangerous condition, the Building Official may take emergency action to abate the hazard by City forces as provided in this chapter or may order the building immediately vacated, posted unsafe, barricaded, utilities disconnected, or other appropriate protective remedy.

18.20.120 – Inspection of buildings—Report.

If the building is not demolished, the substandard conditions corrected, or the nuisance otherwise abated, on or before the expiration of the time specified in the posted notice, the Building Official shall cause such building to be thoroughly inspected and shall make a written report or record of his findings with respect thereto. Copies of such report shall be filed with the Board of Examiners, Appeals and Condemnation.

18.20.130 – Hearing by Board of Examiners, Appeals and Condemnation.

- A. Following the filing by the Building Official of his or her findings in connection with the condemnation of a building as being substandard or as being a public nuisance, the Building Official shall notify the members of the Board of Examiners, Appeals and Condemnation of such filing and shall notify other interested persons of the time and place for a hearing before the Board for the purpose of passing upon the findings of the Building Official. The Board may conduct an independent investigation into the facts of such matter and the members thereof, or their authorized representatives, may inspect any building or structure involved therein.
- B. Notice of the time and place of such hearing shall be given by the Secretary of the Board to the owner and other parties owning an interest in the substandard building. The notice must be served at least ten (10) days prior to the date fixed for such hearing.
- C. Any person claiming an interest in the building which is the subject of the hearing may appear before the Board and object to the condemnation. The Board shall take such evidence as may be necessary to determine whether the building or structure is substandard or is a public nuisance. Upon or after the conclusion of the hearing, the Board shall determine whether the building or structure is substandard or a nuisance and what alterations or repairs, if any, could be made in order to correct the substandard conditions or to abate the nuisance, or whether the total demolition thereof is required; the Board may establish a time not to exceed sixty (60) days, within which such repairs, alterations, or demolition shall be completed. The time period may, upon written request, be extended for a period not to exceed sixty (60) days if a determination is made by the Board that denial of the extension will result in substantial hardship to the owner.
- D. The Board shall make written findings of its determination in the manner aforesaid, and shall cause a copy thereof to be served upon the same persons and in the same manner elsewhere herein provided for service of the initial notice in connection with such proceedings. The time for completion of repairs or alterations, or the demolition of the building or structure, shall commence to run on the date such findings are either delivered, posted or mailed, as the case may be. Simultaneously with service of such written findings, a copy thereof shall be filed in the office of the Building Official.

18.20.140 – Appeals to City Council.

- A. Whenever any person is aggrieved by any final order of the Board of Examiners, Appeals and Condemnation, dealing with correction of substandard conditions or abatement of a nuisance, such person may, within fifteen (15) days after notice of such ruling or act has been served as hereinabove provided, appeal to the City Council by filing with the City Clerk a written statement of the rulings or acts complained of and the reasons for taking such appeal. The City Clerk shall thereupon refer such appeal to the City Council at its next regular meeting, and the Council shall thereupon fix a time for the hearing of the matter by the Council, which time shall be not less than ten (10) days nor more than thirty (30) days from the time the hearing date is set. On the date

thus fixed, or on the date to which the hearing has been continued, the Council shall proceed to hear and consider the evidence relating to the matter and shall make and enter on its minutes its final determination therein. The Council may confirm, modify or set aside the findings of the Board, and its determination in the matter shall be final and conclusive. No proceeding or action shall be against the City nor against the Council nor the Board nor any member of either thereof, nor against any officer, agent or employee of the City to review or enjoin the enforcement of its determination or orders of the Council made pursuant hereto, or to recover damages for carrying out such orders in a lawful and reasonable manner unless such action is commenced within thirty (30) days from and after service of notice of the findings and determination of the Council.

- B. Notice of the determination of the Council shall be served by the City Clerk upon the person or persons taking the appeal in the manner elsewhere provided in this chapter for service of notices.
- C. The effect of any order from which an appeal is taken as herein provided shall be suspended and of no force and effect until such appeal is fully determined.

18.20.150 - Demolition or repairs by City—Expense liability.

- A. Within the limitations of the budget, the Building Official may cause to be demolished, altered or repaired, at City expense, any building found by the Board of Examiners, Appeals and Condemnation to constitute a substandard building or to be a public nuisance which has not been demolished, altered or repaired within the time established by and in accordance with the determination of the Board or, in the event of an appeal, by the City Council. All expenses so incurred by him on behalf of the City in connection therewith, including the applicable processing costs as set forth in the schedule of fees and charges established by City Council resolution, and incidental enforcement costs shall become an indebtedness of the owner of such building or structure, and thereupon a lien shall attach to the parcel of real property upon which is located the building which is the subject of the proceedings. Such lien shall remain in effect until either:
 - 1. The substandard conditions shall have been corrected or the nuisance abated;
 - 2. If corrected or abated by the Building Official, payment in full of costs of correction or abatement, and accrued interest and penalties, if any, has been made; or
 - 3. The order requiring correction of substandard conditions or abatement is reversed on appeal to the City Council or by a final judgment of a court of competent jurisdiction.
- B. Any person having the legal right to do so may repair or demolish a substandard building prior to such action by the City, but if the work is performed after the deadline established by the Board of Examiners, Appeals and Condemnation or, in the event of an appeal, by the City Council, the appropriate processing and other costs incurred by the City in preparing to do the work and all incidental enforcement costs are chargeable to the property.

18.20.160 – Service of notices and orders.

- A. All notices and orders provided for by this chapter shall be in writing, shall state in general terms wherein the building or structure is unsafe or dangerous, or in what manner it is substandard, or in what manner it constitutes a public nuisance, and the minimum requirements for its correction, or total costs that will be charged to the owner of the property. Service of such order shall be upon the owner thereof or upon the person causing or permitting the condition to exist, or the person having the custody, control, maintenance, occupancy, use or management of the building, and upon any lessee or mortgagee thereof if shown on the official records of the county, by delivering the same to either of said persons or their agents in charge of the building. As an alternate method of such service, such notice may be served by registered United States mail with return receipt requested. Service by this method shall be deemed complete upon deposit of such notice in the United States mail with prepaid postage affixed. If, after reasonable diligence, either the identity of the owner thereof cannot be ascertained or such owner cannot be located,

then such order shall be posted in one or more conspicuous places upon or near the entrance to the building.

- B. Whenever the Building Official posts such a notice upon the property, it shall be posted at one (1) or more conspicuous places upon the building and shall be in substantially the following form:

NOTICE

To all persons owning or claiming any interest in this building:

You are notified that the Building Official of the City of Long Beach has determined that this building is (insert substandard or a nuisance) by reason of the following facts:

Pursuant to the provisions of the building regulations of the Long Beach Municipal Code, this building is hereby condemned and the owner or owners of said building are hereby directed to correct deficiencies therein or to abate a nuisance existing therein or thereon. Further particulars regarding the facts may be obtained at the office of the Development Services Department of the City of Long Beach.

Unless this building is (how to be corrected or demolished) in the manner hereinabove specified, on or before the _____ day of _____ 20_____, the Building Official of the City of Long Beach may cause such work to be done for and on behalf of the owner of said building, and all expenses incurred by the City for such work will be charged to, and become an indebtedness of, the owner or owners of said building to the City of Long Beach, and will become a lien against the real property on which such building is situated.

Dated and posted this _____ day of _____ 20_____.

Building Official, City of Long Beach

- C. Not less than five (5) days after the aforesaid notice is posted on the building, an additional copy of such notice shall be served in the manner hereinabove provided upon the person or persons shown by the current county assessment roll to be the owner or owners of the building, or of any interest therein, including lessees and mortgagees, at the address shown thereon or to any known more recent address, or in the absence of any address then in care of general delivery, at Long Beach.
- D. No owner or other person causing or permitting such condition to exist shall fail or refuse, after delivery or posting of such order, to correct such condition in accordance with the requirements of the order.

18.20.170 – Extensions of time to perform work.

Any time limit prescribed in this chapter for the doing of an act by an occupant or owner of a building or by the Building Official may for good cause be extended by the Building Official, and failure to require the doing of any act authorized in this chapter to be required by him within the time limit prescribed in this chapter shall not affect the validity of any order made thereafter.

18.20.180 – Owner's responsibility for enforcement costs.

If the substandard conditions have not been corrected or the nuisance abated by the owner as directed within the time frame established by the Building Official, or as said time frame may be modified on appeal to the Board of Examiners, Appeals and Condemnation or City Council, all incidental enforcement costs incurred by the City in connection therewith shall be charged to and become an indebtedness of the owner of such property, except as provided below, whether or not the

work is later performed by the City, by the owner, or by others. "Incidental enforcement costs" include, but are not limited to, the actual expenses and costs of the City in investigating the nuisance, obtaining title information, preparing notices, and performing inspections. Incidental enforcement costs shall not be charged to, nor become an indebtedness of, a property owner who is the head of a low-income household (defined to be a household earning less than eighty percent of the county median income).

18.20.190 – Abatement charges.

When a building has been demolished, altered or repaired by the Building Official at City expense as authorized by Section 18.20.150, or when the owner is responsible for incidental enforcement costs as provided by Section 18.20.180, the Building Official shall prepare a sworn statement showing the costs thereof. The Building Official shall thereupon give notice of the amount of such charges in the same manner as elsewhere provided in this chapter for service of notices.

18.20.200 – Hearing on charges.

Within thirty (30) days from the date of service of such notice the property owner, or any interested person, may demand a hearing as to the reasonableness of the charges. Such demand shall be in writing and filed with the Building Official. It shall describe the property involved, state the reasons for objecting, and include the address of the applicant for service of notices in connection with such hearing. Such demand shall be presented by the Building Official to the Board of Examiners, Appeals and Condemnation for hearing at its next regular meeting that is not less than ten (10) and not more than forty-five (45) days thereafter. The Building Official shall give written notice of such hearing to the address furnished in the demand for hearing in the manner elsewhere provided in this chapter for service of notices. At the time set for such hearing, the Board of Examiners, Appeals and Condemnation shall hear all evidence pertinent to the reasonableness of such charges and shall then either confirm or modify the charges. The decision of the Board of Examiners, Appeals and Condemnation thereon shall be final.

18.20.210 – Interest on charges.

If the amount of the charges as determined by the Board of Examiners, Appeals and Condemnation has not been paid within thirty (30) days after the date of hearing, the payment thereof shall thereupon become delinquent and the amount so determined shall thereafter bear interest at the rate of twelve percent (12%) until paid, as determined by the tax collector. If no hearing is demanded as to the reasonableness of the charges, the payment thereafter shall become delinquent sixty (60) days after notice of the charges for abatement is served by the Building Official; and such amount shall thereafter bear interest at the rate of twelve percent (12%) until paid, as determined by the tax collector.

18.20.220 – Transfer of collection.

The Building Official shall certify a list of all delinquent charges for correction of substandard conditions or nuisance abatement to the tax collector. Each parcel of property shall be described sufficiently to identify it in accordance with the records of the tax collector. The amount of the charges including such interest as has accrued after the delinquent date to July 1 of the year shall be set forth opposite the description by the tax collector.

18.20.230 – Method of collection.

Upon receipt of the list the tax collector shall enter the charges shown thereon for each parcel of property upon the current tax roll and shall proceed to collect the charges in the same manner as municipal ad valorem taxes, and penalties and interest for nonpayment thereafter shall attach as though the amounts were ad valorem taxes; provided, however, that no receipt for payment of ad valorem taxes appearing upon the tax roll as against a particular parcel shall be issued unless all

such charges for collection of substandard conditions or nuisance abatement, and penalties thereon, entered upon that tax roll against the lot are first paid in full.

18.20.240 – Tax-sold property.

Upon the sale of any lot to the City for nonpayment of taxes, all charges for correction of substandard conditions or nuisance abatement for the parcel appearing upon the tax roll, together with the penalties thereon, shall be added to and become a part of the same delinquent tax record.

18.20.250 – Tax-sold property—Redemptions.

No certificate of redemption from sale for delinquent taxes shall be issued until all charges for correction or substandard conditions and nuisance abatement, and penalties entered on the delinquent tax records against the property involved, have first been paid in full.

18.20.260 – Error correction—Assessment cancellation.

- A. The Building Official may, prior to certifying any such unpaid charges to the tax collector, correct any errors with respect to such taxes appearing upon his records.
- B. After such taxes have been certified to the tax collector, the Council, by order entered on its minutes, may cancel any charges for correction of substandard conditions or nuisance abatement, or penalty, or any portion of either thereof, appearing on the tax records, which, because of error, is charged against the wrong property, or which has been paid but such payment has not been recorded upon the tax records, or which is based upon a clerical error in such records, or which was charged against property acquired subsequent to the lien date by the United States, by the State, or any city, or any school district or other political subdivision and, because of this public ownership, not subject to sale for delinquent assessments.

18.20.270 – Refunds.

Any charge for correction of substandard conditions or for nuisance abatement or penalty, or portion of either thereof, which is paid as the result of an erroneous assessment upon the wrong property, or which is paid more than once, or which is based upon a clerical error appearing in the tax records, may be refunded by the Council to the person entitled thereto; provided, however, that such refunds shall only be made upon the written application of the person entitled thereto, which must be filed with the City Clerk not later than one year after the date the erroneous payment was made.

18.20.280 – Notice to secure structure.

When any unoccupied building or structure is not properly secured, locked or closed, and is accessible to juveniles, transients and undesirables, and is in such condition as to constitute an immediate health, fire or safety hazard and the Building Official determines that the hazard is such as to require immediate closure, he shall serve the record owner and the person having control of such building or structure with notice to secure or close the same forthwith so as to prevent unauthorized persons from gaining access thereto. Notice shall be served as provided in this chapter and shall state that if the required work is not performed within forty-eight (48) hours after service of the notice, the City will perform such work and all expenses incurred by the City including, but not limited to, incidental processing and enforcement costs shall become an indebtedness of the owner and a lien on the property. Collection of such charges shall be accomplished in accordance with this title and Chapter 8.56.

18.20.290 – Emergency hazard abatement.

When any open building or structure constitutes such a threat to life, limb or property that it must be secured, closed, barricaded or demolished forthwith and compliance with other provisions of this code become infeasible, as determined by a City officer charged with responsibility for enforcement of

health and safety regulations, the Director of Public Works may summarily secure, close, barricade or demolish such building or structure without prior notice to the property owner. All costs incurred by the City in abating the hazard shall be borne by the property owner and failure to receive prior notice shall not affect or relieve the property owner's obligation for payment of such costs.

18.20.300 – Criminal prosecution.

Pursuant to Section 1.32.010 of this code, any violation of the provisions of this Title 18 is a misdemeanor, and the notice, hearing, appeal and other administrative procedures contained in this Title 18 shall not be a condition precedent to any criminal prosecutions.

CHAPTER 18.21 MAINTENANCE OF LONG-TERM BOARDED AND VACATED BUILDINGS

18.21.010 – Purposes and definitions.

18.21.020 – Owner responsibilities.

18.21.030 – Monitoring program—Purpose.

18.21.040 – Monitoring program—Department responsibility and fees.

18.21.050 – Civil remedy.

CHAPTER 18.21 MAINTENANCE OF LONG-TERM BOARDED AND VACATED BUILDINGS

18.21.010 – Purposes and definitions.

- A. Purpose. Vacant buildings are a major cause and source of blight in both residential and non-residential neighborhoods, especially when the owner of the building fails to actively maintain and manage the building to ensure that it does not become a liability to the neighborhood. Vacant buildings (whether or not those buildings are boarded), substandard or unkempt buildings, and long-term vacancies discourage economic development and retard appreciation of property values. It is the responsibility of property ownership to prevent owned property from becoming a burden to the neighborhood and community and a threat to the public health, safety, or welfare. One vacant building which is not actively and well maintained and managed can be the core and cause of spreading blight.
- B. Definitions. For the purposes of this chapter, the term "boarded building" shall mean a building whose doors and windows have been covered with plywood or other material for the purpose of preventing entry into the building by persons or animals.

18.21.020 – Owner responsibilities.

- A. No person shall allow a building or structure designed for human, industrial, or commercial use, or occupancy to stand vacant for more than thirty (30) days unless one of the following applies:
 - 1. The building is the subject of an active building permit for repair or rehabilitation, or a permit for demolition, and the owner is progressing diligently to complete the repair or rehabilitation;
 - 2. The building meets all applicable codes, does not contribute to blight, is ready for occupancy and is actively being offered for sale, lease, or rent;
 - 3. The Building Official or designee determines that the building does not contribute to, and is not likely to contribute to, blight because the owner is actively maintaining and monitoring the building so that it does not contribute to blight. Active maintenance and monitoring shall include:
 - a. Maintenance and appropriate watering and care of landscaping and plant materials,
 - b. Maintenance of the exterior of the building, including but not limited to, paint and finishes, in good condition,
 - c. Regular removal of all trash, debris and graffiti,
 - d. Maintenance of the building or structure in continuing compliance with all applicable codes and regulations,
 - e. Prevention of criminal activity on the premises, including, but not limited to, use and sale of controlled substances, prostitution, or other criminal street gang activity.
- B. "Vacant building" or "vacant structure" shall mean a building which is without a lawful resident or occupant or which is not being put to a lawful commercial, residential, or industrial use, and which may be unoccupied and unsecured; occupied and secured by boarding or other similar means; unoccupied and a dangerous structure or; unoccupied with multiple City municipal code or nuisance violations.
- C. The owner of any vacant or boarded building or structure, whether boarded by voluntary action of the owner or as a result of enforcement activity by the City, shall cause the boarded or vacant

building to be rehabilitated for occupancy within sixty (60) days after the building or structure is boarded or becomes unoccupied.

18.21.030 – Monitoring program—Purpose.

- A. Vacant buildings are a major cause and source of blight in residential and nonresidential neighborhoods, especially when the owner of the building fails to maintain and manage the building to ensure that it does not become a liability to the neighborhood. Vacant buildings often attract transients and criminals, including drug users. Use of vacant buildings by transients and criminals, who may employ primitive cooking or heating methods, creates a risk of fire for the vacant buildings and adjacent properties. Vacant properties are often used as dumping grounds for junk and debris and are often overgrown with weeds and grass. Vacant buildings which are boarded up to prevent entry by transients and other long-term vacancies discourage economic development and retard appreciation of property values.
- B. Because of the potential economic and public health, welfare and safety problems caused by vacant buildings, the City needs to monitor vacant buildings, so that they do not become attractive nuisances, are not used by trespassers, are properly maintained both inside and out, and do not become a blighting influence in the neighborhood. City Departments involved in such monitoring include the Police, Fire, Health, and Development Services Departments. There is a substantial cost to the City for monitoring vacant buildings (whether or not those buildings are boarded up) which should be borne by the owners of the vacant buildings.

18.21.040 – Monitoring program—Department responsibility and fees.

- A. Purpose. The Building Official or designee shall be responsible for administering a program for identifying and monitoring the maintenance of all vacant buildings or structures in the City.
- B. Purposes. The purposes of the monitoring program shall be:
 - 1. To identify buildings that become vacant;
 - 2. To order vacant buildings that are open and accessible to be secured against unlawful entry per Long Beach Municipal Code Section 18.20.280;
 - 3. To initiate proceedings against any vacant or boarded building or structure found to be substandard as defined in this title; and
 - 4. To maintain surveillance over vacant or boarded buildings so that timely code enforcement proceedings are commenced in the event a building becomes substandard or a public nuisance.
- C. Notice of vacant building.
 - 1. Upon discovery of a potential vacant building by a code enforcement officer or receipt of a complaint about a vacant or boarded building from any source, the City may cause an inspection of the property in order to determine if the building or structure should be classified as a vacant building;
 - 2. If the City determines that a building or portion of a building may be classified as a vacant building under this chapter, the City shall ascertain the identity of, and contact the owner or agent of the owner, and advise the owner in writing that the building or structure is vacant and that the following measures need to be taken by the owner:
 - a. Immediate measures to temporarily secure the building or structure from unauthorized entry,

- b. Measures to permanently secure the building during the period of time that the building or structure remains vacant,
 - c. The posting of a sign or signs on the property in a conspicuous place, as determined by the City, which sign(s) shall notify the public of the owners or authorized agents' name and address and an emergency contact telephone number;
3. If the City determines that a building or structure is vacant it shall cause a "Notice of Vacant Building" to be recorded against the title of the property, which notice shall make reference to the provisions of this chapter and disclose that administrative penalties and costs may likewise be assessed against the owner and property as a result of the building or structure remaining in a vacant condition;
 4. If the owner fails to take immediate measures to temporarily or permanently secure the building from unauthorized entry, the vacant building shall constitute a nuisance and the City may, without further notice, and by any lawful means, abate the nuisance. In this event, the owner shall be liable for the costs incurred by the City for inspections or to secure the building or structure, including costs incurred to ascertain ownership of the property and obtaining title information, preparing notices, and any and all administrative costs together with actual labor or material cost or expense incurred by the City to secure the building or structure or otherwise abate the nuisance. If the owner does not reimburse the City within thirty (30) days of being billed therefore, the City may file a lien against the property for all of the expenses incurred by the City.

D. Optional vacant building plan and timetable.

1. If the owner of a vacant building files a vacant building plan and timetable with the City not later than seven (7) days after the owner or agent of the owner receives written notice pursuant to Subsection 18.21.040.C, the City is authorized to:
 - a. Suspend the processing of any citation or other remedy for violation of this chapter,
 - b. Extend the period of time in which the owner of a vacant building must secure the building;
2. The vacant building plan and timetable must be submitted on forms prepared by the City and must include, at a minimum, the following information:
 - a. A description of the premises, including the address thereof,
 - b. The names, addresses, and telephone numbers of all owners with a right of control over the vacant building or structure,
 - c. The names and addresses of all known lien holders and all other parties with an ownership interest in the vacant building or structure,
 - d. The name, address and telephone number of the owner's property manager or agent, and whether the property manager or agent has the authority to independently act on the owner's behalf to repair or maintain the property,
 - e. The period of time the building is expected to remain vacant,
 - f. If the owner plans on demolishing the building, the date the building is scheduled for demolition, and whether or not a permit has been issued for said demolition,

- g. If the owner plans on returning the building to a lawful occupancy and use, the estimated date for returning the building to a lawful occupancy or use, and whether or not a permit has been issued to return the vacant building to a lawful occupancy or use,
 - h. A plan for regular inspection and maintenance of the building during the period of vacancy,
 - i. Measures the owner will employ to secure the building to prevent access by trespassers. One of the following methods must be used to secure the building as specified in the discretion of the City:
 - i. Installation of adequate windows and doors, or window and door coverings,
 - ii. Installation and maintenance of adequate locks for windows and doors,
 - iii. Installation of boards on windows and doors or security screening to the satisfaction of the City,
 - iv. Employment of security officers to the satisfaction of the City,
 - v. Installation, operation, and monitoring of an electronic security system, which monitors doors and windows by glass breakage or motion sensors, and a method of responding to alarms from the electronic security system, other than sole reliance on the City's Police Department,
 - vi. Any other methods as specified by the City,
 - j. Measures the owner will employ to monitor and inspect the property on a weekly basis. The weekly monitoring and inspection must be performed by the owner, property manager, or agent of the owner with full authority to maintain and make repairs to the property on a weekly basis;
- 3. The plan and timetable submitted by the owner or agent of the owner must be approved by the City. Any and all repairs required to effect the plan and timetable shall comply with all applicable City of Long Beach ordinances, codes and regulations. The owner shall be required to notify the City in writing of any changes in information supplied as part of the vacant building plan and timetable within ten (10) days of the change;
 - 4. During the period of time that the vacant building plan and timetable are in effect, the owner shall be responsible for paying to the City the monthly monitoring fee as said fee is established, and from time to time amended, in accordance with a duly adopted resolution of the City Council;
 - 5. In the event that the owner fails to comply with the vacant building plan and timetable, the City shall so notify the owner or authorized agent and shall thereafter institute appropriate administrative, civil or other legal action to secure compliance with this chapter.
- E. Monitoring fee imposed. Any vacant or boarded building or structure as defined in this chapter shall be subject to a monthly monitoring fee, to recover the City's regulatory costs to monitor the status of the vacant or boarded building. The monthly monitoring fee shall be set by resolution of the City Council. The monitoring fee shall be applicable until such time as the building or structure is no longer vacant or boarded, and shall likewise be applicable even when a vacant building plan and timetable is in effect. The monitoring fee shall be imposed upon the initial determination that the building is vacant. The fee shall thereafter be imposed in each thirty (30) day period following the imposition of the initial monitoring fee, to be billed to the owner on a quarterly basis until such time as the building or structure is no longer vacant or boarded.

- F. Code enforcement response fee. In addition to the monthly monitoring fee imposed pursuant to this section, the City also establishes a further and separate enforcement response fee for actual costs incurred by the City to respond to or abate substandard or blighted conditions existing in or about the property upon which the boarded or vacant building or structure is located. Such costs shall include, but not be limited to, personnel costs involved with inspecting or responding to calls for service at the property, personnel costs involved in abating the substandard or blighted conditions existing on the property, costs of any materials or supplies either purchased or supplied by the City in connection with the abatement of any substandard or blighted condition in or about the property, costs of any contracted services, including the costs of materials, supplies, and labor provided by the City's contractor, if any, costs of procuring title or ownership information concerning or related to the property, as well as any other incidental enforcement costs incurred by the City in connection with remedying the substandard or blighted conditions existing on the property. The amount of the code enforcement response fee shall be established by resolution of the City Council.
- G. Procedure. The vacant or boarded building monitoring fee and the code enforcement response fee, if any, shall be billed to the owner of the property and mailed to the owner's address as set forth on the last equalized assessment roll of the county assessor. Said fee or fees and associated administrative costs shall be charged to and become an indebtedness of the owner of the property.
- H. If the monthly monitoring or code enforcement response fees or associated administrative costs and expenses are not paid within thirty (30) days after billing, then the fee or costs may be specially assessed against the property involved. If the fees or costs are specially assessed against the property, said assessment may be collected at the same time and in the same manner as ordinary real property taxes are collected and shall be subject to the same penalties and the same procedure and sale in case of delinquency as provided for ordinary real property taxes. All laws applicable to the levy, collection, and enforcement of real property taxes are applicable to the special assessment.
- I. The City may also cause a notice of lien to be recorded against the property. The notice shall, at a minimum, identify the record owner or possessor of the property, set forth the last known address of the record owner or possessor, a description of the real property subject to the lien, and the amount of the fee or costs assessed against the property.
- J. Hearing on charges. Within thirty (30) days from the date that the property owner is mailed a notice regarding the imposition of either monthly monitoring fees or code enforcement response fees or charges, the property owner may demand a hearing as to the reasonableness of the fees or charges imposed. Such demand shall be in writing and presented to the Director of Development Services for the City of Long Beach. Said demand shall describe the property involved, state the reasons for objecting, and include an address of the property owner for service of notice in connection with such hearing. Such demand shall be presented by the City to the Board of Examiners, Appeals and Condemnation for hearing at its next regularly scheduled meeting that is not less than ten (10) and not more than forty-five (45) days thereafter. The Director of Development Services shall give written notice of such hearing to the address furnished by the property owner in the demand for an appeal hearing. At the time set for such hearing, the Board of Examiners, Appeals and Condemnation shall hear all evidence pertinent to the reasonableness of such fees and charges and shall either confirm or modify the charges. The decision of the Board of Examiners, Appeals and Condemnation shall be final. If the amount of the charges is uncontested by the property owner or as set by the Board of Examiners, Appeals and Condemnation on appeal, has not been paid within thirty (30) days after imposition or appeal hearing whichever is later, the payment thereof shall thereupon become delinquent and the amount so imposed or determined shall thereafter bear interest at the rate of twelve percent (12%) per annum until paid, as determined by the tax collector.

18.21.050 – Civil remedy.

A. Penalty.

1. Any owner of a vacant or boarded building which remains boarded in violation of Subsection 18.21.020.B or any owner of a building which remains vacant or boarded in violation of Subsection 18.21.020.A shall be liable for an administrative penalty in an amount not to exceed one thousand dollars (\$1,000.00) per calendar year per building.
2. A second or subsequent administrative penalty imposed upon any owner pursuant to this section shall be in an amount not to exceed five thousand dollars (\$5,000.00).

B. Procedure.

1. The administrative penalty shall be imposed by the Board of Examiners, Appeals and Condemnation upon the recommendation of the Building Official or designee and after the owner shall have been afforded a hearing before the Board of Examiners, Appeals and Condemnation. The hearing shall be conducted in accord with the provisions of Chapter 18.10 and Chapter 18.20. In setting the penalty, the Board shall consider the severity of the blighting conditions on the property and the owner's efforts, or lack thereof, to remedy the problem. The decision of the Board shall be final.
2. The administrative penalty shall be due and payable within thirty (30) days after the decision of the Board. If the penalty is not paid within forty-five (45) days after the decision of the Board, the penalty shall become a personal indebtedness or obligation of the property owner or it may be specially assessed against the property involved. If the property is specially assessed said assessment may be collected at the same time and in the same manner as ordinary real property taxes are collected and shall be subject to the same penalties and the same procedure and sale in case of delinquency as provided for ordinary real property taxes. All laws applicable to the levy, collection, and enforcement of real property taxes are applicable to the special assessment.
3. The City may also cause a notice of lien to be recorded against the property. The notice shall, at a minimum, identify the record owner or possessor of the property and set forth the last known address of the record owner or possessor, the date on which the penalty was imposed, a description of the real property subject to the lien, and the amount of the penalty or costs assessed against the property.

CHAPTER 18.22 POLICE FACILITIES IMPACT FEE

- 18.22.010 – Legislative findings.
- 18.22.020 – Purpose.
- 18.22.030 – Definitions.
- 18.22.040 – Fund established.
- 18.22.050 – Police Facilities Impact Fee.
- 18.22.060 – Fee imposed.
- 18.22.070 – Calculation of Police Facilities Impact Fee.
- 18.22.080 – Payment of fee.
- 18.22.090 – Use of funds.
- 18.22.100 – Refund.
- 18.22.110 – Exemptions and credits.
- 18.22.120 – Appeals.
- 18.22.130 – Judicial review.
- 18.22.140 – Annual report and amendment procedures.
- 18.22.150 – Effect of Police Facilities Impact Fee on zoning and subdivision regulations.
- 18.22.160 – Violation—Penalty.
- 18.22.170 – Severability.

CHAPTER 18.22 POLICE FACILITIES IMPACT FEE

18.22.010 – Legislative findings.

- A. The State of California, through the enactment of Government Code Sections 66001 through 66009 has authorized the City to enact development impact fees.
- B. The imposition of development impact fees is one of the preferred methods of ensuring that development bears a proportionate share of the cost of capital facilities and related costs necessary to accommodate such development. This must be done in order to promote and protect the public health, safety and welfare.
- C. That the continuing increase in the development of residential and nonresidential construction in the City has created an urgency in that funds are needed for the increased demand for police services and the facilities that support those services which are required to serve the increasing residential and workforce population of the City.
- D. The fees established pursuant to this chapter are derived from, are based upon, and do not exceed the costs of providing additional police services attributable to new residential or nonresidential construction, including: master planning to more specifically identify capital facilities to serve new development; the acquisition of additional property for police facilities; the construction of buildings for police services; the furnishing of buildings or facilities for police services; and the purchasing of equipment and vehicles for police services.
- E. The fees collected pursuant to this chapter shall be used to finance the police facilities and equipment identified in Subsection 18.22.010.D.
- F. Detailed study of the impacts of future residential and nonresidential construction in the City, along with an analysis of the need for new police facilities and equipment has been prepared. This study is included in the "Public Safety Impact Fee Study" for the City of Long Beach dated August 18, 2006 which is incorporated herein by reference as though set forth in full, word for word.
- G. There is a reasonable relationship between the need for the police facilities and equipment set forth in Subsection 18.22.010.D and the impacts of the types of development for which the corresponding fee is charged.
- H. There is a reasonable relationship between the fee's use and the type of development for which the fee is charged.
- I. There is a reasonable relationship between the amount of the fee and the cost of the facilities and equipment or portion thereof attributable to the development on which the fee is imposed.

18.22.020 – Purpose.

A Police Facilities Impact Fee is imposed on residential and nonresidential development for the purpose of assuring that the impacts created by said development pay its fair share of the costs required to support needed police facilities and related costs necessary to accommodate such development.

18.22.030 – Definitions.

As used in this chapter:

- A. "Accessory use" is as defined in Section 21.15.060 of this code.

- B. "Applicant" means the property owner, or duly designated agent of the property owner, for which a request for building permit or construction approval for a mobilehome pad is received by the City.
- C. "Building permit" means the City permit required for new building construction and/or additions which add square footage pursuant to Title 18 of this code. Neither a grading permit nor a foundation permit shall be considered a building permit for purposes of this chapter.
- D. "Calculation" means the point in time at which the City calculates the Police Facilities Impact Fee to be paid by the applicant. Calculation will generally occur at the time of issuance of the applicable building permit or construction approval for a mobilehome pad but may occur earlier in the development approval process.
- E. "City Manager" means the City Manager of the City of Long Beach or other municipal officials he or she may designate to carry out the administration of this chapter.
- F. "Collect" or "collection" means the point in time at which the Police Facilities Impact Fees are paid by the applicant. Collection will occur on the date of final inspection or the date a Certificate of Occupancy or Temporary Certificate of Occupancy, whichever occurs first, or in the case of a mobilehome pad or pads, collection will occur at or on the date of construction approval is issued.
- G. "Development" means the addition of new dwelling units and/or new nonresidential square footage to an undeveloped, partially developed or redeveloped site and involving the issuance of a building permit and Certificate of Occupancy for such construction, reconstruction or use. Development also includes the approval and construction of new mobilehome pads in existing or new mobilehome parks or sites, but not including the following so long as no additional dwelling units or gross floor area is added:
 - 1. A permit to operate;
 - 2. A permit for the internal alteration, remodeling, rehabilitation, or other improvements or modifications to an existing structure;
 - 3. The rebuilding of a structure destroyed by an act of God or the rehabilitation or replacement of a building in order to comply with the City's seismic safety requirements;
 - 4. Parking facilities; or
 - 5. The rehabilitation or replacement of a building destroyed by imminent public hazard, acts of terrorism, sabotage, vandalism, warfare or civil disturbance except where said destruction was caused or in any manner accomplished, instigated, motivated, prompted, incited, induced, influenced, or participated in by any persons or their agents having any interest in the real or personal property at the location.
- H. "Dwelling unit" or "DU" is as defined in Section 21.15.910 of this code.
- I. "Fee-setting resolution" means and refers to the City resolution specifying the Police Facilities Impact Fee per dwelling unit or mobilehome pad for residential development and per gross square foot of floor area for nonresidential development, by type and by location. The Police Facilities Impact Fee set forth in the fee-setting resolution may be revised pursuant to Section 18.22.140 and applicable State law.
- J. "Gross square feet" or "gsf" means the area of a nonresidential development measured from the exterior building lines of each floor with respect to enclosed spaces but excluding parking spaces whether or not enclosed. For purposes of this chapter, the term "enclosed spaces" specifically includes, but is not limited to, an area available to and customarily used by the general public and

all areas of business establishments generally accessible to the public such as fenced, or partially fenced in areas of garden centers attached to and serving the primary structure.

- K. "Mixed use" is as defined in Section 21.15.1760 of this code.
- L. "Mobilehome" is as defined in Section 21.15.1770 of this code.
- M. "Nonresidential development" means a development undertaken for the purpose of creating gross floor area, excluding dwelling units, but which includes, and is not limited to, commercial, industrial, retail, office, hotel/motel, and warehouse uses involving the issuance of a building permit for such construction, reconstruction or use.
- N. "Police Department" means the Police Department of the City of Long Beach.
- O. "Principal use" is as defined in Section 21.15.2170 of this code.
- P. "Residential development" means a development undertaken for the purpose of creating a new dwelling unit or units and involving the issuance of a building permit and Certificate of Occupancy for such construction, reconstruction or use, or the construction approval for a mobilehome pad or pads.

18.22.040 – Fund established.

A Police Facilities Impact Fee fund is established. The Police Facilities Impact Fee fund is a fund to be utilized for payment of the actual or estimated costs of police facilities and equipment related to new residential and nonresidential construction as described in this chapter.

18.22.050 – Police Facilities Impact Fee.

There is imposed a Police Facilities Impact Fee on all new residential and nonresidential development as those terms are defined in this chapter.

18.22.060 – Fee imposed.

- A. Any person who, after the effective date of this chapter, seeks to engage in residential or nonresidential development including mobilehome development as defined in this chapter by obtaining a building permit or construction approval for a mobilehome pad or pads is required to pay a Police Facilities Impact Fee in the manner and amount as set forth in the then current fee-setting resolution. The Police Facilities Impact Fee imposed pursuant to this chapter shall not apply to those projects for which a Planning Bureau application for conceptual or site plan review has been filed and deemed complete by the Department of Development Services by April 3, 2007.
- B. No Certificate of Occupancy, Temporary Certificate of Occupancy, final inspection approval or construction approval for a mobilehome pad or pads, as applicable, for the activities listed in Subsection 18.22.060.A shall be issued unless and until the Police Facilities Impact Fee required by this chapter has been paid to the City.

18.22.070 – Calculation of Police Facilities Impact Fee.

- A. The Director shall calculate the amount of the applicable Police Facilities Impact Fee due as specified in the then current fee-setting resolution.
- B. The Director shall calculate the amount of the applicable Police Facilities Impact Fee due by:
 - 1. Determining the number and type of dwelling units in a residential development or mobilehome pads in a mobilehome park or site, and multiplying the same by the Police

- Facilities Impact Fee amount per dwelling unit or pad as established by the then current fee-setting resolution;
2. Determining the gross square feet of floor area, type of use and location in a nonresidential development, and multiplying the same by the Police Facilities Impact Fee amount as established by the then current fee-setting resolution;
 3. Determining the number and type of dwelling units and the nonresidential number of gross square feet of floor area, type of use and location, in a structure containing mixed uses which include a residential use, and multiplying the same by the Police Facilities Impact Fee amount for each use as established by the then current fee-setting resolution;
 4. Determining the gross square feet of floor area, type of use and location in a structure containing mixed uses which include two (2) or more nonresidential principal uses, and multiplying the same by the Police Facilities Impact Fee amount as established by the then current fee-setting resolution. The gross square feet of floor area of any accessory use will be charged at the same rate as the predominant principal use unless the Director finds that the accessory use is related to another principal use.

18.22.080 – Payment of fee.

- A. The City shall collect from the applicant the Police Facilities Impact Fee prior to the issuance of a Certificate of Occupancy, Temporary Certificate of Occupancy, final inspection or construction approval for mobilehome pad or pads, whichever occurs first.
- B. Except for an administrative charge that shall be allocated to the Department of Development Services, all funds collected shall be properly identified and promptly transferred for deposit in the Police Facilities Impact Fee fund and used solely for the purposes specified in this chapter.

18.22.090 – Use of funds.

- A. Funds collected from the Police Facilities Impact Fee shall be used to fund the costs of providing additional police services attributable to new residential and nonresidential construction and shall include:
 1. The acquisition of additional property for law enforcement facilities;
 2. The construction of new buildings for law enforcement services;
 3. The furnishing of new buildings or facilities for law enforcement services;
 4. The purchasing of equipment and vehicles for law enforcement services;
 5. The funding of a master plan to identify capital facilities to serve new Police Department development;
 6. The cost of financing (e.g., interest payments) related to Subsections 1 through 5, inclusive.
- B. Funds shall not be used for periodic or routine maintenance.
- C. In the event that bonds or similar debt instruments are issued for advanced provision of capital facilities for which Police Facilities Impact Fees may be expended, impact fees may be used to pay debt service on such bonds or similar debt instruments to the extent that the facilities provided are of the type described in Subsection 18.22.090.A.
- D. Funds may be used to provide refunds as described in Section 18.22.100.

18.22.100 – Refund.

- A. Any applicant who has paid a Police Facilities Impact Fee pursuant to this chapter may apply for a full or partial refund of same, if, within one year after collection of the Police Facilities Impact Fee the development project has been modified, pursuant to appropriate City ordinances and regulations, resulting in a reduction in the number of dwelling units, a change in the type of dwelling units, a reduction in square footage, or the applicability of an exemption pursuant to Section 18.22.110 of this chapter. The City shall retain a sum equaling twenty percent (20%) of the impact fee paid by the applicant to offset the administrative costs of refund. The applicant must submit an application for such a refund in accordance with Chapter 3.48 of this code. In no event shall a refund exceed the amount of the Police Facilities Impact Fee actually paid.

- B. Any funds not expended, encumbered or obligated by issued indebtedness by the end of the calendar quarter immediately following five years from the date the Police Facilities Impact Fee was paid shall, upon application of the then current landowner, be returned to such landowner with interest at a rate equal to the rate of interest earned by the City from the time the fee was paid, provided that the landowner submits an application for a refund within one hundred eighty (180) calendar days from the expiration of the five-year period.

18.22.110 – Exemptions and credits.

- A. Exemptions. Any claim of exemption must be made no later than the time of application for a building permit or mobilehome construction approval. The following shall be exempted from payment of the Police Facilities Impact Fee:
 - 1. Alterations or expansion of an existing residential building where no additional dwelling units are created and where the use is not changed;
 - 2. The replacement of a building or structure destroyed by fire, flood, earthquake or other act of God, with a new building or structure of the same size and use;
 - 3. The installation of a replacement mobilehome on a lot or other such site when a Police Facilities Impact Fee for such mobilehome site has previously been paid pursuant to this chapter, or where a mobilehome legally existed on such site on or prior to the effective date of the ordinance codified in this chapter;
 - 4. Nonresidential development. Construction or occupancy of a new nonresidential building or structure or an addition to or expansion of an existing nonresidential building or structure of three thousand (3,000) gross square feet or less;
 - 5. Residential development. Construction, replacement or rebuilding of a single-family dwelling (one unit per lot) on an existing lot of record, or the replacement of one (1) mobilehome with another on the same pad, or the moving and relocation of a single-family home from one (1) lot within the City to another lot within the City, or the legalization of an illegal dwelling unit existing prior to January 1, 1964, for which an administrative use permit is approved in accordance with Section 21.25.403(D). This exemption shall not apply to tract development, to the development of more than one (1) unit per lot nor to the replacement of a single-family dwelling with more than one (1) dwelling unit;
 - 6. Affordable Housing for Lower Income Households. Property rented, leased, sold, conveyed or otherwise transferred, at a rental price or purchase price which does not exceed the "affordable housing cost" as defined in Section 50052.5 of the California Health and Safety Code when provided to a "lower income household" as defined in Section 50079.5 of the California Health and Safety Code or "very low-income household" as defined in Section 50105 of the California Health and Safety Code. This exemption shall require the applicant to execute an agreement to guarantee that the units shall be maintained for lower and very low-income households whether as units for rent or for sale or transfer, for the lesser of a period

of thirty (30) years or the actual life or existence of the structure, including any addition, renovation or remodeling thereto. The agreement shall be in the form of a deed restriction or other legally binding and enforceable document acceptable to the City Attorney and shall bind the owner and any successor-in-interest to the real property being developed. The agreement shall subordinate, if required, to any State or federal program providing affordable housing to lower and very low-income households. The agreement shall be recorded with the Los Angeles County Recorder prior to the issuance of a Certificate of Occupancy. The City's Housing and Community Improvement Bureau shall be notified of pending transfers or purchases and give its approval of the purchaser's qualifying income status and purchase price, prior to the close of escrow. The City's Housing and Community Improvement Bureau shall be notified of pending rentals and give its approval of proposed tenant's qualifying income status and rental rate, prior to the tenant's occupancy. Applicant or any successor-in-interest shall be required to provide annually, or as requested, the names of all tenants or purchasers, current rents, and income certification to insure compliance. Voluntary removal of the housing restriction or violation of the restriction shall be enforced by the City's Housing and Community Improvement Bureau and shall require the applicant or any successor-in-interest to pay the then applicable Police Facilities Impact Fee at the time of voluntary conversion or as imposed at the time of violation on the unit in violation, plus any attorneys' fees and costs of enforcement, if applicable;

7. Hospitals as that term is defined in Section 21.15.1370 of this code.

- B. Credits. Any applicant whose development is located within a Community Facilities District (CFD), and is subject to the assessments thereof, shall receive an offset credit towards the fees established by this chapter to the extent that the assessments fund improvements within the CFD which would otherwise be funded by the development impact fees established by this chapter.

18.22.120 – Appeals.

- A. An applicant may appeal, by protest, any imposition of the Police Facilities Impact Fee by filing a notice of appeal with the City Clerk within ninety (90) days after the applicant pays the required fee.
- B. A valid appeal by protest of the imposition of the Police Facilities Impact Fee shall meet all of the following requirements:
1. Tendering in advance of the appeal any required payment in full or providing assurance of payment satisfactory to the City Attorney;
 2. Serving written notice on the City including:
 - a. A statement that the required payment has been tendered under protest or that required conditions have been satisfied;
 - b. A statement informing the City of the factual elements of the dispute and the legal theory forming the basis of the protest;
 - c. The name and address of the applicant;
 - d. The name and address of the property owner;
 - e. A description and location of the property;
 - f. The number of residential units or nonresidential gross square footage proposed, by land use or dwelling unit type, as appropriate; and
 - g. The date of issuance of the building permit.

- C. The City Council shall schedule a hearing and render a final decision on the applicant's appeal within sixty (60) days after the date the applicant files a valid appeal.
- D. The City Council hearing shall be administrative. Evidence shall be submitted by the City and by the applicant and testimony shall be taken under oath.
- E. The burden of proof shall be on the applicant to establish that the applicant is not subject to the imposition of the Police Facilities Impact Fee pursuant to the express terms of this chapter and applicable State law.
- F. If the Police Facilities Impact Fee has been paid in full or if the notice of appeal is accompanied by a cash deposit, letter of credit, bond or other surety acceptable to the City Attorney in an amount equal to the Police Facilities Impact Fee calculated to be due, the application for the building permit or mobilehome construction approval shall be processed. The filing of a notice of appeal shall not stay the imposition or the collection of the Police Facilities Impact Fee calculated by the City to be due unless sufficient and acceptable surety has been provided.
- G. Any petition for judicial review of the City Council's final decision shall be made in accordance with applicable State law and pursuant to Section 18.22.130.

18.22.130 – Judicial review.

- A. Any judicial action or proceeding to attack, review, set aside, void or annul the ordinance codified in this chapter, or any provision thereof, or resolution, or amendment thereto, shall be commenced within ninety (90) days of the effective date of the ordinance codified in this chapter, resolution, or any amendment thereto.
- B. Any judicial action or proceeding to attack, review, set aside or annul the imposition or collection of a Police Facilities Impact Fee on a development shall be preceded by a valid appeal by protest pursuant to Section 18.22.120 hereof and a final decision of the City Council pursuant thereto and shall be filed and service of process effected within ninety (90) days after the hearing on appeal regarding the imposition of a Police Facilities Impact Fee upon the development.

18.22.140 – Annual report and amendment procedures.

- A. Within one hundred eighty (180) days after the last day of each fiscal year, the Police Chief of the City of Long Beach shall evaluate progress in implementation of the Police Facilities Impact Fee program and shall prepare a report thereon to the City Council in accordance with Government Code Section 66006 incorporating among other things:
 - 1. The police facilities and equipment commenced, purchased or completed utilizing monies from the Police Facilities Impact Fee fund;
 - 2. The amount of the fees collected and the interest earned;
 - 3. The amount of Police Facilities Impact Fees in the fund; and
 - 4. Recommended changes to the Police Facilities Impact Fee, including, but not necessarily limited to, changes in the Police Facilities Impact Fee chapter or fee-setting resolution.
- B. Based upon the report and such other factors as the City Council deems relevant and applicable, the City Council may amend the ordinance codified in this chapter or the fee-setting resolution implementing this chapter. Changes to the Police Facilities Impact Fee rates or schedules may be made by amending the fee-setting resolution. Any change which increases the amount of the Police Facilities Impact Fee shall be adopted by the City Council only after a noticed public hearing. Nothing herein precludes the City Council or limits its discretion to amend the ordinance

codified in this chapter or the fee-setting resolution establishing Police Facilities Impact Fee rates or schedules at such other times as may be deemed necessary.

18.22.150 – Effect of Police Facilities Impact Fee on zoning and subdivision regulations.

This chapter shall not affect, in any manner, the permissible use of property, density/intensity of development, design and improvement standards and public improvement requirements or any other aspect of the development of land or construction of buildings, which may be imposed by the City pursuant to the City's zoning regulations, subdivision regulations or other ordinances or regulations of the City, which shall be operative and remain in full force and effect without limitation with respect to all residential and nonresidential development.

18.22.160 – Violation—Penalty.

A violation of this chapter shall be prosecuted in the same manner as misdemeanors are prosecuted; and upon conviction, the violator shall be punishable according to law. However, in addition to or in lieu of any criminal prosecution, the City shall have the power to sue in civil court to enforce the provisions of this chapter.

18.22.170 – Severability.

If any section, phrase, sentence, or portion of this chapter is for any reason held invalid or unconstitutional by any court of competent jurisdiction, such portions shall be deemed a separate, distinct, and independent provision; and such holding shall not affect the validity of the remaining portions thereof.

CHAPTER 18.23 FIRE FACILITIES IMPACT FEE

- 18.23.010 – Legislative findings.
- 18.23.020 – Purpose.
- 18.23.030 – Definitions.
- 18.23.040 – Fund established.
- 18.23.050 – Fire Facilities Impact Fee.
- 18.23.060 – Fee imposed.
- 18.23.070 – Calculation of Fire Facilities Impact Fee.
- 18.23.080 – Payment of fee.
- 18.23.090 – Use of funds.
- 18.23.100 – Refund.
- 18.23.110 – Exemptions and credits.
- 18.23.120 – Appeals.
- 18.23.130 – Judicial review.
- 18.23.140 – Annual report and amendment procedures.
- 18.23.150 – Effect of Fire Facilities Impact Fee on zoning and subdivision regulations.
- 18.23.160 – Violation—Penalty.
- 18.23.170 – Severability.

CHAPTER 18.23 FIRE FACILITIES IMPACT FEE

18.23.010 – Legislative findings.

- A. The State of California, through the enactment of Government Code Sections 66001 through 66009 has authorized the City to enact development impact fees.
- B. The imposition of development impact fees is one of the preferred methods of ensuring that development bears a proportionate share of the cost of capital facilities and related costs necessary to accommodate such development. This must be done in order to promote and protect the public health, safety and welfare.
- C. That the continuing increase in the development of residential and nonresidential construction in the City has created an urgency in that funds are needed for the increased demand for fire services and the facilities that support those services which are required to serve the increasing residential and workforce population of the City.
- D. The fees established pursuant to this chapter are derived from, are based upon, and do not exceed the costs of providing additional fire services attributable to new residential or nonresidential construction, including: master planning to more specifically identify capital facilities to serve new development; the acquisition of additional property for fire facilities; the construction of buildings for fire services; the furnishing of buildings or facilities for fire services; and the purchasing of equipment, apparatus, and vehicles for fire services.
- E. The fees collected pursuant to this chapter shall be used to finance the fire facilities, equipment, and apparatus identified in Subsection 18.23.010.D.
- F. Detailed study of the impacts of future residential and nonresidential construction in the City, along with an analysis of the need for new fire facilities and equipment has been prepared. This study is included in the "Public Safety Impact Fee Study" for the City of Long Beach dated August 18, 2006 which is incorporated herein by reference as though set forth in full, word for word.
- G. There is a reasonable relationship between the need for the fire facilities, apparatus and equipment set forth in Subsection 18.23.010.D and the impacts of the types of development for which the corresponding fee is charged.
- H. There is a reasonable relationship between the fee's use and the type of development for which the fee is charged.
- I. There is a reasonable relationship between the amount of the fee and the cost of the facilities, apparatus and equipment or portion thereof attributable to the development on which the fee is imposed.

18.23.020 – Purpose.

A Fire Facilities Impact Fee is imposed on residential and nonresidential development for the purpose of assuring that the impacts created by said development pay its fair share of the costs required to support needed fire facilities and related costs necessary to accommodate such development.

18.23.030 – Definitions.

As used in this chapter:

- A. "Accessory use" is as defined in Section 21.15.060 of this code.

- B. "Applicant" means the property owner, or duly designated agent of the property owner, for which a request for building permit or construction approval for a mobilehome pad is received by the City.
- C. "Building permit" means the City permit required for new building construction and/or additions which add square footage pursuant to Title 18 of this code. Neither a grading permit nor a foundation permit shall be considered a building permit for purposes of this chapter.
- D. "Calculation" means the point in time at which the City calculates the Fire Facilities Impact Fee to be paid by the applicant. Calculation will generally occur at the time of issuance of the applicable building permit or construction approval for a mobilehome pad but may occur earlier in the development approval process.
- E. "City Manager" means the City Manager of the City of Long Beach or other municipal officials he or she may designate to carry out the administration of this chapter.
- F. "Collect" or "collection" means the point in time at which the Fire Facilities Impact Fees are paid by the applicant. Collection will occur on the date of final inspection or the date a Certificate of Occupancy or Temporary Certificate of Occupancy, whichever occurs first, or in the case of a mobilehome pad or pads, collection will occur at or on the date of construction approval is issued.
- G. "Development" means the addition of new dwelling units and/or new nonresidential square footage to an undeveloped, partially developed or redeveloped site and involving the issuance of a building permit and Certificate of Occupancy for such construction, reconstruction or use. Development also includes the approval and construction of new mobilehome pads in existing or new mobilehome parks or sites but not including the following so long as no additional dwelling units or gross floor area is added:
 - 1. A permit to operate;
 - 2. A permit for the internal alteration, remodeling, rehabilitation, or other improvements or modifications to an existing structure;
 - 3. The rebuilding of a structure destroyed by an act of God or the rehabilitation or replacement of a building in order to comply with the City's seismic safety requirements;
 - 4. Parking facilities; or
 - 5. The rehabilitation or replacement of a building destroyed by imminent public hazard, acts of terrorism, sabotage, vandalism, warfare or civil disturbance except where said destruction was caused or in any manner accomplished, instigated, motivated, prompted, incited, induced, influenced, or participated in by any persons or their agents having any interest in the real or personal property at the location.
- H. "Dwelling unit" or "DU" is as defined in Section 21.15.910 of this code.
- I. "Fee-setting resolution" means and refers to the City resolution specifying the Fire Facilities Impact Fee per dwelling unit or mobilehome pad for residential development and per gross square foot of floor area for nonresidential development, by type and by location. The Fire Facilities Impact Fee set forth in the fee-setting resolution may be revised pursuant to Section 18.23.140 and applicable State law.
- J. "Fire Department" means the Fire Department of the City of Long Beach.
- K. "Gross square feet" or "gsf" means the area of a nonresidential development measured from the exterior building lines of each floor with respect to enclosed spaces but excluding parking spaces whether or not enclosed. For purposes of this chapter, the term "enclosed spaces" specifically

includes, but is not limited to, an area available to and customarily used by the general public and all areas of business establishments generally accessible to the public such as fenced or partially fenced in areas of garden centers attached to and serving the primary structure.

- L. "Mixed use" is as defined in Section 21.15.1760 of this code.
- M. "Mobilehome" is as defined in Section 21.15.1770 of this code.
- N. "Nonresidential development" means a development undertaken for the purpose of creating gross floor area, excluding dwelling units, but which includes, and is not limited to, commercial, industrial, retail, office, hotel/motel, and warehouse uses involving the issuance of a building permit for such construction, reconstruction or use.
- O. "Principal use" is as defined in Section 21.15.2170 of this code.
- P. "Residential development" means a development undertaken for the purpose of creating a new dwelling unit or units and involving the issuance of a building permit and Certificate of Occupancy for such construction, reconstruction or use, or the construction approval for a mobilehome pad or pads.

18.23.040 – Fund established.

A Fire Facilities Impact Fee fund is established. The Fire Facilities Impact Fee fund is a fund to be utilized for payment of the actual or estimated costs of fire facilities, apparatus and equipment related to new residential and nonresidential construction as described in this chapter.

18.23.050 – Fire Facilities Impact Fee.

There is imposed a Fire Facilities Impact Fee on all new residential and nonresidential development as those terms are defined in this chapter.

18.23.060 – Fee imposed.

- A. Any person who, after the effective date of the ordinance codified in this chapter, seeks to engage in residential or nonresidential development including mobilehome development as defined in this chapter by obtaining a building permit or construction approval for a mobilehome pad or pads is required to pay a Fire Facilities Impact Fee in the manner and amount as set forth in the then current fee-setting resolution. The Fire Facilities Impact Fee imposed pursuant to this chapter shall not apply to those projects for which a Planning Bureau application for conceptual or site plan review has been filed and deemed complete by the Department of Development Services by April 3, 2007.
- B. No Certificate of Occupancy, Temporary Certificate of Occupancy, final inspection approval or construction approval for a mobilehome pad or pads, as applicable, for the activities listed in subsection A of this section shall be issued unless and until the Fire Facilities Impact Fee required by this chapter has been paid to the City.

18.23.070 – Calculation of Fire Facilities Impact Fee.

- A. The Director shall calculate the amount of the applicable Fire Facilities Impact Fee due as specified in the then current fee-setting resolution.
- B. The Director shall calculate the amount of the applicable Fire Facilities Impact Fee due by:
 - 1. Determining the number and type of dwelling units in a residential development, or mobilehome pads in a mobilehome park or site, and multiplying the same by the Fire

- Facilities Impact Fee amount per dwelling unit or pad as established by the then current fee-setting resolution;
2. Determining the gross square feet of floor area, type of use and location in a nonresidential development, and multiplying the same by the Fire Facilities Impact Fee amount as established by the then current fee-setting resolution;
 3. Determining the number and type of dwelling units and the nonresidential number of gross square feet of floor area, type of use and location, in a structure containing mixed uses which include a residential use, and multiplying the same by the Fire Facilities Impact Fee amount for each use as established by the then current fee-setting resolution;
 4. Determining the gross square feet of floor area, type of use and location in a structure containing mixed uses which include two (2) or more nonresidential principal uses, and multiplying the same by the Fire Facilities Impact Fee amount as established by the then current fee-setting resolution. The gross square feet of floor area of any accessory use will be charged at the same rate as the predominant principal use unless the Director finds that the accessory use is related to another principal use.

18.23.080 – Payment of fee.

- A. The City shall collect from the applicant the Fire Facilities Impact Fee prior to the issuance of a Certificate of Occupancy, Temporary Certificate of Occupancy, final inspection or construction approval for mobilehome pad or pads, whichever occurs first.
- B. Except for an administrative charge that shall be allocated to the Department of Development Services, all funds collected shall be properly identified and promptly transferred for deposit in the Fire Facilities Impact Fee fund and used solely for the purposes specified in this chapter.

18.23.090 – Use of funds.

- A. Funds collected from the Fire Facilities Impact Fee shall be used to fund the costs of providing additional fire services attributable to new residential and nonresidential construction and shall include:
 1. The acquisition of additional property for Fire Department facilities;
 2. The construction of new buildings for Fire Department services;
 3. The furnishing of new buildings or facilities for Fire Department services;
 4. The purchasing of equipment, apparatus, and vehicles for Fire Department services;
 5. The funding of a master plan to identify capital facilities to serve new Fire Department development;
 6. The cost of financing (e.g., interest payments) related to Subsections 1 through 5, inclusive.
- B. Funds shall not be used for periodic or routine maintenance.
- C. In the event that bonds or similar debt instruments are issued for advanced provision of capital facilities for which Fire Facilities Impact Fees may be expended, impact fees may be used to pay debt service on such bonds or similar debt instruments to the extent that the facilities provided are of the type described in Subsection 18.23.090.A.
- D. Funds may be used to provide refunds as described in Section 18.23.100.

18.23.100 – Refund.

- A. Any applicant who has paid a Fire Facilities Impact Fee pursuant to this chapter may apply for a full or partial refund of same, if, within one year after collection of the Fire Facilities Impact Fee the development project has been modified, pursuant to appropriate City ordinances and regulations, resulting in a reduction in the number of dwelling units, a change in the type of dwelling units, a reduction in square footage, or the applicability of an exemption pursuant to Section 18.23.110 of this chapter. The City shall retain a sum equaling twenty percent (20%) of the impact fee paid by the applicant to offset the administrative costs of refund. The applicant must submit an application for such a refund in accordance with Chapter 3.48 of this code. In no event shall a refund exceed the amount of the Fire Facilities Impact Fee actually paid.
- B. Any funds not expended, encumbered or obligated by issued indebtedness by the end of the calendar quarter immediately following five years from the date the Fire Facilities Impact Fee was paid shall, upon application of the then current landowner, be returned to such landowner with interest at a rate equal to the rate of interest earned by the City from the time the fee was paid, provided that the landowner submits an application for a refund within one hundred eighty (180) calendar days from the expiration of the five-year period.

18.23.110 – Exemptions and credits.

- A. Exemptions. Any claim of exemption must be made no later than the time of application for a building permit or mobilehome construction approval. The following shall be exempted from payment of the Fire Facilities Impact Fee:
 - 1. Alterations or expansion of an existing residential building where no additional dwelling units are created and where the use is not changed;
 - 2. The replacement of a building or structure destroyed by fire, flood, earthquake or other act of God, with a new building or structure of the same size and use;
 - 3. The installation of a replacement mobilehome on a lot or other such site when a Fire Facilities Impact Fee for such mobilehome site has previously been paid pursuant to this chapter, or where a mobilehome legally existed on such site on or prior to the effective date of the ordinance codified in this chapter;
 - 4. Nonresidential development. Construction or occupancy of a new nonresidential building or structure or an addition to or expansion of an existing nonresidential building or structure of three thousand (3,000) gross square feet or less;
 - 5. Residential development. Construction, replacement or rebuilding of a single-family dwelling (one unit per lot) on an existing lot of record, or the replacement of one (1) mobilehome with another on the same pad, or the moving and relocation of a single-family home from one (1) lot within the City to another lot within the City, or the legalization of an illegal dwelling unit existing prior to January 1, 1964, for which an administrative use permit is approved in accordance with Section 21.25.403(D). This exemption shall not apply to tract development, to the development of more than one (1) unit per lot nor to the replacement of a single-family dwelling with more than one (1) dwelling unit;
 - 6. Affordable housing for lower income households. Property rented, leased, sold, conveyed or otherwise transferred, at a rental price or purchase price which does not exceed the "affordable housing cost" as defined in Section 50052.5 of the California Health and Safety Code when provided to a "lower income household" as defined in Section 50079.5 of the California Health and Safety Code or "very low-income household" as defined in Section 50105 of the California Health and Safety Code. This exemption shall require the applicant to execute an agreement to guarantee that the units shall be maintained for lower and very low-income households whether as units for rent or for sale or transfer, for the lesser of a period

of thirty (30) years or the actual life or existence of the structure, including any addition, renovation or remodeling thereto. The agreement shall be in the form of a deed restriction or other legally binding and enforceable document acceptable to the City Attorney and shall bind the owner and any successor-in-interest to the real property being developed. The agreement shall subordinate, if required, to any State or federal program providing affordable housing to lower and very low-income households. The agreement shall be recorded with the Los Angeles County Recorder prior to the issuance of a Certificate of Occupancy. The City's Housing and Community Improvement Bureau shall be notified of pending transfers or purchases and give its approval of the purchaser's qualifying income status and purchase price, prior to the close of escrow. The City's Housing and Community Improvement Bureau shall be notified of pending rentals and give its approval of proposed tenant's qualifying income status and rental rate, prior to the tenant's occupancy. Applicant or any successor-in-interest shall be required to provide annually, or as requested, the names of all tenants or purchasers, current rents, and income certification to insure compliance. Voluntary removal of the housing restriction or violation of the restriction shall be enforced by the City's Housing and Community Improvement Bureau and shall require the applicant or any successor-in-interest to pay the then applicable Fire Facilities Impact Fee at the time of voluntary conversion or as imposed at the time of violation on the unit in violation, plus any attorneys' fees and costs of enforcement, if applicable.

7. Hospitals as that term is defined in Section 21.15.1370 of this code.

- B. Credits. Any applicant whose development is located within a Community Facilities District (CFD), and is subject to the assessments thereof, shall receive an offset credit towards the fees established by this chapter to the extent that the assessments fund improvements within the CFD which would otherwise be funded by the development impact fees established by this chapter.

18.23.120 – Appeals.

- A. An applicant may appeal, by protest, any imposition of the Fire Facilities Impact Fee by filing a notice of appeal with the City Clerk within ninety (90) days after the applicant pays the required fee.
- B. A valid appeal by protest of the imposition of the Fire Facilities Impact Fee shall meet all of the following requirements:
1. Tendering in advance of the appeal any required payment in full or providing assurance of payment satisfactory to the City Attorney;
 2. Serving written notice on the City including:
 - a. A statement that the required payment has been tendered under protest or that required conditions have been satisfied;
 - b. A statement informing the City of the factual elements of the dispute and the legal theory forming the basis of the protest;
 - c. The name and address of the applicant;
 - d. The name and address of the property owner;
 - e. A description and location of the property;
 - f. The number of residential units or nonresidential gross square footage proposed, by land use or dwelling unit type, as appropriate; and
 - g. The date of issuance of the building permit.

- C. The City Council shall schedule a hearing and render a final decision on the applicant's appeal within sixty (60) days after the date the applicant files a valid appeal.
- D. The City Council hearing shall be administrative. Evidence shall be submitted by the City and by the applicant and testimony shall be taken under oath.
- E. The burden of proof shall be on the applicant to establish that the applicant is not subject to the imposition of the Fire Facilities Impact Fee pursuant to the express terms of this chapter and applicable State law.
- F. If the Fire Facilities Impact Fee has been paid in full or if the notice of appeal is accompanied by a cash deposit, letter of credit, bond or other surety acceptable to the City Attorney in an amount equal to the Fire Facilities Impact Fee calculated to be due, the application for the building permit or mobilehome construction approval shall be processed. The filing of a notice of appeal shall not stay the imposition or the collection of the Fire Facilities Impact Fee calculated by the City to be due unless sufficient and acceptable surety has been provided.
- G. Any petition for judicial review of the City Council's final decision shall be made in accordance with applicable State law and pursuant to Section 18.23.130.

18.23.130 – Judicial review.

- A. Any judicial action or proceeding to attack, review, set aside, void or annul the ordinance codified in this chapter, or any provision thereof, or resolution, or amendment thereto, shall be commenced within ninety (90) days of the effective date of the ordinance codified in this chapter, resolution, or any amendment thereto.
- B. Any judicial action or proceeding to attack, review, set aside or annul the imposition or collection of a Fire Facilities Impact Fee on a development shall be preceded by a valid appeal by protest pursuant to Section 18.23.120 hereof and a final decision of the City Council pursuant thereto and shall be filed and service of process effected within ninety (90) days after the hearing on appeal regarding the imposition of a Fire Facilities Impact Fee upon the development.

18.23.140 – Annual report and amendment procedures.

- A. Within one hundred eighty (180) days after the last day of each fiscal year, the Fire Chief of the City of Long Beach shall evaluate progress in implementation of the Fire Facilities Impact Fee program and shall prepare a report thereon to the City Council in accordance with Government Code Section 66006 incorporating among other things:
 - 1. The fire facilities, apparatus, and equipment commenced, purchased or completed utilizing monies from the Fire Facilities Impact Fee fund;
 - 2. The amount of the fees collected and the interest earned;
 - 3. The amount of Fire Facilities Impact Fees in the fund; and
 - 4. Recommended changes to the Fire Facilities Impact Fee, including, but not necessarily limited to, changes in the Fire Facilities Impact Fee chapter or fee-setting resolution.
- B. Based upon the report and such other factors as the City Council deems relevant and applicable, the City Council may amend the ordinance codified in this chapter or the fee-setting resolution implementing this chapter. Changes to the Fire Facilities Impact Fee rates or schedules may be made by amending the fee-setting resolution. Any change which increases the amount of the Fire Facilities Impact Fee shall be adopted by the City Council only after a noticed public hearing. Nothing herein precludes the City Council or limits its discretion to amend the ordinance codified

in this chapter or the fee-setting resolution establishing Fire Facilities Impact Fee rates or schedules at such other times as may be deemed necessary.

18.23.150 – Effect of Fire Facilities Impact Fee on zoning and subdivision regulations.

This chapter shall not affect, in any manner, the permissible use of property, density/intensity of development, design and improvement standards and public improvement requirements or any other aspect of the development of land or construction of buildings, which may be imposed by the City pursuant to the City's zoning regulations, subdivision regulations or other ordinances or regulations of the City, which shall be operative and remain in full force and effect without limitation with respect to all residential and nonresidential development.

18.23.160 – Violation—Penalty.

A violation of this chapter shall be prosecuted in the same manner as misdemeanors are prosecuted; and upon conviction, the violator shall be punishable according to law. However, in addition to or in lieu of any criminal prosecution, the City shall have the power to sue in civil court to enforce the provisions of this chapter.

18.23.170 – Severability.

If any section, phrase, sentence, or portion of this chapter is for any reason held invalid or unconstitutional by any court of competent jurisdiction, such portions shall be deemed a separate, distinct, and independent provision; and such holding shall not affect the validity of the remaining portions thereof.

CHAPTER 18.24 FORECLOSURE REGISTRY PROGRAM

18.24.010 – Purpose.

18.24.020 – Definitions.

18.24.030 – Registration.

18.24.035 – Penalty/fine for failure to timely register a property with the City.

18.24.040 – Maintenance required.

18.24.050 – Security requirements.

18.24.055 – Special provisions where property is encumbered with the security interests of multiple beneficiaries.

18.24.060 – Additional authority.

18.24.070 – Enforcement.

18.24.080 – Appeals.

18.24.090 – Alternative monetary penalties.

18.24.100 – Severability.

CHAPTER 18.24 FORECLOSURE REGISTRY PROGRAM

18.24.010 – Purpose.

It is the intent of the City Council, through the adoption of this chapter, to establish a mechanism to protect residential neighborhoods from becoming blighted through the lack of adequate maintenance and security of vacant, abandoned or foreclosed upon residential real properties; to establish a vacant, abandoned or foreclosed upon residential property registration program and to set forth guidelines for the maintenance of vacant, abandoned or foreclosed upon residential real properties.

18.24.020 – Definitions.

Certain words and phrases in this chapter are defined, when used herein, as follows:

Abandoned. Any residential building, structure or real property that is vacant or occupied by a person without a legal right of occupancy, and subject to a current Notice of Default and/or Notice of Trustee's Sale, pending Tax Assessor's Lien Sale and/or any residential real property conveyed via a foreclosure sale resulting in the acquisition of Title by an interested beneficiary of a deed of trust, and/or any residential real property conveyed via a deed in lieu of foreclosure sale.

Accessible Property. Residential real property that is accessible to the public, either in general, or through an open and unsecured door, window, gate, fence, wall, or the like.

Agreement. Any written instrument that transfers or conveys Title to residential real property from one owner to another after a sale, trade, transfer or exchange.

Assignment of Rents. An instrument that transfers the beneficial interest under a deed of trust from one lender or entity to another.

Beneficiary. A lender participating in a residential real property transaction that holds a secured interest in the residential real property in question identified in a deed of trust.

Buyer. Any person, partnership, association, corporation, fiduciary or other legal entity that agrees to transfer anything of value in consideration for residential real property via an "agreement" as that term is defined in this Section.

Dangerous Building. Any residential building or structure reasonably deemed by qualified City staff to represent a violation of any provision specified in Section 18.02.050.

Days. Calendar days.

Deed of Trust. An instrument whereby an owner of residential real property, as trustor, transfers a secured interest in the real property in question to a third party trustee, said instrument relating to a loan issued in the context of a real property transaction. This definition applies to any and all subordinate deeds of trusts including, but not limited to a second trust deed or third trust deed.

Deed in Lieu of Foreclosure. A recorded instrument that transfers ownership of real property between parties to a particular deed of trust as follows - from the trustor (i.e., borrower), to the trustee upon consent of the beneficiary (i.e., lender).

Default. The material breach of a legal or contractual duty arising from or relating to a deed of trust, such as a trustor's failure to make payment when due.

Distressed. Any residential building, structure or real property that is subject to a current Notice of Default and/or Notice of Trustee's Sale, pending Tax Assessors Lien Sale and/or any residential real property conveyed via a foreclosure sale resulting in the acquisition of Title by an interested

beneficiary of a deed of trust, and/or any residential real property conveyed via a deed in lieu of foreclosure/sale, regardless of vacancy or occupancy by a person with no legal right of occupancy.

Enforcement Official. The City Manager, the Director of Development Services, and/or any employee or agency of the City of Long Beach designated and/or charged with enforcing the Long Beach Municipal Code, including but not limited to, applicable codes adopted by reference therein.

Evidence of Vacancy. Any residential real property condition that independently, or in the context of the totality of circumstances relevant to that real property, would lead a reasonable enforcement official to believe that a property is vacant or occupied by a person without a legal right of occupancy. Such real property conditions include, but are not limited to: overgrown or dead vegetation; accumulation of newspapers, circulars, flyers or mail; past due utility notices or disconnected utilities; accumulation of trash, junk or debris; the absence of window coverings such as curtains, blinds or shutters; the absence of furnishings or personal items consistent with residential habitation; and/or statements by neighbors, passersby, delivery agents, or government employees that the property is vacant.

Foreclosure. The process by which real property subject to a deed of trust is sold to satisfy the debt of a defaulting trustor (i.e., borrower).

Local. Within forty (40) road or driving miles distance from the subject building, structure or real property in question.

Neighborhood Standard. The condition of residential real property that prevails in and through the neighborhood where an abandoned building, structure or real property is located. When determining the neighborhood standard no abandoned or distressed building, structure or real property shall be considered.

Notice of Default. A recorded instrument that reflects and provides notice that a default has taken place with respect to a deed of trust, and that a beneficiary intends to proceed with a trustee's sale.

Out of Area. In excess of forty (40) road or driving miles of the subject property.

Owner. Any person, partnership, association, corporation, fiduciary or other legal entity having recorded Title to the property as reflected in the official records of the County Recorder of Los Angeles County.

Owner of Record. The person holding recorded Title to the residential real property in question at any point in time when Official Records are produced by the Los Angeles County Registrar/Recorder's office.

Property. Any unimproved or improved residential real property, or portion thereof, situated in the City of Long Beach, including buildings or structures located on said real property, regardless of condition.

Residential Building. Any improved real property, or portion thereof, designed or permitted to be used for dwelling purposes, including buildings and structures located on such improved real property. This includes any real property being offered under any circumstances for sale, trade, transfer, or exchange as "residential," whether or not said property is legally permitted and zoned for such use.

Securing. Such measures as may be directed by a code enforcement official that assist in rendering real property inaccessible to unauthorized persons, including but not limited to repairing fences and walls, chaining/padlocking gates, the repairing or boarding of doors, windows or other such openings.

Trustee. Any person, partnership, association, corporation, fiduciary or other legal entity holding a deed of trust securing an interest in real property.

Trustor. Any owner/borrower identified in a deed of trust, who transfers an interest in real property to a trustee as security for payment of a debt by that owner/trustor.

Vacant. Any building, structure or real property that is unoccupied or occupied by a person without a legal right of occupancy.

18.24.030 – Registration.

- A. Not later than ten (10) days after recording a notice of default on any residential property located in the City of Long Beach which is subject to a deed of trust, the beneficiary, or its trustee, shall register the property with the Development Services Department of the City of Long Beach on forms provided by the City.
- B. The registration pursuant to this Section shall be renewed annually until such time as:
 - 1. The foreclosure process is complete or the notice of default has been rescinded or withdrawn;
 - 2. The Trustor has surrendered the property to the beneficiary as evidenced by either a letter from the trustor addressed to the beneficiary confirming such surrender, or by the trustor's delivery of the keys to the property to the beneficiary or its agent.
 - 3. The beneficiary has obtained possession of the property under Section 1161 or 1161a or 1161b of the Code of Civil Procedure, as applicable, following completion of the foreclosure proceeding.

If a subsequent notice of default is issued for the same property after being withdrawn or rescinded, the registration requirement set forth in this Section shall be reinstated.

- C. The registration pursuant to this Section shall contain the identity of the beneficiary and trustee, the direct mailing address of the beneficiary and trustee and, in the case of a corporate or out of area beneficiary or trustee, the local property management company, if any, responsible for the security, maintenance and marketing of the property in question.
- D. An annual registration fee as set by the City Council by resolution shall accompany the submission of each registration form. The fee and registration shall be valid for one (1) year from the date of registration. Registration fees will not be prorated. Subsequent registrations and fees are due January 1st of each year and must be received no later than January 15th of the year due.
- E. Any person, partnership, association, corporation, fiduciary or other legal entity that has registered a property under this chapter must make a written report to the City of Long Beach Development Services Department of any change of information contained in the registration form within ten (10) days of the change.
- F. The duties/obligations specified in this chapter shall be joint and several among and between all trustees and beneficiaries and their respective agents.

18.24.035 – Penalty/fine for failure to timely register a property with the City.

- A. Notwithstanding any other provision of this chapter or Chapter 9.65 to the contrary, the City may, after fifteen (15) days written notice to the beneficiary or its trustee, impose a fine/penalty on a beneficiary or its trustee for its failure to timely register a property with the City under this chapter. The amount of such fines and/or penalties shall be established by the City Council by resolution.

- B. The imposition of a fine/penalty for failure to register a property shall be in accordance with the provisions and procedures set forth in Chapter 9.65 of the Long Beach Municipal Code: "Administrative Citations and Penalties."
- C. Any failure to pay fines or penalties imposed pursuant to this chapter may be remedied by the City in accordance with Section 9.65.140, or any successor section thereto.

18.24.040 - Maintenance required.

It is declared a public nuisance for any person, partnership, association, corporation, fiduciary or other legal entity, that owns, leases, occupies, controls or manages any property subject to the registration requirement contained in Section 18.24.030, to cause, permit, or maintain any property condition contrary to any provision of this chapter. Consequently, the following maintenance requirements as to any property subject to the registration requirement contained in Section 18.24.030 are adopted:

- A. Any property subject to this chapter must comply with the requirements of the Long Beach Municipal Code Chapter 18.20 entitled "Unsafe Buildings or Structures."
- B. In addition, the property shall be kept free of weeds, dry brush, dead vegetation, trash, junk, debris, building materials, any accumulation of newspaper, circular, flyers, notices (except those required by federal, State or local law), discarded personal items including, but not limited to, furniture, clothing, large and small appliances, printed material or any other items that give the appearance that the property is abandoned.
- C. The property shall be maintained free of graffiti, tagging or similar marking. Any removal or painting over of graffiti shall be with an exterior grade paint that matches the color of the exterior of the structure.
- D. Visible front and side yards shall be landscaped and maintained to the neighborhood standard.
- E. Landscaping includes, but is not limited to, grass, ground covers, bushes, shrubs, hedges or similar plantings, decorative rock or bark or artificial turf/sod designed specifically for residential installation.
- F. Landscaping does not include weeds, gravel, broken concrete, asphalt, plastic sheeting, mulch, indoor-outdoor carpet or any other similar material.
- G. Pools and spas shall be kept in working order so that water remains clear and free of pollutants and debris, or alternatively shall be drained and kept dry. In either case, properties with pools and/or spas must comply with the minimum security fencing requirements of the State of California.
- H. Adherence to this section does not relieve the beneficiary/trustee or property owner of obligations set forth in any portion of the Long Beach Municipal Code or in any Covenants, Conditions and Restrictions and/or Home Owners Association rules and regulations which may apply to the property.

The sole exception to these maintenance requirements shall, within the sole reasonable discretion of the Director of Development Services or designee, apply to property subject to the registration requirement contained in Section 18.24.030 that is under construction and/or repair, not less than three (3) business days per week, undertaken in compliance with all applicable laws, including but not limited to, City permitting requirements.

18.24.050 – Security requirements.

- A. Properties subject to this chapter shall be maintained in a secure manner so as not to be accessible to unauthorized persons.
- B. Secure manner includes, but is not limited to, closing and locking of windows, doors (walk-through, sliding, and garage), gates and any other opening that may allow access to the interior of the property and/or structure(s). In the case of broken windows, "securing" means reglazing or boarding the window.
- C. If the property is owned by a corporation and/or out of area beneficiary/trustee/owner, a local property management company shall be contracted to perform weekly inspections to verify that the requirements of this Section, and any other applicable laws, are being fulfilled.
- D. The property shall be posted with the name and twenty-four (24) hour contact phone number of the local property management company. The posting shall be 8-½" x 11" in size, shall be of a font that is legible from a distance of twenty (20) feet, and shall contain the following verbiage: "THIS PROPERTY MANAGED BY _____," and "TO REPORT PROBLEMS OR CONCERNS CALL (name and phone number)."
- E. The posting shall be placed on the interior of a window facing the street to the front of the property so it is visible from the street, or secured to the exterior of the building/structure facing the street on the front of the property so it is visible from the street. If no such area exists, the posting shall be on a stake of sufficient size to support the posting, in a location that is visible from the street to the front of the property, and to the extent possible, not readily accessible to potential vandalism. Exterior posting must be constructed of, and printed with weather resistant materials.
- F. The local property management company shall inspect the property on a weekly basis to determine if the property is in compliance with the requirement of this chapter. If the property management company determines the property is not in compliance, it is the company's responsibility to bring the property into compliance.
- G. The duties/obligations specified in this chapter shall be joint and several among and between all trustees and beneficiaries and their respective agents.

18.24.055 – Special provisions where property is encumbered with the security interests of multiple beneficiaries.

- A. In the event that a property is encumbered by the security interests of more than one (1) beneficiary at the time when a notice of default is recorded, the beneficiary who causes a notice of default for its security interest to be recorded shall be responsible for registering the property with the City as provided in Section 18.24.030
- B. Upon the recordation of a notice of default on a property by any beneficiary, regardless of the security lien interest priority of such beneficiary in the property in relation to the priority of the security interests of the other beneficiaries in the same property, the City, in its discretion may elect to enforce the provisions of this chapter against one or more beneficiaries who have not separately recorded a notice of default against the property.

18.24.060 - Additional authority.

In addition to the enforcement remedies established in this chapter, the City shall have the authority to require the beneficiary, trustee, owner or owner of record of any property affected by this chapter, to implement additional maintenance and/or security measures including, but not limited to, securing any and all doors, windows or other openings, installing additional security lighting, increasing on-site inspection frequency, employment of an on-site security guard and/or other measures as may be reasonably required to secure and reduce the visual decline of the property.

18.24.070 - Enforcement.

- A. Any violation of this chapter shall be treated as a strict liability offense; a violation shall be deemed to have occurred regardless of a violator's intent. Any person, firm and/or corporation that violates any portion of this chapter including, but not limited to the registration requirements set forth in Section 18.24.030, the maintenance requirements set forth in Section 18.24.040, and the security requirements set forth in Section 18.24.050 may be subject to administrative enforcement under Chapter 9.65 of the Long Beach Municipal Code. Administrative penalties imposed pursuant to this chapter shall not exceed one hundred thousand dollars (\$100,000.00) per property.
- B. Any person, partnership, association, corporation, fiduciary or other legal entity, that owns, leases, occupies, controls or manages any property subject to the registration requirement contained in Section 18.24.030, and causes, permits, or maintains a violation of this chapter as to that property, shall be guilty of a misdemeanor, and upon conviction thereof, shall be punished as provided in Chapter 1.32 of the Long Beach Municipal Code.
- C. This chapter is intended to be cumulative to, and not in place of, other rights and remedies available to the City pursuant to the Long Beach Municipal Code. The City Attorney or a duly authorized enforcement official may pursue any other right or remedy permitted by the Long Beach Municipal Code, including, but not limited to, commencement of any civil action, or administrative action to abate the condition of a property as a public nuisance.

18.24.080 – Appeals.

If an administrative citation has been issued pursuant to the provisions of Chapter 9.65 of the Long Beach Municipal Code, then the procedures set forth in Chapter 9.65 shall govern.

18.24.090 – Alternative monetary penalties.

- A. This section is intended to carry out the provisions of Section 2929.3 of the California Civil Code. Nothing in this section shall be interpreted or implemented in a manner that is inconsistent with State law. If there is a conflict between the provisions of State law and this section, State law shall control.
- B. The City may elect to impose monetary penalties on a legal owner, pursuant to Section 2929.3 of the California Civil Code, if that legal owner fails to maintain vacant residential property that is either purchased at a foreclosure sale or acquired through foreclosure under a mortgage or deed of trust.

For purposes of this section, "fails to maintain" means failing to care for the exterior of the property, including, but not limited to, permitting excess foliage growth that diminishes the value of surrounding properties, failing to take action to prevent trespassers, squatters or other unauthorized persons from remaining on the property, or failing to take action to prevent mosquito larvae from growing in standing water, or other conditions that create a public nuisance.

- C. The City may impose a fine of up to one thousand dollars (\$1,000.00) per day for each day that the legal owner fails to maintain the property as required by this section, commencing on the day following the expiration of the period to remedy the violation, as established by the City in Subsection D.
 - 1. In determining the amount of the fine, the City shall take into consideration any timely and good faith efforts by the legal owner to remedy the violation.
 - 2. Fines and penalties collected pursuant to this section shall be directed toward local nuisance abatement programs.

3. Pursuant to Section 2929.3 of the California Civil Code, the City may not impose fines on a legal owner under both this Section and any other local ordinance. However, Section 2929.3 of the California Civil Code shall not preempt any local ordinance.
 4. Notwithstanding Subsection C.3, the rights and remedies provided in this section are cumulative and in addition to any other rights and remedies provided by law.
- D. If the City imposes a fine pursuant to this section, the City shall give notice of the alleged violation to the legal owner. The notice shall include a description of the conditions that gave rise to the alleged violation, and state the City's intent to assess a civil fine if action to correct the violation is not commenced within a period of not less than fourteen (14) days and completed within a period of not less than thirty (30) days.
1. The notice shall be mailed to the address provided in the deed or other instrument as specified in subdivision (a) of Section 27321.5 of the California Government Code, or, if none, to the return address provided on the deed or other instrument.
 2. The City may provide less than thirty (30) days' notice to remedy a condition, if the City determines that a specific condition of the property threatens public health or safety and the notice of violation states that there is a threat to public health or safety and lists the required time to correct the violation.

18.24.100 – Severability.

If any section or provision of this chapter is for any reason held to be invalid or unconstitutional by any court of competent jurisdiction, or contravened by reason of any preemptive legislation, the remaining sections and/or provisions of this chapter shall remain valid. The City Council hereby declares that it would have adopted this chapter, and each section or provision thereof, regardless of the fact that any one or more section(s) or provision(s) may be declared invalid or unconstitutional or contravened via legislation.

CHAPTER 18.25 TENANT RELOCATION AND CODE ENFORCEMENT

- 18.25.010 – Purpose.
- 18.25.020 – Findings.
- 18.25.030 – Definitions.
- 18.25.040 – Eligibility.
- 18.25.050 – Order to vacate.
- 18.25.060 – Notification of tenants and owners.
- 18.25.070 – Issuance of permits.
- 18.25.080 – Payment of relocation benefits.
- 18.25.090 – Relocation eligibility and assistance by City.
- 18.25.100 – Immediate vacation.
- 18.25.110 – Amount of relocation payments.
- 18.25.120 – Evictions to avoid payment of relocation assistance.
- 18.25.130 – Move-back option.
- 18.25.140 – Certificate of occupancy.
- 18.25.150 – Appeals.
- 18.25.160 – Penalty.
- 18.25.170 – Private right of action.
- 18.25.180 – Application to heirs.
- 18.25.190 – Relationship to other laws.
- 18.25.200 – Penalty fund.
- 18.25.210 – Severability.

CHAPTER 18.25 TENANT RELOCATION AND CODE ENFORCEMENT

18.25.010 – Purpose.

The primary purpose of this chapter is to provide for owner-paid relocation payments and assistance to residential tenants who are displaced due to the City of Long Beach's code enforcement activities.

18.25.020 – Findings.

This chapter is enacted in recognition of the following facts and for the following reasons:

- A. Some residential rental units in the City have been found to have severe code violations that threaten the life and safety of occupants. In some circumstances, the hazardous living conditions have required that tenants vacate the structure to allow for extensive repairs or demolition.
- B. These code violations often are caused by negligence, deferred maintenance, or the illegal use of certain structures as dwelling units. These code violations typically constitute a violation of the owner's legal responsibility to the tenants. For example, they may be a breach of the owner's implied warranty of habitability, and could constitute constructive eviction of the tenants from their residence.
- C. The difficulty of finding affordable replacement housing and the burden of incurring moving-related expenses creates a financial hardship for tenants, particularly those who are low income. Financial hardship arises because the tenants generally need a large sum of money to relocate, often including first month's rent, security deposits, moving and storage expenses, and utility deposits. Low income tenants are generally unable to obtain the sums needed to relocate and, as a result, are at an increased risk of becoming homeless.
- D. Relocation assistance is necessary to ensure that displaced tenants secure safe, sanitary and decent replacement housing in a timely manner. The level of payments provided for in this chapter are reflective of actual relocation costs likely to be incurred by displaced households. This is consistent with and in furtherance of the housing element of the City's General Plan.
- E. In the past, affected tenants have turned to local, State and national governmental entities for financial assistance in obtaining replacement housing. However, the resources available to such entities to assist displaced tenants have become increasingly scarce.
- F. It is fair for property owners who fail to properly maintain residential rental properties, or who create illegal residential units, to bear responsibility for the hardship their actions or inaction create for tenants. Relocation of tenants is a necessary element of code enforcement that should be the responsibility of the property owner, and the City should be reimbursed by the responsible owner for all costs which the City incurs in the code enforcement process.
- G. Delayed payment of relocation assistance often imposes extreme hardship upon tenants who must obtain the large sums necessary to relocate. Delayed payments may also require the City to expend funds to provide tenants with financial assistance for relocation. Any requirement to pay relocation assistance should contain disincentives for delayed payment in the form of appropriate penalties.
- H. It is the intent of this chapter to ensure that adequate relocation assistance is available to tenants who face displacement through no fault of their own. It is also the intent to provide assistance in a manner that is as equitable as possible to the tenant, the property owner, and the public at large. The requirement for owners to pay relocation costs under this chapter will facilitate the correction of code violations and will likewise protect the public health, safety, and general welfare of the residents of the City.

- I. This chapter is in the public interest for the reasons stated above. Additionally, it furthers the public interest by helping to remove a potential impediment to code enforcement. The City finds that this chapter also is fair, in that it imposes reasonable costs and penalties on owners who operate contrary to the code enforcement regulations of the City.

18.25.030 – Definitions.

For purposes of this chapter, certain terms, phrases, words and their derivatives shall be construed as specified in this Section.

- A. "City Manager" means the City Manager of the City of Long Beach, or his or her designee.
- B. "Code enforcement activity" means activity initiated by the City to determine the condition of a building or structure and which requires the property owner to make necessary repairs, to vacate the building, to demolish the structure or structures, or to take other action to bring the property into compliance with applicable State or local zoning, building, fire, health or housing standards regulations.
- C. "Comparable replacement dwelling" shall have the same meaning as that specified in Section 7260 et seq. of the California Government Code, or any successor statute thereto.
- D. "Day" means calendar day.
- E. "Displacement" means the removal of the tenant household from the property due to the issuance of an order to vacate pursuant to Section 18.20.140.
- F. "Department of Development Services" means the Department of Development Services of the City of Long Beach.
- G. "Notice of intent to order building vacated" means an official notice issued by the City in accordance with Section 18.20.120.
- H. "Order to vacate" means an official notice issued by the City in accordance with Section 18.20.140.
- I. "Property owner" means a person, corporation, or any other entity holding fee title to the subject real property.
- J. "Relocation" means the required vacating of a residential rental unit or room by a tenant or household to further the City's code enforcement activity.
- K. "Rental unit" means a dwelling space containing a separate bathroom, kitchen, and living area, including a single-family dwelling or unit in a multifamily or multipurpose dwelling; or, it means a unit in a condominium or cooperative housing project, which is hired, rented, or leased to a tenant or household within the meaning of Section 1940 of the California Civil Code.
- L. "Room" means an unsubdivided portion of the interior of a building including, but not limited to, illegally converted garage spaces, which are used for the purpose of sleeping, and which are occupied by a tenant for at least thirty (30) consecutive days as determined by the Department of Development Services.
- M. "Substandard building" means and includes every building or other structure as defined in Section 18.02.200. For the purposes of this chapter, substandard building or structure shall mean only those buildings that contain rental units or rooms as defined herein.
- N. "Tenant household" means one (1) or more individuals who: (1) have a landlord-tenant relationship with the property owner, by renting or leasing a rental unit or room in a substandard

building; and (2) can demonstrate a landlord-tenant relationship by leases, cancelled rent checks, rent receipts, utility bills, phone bills, or any other evidence of renting or leasing the premises as determined by the Department of Development Services.

- O. "Long Beach Municipal Code" means all ordinances, rules, and regulations of the City of Long Beach regulating maintenance, sanitation, ventilation, light, location, use or occupancy of residential buildings.

18.25.040 – Eligibility.

A tenant household shall be eligible for consideration for relocation assistance under this chapter when tenants in the household are displaced from their rental units or rooms because of the issuance of a "notice of intent to order building vacated" or an "order to vacate" in accordance with Sections 18.20.120 or 18.20.140, or an order of immediate vacation when the structure or premises has been declared "dangerous" in accordance with Section 18.20.210, or their respective successor sections.

18.25.050 – Order to vacate.

As part of the City's code enforcement activity, the Building Official will decide whether repairs or other actions to abate substandard buildings can be reasonably accomplished without relocation of the tenant or household.

If relocation is necessary to abate a substandard building or condition, the Building Official shall issue and serve an "order to vacate" in accordance with Sections 18.20.140 through 18.20.170.

18.25.060 – Notification of tenants and owners.

- A. When the Building Official issues a notice of substandard building, notice of intent to order building vacated or an order to vacate in accordance with Sections 18.20.120 or 18.20.140, the Building Official shall notify the Department of Development Services of the issuance of the orders and the Department of Development Services shall inform the tenant households in writing of the procedure to apply for relocation assistance, what the tenant household's rights are, and who to contact with questions regarding relocation assistance. The Department of Development Services shall also inform the tenant household that the household may request payment of relocation assistance from the City in accordance with Section 18.25.090, if the owner fails, neglects, or refuses to make the required relocation payments in accordance with this chapter. Relocation assistance information shall be provided to tenant households in English, Spanish, Korean and Khmer to insure the information is accessible to limited English proficiency persons.
- B. The Department of Development Services shall also inform the property owner that failure to make required relocation payments within ten (10) days of notice may result in the City making payments on behalf of the owner, and that failure to reimburse the City for all payments made and other costs and penalties incurred shall result in a lien being placed on the owner's property.
- C. The issuance of an order to vacate shall not relieve the property owner of any legal obligations, including any obligation to provide any notice imposed by any provisions of federal, State, or local laws or ordinances.
- D. At the time a notice of substandard building is issued in accordance with Section 18.20.120, the City shall also notify the property owner of the obligation to pay tenant relocation if required repairs are not made within the time specified in the notice of substandard building.

18.25.070 – Issuance of permits.

If an order to vacate is issued, the City shall require the property owner or the owner's authorized agent to obtain building permits to convert, repair, rehabilitate or demolish the dwelling units that are in violation of the building code in the Long Beach Municipal Code.

18.25.080 – Payment of relocation benefits.

- A. The relocation benefits required by this chapter shall be paid by the owner or designated agent to the tenant household in the form of a certified check, cashier's check, or money order, within ten (10) days after the order to vacate is issued and served in accordance with Section 18.20.160. Proof of such payment shall be made to the Department of Development Services. The tenant household shall not be required by the property owner to vacate the premises until relocation payment is made to the tenant and proof thereof is made to the Department of Development Services, unless the building, fire or health official determines that the building or structure is a dangerous building within the meaning of Section 18.02.050 or other applicable codes. The property owner shall also be responsible for reimbursing the City for any relocation payments the City makes or costs the City incurs under this chapter.
- B. If the building, fire or health official determines that the unit or room is dangerous and must be vacated in less than ten (10) days, then the owner shall make required relocation payments to the tenant household in the form of a certified check, cashier's check, or money order, within two (2) business days after the order to vacate is issued and served in accordance with Section 18.20.160. Proof of the payment shall be made to the Department of Development Services.
- C. No relocation benefits pursuant to this chapter shall be payable to any tenant who has caused or substantially contributed to the condition or conditions giving rise to the order to vacate, as determined by the Department of Development Services, nor shall relocation benefits be payable to a tenant if any guest or invitee of the tenant has caused or substantially contributed to the condition giving rise to the order to vacate, as determined by the Department of Development Services. The Department of Development Services shall make the determination whether a tenant, tenant's guest, or invitee, caused or substantially contributed to the condition giving rise to the order to vacate. Service of a three (3) day notice, notice to terminate or unlawful detainer complaint shall not in and of itself render a tenant household ineligible for relocation benefits under this chapter.
- D. An owner shall not be liable for relocation benefits if the Building Official determines that the building or structure became substandard or dangerous as the result of a fire, flood, earthquake, or other act of God beyond the control of the owner and the owner did not cause or contribute to the condition.
- E. Delay in Payment of Relocation Assistance by Owner. If the owner fails, neglects, or refuses to pay relocation assistance to a displaced tenant, or a tenant subject to displacement, in accordance with this chapter, the City shall also be entitled to recover from the owner an additional amount equal to the sum of one-half ($\frac{1}{2}$) the amount so paid or due, but not to exceed ten thousand dollars (\$10,000.00) cumulative per property, as a penalty for failure to make timely payment to the displaced tenant, plus the City's actual costs, including direct and indirect costs of administering the provisions of assistance to the displaced tenant or tenants.

18.25.090 – Relocation eligibility and assistance by City.

- A. The City may assist tenants displaced or to be displaced due to code enforcement activity subject to this chapter by providing information, referral, monitoring, or other advisory assistance. Any tenant household interested in City assistance should contact the Department of Development Services for relocation information. Failure by tenant households to contact the Department of Development Services shall not relieve property owners from their responsibility to provide relocation assistance.
- B. Tenant households shall submit requests for relocation assistance to the Department of Development Services in order to establish the existence of a landlord-tenant relationship. The Department of Development Services shall make a determination as to whether a tenant household is eligible for relocation assistance within three (3) business days of receipt of a

completed request for relocation assistance. If the Building Official has determined that the tenant household must vacate its unit or room in less than ten (10) days, the Department of Development Services shall make a determination as to whether the tenant household is eligible for relocation assistance within two (2) business days of receiving a completed request for relocation assistance. Once an eligibility determination has been made, the Department of Development Services shall immediately provide written notice in English, Spanish, Korean and Khmer to the tenant household, the owner, and the Building Official regarding the eligibility determination and any relocation assistance owed.

- C. If the owner fails, neglects or refuses to pay relocation assistance to a displaced tenant or a tenant subject to displacement, the City may advance all or a portion of the required payments to the tenant. If the City advances relocation assistance, or a portion thereof, the City shall be entitled to recover from the owner any amount so paid to a tenant pursuant to this Section, and the Department of Development Services shall notify the owner of the City's advancement of payment.

For the City to consider such payments, the tenant household must make a request to the Department of Development Services after the owner fails, neglects or refuses to make such required payments.

- D. Any amount paid by the City on behalf of the owner and any applicable penalties and actual costs including incidental enforcement costs shall become delinquent thirty (30) days after notice by the City and may also be placed as a lien against the property of the owner by recording the lien in the office of the County Recorder for Los Angeles County. Any delinquent payments will accrue interest at the rate of twelve percent (12%) per year until paid.
- E. The failure of the owner to pay the amounts to the City set forth in this chapter within the time specified constitutes a debt to the City. To enforce that debt, the City Manager or his or her designee may take any and all appropriate legal action, impose a lien as set forth above, or pursue any other legal remedy to collect such money.

18.25.100 – Immediate vacation.

If the Building Official determines that the building is dangerous and immediate vacation is required, immediate City payment of relocation benefits can be made to tenant households as soon as the tenant household is determined eligible by the Department of Development Services. The tenant household must sign a request for relocation assistance from the Department of Development Services in order to receive immediate relocation payments. Those payments and other related costs shall be a charge against the property owner, and the owner shall reimburse the City for these relocation costs. Additionally, those costs may be collected, if need be, as outlined in Section 18.25.090. The payment of relocation assistance by the City shall be solely predicated upon the availability of City funds.

18.25.110 – Amount of relocation payments.

Each eligible tenant household shall receive monetary relocation assistance in the amount of three thousand three hundred sixty-six dollars (\$3,366.00). Each eligible household with a disabled person displaced under this chapter shall also be entitled to reimbursement for structural modifications to the household paid for by the tenant household at the vacated premises up to a maximum value of an additional two thousand five hundred dollars (\$2,500.00). The Department of Development Services shall increase both of these amounts on a percentage basis as determined by the change in the Consumer Price Index between January 1, 2005 and January 1 of the year in which the application for relocation assistance is filed with the Department of Development Services.

18.25.120 – Evictions to avoid payment of relocation assistance.

Owners shall not evict tenants to avoid their responsibility to pay relocation assistance to tenants under this chapter. Tenants receiving notices to terminate or quit from the property owner or owner's agent within ninety (90) days of a notice of substandard building shall be presumed eligible and entitled to collect relocation assistance pursuant to this chapter. However, this presumption may be rebutted upon a showing by the owner that the tenant has caused or substantially contributed to the condition or conditions giving rise to the order to vacate.

18.25.130 – Move-back option.

A displaced tenant household shall have the option of moving back into the rental unit or room from which it was required to move provided that such rental room or unit was a legally permitted rental room or unit at the time of displacement. If this is not possible, the displaced tenant household shall have the option of moving into an equivalent unit or room in the same building, as soon as it is ready for occupancy. If a tenant household wishes to avail itself of this option, it must inform the owner in writing of its current address at all times during the period of displacement.

The property owner shall notify a displaced tenant household at least thirty (30) days in advance by first class mail of the availability of the unit or room including monthly rent and date of availability. The notice shall inform the tenant household that it has ten (10) days to notify property owner of their intent to move back into the property. Within ten (10) days of receipt of notice of availability of the unit or room, a tenant household wishing to move back shall so notify the owner in writing.

If a tenant household wishing to move back into the unit or room is required to pay a security deposit, the household must be permitted sufficient time to do so. In no event may that time exceed sixty (60) days.

18.25.140 – Certificate of occupancy.

The City shall not give the owner a certificate of occupancy until such time as the owner provides the Department of Development Services and Building Official with written proof that he or she has properly notified all displaced tenant households in writing of their right to return to their unit or room, or an equivalent unit or room in the same building if this is not possible, for the same rent they were paying prior to displacement for a minimum of six (6) months.

The City shall not issue the owner a certificate of occupancy until such time as the Building Official has determined that all necessary repairs have been made to the building.

18.25.150 – Appeals.

Any property owner or tenant household may contest a decision by the Department of Development Services or his or her representative regarding eligibility, relocation payment amounts, or any other determination or claim made under this chapter. To do so, the party shall file a written request for an appeal with the Director of Community Development within ten (10) days of the decision, determination or claim. The Director or his/her designee shall hold a hearing at his/her earliest opportunity and in no event more than fourteen (14) days after the Director receives notice of the appeal. All notices from the Director shall be sent to both the property owner and all tenant households affected by the appeal. The determination of the Director shall be final.

18.25.160 – Penalty.

Any person violating any provision or failing to comply with any of the requirements of this chapter shall be guilty of a misdemeanor or infraction, as determined by the City Prosecutor. In addition to any penalty imposed for a violation of this chapter, any person violating or causing or permitting the violation of this chapter shall reimburse the City for any administrative costs or expenses the City incurs in administering this chapter. Those amounts may include any provisional relocation assistance provided to tenants, such as temporary housing, moving expenses, relocation payments, public health assistance, transportation, storage or other related services.

The remedies and penalties provided for in this section and chapter shall be in addition to any other available remedies and penalties provided for by the Long Beach Municipal Code or other law.

18.25.170 – Private right of action.

Tenant households subject to displacement and/or their legal representatives shall have standing as third party beneficiaries to file an action against the owner for injunctive relief and/or actual damages pursuant to this chapter.

Nothing herein shall be deemed to interfere with the right of a property owner to file an action against a tenant or nontenant third party for the damage done to the owner's property. Nothing herein is intended to limit the damages recoverable by any party through a private action.

18.25.180 – Application to heirs.

The provisions of this chapter shall apply to all property owners and their heirs, assigns and successors in interest.

18.25.190 – Relationship to other laws.

Nothing in this chapter is intended to prevent displaced households from securing any relocation assistance and/or benefits to which they may be entitled under any other local, State or federal law.

18.25.200 – Penalty fund.

Any and all penalties levied and collected by the City pursuant to this chapter shall be placed in a revolving fund and utilized at the sole discretion of the City to advance relocation assistance to tenants or households displaced as a result of code enforcement activities.

18.25.210 – Severability.

If any provision of this chapter is held to be unconstitutional or otherwise invalid by any court of competent jurisdiction, the remaining provisions of this chapter shall not be invalidated.

CHAPTER 18.40 BUILDING CODE

- 18.40.010 – Adoption.
- 18.40.020 – Application.
- 18.40.030 – Amendments to the adopted code.
- 18.40.040 – Sections, chapters or appendices deleted from adopted code.
- 18.40.050 – Amend CBC Section 201.4—Terms not defined.
- 18.40.060 – Amend CBC Section 302.1—Classification.
- 18.40.070 – Amend CBC Section 1603.1.9—Systems and components requiring special inspections for seismic resistance.
- 18.40.080 – Amend CBC Section 1612.3—Establishment of flood hazard areas.
- 18.40.090 – Amend CBC Section 1612.5—Flood hazard documentation.
- 18.40.100 – Add CBC Section 1613.6—Minimum distance for building separation.
- 18.40.110 – Add CBC Section 1613.7—Modify ASCE 7 Section 12.2.3.1 Exception 3.
- 18.40.120 – Add CBC Section 1613.8—Modify ASCE 7, Section 12.11.2.2.3.
- 18.40.130 – Add CBC Section 1613.10—Suspended ceiling.
- 18.40.140 – Amend CBC Section 1705.3—Concrete construction.
- 18.40.150 – Amend CBC Section 1705.11—Seismic resistance.
- 18.40.160 – Amend CBC Section 1704.5—Structural observations.
- 18.40.170 – Amend CBC Section 1707—Alternate test procedure.
- 18.40.180 – Amend CBC Section 1807.1.4—Permanent wood foundation systems.
- 18.40.190 – Amend CBC Section 1807.1.6— Prescriptive design of concrete and masonry foundation walls.
- 18.40.200 – Amend CBC Section 1809.3—Stepped footings.
- 18.40.210 – Amend CBC Section 1809.7 and Table 1809.7— Prescriptive footings for light-frame construction.
- 18.40.220 – Amend CBC Section 1809.12—Timber footings.
- 18.40.230 – Amend CBC Section 1810.3.2.4—Timber.
- 18.40.240 – Amend CBC Section 2304.11.7—Wood used in retaining walls and cribs.
- 18.40.250 – Add CBC Section 2305.4—Quality of nails.
- 18.40.260 – Add CBC Section 2305.5—Hold-down connectors.
- 18.40.270 – Amend CBC Section 2306.2—Wood-frame diaphragms.
- 18.40.280 – Amend CBC Section 2306.3—Wood-frame shear walls.
- 18.40.290 – Add CBC Section 2307.2—Wood-frame shear walls.
- 18.40.300 – Amend CBC Section 2308.3.4—Braced wall line support.
- 18.40.310 – Amend CBC Section 2308.9.3.1—Alternative bracing.
- 18.40.320 – Amend CBC Section 2308.9.3.2 and Figure 2308.9.3.2—Alternate bracing wall panel adjacent to a door or window opening.
- 18.40.330 – Amend CBC Table 2308.12.4—Braced wall line sheathing.
- 18.40.340 – Amend CBC Section 2304.9.1—Fastener requirements.
- 18.40.350 – Amend CBC Section 2308.12.5—Attachment of sheathing.
- 18.40.360 – Amend CBC Section 2503.1—Inspection.
- 18.40.370 – Amend CBC Section 3307.1—Protection required.
- 18.40.380 – Amend CBC Section 3408.1—Change of occupancy, conformance.
- 18.40.390 – Amend CBC Section 3410.1—Moved structures, general.
- 18.40.400 – Amend CBC Section H101.2 of Appendix H—Signs exempt from permits.
- 18.40.410 – Amend CBC Section H105.2 of Appendix H—Permits, drawings and specifications.
- 18.40.420 – Amend CBC Section H110.1 of Appendix H— General.

CHAPTER 18.40 BUILDING CODE

18.40.010 – Adoption.

The City Council adopts and incorporates by reference as though set forth in full in this chapter the 2013 Edition of the California Building Code, including Appendices C, H, and I, but excluding sections, chapters or appendices pursuant to Section 18.40.040. The California Building Code is Part 2 of the California Code of Regulations, Title 24, also referred to as the California Building Standards Code. This part is based on the provisions of the 2012 International Building Code (model code) as developed by the International Code Council with necessary California amendments.

The adoption of the 2013 Edition of the California Building Code (herein referred to as “California Building Code”) is subject to the changes, amendments and modifications to said code as provided in this chapter, and certain provisions of the Long Beach Municipal Code, which shall remain in full force and effect as provided in this title. Such codes and code provisions shall constitute and be known as the Long Beach Building Code. A copy of the California Building Code, printed as code in book form, shall be on file in the office of the City Clerk.

18.40.020 – Application.

The provisions of the model code (the International Building Code), which are incorporated into the California Building Code, are applicable to all occupancy groups and uses regulated by the model code. The amendments made by the State agencies to the model code and incorporated into the California Building Code are applicable only to those occupancies or uses that the State agency making the amendments is authorized to regulate, as listed in Chapter 1, Division I of the California Building Code. The Building and Safety Bureau shall only enforce those amendments made by the following State agencies:

- A. The California Energy Commission (CEC) as specified in Section 1.5 of the California Building Code.
- B. The Department of Housing and Community Development (HCD) as specified in Section 1.8 of the California Building Code.
- C. The Division of the State Architect, Access Compliance (DSA/AC) as specified in Section 1.9 of the California Building Code.
- D. The Office of Statewide Health, Planning and Development (OSHPD 3) as specified in Section 1.10 of the California Building Code.
- E. The Office of the State Fire Marshal (SFM) as specified in Section 1.11 of the California Building Code.

18.40.030 – Amendments to the adopted code.

The California Building Code is amended and modified as set forth in Sections 18.40.040 through 18.40.420.

18.40.040 – Sections, chapters or appendices deleted from the adopted code.

The following sections, chapters or appendices of the California Building Code are deleted: Sections 101 through 116 of Chapter 1, Division II; Section 3412 of Chapter 34; Sections H109.2, H110.3, H110.4, H110.5, H112.4, H113.3, and H113.4 of Appendix H; and Appendices Chapter A, B, D, E, F, G, J and K.

18.40.050 – Amend CBC Section 201.4—Terms not defined.

Section 201.4 of the 2013 Edition of the California Building Code is amended to read as follows:

201.4 Terms not defined. Where terms are not defined through the methods authorized by this section, such terms shall have ordinarily accepted meanings such as the context implies. Webster's Third New International Dictionary of the English Language, Unabridged shall be considered as providing ordinarily accepted meanings.

18.40.060 – Amend CBC Section 302.1—Classification.

The last sentence in Section 302.1 of the 2013 Edition of the California Building Code is amended to read as follows:

Where a structure is proposed for a purpose that is not specifically provided for in this code or about which there is any question, such structure shall be classified, as determined by the Building Official, in the group that the occupancy most nearly resembles, according to the fire safety and relative hazard involved.

18.40.070 – Amend CBC Section 1603.1.9—Systems and components requiring special inspections for seismic resistance.

Section 1603.1.9 of the 2013 Edition of the California Building Code is amended by changing the reference to "Section 107.1, Chapter 1, Division II" to read "Chapter 18.05 of the Long Beach Municipal Code."

18.40.080 – Amend CBC Section 1612.3—Establishment of flood hazard areas.

Section 1612.3 of the 2013 Edition of the California Building Code is amended to read as follows:

1612.3 Establishment of flood hazard areas. To establish flood hazard areas, the City shall adopt a flood hazard map and supporting data. The flood hazard map shall include, at a minimum, areas of special flood hazard as identified by the Federal Emergency Management Agency in an engineering report entitled "The Flood Insurance Study for the City of Long Beach" dated July 6, 1998, as amended or revised with the accompanying Flood Insurance Rate Map (FIRM) and Flood Boundary and Floodway Map (FBFM) and related supporting data along with any revisions thereto. The adopted flood hazard map and supporting data are hereby adopted by reference and declared to be part of this section.

18.40.090 – Amend CBC Section 1612.5—Flood hazard documentation.

Section 1612.5 Item 1.1 of the 2013 Edition of the California Building Code is amended by changing the reference to "Section 110.3.3, Chapter 1, Division II" to read "Subsection 18.07.050.A.3 of the Long Beach Municipal Code."

18.40.100 – Add CBC Section 1613.6—Minimum distance for building separation.

Section 1613.6 is added to Chapter 16 of the 2013 Edition of the California Building Code to read as follows:

1613.6 ASCE 7, 12.12.3 Modify ASCE 7 Equation 12.12-1 of Section 12.12.3 to read as follows:

$$\delta_M = C_d \delta_{max} \quad (12.12-1)$$

18.40.110 – Add CBC Section 1613.7—Modify ASCE 7 Section 12.2.3.1 Exception 3.

Section 1613.7 is added to Chapter 16 of the 2013 Edition of the California Building Code to read as follows:

1613.7 ASCE 7, 12.2.3.1, Exception 3. Modify ASCE 7 Section 12.2.3.1 Exception 3 to read as follows:

3. Detached one and two family dwellings up to two stories in height of light frame construction.

18.40.120 – Add CBC Section 1613.8—Modify ASCE 7, Section 12.11.2.2.3.

Section 1613.8 is added to Chapter 16 of the 2013 Edition of the California Building Code to read as follows:

1613.8 ASCE 7, Section 12.11.2.2.3. Modify ASCE 7, Section 12.11.2.2.3 to read as follows:

12.11.2.2.3 Wood Diaphragms. In wood diaphragms, the continuous ties shall be in addition to the diaphragm sheathing. Anchorage shall not be accomplished by use of toe nails or nails subject to withdrawal nor shall wood ledgers or framing be used in cross-grain bending or cross-grain tension. The diaphragm sheathing shall not be considered effective as providing ties or struts required by this section.

For structures assigned to Seismic Design Category D, E or F, wood diaphragms supporting concrete or masonry walls shall comply with the following:

1. The spacing of continuous ties shall not exceed 40 feet. Added chords of diaphragms may be used to form subdiaphragms to transmit the anchorage forces to the main continuous crossties.
2. The maximum diaphragm shear used to determine the depth of the subdiaphragm shall not exceed 75% of the maximum diaphragm shear.

18.40.130 – Add CBC Section 1613.10—Suspended ceiling.

1613.10 Suspended Ceilings. Minimum design and installation standards for suspended ceilings shall be determined in accordance with the requirements of Section 2506.2.1 of this Code and this section.

1613.10.1 Scope. This part contains special requirements for suspended ceilings and lighting systems. Provisions of Section 13.5.6 of ASCE 7-10 shall apply except as modified herein.

1613.10.2 General. The suspended ceilings and lighting systems shall be limited to 6 feet (1828 mm) below the structural deck unless the lateral bracing is designed by a licensed engineer or architect.

1613.10.3 Sprinkler Heads. All sprinkler heads (drops) except fire-resistance-rated floor/ceiling or roof/ceiling assemblies, shall be designed to allow for free movement of the sprinkler pipes with oversize rings, sleeves or adaptors through the ceiling tile. Sprinkler heads and other penetrations shall have a 2 in. (50mm) oversize ring, sleeve, or adapter through the ceiling tile to allow for free movement of at least 1 in. (25mm) in all horizontal directions. Alternatively, a swing joint that can accommodate 1 in. (25 mm) of ceiling movement in all horizontal directions is permitted to be provided at the top of the sprinkler head extension.

Sprinkler heads penetrating fire-resistance-rated floor/ceiling or roof/ceiling assemblies shall comply with Section 714 of this Code.

1613.10.4 Special Requirements for Means of Egress. Suspended ceiling assemblies located along means of egress serving an occupant load of 30 or more shall comply with the following provisions.

1613.10.4.1 General. Ceiling suspension systems shall be connected and braced with vertical hangers attached directly to the structural deck along the means of egress serving an occupant load of 30 or more and at lobbies accessory to Group A Occupancies. Spacing of vertical hangers shall not exceed 2 feet (610 mm) on center along the entire length of the suspended ceiling assembly located along the means of egress or at the lobby.

1613.10.4.2 Assembly Device. All lay-in panels shall be secured to the suspension ceiling assembly with two hold-down clips minimum for each tile within a 4-foot (1219 mm) radius of the exit lights and exit signs.

1613.10.4.3 Emergency Systems. Independent supports and braces shall be provided for light fixtures required for exit illumination. Power supply for exit illumination shall comply with the requirements of Section 1006.3 of this Code.

1613.10.4.4 Supports for Appendage. Separate support from the structural deck shall be provided for all appendages such as light fixtures, air diffusers, exit signs, and similar elements.

18.40.140 – Amend CBC Section 1705.3—Concrete construction.

Section 1705.3 of the 2013 Edition of the California Building Code is amended to read as follows:

1705.3 Concrete Construction. The special inspections and verifications for concrete construction shall be as required by this section and Table 1705.3.

Exceptions: Special inspection shall not be required for:

1. Isolated spread concrete footings of buildings three stories or less above grade plane that are fully supported on earth or rock, where the structural design of the footing is based on a specified compressive strength, f'_c , no greater than 2,500 pounds per square inch (psi) (17.2 Mpa) regardless of the compressive strength specified in the construction documents or used in the footing construction.
2. Continuous concrete footings supporting walls of buildings three stories or less in height that are fully supported on earth or rock where:
 - 2.1. The footings support walls of light-frame construction;
 - 2.2. The footings are designed in accordance with Table 1805.4.2; or
 - 2.3. The structural design of the footing is based on a specified compressive strength, f'_c , no greater than 2,500 pounds per square inch (psi) (17.2 Mpa), regardless of the compressive strength specified in the construction documents or used in the footing construction.
3. Nonstructural concrete slabs supported directly on the ground, including prestressed slabs on grade, where the effective prestress in the concrete is less than 150 psi (1.03 Mpa).
4. Concrete patios, driveways and sidewalks, on grade.

18.40.150 – Amend CBC Section 1705.11—Seismic resistance.

Exception 3 of Section 1705.11 of the 2013 Edition of the California Building Code is amended to read as follows:

3. The structure is a detached one- or two-family dwelling not exceeding two stories above grade plane, is not assigned to Seismic Design Category D, E or F and does not have any of the following horizontal or vertical irregularities in accordance with Section 12.3 of ASCE 7:

18.40.160 – Amend CBC Section 1704.5—Structural observations.

Section 1704.5 of the 2013 Edition of the California Building Code is amended to read as follows:

1704.5 Structural observations. Where required by the provisions of Section 1704.5.1 or 1704.5.2, the owner shall employ a structural observer to perform structural observations as defined in Section 1702. The structural observer shall be one of the following individuals:

1. The registered design professional responsible for the structural design, or
2. A registered design professional designated by the registered design professional responsible for the structural design.

Prior to the commencement of observations, the structural observer shall submit to the Building Official a written statement identifying the frequency and extent of structural observations.

The owner or owner's representative shall coordinate and call a preconstruction meeting between the structural observer, contractors, affected subcontractors and special inspectors. The structural observer shall preside over the meeting. The purpose of the meeting shall be to identify the major structural elements and connections that affect the vertical and lateral load resisting systems of the structure and to review scheduling of the required observations. A record of the meeting shall be included in the report submitted to the Building Official.

Observed deficiencies shall be reported in writing to the owner or owner's representative, special inspector, contractor and the Building Official. Upon the form prescribed by the Building Official, the structural observer shall submit to the Building Official a written statement at each significant construction stage stating that the site visits have been made and identifying any reported deficiencies which, to the best of the structural observer's knowledge, have not been resolved. A final report by the structural observer which states that all observed deficiencies have been resolved is required before acceptance of the work by the Building Official.

18.40.170 – Amend CBC Section 1707—Alternate test procedure.

Section 1707 of the 2013 Edition of the California Building Code is amended by changing the reference to "Section 104.11, Chapter 1, Division II" to read "Section 18.03.060 of the Long Beach Municipal Code."

18.40.180 – Amend CBC Section 1807.1.4—Permanent wood foundation systems.

Section 1807.1.4 of the 2013 Edition of the California Building Code is amended to read as follows:

1807.1.4 Permanent wood foundation systems. Permanent wood foundation systems shall be designed and installed in accordance with AF&PA PWF. Lumber and plywood shall be treated in accordance with AWPA U1 (Commodity Specification A, Use Category 4B and Section 5.2) and shall be identified in accordance with Section 2303.1.8.1. Permanent wood foundation systems shall not be used for structures assigned to Seismic Design Category D, E or F.

18.40.190 – Amend CBC Section 1807.1.6— Prescriptive design of concrete and masonry foundation walls.

Section 1807.1.6 of the 2013 Edition of the California Building Code is amended to read as follows:

1807.1.6 Prescriptive design of concrete and masonry foundation walls. Concrete and masonry foundation walls that are laterally supported at the top and bottom shall be permitted to be designed and constructed in accordance with this section. Prescriptive design of foundation walls shall not be used for structures assigned to Seismic Design Category D, E or F.

18.40.200 – Amend CBC Section 1809.3—Stepped footings.

Section 1809.3 of the 2013 Edition of the California Building Code is amended to read as follows:

1809.3 Stepped footings. The top surface of footings shall be level. The bottom surface of footings shall be permitted to have a slope not exceeding one unit vertical in 10 units horizontal (10-percent slope). Footings shall be stepped where it is necessary to change the elevation of the top surface of the footing or where the surface of the ground slopes more than one unit vertical in 10 units horizontal (10-percent slope).

For structures assigned to Seismic Design Category D, E or F, the stepping requirement shall also apply to the top surface of grade beams supporting walls. Footings shall be reinforced with four 1/2-inch diameter (12.7 mm) deformed reinforcing bars. Two bars shall be placed at the top and bottom of the footings as shown in Figure 1809.3.

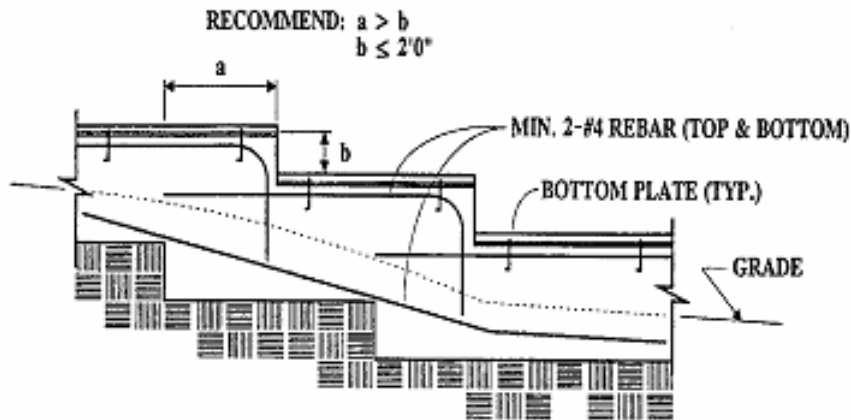

STEPPED FOUNDATIONS

FIGURE 1809.3
STEPPED FOOTING

18.40.210 – Amend CBC Section 1809.7 and Table 1809.7— Prescriptive footings for light-frame construction.

Section 1809.7 and Table 1809.7 of the 2013 Edition of the California Building Code are amended to read as follows:

1809.7 Prescriptive footings for light-frame construction. Where a specific design is not provided, concrete or masonry-unit footings supporting walls of light-frame construction shall be permitted to be designed in accordance with Table 1809.7. Prescriptive footings in Table 1809.7 shall not exceed one story above grade plane for structures assigned to Seismic Design Category D, E or F.

TABLE 1809.7
PREScriptive FOOTINGS SUPPORTING WALLS OF
LIGHT-FRAME CONSTRUCTION ^{a, b, c, d, e}

NUMBER OF FLOORS SUPPORTED BY THE FOOTING ^f	WIDTH OF FOOTING (inches)	THICKNESS OF FOOTING (inches)
1	12	6
2	15	6
3	18	8

For SI: 1 inch = 25.4 mm, 1 foot = 304.8 mm

- a. Depth of footings shall be in accordance with Section 1809.4.
- b. The ground under the floor shall be permitted to be excavated to the elevation of the top of the footing.
- c. Not Adopted.
- d. See Section 1908 for additional requirements for concrete footings of structures assigned to Seismic Design Category C, D, E or F.
- e. For thickness of foundation walls, see Section 1807.1.6.
- f. Footings shall be permitted to support a roof addition to the stipulated number of floors. Footings supporting roof only shall be as required for supporting one floor.

18.40.220 – Amend CBC Section 1809.12—Timber footings.

Section 1809.12 of the 2013 Edition of the California Building Code is amended to read as follows:

1809.12 Timber footings. Timber footings shall be permitted for buildings of Type V construction and as otherwise approved by the Building Official. Such footings shall be treated in accordance with AWPA U1 (Commodity Specification A, Use Category 4B). Treated timbers are not required where placed entirely below permanent water level, or where used as capping for wood piles that project above the water level over submerged or marsh lands. The compressive stresses perpendicular to grain in untreated timber footing supported upon treated piles shall not exceed 70 percent of the allowable stresses for the species and grade of timber as specified in the AF&PA NDS. Timber footings shall not be used in structures assigned to Seismic Design Category D, E or F.

18.40.230 – Amend CBC Section 1810.3.2.4—Timber.

Section 1810.3.2.4 of the 2013 Edition of the California Building Code is amended to read as follows:

1810.3.2.4 Timber. Timber deep foundation elements shall be designed as piles or poles in accordance with AF&PA NDS. Round timber elements shall conform to ASTM D 25. Sawn timber elements shall conform to DOC PS-20. Timber shall not be used in structures assigned to Seismic Design Category D, E or F.

18.40.240 – Amend CBC Section 2304.11.7—Wood used in retaining walls and cribs.

Section 2304.11.7 of the 2013 Edition of the California Building Code is amended to read as follows:

2304.11.7 Wood used in retaining walls and cribs. Wood installed in retaining or crib walls shall be preservative treated in accordance with AWPA U1 (Commodity Specifications A or F) for soil and fresh water use. Wood shall not be used in retaining or crib walls for structures assigned to Seismic Design Category D, E or F.

18.40.250 – Add CBC Section 2305.4—Quality of nails.

Section 2305.4 is added to Chapter 23 of the 2013 Edition of the California Building Code to read as follows:

2305.4 Quality of Nails. In Seismic Design Category D, E or F, mechanically driven nails used in wood structural panel shear walls shall meet the same dimensions as that required for hand-driven nails, including diameter, minimum length and minimum head diameter. Clipped head or box nails are not permitted in new construction. The allowable design value for clipped head nails in existing construction may be taken at no more than the nail-head-area ratio of that of the same size hand-driven nails.

18.40.260 – Add CBC Section 2305.5—Hold-down connectors.

Section 2305.5 is added to Chapter 23 of the 2013 Edition of the California Building Code to read as follows:

2305.5 Hold-down connectors. In Seismic Design Category D, E or F, hold-down connectors shall be designed to resist shear wall overturning moments using approved cyclic load values or 75 percent of

the allowable seismic load values that do not consider cyclic loading of the product. Connector bolts into wood framing shall require steel plate washers on the post on the opposite side of the anchorage device. Plate size shall be a minimum of 0.229 inch by 3 inches by 3 inches (5.82 mm by 76 mm by 76 mm) in size. Hold-down connectors shall be tightened to finger tight plus one half (1/2) wrench turn just prior to covering the wall framing.

18.40.270 – Amend CBC Section 2306.2—Wood-frame diaphragms.

Section 2306.2 of the 2013 Edition of the California Building Code is amended to read as follows:

2306.2 Wood-frame diaphragms. Wood-frame diaphragms shall be designed and constructed in accordance with AF&PA SDPWS. Where panels are fastened to framing members with staples, requirements and limitations of AF&PA SDPWS shall be met and the allowable shear values set forth in Table 2306.2(1) or 2306.2(2) shall only be permitted for structures assigned to Seismic Design Category A, B, or C.

Exception: Allowable shear values where panels are fastened to framing members with staples may be used if such values are substantiated by cyclic testing and approved by the building official.

The allowable shear values in Tables 2306.2(1) and 2306.2(2) are permitted to be increased 40 percent for wind design.

Exception: [DSA-SS, DSA-SS/CC and OSHPD 1, 2 &4] Wood structural panel diaphragms using staples as fasteners are not permitted by DSA and OSHPD.

Wood structural panel diaphragms used to resist seismic forces in structures assigned to Seismic Design Category D, E or F shall be applied directly to the framing members.

Exception: Wood structural panel diaphragms are permitted to be fastened over solid lumber planking or laminated decking, provided the panel joints and lumber planking or laminated decking joints do not coincide.

18.40.280 – Amend CBC Section 2306.3—Wood-frame shear walls.

2306.3 Wood-frame shear walls. Wood-frame shear walls shall be designed and constructed in accordance with AF&PA SDPWS. For structures assigned to Seismic Design Category D, E, or F, application of Tables 4.3A and 4.3B of AF&PA SDPWS shall include the following:

1. Wood structural panel thickness for shear walls shall not be less than 3/8 inch thick and studs shall not be spaced at more than 16 inches on center.
2. The maximum nominal unit shear capacities for 3/8 inch wood structural panels resisting seismic forces in structures assigned to Seismic Design Category D, E or F is 400 pounds per linear foot (plf).

Exception: Other nominal unit shear capacities may be permitted if such values are substantiated by cyclic testing and approved by the building official.

3. Where shear design values using allow stress design (ASD) exceed 350 plf or load and resistance factor design (LRFD) exceed 500 plf, all framing members receiving edge nailing from abutting panels shall not be less than a single 3-inch nominal member, or two 2-inch nominal members fastened together in accordance with Section 2306.1 to transfer the design shear value between framing members. Wood structural panel joint and sill plate nailing shall be staggered at all panel edges. See Section 4.3.6.1 and 4.3.6.4.3 of AF&PA SDPWS for sill plate size and anchorage requirements.
4. Nails shall be placed not less than 1/2 inch in from the panel edges and not less than 3/8 inch from the edge of the connecting members for shear greater than 350 plf using ASD or 500 plf using LRFD. Nails shall be placed not less than 3/8 inch from panel edges and not less than 1/4 inch from the edge of the connecting members for shears of 350 plf or less using ASD or 500 plf or less using LRFD.
5. Table 4.3B application is not allowed for structures assigned to Seismic Design Category D, E, or F.

For structures assigned to Seismic Design Category D, application of Table 4.3C of AF&PA SDPWS shall not be used below the top level in a multi-level building for structures.

Where panels are fastened to framing members with staples, requirements and limitations of AF&PA SDPWS shall be met and the allowable shear values set forth in Table 2306.3(1), 2306.3(2) or 2306.3(3) shall only be permitted for structures assigned to Seismic Design Category A, B, or C.

Exception: Allowable shear values where panels are fastened to framing members with staples may be used if such values are substantiated by cyclic testing and approved by the building official.

The allowable shear values in Tables 2306.3(1) and 2306.3(2) are permitted to be increased 40 percent for wind design. Panels complying with ANSI/APA PRP-210 shall be permitted to use design values for Plywood Siding in the AF&PA SDPWS.

Exception: [DSA-SS 7DSA-SS/CC and OSHPD 1, 2 &4] Wood structural panel shear walls using staples as fasteners are not permitted by DSA and OSHPD.

18.40.290 – Add CBC Section 2307.2—Wood-frame shear walls.

Section 2307.2 is added o the 2013 Edition of the California Building Code to read as follows:

2307.2 Wood-frame shear walls. Wood-frame shear walls shall be designed and constructed in accordance with Section 2306.3 as applicable.

18.40.300 – Amend CBC Section 2308.3.4—Braced wall line support.

Section 2308.3.4 of the 2013 Edition of the California Building Code is amended to read as follows:

2308.3.4 Braced wall line support. Braced wall lines shall be supported by continuous foundations.

Exception: For structures with a maximum plan dimension not over 50 feet (15240 mm), continuous foundations are required at exterior walls only for structures assigned to Seismic Design Category A, B or C.

18.40.310 – Amend CBC Section 2308.9.3.1—Alternative bracing.

Section 2308.9.3.1 Item 1 of the 2013 Edition of the California Building Code is amended to read as follow:

1. In one-story buildings, each panel shall have a length of not less than 2 feet 8 inches (813 mm) and a height of not more than 10 feet (3048 mm). Each panel shall be sheathed on one face with 3/8-inch-minimum-thickness (9.5 mm) wood structural panel sheathing nailed with 8d common or galvanized box nails in accordance with Table 2304.9.1 and blocked at wood structural panel edges. For structures assigned to Seismic Design Category D or E, each panel shall be sheathed on one face with 15/32-inch-minimum-thickness (11.9 mm) wood structural panel sheathing nailed with 8d common nails spaced 3 inches on panel edges, 3 inches at intermediate supports. Two anchor bolts installed in accordance with Section 2308.6 shall be provided in each panel. Anchor bolts shall be placed at each panel outside quarter points. Each panel end stud shall have a tie-down device fastened to the foundation, capable of providing an approved uplift capacity of not less than 1,800 pounds (8006 N). The tie-down device shall be installed in accordance with the manufacturer's recommendations. The panels shall be supported directly on a foundation or on floor framing supported directly on a foundation that is continuous across the entire length of the braced wall line. This foundation shall be reinforced with not less than one No. 4 bar top and bottom.

Where the continuous foundation is required to have a depth greater than 12 inches (305 mm), a minimum 12-inch by 12-inch (305 mm by 305 mm) continuous footing or turned down slab edge is permitted at door openings in the braced wall line. This continuous footing or turned down slab edge shall be reinforced with not less than one No. 4 bar top and bottom. This reinforcement shall be lapped 15 inches (381 mm) with the reinforcement required in the continuous foundation located directly under the braced wall line.

18.40.320 – Amend CBC Section 2308.9.3.2 and Figure 2308.9.3.2—Alternate bracing wall panel adjacent to a door or window opening.

Section 2308.9.3.2 Item 1 of the 2013 Edition of the California Building Code is amended to read as follow:

1. In one-story buildings, each panel shall have a length of not less than 16 inches (406 mm) and a height of not more than 10 feet (3048 mm). Each panel shall be sheathed on one face with a single layer of 3/8 inch (9.5 mm) minimum thickness wood structural panel sheathing nailed with 8d common or galvanized box nails in accordance with Figure 2308.9.3.2. For structures assigned to Seismic Design Category D or E, each panel shall be sheathed on one face with 15/32-inch-minimum-thickness (11.9 mm) wood structural panel sheathing nailed with 8d common nails spaced 3 inches on panel edges, 3 inches at intermediate supports and in accordance with Figure 2308.9.3.2. The wood structural panel sheathing shall extend up over the solid sawn or glued-laminated header and shall be nailed in accordance with Figure 2308.9.3.2. A built-up header consisting of at least two 2 × 12s and fastened in accordance with Item 24 of

Table 2304.9.1 shall be permitted to be used. A spacer, if used, shall be placed on the side of the built-up beam opposite the wood structural panel sheathing. The header shall extend between the inside faces of the first full-length outer studs of each panel. The clear span of the header between the inner studs of each panel shall be not less than 6 feet (1829 mm) and not more than 18 feet (5486 mm) in length. A strap with an uplift capacity of not less than 1,000 pounds (4,400 N) shall fasten the header to the inner studs opposite the sheathing. One anchor bolt not less than 5/8 inch (15.9 mm) diameter and installed in accordance with Section 2308.6 shall be provided in the center of each sill plate. The studs at each end of the panel shall have a tie-down device fastened to the foundation with an uplift capacity of not less than 4,200 pounds (18 480 N).

Where a panel is located on one side of the opening, the header shall extend between the inside face of the first full-length stud of the panel and the bearing studs at the other end of the opening. A strap with an uplift capacity of not less than 1,000 pounds (4400 N) shall fasten the header to the bearing studs. The bearing studs shall also have a tie-down device fastened to the foundation with an uplift capacity of not less than 1,000 pounds (4400 N).

The tie-down devices shall be an embedded strap type, installed in accordance with the manufacturer's recommendations. The panels shall be supported directly on a foundation that is continuous across the entire length of the braced wall line. This foundation shall be reinforced with not less than one No. 4 bar top and bottom.

Where the continuous foundation is required to have a depth greater than 12 inches (305 mm), a minimum 12-inch by 12-inch (305 mm by 305 mm) continuous footing or turned down slab edge is permitted at door openings in the braced wall line. This continuous footing or turned down slab edge shall be reinforced with not less than one No. 4 bar top and bottom. This reinforcement shall be lapped not less than 15 inches (381 mm) with the reinforcement required in the continuous foundation located directly under the braced wall line.

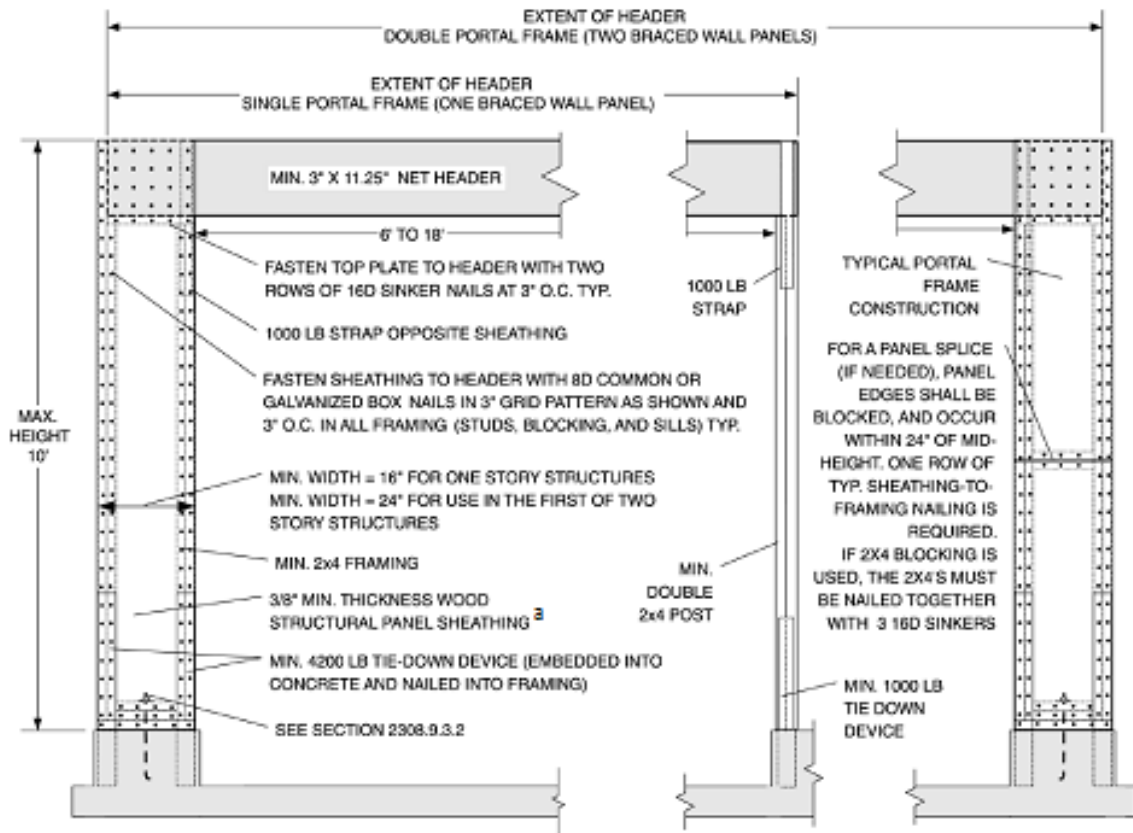

For SI: 1 foot = 304.8 mm; 1 inch = 25.4 mm; 1 pound = 4.448 N.

- a. For structures assigned to Seismic Design Category D or E, sheathed on one face with 15/32-inch minimum thickness (11.9 mm) wood structural panel sheathing nailed with 8d common nails spaced 6 inches on panel edges, 12 inches at intermediate supports.

FIGURE 2308.9.3.2
ALTERNATE BRACED WALL PANEL ADJACENT TO A DOOR OR WINDOW OPENING

18.40.330 – Amend CBC Table 2308.12.4—Braced wall line sheathing.

Table 2308.12.4 of the 2013 Edition of the California Building Code is amended to read as follows:

TABLE 2308.12.4
WALL BRACING IN SEISMIC DESIGN CATEGORIES D AND E
(Minimum Percentage of Wall Bracing per each Braced Wall Line^a)

CONDITION	SHEATHING TYPE ^b	$S_{DS} < 0.50$	$0.50 \leq S_{DS} < 0.75$	$0.75 \leq S_{DS} \leq 1.00$	$S_{DS} > 1.00$
One Story	G-P ^c	43	59	75	100
	S-W ^d	21	32	37	48

For SI: 1 inch = 25.4 mm, 1 foot = 304.8 mm.

- a. Minimum length of panel bracing of one face of the wall for S-W sheathing shall be at least 4'-0" long or both faces of the wall for G-P sheathing shall be at least 8'-0" long; h/w ratio shall not exceed 2:1. For S-W panel bracing of the same material on two faces of the wall, the minimum length is permitted to be one-half the tabulated value but the h/w ratio shall not exceed 2:1 and design for uplift is required. The 2:1 h/w ratio limitation does not apply to alternate braced wall panels constructed in accordance with Section 2308.9.3.1 or 2308.9.3.2. Wall framing to which sheathing used for bracing is applied shall be nominal 2 inch wide [actual 1 1/2 inch (38 mm)] or larger members and spaced a maximum of 16 inches on center. Braced wall panel construction types shall not be mixed within a braced wall line.
- b. G-P = gypsum board, portland cement plaster or gypsum sheathing boards; S-W = wood structural panels.
- c. Nailing as specified below shall occur at all panel edges at studs, at top and bottom plates and, where occurring, at blocking:
For 1/2-inch gypsum board, 5d (0.113 inch diameter) cooler nails at 7 inches on center;
For 5/8-inch gypsum board, No 11 gage (0.120 inch diameter) cooler nails at 7 inches on center;

For gypsum sheathing board, 1-3/4 inches long by 7/16-inch head, diamond point galvanized nails at 4 inches on center;
For gypsum lath, No. 13 gage (0.092 inch) by 1-1/8 inches long, 19/64-inch head, plasterboard at 5 inches on center;
For Portland cement plaster, No. 11 gage (0.120 inch) by 1 1/2 inches long, 7/16-inch head at 6 inches on center;

- d. S-W sheathing shall be a minimum of 15/32" thick nailed with 8d common placed 3/8 inches from panel edges and spaced not more than 6 inches on center and 12 inches on center along intermediate framing members.

18.40.340 – Amend CBC Section 2304.9.1—Fastener requirements.

Section 2304.9.1 of the 2013 Edition of the California Building Code is amended to read as follows:

2304.9.1 Fastener requirements. Connections for wood members shall be designed in accordance with the appropriate methodology in Section 2301.2. The number and size of fasteners connecting wood members shall not be less than that set forth in Table 2304.9.1. Staple fasteners in Table 2304.9.1 shall not be used to resist or transfer seismic forces in structures assigned to Seismic Design Category D, E or F.

Exception: Staples may be used to resist or transfer seismic forces when the allowable shear values are substantiated by cyclic testing and approved by the Building Official.

18.40.350 – Amend CBC Section 2308.12.5—Attachment of sheathing.

Section 2308.12.5 of the 2013 Edition of the California Building Code is amended to read as follows:

2308.12.5 Attachment of sheathing. Fastening of braced wall panel sheathing shall not be less than that prescribed in Table 2308.12.4 or 2304.9.1. Wall sheathing shall not be attached to framing members by adhesives. Staple fasteners in Table 2304.9.1 shall not be used to resist or transfer seismic forces in structures assigned to Seismic Design Category D, E or F.

Exception: Staples may be used to resist or transfer seismic forces when the allowable shear values are substantiated by cyclic testing and approved by the Building Official.

All braced wall panels shall extend to the roof sheathing and shall be attached to parallel roof rafters or blocking above with framing clips (18 gauge minimum) spaced at maximum 24 inches (6096 mm) on center with four 8d nails per leg (total eight 8d nails per clip). Braced wall panels shall be laterally braced at each top corner and at maximum 24 inches (6096 mm) intervals along the top plate of discontinuous vertical framing.

18.40.360 – Amend CBC Section 2503.1—Inspection.

Section 2503.1 of the 2013 Edition of the California Building Code is amended by changing the reference to "Section 110.3.5, Chapter 1, Division II" to read "Section 18.07.050 of the Long Beach Municipal Code."

18.40.370 – Amend CBC Section 3307.1—Protection required.

Section 3307.1 of the 2013 Edition of the California Building Code is amended to read as follows:

3307.1 Protection required. Adjoining public and private property shall be protected from damage during construction, remodeling and demolition work. Protection shall be provided for footings, foundations, party walls, chimneys, skylights and roofs. Provisions shall be made to control water runoff and erosion during construction or demolition activities. The person making or causing an excavation to be made shall provide written notice to the owners of adjoining buildings advising them that the excavation is to be made and that the adjoining buildings should be protected. Said notification shall be delivered not less than ten (10) days prior to the scheduled starting date of the excavation.

The requirements of protection of adjacent property with respect to excavations shall be as provided in Section 832 of the California Civil Code.

Prior to the issuance of any permit which authorizes an excavation where the excavation is to be of a greater depth than are the walls or foundation of any adjoining building or structure and located closer to the property line than the depth of the excavation, the owner of the subject site shall provide the Building Official with evidence that the adjacent property owner or owners have been given a thirty (30) day written notice of such intent to make an excavation. This notice shall state the depth to which such excavation is intended to be made and when the excavation will commence. This notice shall be by certified mail, return receipt requested.

This section shall not be construed to waive the requirements of the General Safety Orders of the California Department of Industrial Relations, nor the provisions of Section 832 of the California Civil Code concerning the rights of coterminous owners as to excavations.

18.40.380 – Amend CBC Section 3408.1—Change of occupancy, conformance.

Section 3408.1 of the 2013 Edition of the California Building Code is amended to read as follows:

3408.1 Conformance. No change shall be made in the use or occupancy of any building that would place the building in a different division of the same group of occupancies or in a different group of occupancies, unless such building is made to comply with the requirements of this code for such division or group of occupancies. Subject to the approval of the Building Official, the use or occupancy of existing buildings shall be permitted to be changed and the building is allowed to be occupied for purposes in other groups without conforming to all the requirements of this code for those groups, provided the new or proposed use is less hazardous, based on life and fire risk, than the existing use.

Except for groups A, E and I occupancies, which were constructed prior to January 9, 1934, and are not within the scope of Chapter 18.68 of the Long Beach Municipal Code, a change of occupancy group or division may be made to another equal or lesser hazard as listed herein. For the purpose of this section, the order of least hazardous group to highest hazardous group is as follows:

- Group U (least hazardous group)
- Groups R-3 and R-3.1
- Group S-2
- Groups B, F, L, M, H and S-1
- Groups R-1, R-2, R-2.1 and R-4
- Groups A, E and I (highest hazardous group)

Every change of use or increased occupant load within the same division of an occupancy group shall require compliance with the provisions of Chapters 3, 10 and 16 of this code applicable to the proposed use or increased occupant load if the Building Official determine that there is an overall increase in hazard to life, limb, health, property or public welfare.

18.40.390 – Amend CBC Section 3410.1—Moved structures, general.

Section 3410.1 of the 2013 Edition of the California Building Code is amended to read as follows:

3410.1 Conformance. Structures moved into or within the City shall comply with the provisions of this code for new structures and Chapter 18.60 of the Long Beach Municipal Code.

18.40.400 – Amend CBC Section H101.2 of Appendix H—Signs exempt from permits.

Section H101.2 of Appendix H of the 2013 Edition of the California Building Code is amended by deleting Item 4.

18.40.410 – Amend CBC Section H105.2 of Appendix H—Permits, drawings and specifications.

Section H105.2 of Appendix H of the 2013 Edition of the California Building Code is amended by changing the reference to "Chapter 1" to read "Chapter 18.04 of the Long Beach Municipal Code."

18.40.420 – Amend CBC Section H110.1 of Appendix H— General.

Section H110.1 of Appendix H of the 2013 Edition of the California Building Code is amended by deleting the last two sentences.

CHAPTER 18.41 RESIDENTIAL CODE

- 18.41.010 – Adoption.
- 18.41.020 – Application.
- 18.41.030 – Amendments to the adopted code.
- 18.41.040 – Sections, chapters or appendices deleted from adopted code.
- 18.41.050 – Amend CRC Section R201.4—Terms not defined.
- 18.41.060 – Amend CRC Section R301.1.3.2—Woodframe structures.
- 18.41.070 – Amend CRC Table R301.2(1)—Irregular buildings.
- 18.41.080 – Amend CRC Section R301.2.2.2.5—Irregular buildings.
- 18.41.090 – Amend CRC Section R401.1—Application, foundation.
- 18.41.100 – Amend CRC Section R403.1.2— Continuous footing.
- 18.41.110 – Amend CRC Section R403.1.3—Seismic reinforcing.
- 18.41.120 – Amend CRC Section R403.1.5—Slope.
- 18.41.130 – Amend CRC Section R404.2— Wood foundation walls.
- 18.41.140 – Add CRC Section R503.2.4—Openings in horizontal diaphragms.
- 18.41.150 – Amend CRC Table R602.3(1)—Fastener schedule for structural members.
- 18.41.160 – Amend CRC Section 602.3.2—Top plate.
- 18.41.170 – Amend CRC Table R602.3(2)—Alternate attachment.
- 18.41.180 – Amend CRC Section R602.10.2.3—Minimum number of braced wall panels.
- 18.41.190 – Amend CRC Table R602.10.3(3)—Bracing requirements.
- 18.41.200 – Amend CRC Table R602.10.4—Bracing methods.
- 18.41.210 – Amend CRC Figure R602.10.6.1—Alternate braced wall panel.
- 18.41.220 – Amend CRC Figure R602.10.6.2—Method PFH.
- 18.41.230 – Amend CRC Table R602.10.5—Minimum length of braced wall panels.
- 18.41.240 – Amend CRC Figure R602.10.6.4—Method CD-PF.
- 18.41.250 – Amend CRC Section R606.12.2.2.3—Reinforcement requirements for masonry elements.
- 18.41.260 – Add CRC Section R803.2.4—Openings in horizontal diaphragms.
- 18.41.270 – Amend CRC Section R1001.3.1—Vertical reinforcing.

CHAPTER 18.41 RESIDENTIAL CODE

18.41.010 – Adoption.

The City Council adopts and incorporates by reference as though set forth in full in this chapter The 2013 Edition of the California Residential Code, excluding sections, chapters or appendices pursuant to Section 18.41.040. The California Residential Code is Part 2.5 of the California Code of Regulations, Title 24, also referred to as the California Building Standards Code. This part is based on the provisions of the 2012 International Residential Code (model code) as developed by the International Code Council with necessary California amendments.

The adoption of the 2013 Edition of the California Residential Code (herein referred to as “California Residential Code”) is subject to the changes, amendments and modifications to said code as provided in this chapter, and certain provisions of the Long Beach Municipal Code, which shall remain in full force and effect as provided in this title. Such codes and code provisions shall constitute and be known as the Long Beach Residential Code. A copy of the California Residential Code, printed as code in book form, shall be on file in the office of the City Clerk.

18.41.020 – Application.

The provisions of the model code (the International Residential Code), which are incorporated into the California Residential Code, are applicable to all occupancy groups and uses regulated by the model code. The amendments made by the State agencies to the model code and incorporated into the California Residential Code are applicable only to those occupancies or uses that the State agency making the amendments is authorized to regulate, as listed in Chapter 1, Division I of the California Residential Code. The Building and Safety Bureau shall only enforce those amendments made by the following State agencies:

- A. The California Energy Commission (CEC) as specified in Section 1.5 of the California Residential Code.
- B. The Department of Housing and Community Development (HCD) as specified in Section 1.8 of the California Residential Code.
- C. The Division of the State Architect, Access Compliance (DSA/AC) as specified in Section 1.9 of the California Residential Code.
- D. The Office of Statewide Health, Planning and Development (OSHPD 3) as specified in Section 1.10 of the California Residential Code.
- E. The Office of the State Fire Marshal (SFM) as specified in Section 1.11 of the California Residential Code.

18.41.030 – Amendments to the adopted code.

The California Residential Code is amended and modified as set forth in Sections 18.41.040 through 18.41.270.

18.41.040 – Sections, chapters or appendices deleted from the adopted code.

The following sections, chapters or appendices of the California Residential Code are deleted: Sections R101 through R114 of Chapter 1, Division II; Section R319 of Chapter 3; Section R602.10.9.1 of Chapter 6; Parts IV through VIII; and Appendices A through Q.

18.41.050 – Amend CRC Section 201.4—Terms not defined.

Section R201.4 of the 2013 Edition of the California Residential Code is amended to read as follows:

R201.4 Terms not defined. Where terms are not defined through the methods authorized by this section, such terms shall have ordinarily accepted meanings such as the context implies. Webster's Third New International Dictionary of the English Language, Unabridged shall be considered as providing ordinarily accepted meanings.

18.41.060 – Amend CRC Section R301.1.3.2—Woodframe structures.

Section R301.1.3.2 of the 2013 Edition of the California Residential Code is amended to read as follows:

R301.1.3.2 Woodframe structures. The Building Official shall require construction documents to be approved and stamped by a California licensed architect or engineer for all dwellings of woodframe construction more than two stories and basement in height located in Seismic Design Category A, B or C. Notwithstanding other sections the law, the law establishing these provisions is found in Business and Professions Code Section 5537 and 6737.1.

The Building Official shall require construction documents to be approved and stamped by a California licensed architect or engineer for all dwellings of woodframe construction more than one story in height or with a basement located in Seismic Design Category D₀, D₁, D₂ or E.

18.41.070 – Amend CRC Table R301.2(1)—Irregular buildings.

Table R301.2(1) of the 2013 Edition of the California Residential Code is amended to read as follows:

TABLE R301.2(1)
CLIMATIC AND GEOGRAPHIC DESIGN CRITERIA

GROUND SNOW LOAD	WIND DESIGN		SEISMIC DESIGN CATEGORY ^f	SUBJECT TO DAMAGE FROM			WINTER DESIGN TEMP ^e	ICE BARRIER UNDERLAYMENT REQUIRED ^h	FLOOD HAZARDS ^g	AIR FREEZING INDEX ⁱ	MEAN ANNUAL TEMP ^j
	Speed ^d (mph)	Topographic effects ^k		Weathering ^a	Frost line Depth ^b	Termite ^c					
Zero	85	No	D ₂ or E	Negligible	12" - 24"	Very heavy	43	No		0	60

For SI: 1 pound per square foot = 0.0479 kPa, 1 mile per hour = 0.447 m/s.

- a. Weathering may require a higher strength concrete or grade of masonry than necessary to satisfy the structural requirements of this code. The weathering column shall be filled in with the weathering index (i.e., "negligible," "moderate" or "severe") for concrete as determined from the Weathering Probability Map [Figure R301.2(3)]. The grade of masonry units shall be determined from ASTM C 34, C 55, C 62, C 73, C 90, C 129, C 145, C 216 or C 652.
- b. The frost line depth may require deeper footings than indicated in Figure R403.1(1). The jurisdiction shall fill in the frost line depth column with the minimum depth of footing below finish grade.
- c. The jurisdiction shall fill in this part of the table to indicate the need for protection depending on whether there has been a history of local subterranean termite damage.
- d. The jurisdiction shall fill in this part of the table with the wind speed from the basic wind speed map [Figure R301.2(4)]. Wind exposure category shall be determined on a site-specific basis in accordance with Section R301.2.1.4.
- e. The outdoor design dry-bulb temperature shall be selected from the columns of 971/2-percent values for winter from Appendix D of the International Plumbing Code. Deviations from the Appendix D temperatures shall be permitted to reflect local climates or local weather experience as determined by the building official.
- f. The jurisdiction shall fill in this part of the table with the seismic design category determined from Section R301.2.2.1.
- g. The flood hazard map shall include, at a minimum, areas of special flood hazard as identified by the Federal Emergency Management Agency in an engineering report entitled "The Flood Insurance Study for, the City of Long Beach" dated July 6, 1998, as amended or revised with the accompanying Flood Insurance Rate Map (FIRM) and Flood Boundary and Floodway Map (FBFM) and related supporting data along with any revisions thereto.
- h. In accordance with Sections R905.2.7.1, R905.4.3.1, R905.5.3.1, R905.6.3.1, R905.7.3.1 and R905.8.3.1, where there has been a history of local damage from the effects of ice damming, the jurisdiction shall fill in this part of the table with "YES." Otherwise, the jurisdiction shall fill in this part of the table with "NO."
- i. The jurisdiction shall fill in this part of the table with the 100-year return period air freezing index (BF-days) from Figure R403.3(2) or from the 100-year (99%) value on the National Climatic Data Center data table "Air Freezing Index- USA Method (Base 32°)" at www.ncdc.noaa.gov/fpsf.html.
- j. The jurisdiction shall fill in this part of the table with the mean annual temperature from the National Climatic Data Center data table "Air Freezing Index-USA Method (Base 32°F)" at www.ncdc.noaa.gov/fpsf.html.

- k. In accordance with Section R30 1.2.1.5, where there is local historical data documenting structural damage to buildings due to topographic wind speed-up effects, the jurisdiction shall fill in this part of the table with "YES." Otherwise, the jurisdiction shall indicate "NO" in this part of the table.

18.41.080 – Amend CRC Section R301.2.2.2.5—Irregular buildings.

Items 1, 3 and 5 of Section R301.2.2.2.5 of the 2013 Edition of the California Residential Code are amended to read as follows, including the removal of the exception in each of the items:

1. When exterior shear wall lines or braced wall panels are not in one plane vertically from the foundation to the uppermost story in which they are required.
3. When the end of a braced wall panel occurs over an opening in the wall below.
5. When portions of a floor level are vertically offset.

18.41.090 – Amend CRC Section R401.1—Application, foundation.

Section R401.1 of the 2013 Edition of the California Residential Code is amended to read as follows:

R401.1 Application. The provisions of this chapter shall control the design and construction of the foundation and foundation spaces for all buildings. In addition to the provisions of this chapter, the design and construction of foundations in areas prone to flooding as established by Table R301.2(1) shall meet the provisions of Section R322. Wood foundations shall be designed and installed in accordance with AF&PA PWF.

Exception: The provisions of this chapter shall be permitted to be used for wood foundations only in the following situations:

1. In buildings that have no more than two floors and a roof.
2. When interior basement and foundation walls are constructed at intervals not exceeding 50 feet (15 240 mm).

Wood foundations in Seismic Design Category D₀, D₁ or D₂ shall not be permitted.

Exception: In non-occupied, single-story, detached storage sheds and similar uses other than carport or garage, provided the gross floor area does not exceed 200 square feet, the plate height does not exceed 12 feet in height above the grade plane at any point, and the maximum roof projection does not exceed 24 inches.

18.41.100 – Amend CRC Section R403.1.2— Continuous footing.

Section R403.1.2 of the 2013 Edition of the California Residential Code is amended to read as follows:

R403.1.2 Continuous footing in Seismic Design Categories D₀, D₁ and D₂. The braced wall panels at exterior walls of buildings located in Seismic Design Categories D₀, D₁ and D₂ shall be supported by continuous footings. All required interior braced wall panels in buildings shall be supported by continuous footings.

18.41.110 – Amend CRC Section R403.1.3—Seismic reinforcing.

Exception of Section R403.1.3 of the 2013 Edition of the California Residential Code is amended to read as follows:

Exception: In detached one- and two-family dwellings located in Seismic Design Category A, B or C which are three stories or less in height and constructed with stud bearing walls, plain concrete

footings without longitudinal reinforcement supporting walls and isolated plain concrete footings supporting columns or pedestals are permitted.

18.41.120 – Amend CRC Section R403.1.5—Slope.

Section R403.1.5 of the 2013 Edition of the California Residential Code is amended to read as follows:

R403.1.5 Slope. The top surface of footings shall be level. The bottom surface of footings shall be permitted to have a slope not exceeding one unit vertical in 10 units horizontal (10-percent slope). Footings shall be stepped where it is necessary to change the elevation of the top surface of the footing or where the surface of the ground slopes more than one unit vertical in 10 units horizontal (10-percent slope).

For structures located in Seismic Design Categories D₀, D₁ or D₂, stepped footings shall be reinforced with four 1/2-inch diameter (12.7 mm) deformed reinforcing bars. Two bars shall be placed at the top and bottom of the footings as shown in Figure R403.1.5.

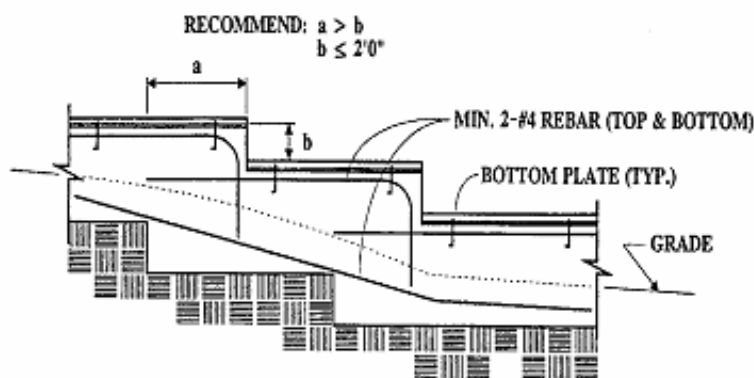

STEPPED FOUNDATIONS

FIGURE R403.1.5
STEPPED FOOTING

18.41.130 – Amend CRC Section R404.2— Wood foundation walls.

Section R404.2 of the 2013 Edition of the California Residential Code is amended to read as follows:

R404.2 Wood foundation walls. Wood foundation walls shall be constructed in accordance with the provisions of Sections R404.2.1 through R404.2.6 and with the details shown in Figures R403.1(2) and R403.1(3). Wood foundation walls shall not be used for structures located in Seismic Design Category D₀, D₁ or D₂.

18.41.140 – Add CRC Section R503.2.4—Openings in horizontal diaphragms.

Section R503.2.4 is added to Chapter 5 of the 2013 Edition of the California Residential Code to read as follows:

R503.2.4 Openings in horizontal diaphragms. Openings in horizontal diaphragms with a dimension perpendicular to the joist that is greater than 4 feet (1.2 m) shall be constructed in accordance with Figure R503.2.4.

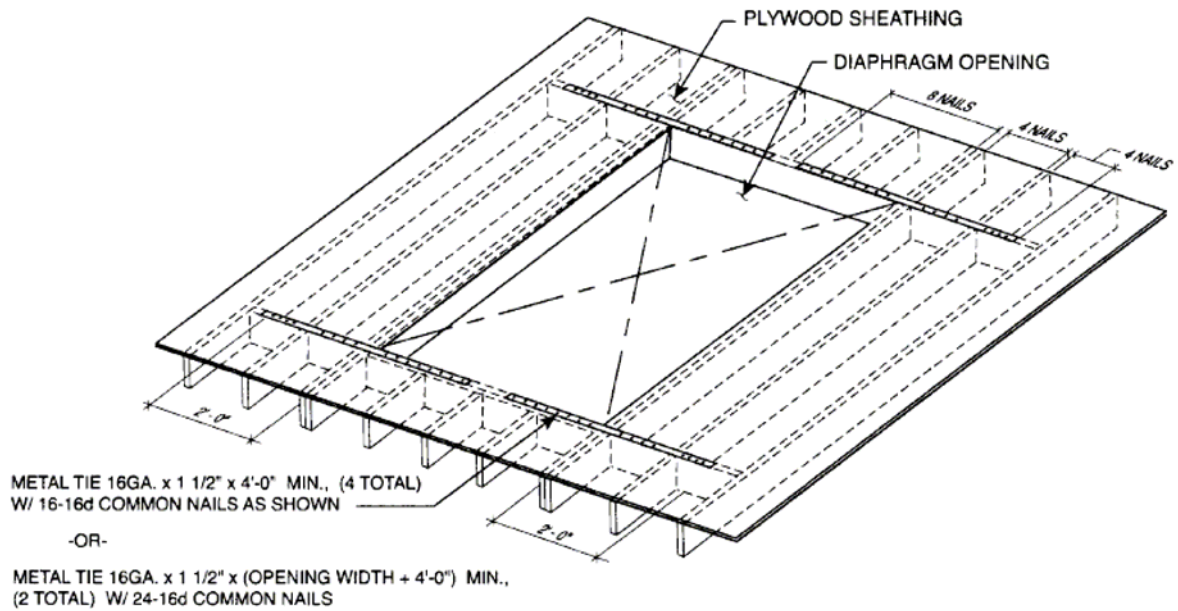

For SI: 1 inch = 25.4 mm, 1 foot = 304.8 mm.

- Blockings shall be provided beyond headers.
- Metal ties not less than 0.058 inch [1.47 mm (16 galvanized gage)] by 1.5 inches (38 mm) wide with eight 16d common nails on each side of the header-joist intersection. The metal ties shall have a minimum yield of 33,000 psi (227 MPa).
- Openings in diaphragms shall be further limited in accordance with Section R301.2.2.2.5.

FIGURE R503.2.4
OPENINGS IN HORIZONTAL DIAPHRAGMS

18.41.150 – Amend CRC Table R602.3(1)—Fastener schedule for structural members.

Footnote k is added to Lines 37 and 38 of Table R602.3(1) of the 2013 Edition of the California Residential Code to read as follows:

- Use of staples in braced wall panels shall be prohibited in Seismic Design Category D₀, D₁ or D₂.

18.41.160 – Amend CRC Section 602.3.2—Top plate.

Exception of Section 602.3.2 of the 2013 Edition of the California Residential Code is amended to read as follows:

Exception: In other than Seismic Design Category D₀, D₁ or D₂, a single top plate may be installed in stud walls, provided the plate is adequately tied at joints, corners and intersecting walls by a minimum 3-inch-by-6-inch by a 0.036-inch-thick (76 mm by 152 mm by 0.914 mm) galvanized steel plate that is nailed to each wall or segment of wall by six 8d nails on each side, provided the rafters or joists are centered over the studs with a tolerance of no more than 1 inch (25 mm). The top plate may be omitted over lintels that are adequately tied to adjacent wall sections with steel plates or equivalent as previously described.

18.41.170 – Amend CRC Table R602.3(2)—Alternate attachment.

Footnote b of Table R602.3(2) of the 2013 Edition of the California Residential Code is amended to read as follows:

b. Staples shall have a minimum crown width of 7/16-inch on diameter except as noted. Use of staples in roof, floor, subfloor, and braced wall panels shall be prohibited in Seismic Design Category D₀, D₁, or D₂.

18.41.180 – Amend CRC Section R602.10.2.3—Minimum number of braced wall panels.







Section R602.10.2.3 of the 2013 Edition of the California Residential Code is amended to read as follows:

R602.10.2.3 Minimum number of braced wall panels. Braced wall lines with a length of 16 feet (4877 mm) or less shall have a minimum of two braced wall panels of any length or one braced wall panel equal to 48 inches (1219 mm) or more. Braced wall lines greater than 16 feet (4877 mm) shall have a minimum of two braced wall panels. No braced wall panel shall be less than 48 inches in length in Seismic Design Category D₀, D₁, or D₂.

18.41.190 – Amend CRC Table R602.10.3(3)—Bracing requirements.







Table R602.10.3(3) of the 2013 Edition of the California Residential Code is amended to read as follows:

TABLE R602.10.3(3)
BRACING REQUIREMENTS BASED ON SEISMIC DESIGN CATEGORY

<ul style="list-style-type: none"> • SOIL CLASS D^b • WALL HEIGHT = 10 FEET • 10 PSF FLOOR DEAD LOAD • 15 PSF ROOF/CEILING DEAD LOAD • BRACED WALL LINE SPACING ≤ 25 FEET 			MINIMUM TOTAL LENGTH (FEET) OF BRACED WALL PANELS REQUIRED ALONG EACH BRACED WALL LINE ^a				
Seismic Design Category	Story Location	Braced Wall Line Length (feet)	Method LIB ^a	Method GB ^a	Methods DWB, SFB, PBS, PCP, HPS, CS-SFB ^{a,c}	Method WSP	Methods CS-WSP, CS-G
C (townhouses only)		10	2.5	2.5	2.5	1.6	1.4
		20	5.0	5.0	5.0	3.2	2.7
		30	7.5	7.5	7.5	4.8	4.1
		40	10.0	10.0	10.0	6.4	5.4
		50	12.5	12.5	12.5	8.0	6.8
		10	NP	4.5	4.5	3.0	2.6
		20	NP	9.0	9.0	6.0	5.1
		30	NP	13.5	13.5	9.0	7.7
		40	NP	18.0	18.0	12.0	10.2
		50	NP	22.5	22.5	15.0	12.8
		10	NP	6.0	6.0	4.5	3.8
		20	NP	12.0	12.0	9.0	7.7
		30	NP	18.0	18.0	13.5	11.5
		40	NP	24.0	24.0	18.0	15.3
		50	NP	30.0	30.0	22.5	19.1
D ₀		10	NP	5.6	5.6	1.8	1.6
		20	NP	11.0	11.0	3.6	3.1
		30	NP	16.6	16.6	5.4	4.6
		40	NP	22.0	22.0	7.2	6.1
		50	NP	27.6	27.6	9.0	7.7
		10	NP	NP	NP	3.8	3.2
		20	NP	NP	NP	7.5	6.4
		30	NP	NP	NP	11.3	9.6
		40	NP	NP	NP	15.0	12.8
		50	NP	NP	NP	18.8	16.0
		10	NP	NP	NP	5.3	4.5
		20	NP	NP	NP	10.5	9.0
		30	NP	NP	NP	15.8	13.4
		40	NP	NP	NP	21.0	17.9
		50	NP	NP	NP	26.3	22.3

(continued)

TABLE R602.10.3(3)—continued
BRACING REQUIREMENTS BASED ON SEISMIC DESIGN CATEGORY

<ul style="list-style-type: none"> • SOIL CLASS D^b • WALL HEIGHT = 10 FEET • 10 PSF FLOOR DEAD LOAD • 15 PSF ROOF/CEILING DEAD LOAD • BRACED WALL LINE SPACING ≤ 25 FEET 			MINIMUM TOTAL LENGTH (FEET) OF BRACED WALL PANELS REQUIRED ALONG EACH BRACED WALL LINE ^a				
Seismic Design Category	Story Location	Braced Wall Line Length (feet)	Method LIB ^c	Method GB ^e	Methods DWB, SFB, PBS, PCP, HPS, CS-SFB ^{d,e}	Method WSP	Methods CS-WSP, CS-G
D ₁		10	NP	6.0	6.0	2.0	1.7
		20	NP	12.0	12.0	4.0	3.4
		30	NP	18.0	18.0	6.0	5.1
		40	NP	24.0	24.0	8.0	6.8
		50	NP	30.0	30.0	10.0	8.5
		10	NP	NP	NP	4.5	3.8
		20	NP	NP	NP	9.0	7.7
		30	NP	NP	NP	13.5	11.5
		40	NP	NP	NP	18.0	15.3
		50	NP	NP	NP	22.5	19.1
		10	NP	NP	NP	6.0	5.1
		20	NP	NP	NP	12.0	10.2
		30	NP	NP	NP	18.0	15.3
		40	NP	NP	NP	24.0	20.4
		50	NP	NP	NP	30.0	25.5
D ₂		10	NP	8.0	8.0	2.5	2.1
		20	NP	16.0	16.0	5.0	4.3
		30	NP	24.0	24.0	7.5	6.4
		40	NP	32.0	32.0	10.0	8.5
		50	NP	40.0	40.0	12.5	10.6
		10	NP	NP	NP	5.5	4.7
		20	NP	NP	NP	11.0	9.4
		30	NP	NP	NP	16.5	14.0
		40	NP	NP	NP	22.0	18.7
		50	NP	NP	NP	27.5	23.4
		10	NP	NP	NP	NP	NP
		20	NP	NP	NP	NP	NP
		30	NP	NP	NP	NP	NP
		40	NP	NP	NP	NP	NP
		50	NP	NP	NP	NP	NP
	Cripple wall below one- or two-story dwelling	10	NP	NP	NP	7.5	6.4
		20	NP	NP	NP	15.0	12.8
		30	NP	NP	NP	22.5	19.1
		40	NP	NP	NP	30.0	25.5
		50	NP	NP	NP	37.5	31.9

For SI: 1 inch = 25.4 mm, 1 foot = 305 mm, 1 pound per square foot = 0.0479 kPa.

- a. Linear interpolation shall be permitted.
- b. Wall bracing lengths are based on a soil site class "D." Interpolation of bracing length between the S_{ds} values associated with the Seismic Design Categories shall be permitted when a site-specific S_{ds} value is determined in accordance with Section 1613.3 of the *California Building Code*.
- c. Method LIB shall have gypsum board fastened to at least one side with nails or screws per Table R602.3(1) for exterior sheathing or Table R702.3.5 for interior gypsum board. Spacing of fasteners at panel edges shall not exceed 8 inches.
- d. Method CS-SFB applies in SDC C only.
- e. Method GB and PCP braced wall panel h/w ratio shall not exceed 1:1 in SDC D₀, D₁ or D₂. Methods DWB, SFB, PBS and HPS are not permitted in SDC D₀, D₁ or D₂.

18.41.200 – Amend CRC Table R602.10.4—Bracing methods.

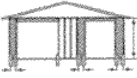
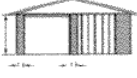



Table R602.10.4 of the 2013 Edition of the California Residential Code is amended to read as follows:

**TABLE R602.10.4
BRACING METHODS**

METHODS, MATERIAL	MINIMUM THICKNESS	FIGURE	CONNECTION CRITERIA*		
			Fasteners	Spacing	
Intermittent Bracing Method	LIB Let-in-bracing	1 × 4 wood or approved metal straps at 45° to 60° angles for maximum 16" stud spacing		Wood: 2-8d common nails or 3-8d (2 1/2" long x 0.113" dia.) nails Metal strap: per manufacturer	Wood: per stud and top and bottom plates Metal: per manufacturer
	DWB Diagonal wood boards	3/4" (1" nominal) for maximum 24" stud spacing		2-8d (2 1/2" long x 0.113" dia.) nails or 2 - 1 3/4" long staples	Per stud
	WSP Wood structural panel (See Section R604)	15/32"		8d common (2 1/2" x 0.131) nails 3/8" edge distance to panel edge	6" edges 12" field
	BV-WSP* Wood Structural Panels with Stone or Masonry Veneer (See Section R602.10.6.5)	7/16"	See Figure R602.10.6.5	8d common (2 1/2" x 0.131) nails	4" at panel edges 12" at intermediate supports 4" at braced wall panel end posts
	SFB Structural fiberboard sheathing	1/2" or 25/32" for maximum 16" stud spacing		1 1/2" long x 0.12" dia. (for 1/2" thick sheathing) 1 3/4" long x 0.12" dia. (for 25/32" thick sheathing) galvanized roofing nails or 8d common (2 1/2" long x 0.131" dia.) nails	3" edges 6" field
	GB Gypsum board	1/2"		Nails or screws per Table R602.3(1) for exterior locations Nails or screws per Table R702.3.5 for interior locations	For all braced wall panel locations: 7" edges (including top and bottom plates) 7" field
	PBS Particleboard sheathing (See Section R605)	3/8" or 1/2" for maximum 16" stud spacing		For 3/8", 6d common (2" long x 0.113" dia.) nails For 1/2", 8d common (2 1/2" long x 0.131" dia.) nails	3" edges 6" field
	PCP Portland cement plaster	See Section R703.6 for maximum 16" stud spacing		1 1/2" long, 11 gage, 7/16" dia. head nails or 7/8" long, 16 gage staples 9	6" o.c. on all framing members
	HPS Hardboard panel siding	7/16" for maximum 16" stud spacing		0.092" dia., 0.225" dia. head nails with length to accommodate 1 1/2" penetration into studs	4" edges 8" field
	ABW Alternate braced wall	3/8"		See Section R602.10.6.1	See Section R602.10.6.1

(continued)

TABLE R602.10.4—continued
BRACING METHODS

METHODS, MATERIAL	MINIMUM THICKNESS	FIGURE	CONNECTION CRITERIA*		
			Fasteners	Spacing	
Intermittent Bracing Methods	PFH Portal frame with hold-downs	$\frac{3}{8}$ "		See Section R602.10.6.2	See Section R602.10.6.2
	PFG Portal frame at garage	$\frac{7}{16}$ "	6" edges 12" field 	See Section R602.10.6.3	See Section R602.10.6.3
Continuous Sheathing Methods	CS-WSP Continuously sheathed wood structural panel	$\frac{15}{32}$ "		8d common ($2\frac{1}{2}$ " x 0.131) nails $\frac{3}{8}$ " edge distance to panel edge	6" edges 12" field
	CS-G^{b,c} Continuously sheathed wood structural panel adjacent to garage openings	$\frac{15}{32}$ "		See Method CS-WSP	See Method CS-WSP
	CS-PF Continuously sheathed portal frame	$\frac{15}{32}$ "		See Section R602.10.6.4	See Section R602.10.6.4
	CS-SFB^d Continuously sheathed structural fiberboard	$\frac{1}{2}$ " or $\frac{25}{32}$ " for maximum 16" stud spacing		$1\frac{1}{2}$ " long x 0.12" dia. (for $\frac{1}{2}$ " thick sheathing) $1\frac{3}{4}$ " long x 0.12" dia. (for $\frac{25}{32}$ " thick sheathing) galvanized roofing nails or 8d common ($2\frac{1}{2}$ " long x 0.131" dia.) nails	3" edges 6" field

For SI: 1 inch = 25.4 mm, 1 foot = 305 mm, 1 degree = 0.0175 rad, 1 pound per square foot = 47.8 N/m², 1 mile per hour = 0.447 m/s.

- a. Adhesive attachment of wall sheathing, including Method GB, shall not be permitted in Seismic Design Categories C, D₀, D₁ and D₂.
- b. Applies to panels next to garage door opening when supporting gable end wall or roof load only. May only be used on one wall of the garage. In Seismic Design Categories D₀, D₁ and D₂, roof covering dead load may not exceed 3 psf.
- c. Garage openings adjacent to a Method CS-G panel shall be provided with a header in accordance with Table R502.5(1). A full height clear opening shall not be permitted adjacent to a Method CS-G panel.
- d. Method CS-SFB does not apply in Seismic Design Categories D₀, D₁ and D₂ and in areas where the wind speed exceeds 100 mph.
- e. Method applies to detached one- and two-family dwellings in Seismic Design Categories D₀ through D₂ only.
- f. Methods GB and PCP braced wall panel h/w ratio shall not exceed 1:1 in SDC D0, D1 or D2. Methods LIB, DWB, SFB, PBS, HPS and PFG are not permitted in SCD D0, D1 or D2.
- g. Use of staples in braced wall panels shall be prohibited in SDC D0, D1 or D2.

18.41.210 – Amend CRC Figure R602.10.6.1—Alternate braced wall panel.

Figure R602.10.6.1 of the 2013 Edition of the California Residential Code is amended to read as follows:

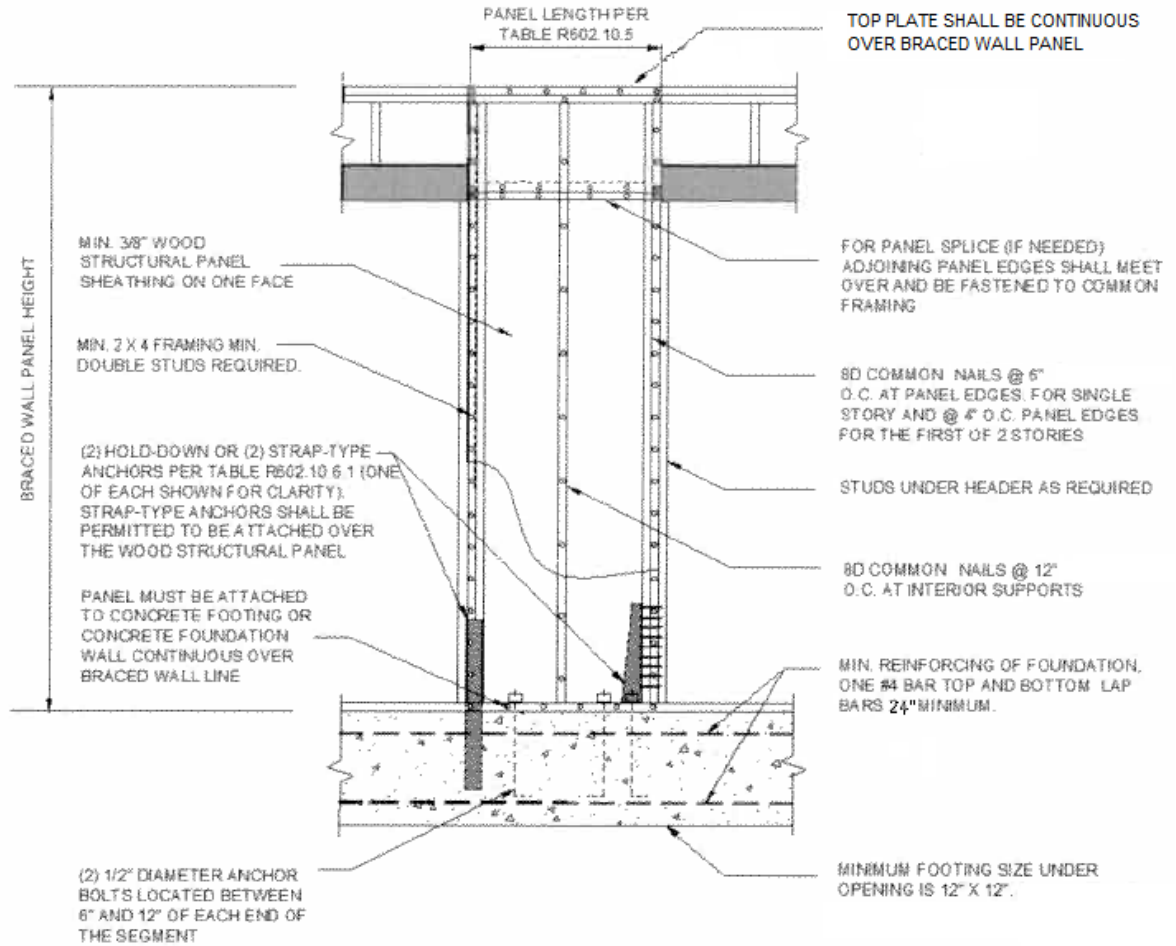

For SI: 1 inch = 25.4 mm.

**FIGURE R602.10.6.1
METHOD ABW—ALTERNATE BRACED WALL PANEL**

18.41.220 – Amend CRC Figure R602.10.6.2—Method PFH.

Figure R602.10.6.2 of the 2013 Edition of the California Residential Code is amended to read as follows:

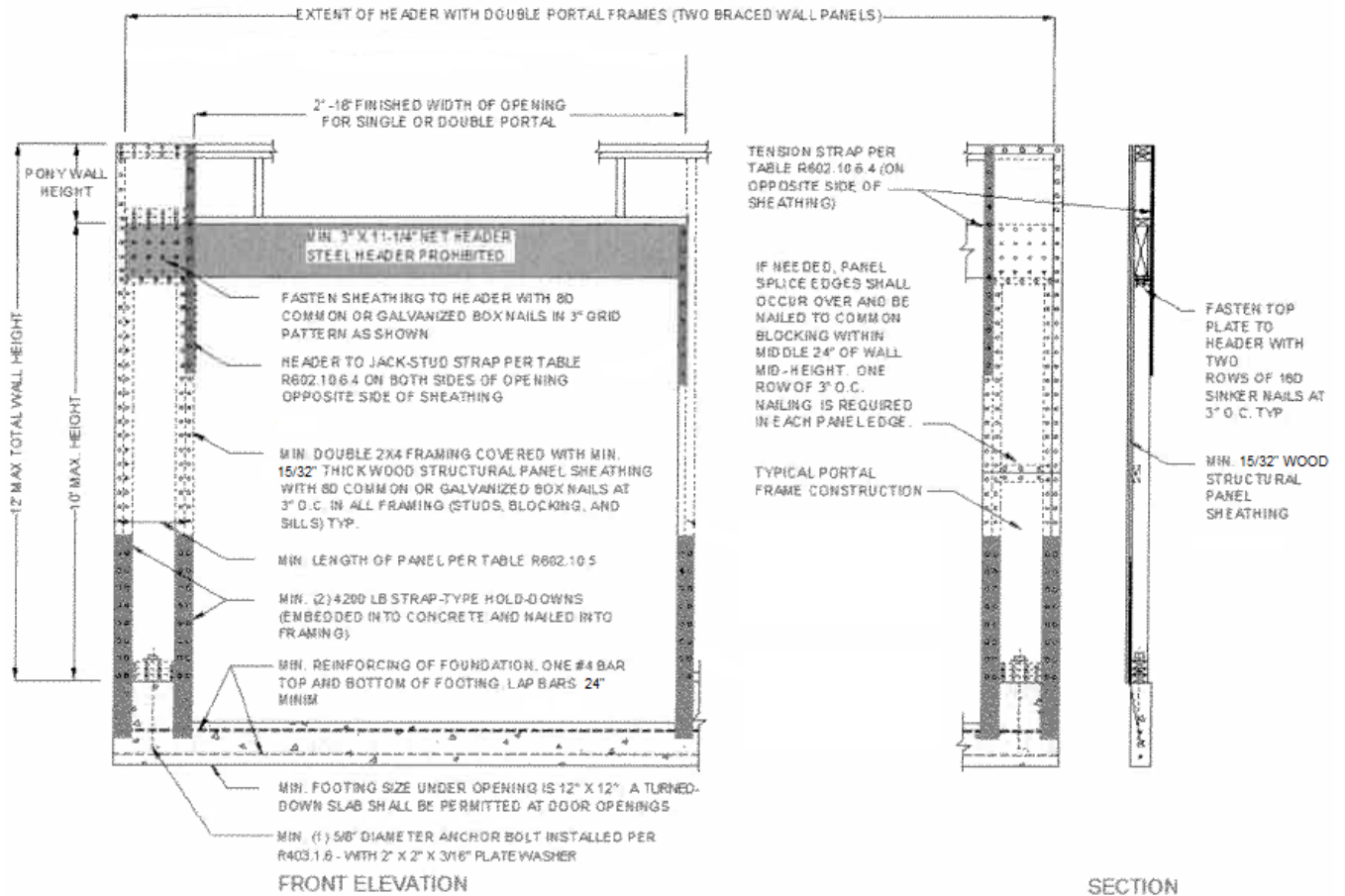

For SI: 1 inch = 25.4 mm, 1 foot = 304.8 mm.

**FIGURE R602.10.6.2
METHOD PFH—PORTAL FRAME WITH HOLD-DOWNS
AT DETACHED GARAGE DOOR OPENINGS**

18.41.230 – Amend CRC Table R602.10.5—Minimum length of braced wall panels.

Table R602.10.5 of the 2013 Edition of the California Residential Code is amended to read as follows:

**TABLE R602.10.5
MINIMUM LENGTH OF BRACED WALL PANELS**

METHOD (See Table R602.10.4)		MINIMUM LENGTH* (inches)					CONTRIBUTING LENGTH (inches)
		Wall Height					
		8 feet	9 feet	10 feet	11 feet	12 feet	
DWB, WSP, SFB, PBS, PCP, HPS, BV-WSP		48	48	48	53	58	Actual ^b
GB		48	48	48	53	58	Double sided = Actual Single sided = 0.5 × Actual
LIB		55	62	69	NP	NP	Actual ^b
ABW	SDC A, B and C, wind speed < 110 mph	28	32	34	38	42	48
	SDC D ₀ , D ₁ and D ₂ , wind speed < 110 mph	32	32	34	NP	NP	
PFH	Supporting roof only	24	24	24	24 ^c	24 ^c	48
	Supporting one story and roof	24	24	24	27 ^c	29 ^c	48
PFG		24	27	30	33 ^d	36 ^d	1.5 × Actual ^b
CS-G		24	27	30	33	36	Actual ^b
CS-PF		24	24	24	24 ^e	24 ^e	Actual ^b
CS-WSP, CS-SFB	Adjacent clear opening height (inches)						Actual ^b
	≤ 64	24	27	30	33	36	
	68	26	27	30	33	36	
	72	27	27	30	33	36	
	76	30	29	30	33	36	
	80	32	30	30	33	36	
	84	35	32	32	33	36	
	88	38	35	33	33	36	
	92	43	37	35	35	36	
	96	48	41	38	36	36	
	100	—	44	40	38	38	
	104	—	49	43	40	39	
	108	—	54	46	43	41	
	112	—	—	50	45	43	
	116	—	—	55	48	45	
	120	—	—	60	52	48	
	124	—	—	—	56	51	
	128	—	—	—	61	54	
132	—	—	—	66	58		
136	—	—	—	—	62		
140	—	—	—	—	66		
144	—	—	—	—	72		

For SI: 1 inch = 25.4 mm, 1 foot = 304.8 mm, 1 mile per hour = 0.447 m/s.

NP = Not Permitted.

- a. Linear interpolation shall be permitted.
- b. Use the actual length when it is greater than or equal to the minimum length.
- c. Maximum header height for PFH is 10 feet in accordance with Figure R602.10.6.2, but wall height may be increased to 12 feet with pony wall.
- d. Maximum opening height for PFG is 10 feet in accordance with Figure R602.10.6.3, but wall height may be increased to 12 feet with pony wall.
- e. Maximum opening height for CS-PF is 10 feet in accordance with Figure R602.10.6.4, but wall height may be increased to 12 feet with pony wall.

18.41.240 – Amend CRC Figure R602.10.6.4—Method CD-PF.

Figure R602.10.6.4 of the 2013 Edition of the California Residential Code is amended to read as follows:

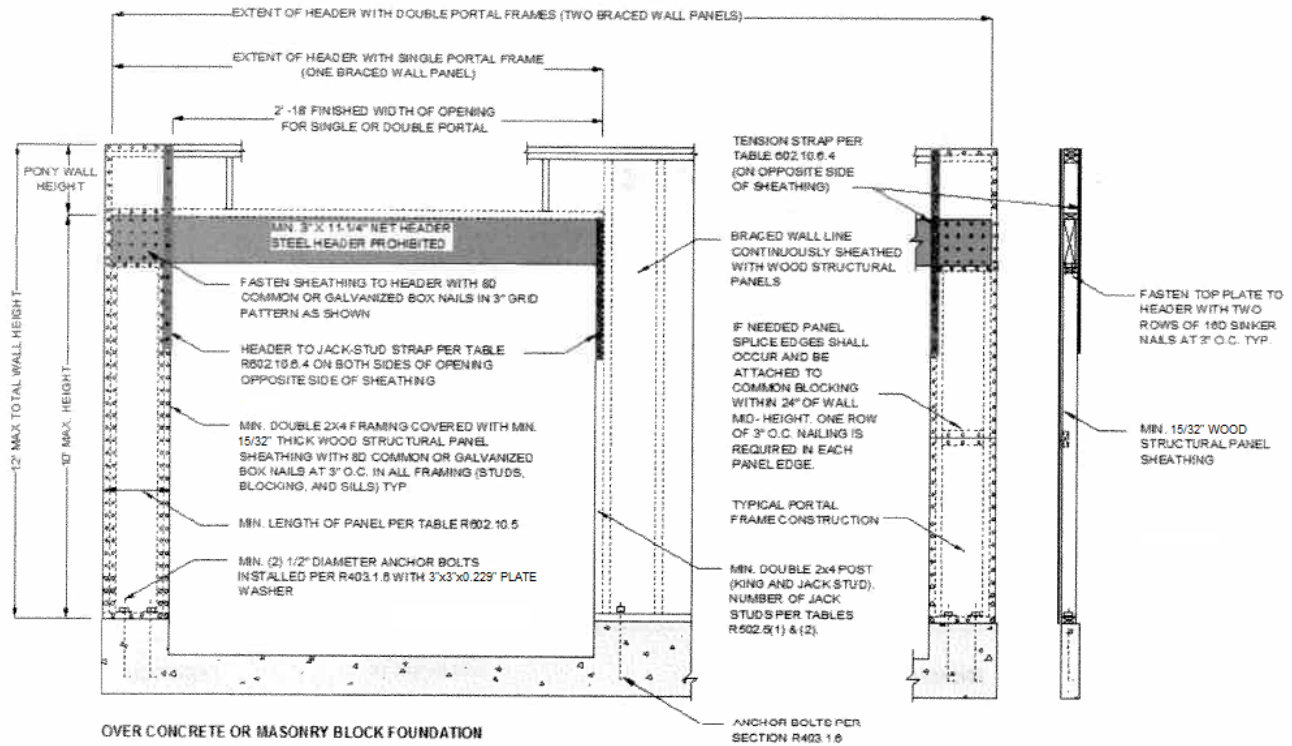

For SI: 1 inch = 25.4 mm, 1 foot = 304.8 mm.

FIGURE R602.10.6.4
METHOD CS-PF—CONTINUOUSLY SHEATHED PORTAL FRAME PANEL CONSTRUCTION

18.41.250 – Amend CRC Section R606.12.2.2.3—Reinforcement requirements for masonry elements.

Section R606.12.2.2.3 of the 2013 Edition of the California Residential Code is amended to read as follows:

R606.12.2.2.3 Reinforcement requirements for masonry elements. Masonry elements listed in Section R606.12.2.2.2 shall be reinforced in either the horizontal or vertical direction as shown in Figure R606.11(3) and in accordance with the following:

1. Horizontal reinforcement. Horizontal joint reinforcement shall consist of at least one No. 4 bar spaced not more than 48 inches (1219 mm). Horizontal reinforcement shall be provided within 16 inches (406 mm) of the top and bottom of these masonry elements.
2. Vertical reinforcement. Vertical reinforcement shall consist of at least one No. 4 bar spaced not more than 48 inches (1219 mm). Vertical reinforcement shall be within 8 inches (406mm) of the ends of masonry walls.

18.41.260 – Add CRC Section R803.2.4—Openings in horizontal diaphragms.

Section R803.2.4 is added to Chapter 8 of the 2013 Edition of the California Residential Code to read as follows:

R803.2.4 Openings in horizontal diaphragms. Openings in horizontal diaphragms shall conform with Section R503.2.4.

18.41.270 – Amend CRC Section R1001.3.1—Vertical reinforcing.

Section R1001.3.1 of the 2013 Edition of the California Residential Code is amended to read as follows:

R1001.3.1 Vertical reinforcing. For chimneys up to 40 inches (1016 mm) wide, four No. 4 continuous vertical bars adequately anchored into the concrete foundation shall be placed between wythes of solid masonry or within the cells of hollow unit masonry and grouted in accordance with Section R609. Grout shall be prevented from bonding with the flue liner so that the flue liner is free to move with thermal expansion. For chimneys more than 40 inches (1016 mm) wide, two additional No. 4 vertical bars adequately anchored into the concrete foundation shall be provided for each additional flue incorporated into the chimney or for each additional 40 inches (1016 mm) in width or fraction thereof.

CHAPTER 18.42 ELECTRICAL CODE

18.42.010 – Adoption.

18.42.020 – Application.

18.42.030 – Amendments to the adopted code.

18.42.040 –Articles, chapters or annexes deleted from adopted code.

CHAPTER 18.42 ELECTRICAL CODE

18.42.010 – Adoption.

The City Council adopts and incorporates by reference as though set forth in full in this chapter the 2013 Edition of the California Electrical Code, including Annexes A, B and C, but excluding articles, chapters or annexes pursuant to Section 18.42.040. The California Electrical Code is Part 3 of the California Code of Regulations, Title 24, also referred to as the California Building Standards Code. This part is based on the provisions of the 2011 National Electrical Code (model code) as developed by the National Fire Protection Association with necessary California amendments.

The adoption of the 2013 Edition of the California Electrical Code (herein referred to as “California Electrical Code”) is subject to the changes, amendments and modifications to said code as provided in this chapter, and certain provisions of the Long Beach Municipal Code, which shall remain in full force and effect as provided in this title. Such codes and code provisions shall constitute and be known as the Long Beach Electrical Code. A copy of the California Electrical Code, printed as code in book form, shall be on file in the office of the City Clerk.

18.42.020 – Application.

The provisions of the model code (the National Electrical Code), which are incorporated into the California Electrical Code, are applicable to all occupancy groups and uses regulated by the model code. The amendments made by the State agencies to the model code and incorporated into the California Electrical Code are applicable only to those occupancies or uses that the State agency making the amendments is authorized to regulate, as listed in Article 89 of the California Electrical Code. The Building and Safety Bureau shall only enforce those amendments made by the following State agencies:

- A. The California Energy Commission (CEC) as specified in Article 89.105 of the California Electrical Code.
- B. The Department of Housing and Community Development (HCD) as specified in Article 89.108 of the California Electrical Code.
- C. The Division of the State Architect, Access Compliance (DSA/AC) as specified in Article 89.109 of the California Electrical Code.
- D. The Office of Statewide Health, Planning and Development (OSHPD 3) as specified in Article 89.110 of the California Electrical Code.
- E. The Office of the State Fire Marshal (SFM) as specified in Article 89.111 of the California Electrical Code.

18.42.030 – Amendments to the adopted code.

The California Electrical Code is amended and modified as set forth in Section 18.42.040.

18.42.040 – Articles, chapters or annexes deleted from the adopted code.

The following sections, chapters or annexes of the California Electrical Code are deleted: Annexes D, E, F, G, H, and I.

CHAPTER 18.43 PLUMBING CODE

18.43.010 – Adoption.

18.43.020 – Application.

18.43.030 – Amendments to the adopted code.

18.43.040 – Sections, chapters or appendices deleted from adopted code.

18.43.050 – Amend CPC Section 403.3.1.1—Non water urinal drainage connection.

18.43.060 – Amend CPC Section 604.11—Lead content.

CHAPTER 18.43 PLUMBING CODE

18.43.010 – Adoption.

The City Council adopts and incorporates by reference as though set forth in full in this chapter the 2013 Edition of the California Plumbing Code, including Appendices A, B, D, I and K, but excluding sections, chapters or appendices pursuant to Section 18.43.040. The California Plumbing Code is Part 5 of the California Code of Regulations, Title 24, also referred to as the California Building Standards Code. This part is based on the provisions of the 2012 Uniform Plumbing Code (model code) as developed by the International Association of Plumbing and Mechanical Officials with necessary California amendments.

The adoption of the 2013 Edition of the California Plumbing Code (herein referred to as “California Plumbing Code”) is subject to the changes, amendments and modifications to said code as provided in this chapter, and certain provisions of the Long Beach Municipal Code, which shall remain in full force and effect as provided in this title. Such codes and code provisions shall constitute and be known as the Long Beach Plumbing Code. A copy of the California Plumbing Code, printed as code in book form, shall be on file in the office of the City Clerk.

18.43.020 – Application.

The provisions of the model code (the Uniform Plumbing Code), which are incorporated into the California Plumbing Code, are applicable to all occupancy groups and uses regulated by the model code. The amendments made by the State agencies to the model code and incorporated into the California Plumbing Code are applicable only to those occupancies or uses that the State agency making the amendments is authorized to regulate, as listed in Chapter 1, Division I of the California Plumbing Code. The Building and Safety Bureau shall only enforce those amendments made by the following State agencies:

- A. The California Energy Commission (CEC) as specified in Section 1.5 of the California Plumbing Code.
- B. The Department of Housing and Community Development (HCD) as specified in Section 1.8 of the California Plumbing Code.
- C. The Division of the State Architect, Access Compliance (DSA/AC) as specified in Section 1.9 of the California Plumbing Code.
- D. The Office of Statewide Health, Planning and Development (OSHPD 3) as specified in Section 1.10 of the California Plumbing Code.
- E. The Office of the State Fire Marshal (SFM) as specified in Section 1.11 of the California Plumbing Code.

18.43.030 – Amendments to the adopted code.

The California Plumbing Code is amended and modified as set forth in Sections 18.43.040 through 18.43.060.

18.43.040 – Sections, chapters or appendices deleted from the adopted code.

The following sections, chapters or appendices of the California Plumbing Code are deleted: Sections 101.0 through 103.8 and Table 103.4 of Chapter 1, Division II; and Appendices G and L.

18.43.050 – Amend CPC Section 403.3.1.1—Non water urinal drainage connection.

Section 403.3.1.1 of the 2013 Edition of the California Plumbing Code is amended by deleting the reference to "(HCD)".

18.43.060 – Amend CPC Section 604.11—Lead content.

Section 604.11 of the 2013 Edition of the California Plumbing Code is amended to read as follows:

604.11 Lead Content. Water pipe, plumbing fittings, fixtures, solder, and flux with lead content used to convey potable water shall comply with the Section 116875 of the California Health and Safety Code.

CHAPTER 18.44 MECHANICAL CODE

18.44.010 – Adoption.

18.44.020 – Application.

18.44.030 – Amendments to the adopted code.

18.44.040 – Sections, chapters or appendices deleted from adopted code.

CHAPTER 18.44 MECHANICAL CODE

18.44.010 – Adoption.

The City Council adopts and incorporates by reference as though set forth in full in this chapter the 2013 Edition of the California Mechanical Code, including Appendices A, B, C and D, but excluding sections, chapters or appendices pursuant to Section 18.44.040. The California Mechanical Code is Part 4 of the California Code of Regulations, Title 24, also referred to as the California Building Standards Code. This part is based on the provisions of the 2012 Uniform Mechanical Code (model code) as developed by the International Association of Plumbing and Mechanical Officials with necessary California amendments.

The adoption of the 2013 Edition of the California Mechanical Code (herein referred to as “California Mechanical Code”) is subject to the changes, amendments and modifications to said code as provided in this chapter, and certain provisions of the Long Beach Municipal Code, which shall remain in full force and effect as provided in this title. Such codes and code provisions shall constitute and be known as the Long Beach Mechanical Code. A copy of the California Mechanical Code, printed as code in book form, shall be on file in the office of the City Clerk.

18.44.020 – Application.

The provisions of the model code (the Uniform Mechanical Code), which are incorporated into the California Mechanical Code, are applicable to all occupancy groups and uses regulated by the model code. The amendments made by the State agencies to the model code and incorporated into the California Mechanical Code are applicable only to those occupancies or uses that the State agency making the amendments is authorized to regulate, as listed in Chapter 1, Division II of the California Mechanical Code. The Building and Safety Bureau shall only enforce those amendments made by the following State agencies:

- A. The California Energy Commission (CEC) as specified in Section 1.5 of the California Mechanical Code.
- B. The Department of Housing and Community Development (HCD) as specified in Section 1.8 of the California Mechanical Code.
- C. The Division of the State Architect, Access Compliance (DSA/AC) as specified in Section 1.9 of the California Mechanical Code.
- D. The Office of Statewide Health, Planning and Development (OSHPD 3) as specified in Section 1.10 of the California Mechanical Code.
- E. The Office of the State Fire Marshal (SFM) as specified in Section 1.11 of the California Mechanical Code.

18.44.030 – Amendments to the adopted code.

The California Mechanical Code is amended and modified as set forth in Section 18.44.040.

18.44.040 – Sections, chapters or appendices deleted from the adopted code.

The following sections, chapters or appendices of the California Mechanical Code are deleted: Sections 101.0 through 118.0 and Table 114.1 of Chapter 1, Division II; and Appendices E, F and G.

CHAPTER 18.45 HOUSING CODE

18.45.010 – Adoption.

18.45.020 – Application.

18.45.030 – Amendments to the adopted code.

18.45.040 – Sections, chapters or appendices deleted from adopted code.

18.45.050 – Add UHC Chapter 17—Prohibited uses and maintenance.

CHAPTER 18.45 HOUSING CODE

18.45.010 – Adoption.

The City Council adopts and incorporates by reference as though set forth in full in this chapter the 1997 Edition of the Uniform Housing Code, excluding sections, chapters or appendices pursuant to Section 18.45.040. Adoption and enforcement of the Uniform Housing Code is mandated through the State Housing Law pursuant to Section 17960, Part 1.5, Division 13, of the California Health and Safety Code. Section 17922 of the California Health and Safety Code requires the adoption of the latest edition of the Uniform Housing Code. The 1997 Edition of the Uniform Housing Code was adopted by the California Department of Housing and Community Development as provided for in Section 32, Article 5, Subchapter 1, Division 1, of Title 25 of the California Code of Regulations. The provisions of the 1997 Uniform Housing Code were developed by the International Conference of Building Officials.

The adoption of the 1997 Edition of the Uniform Housing Code (herein referred to as “Uniform Housing Code”) is subject to the changes, amendments and modifications to said code as provided in this chapter, and certain provisions of the Long Beach Municipal Code, which shall remain in full force and effect as provided in this title. Such codes and code provisions shall constitute and be known as the Long Beach Housing Code. A copy of the Uniform Housing Code, printed as code in book form, shall be on file in the office of the City Clerk.

18.45.020 – Application.

The provisions of the Uniform Housing Code are applicable to all occupancy groups and uses intended for human habitation.

18.45.030 – Amendments to the adopted code.

The Uniform Housing Code is amended and modified as set forth in Sections 18.45.040 and 18.45.050.

18.45.040 – Sections, chapters or appendices deleted from the adopted code.

The following sections, chapters or appendices of the Uniform Housing Code are deleted: Chapters 1, 2, 3, 4, 10, 11, 12, 13, 14, 15 and 16.

18.45.050 – Add UHC Chapter 17—Prohibited uses and maintenance.

Chapter 17 is added to the 1997 Edition of the Uniform Housing Code to read as follows:

Chapter 17 PROHIBITED USES AND MAINTENANCE

SECTION 1701 – PROHIBITED USES

- A. **Cooking.** It shall be unlawful for any person to cook or prepare food or to permit another person to cook or prepare food in any bath, shower, slop sink, toilet room, water closet compartment, any room not designed and intended to be used as a kitchen, or in any other portion of a building in which the cooking or preparation of food is detrimental to the health of the occupants or the proper sanitation of the building.
- B. **Sleeping.** It shall be unlawful for any person to use or to permit another person to use any of the following portions of a building for sleeping purposes:
 - 1. Kitchen, hallway, water closet, bath, cellar, shower compartment or slop sink room.

2. Any other room or place which does not comply with the provisions of this code as a sleeping room or in which sleeping is dangerous to life or health.

SECTION 1702 – MAINTENANCE AND REPAIR

- A. Maintenance. Every building shall be maintained in good repair.
- B. Roof. The roof of every building shall be kept watertight and all storm or casual water shall be properly drained and conveyed from the roof to a storm drain or street gutter in accordance with other applicable provisions of this chapter.
- C. Drainage. All portions of a lot about a building, including the yards, areaways, vent shafts, court and passageways, shall be graded and drained to efficiently carry the water away from the building.
- D. Surfacing. If the Building Official finds it necessary for the protection of the health and safety of the occupants, or for the proper sanitation of a dwelling, apartment house or hotel, it may require that the yards, areaways, vent shafts, court, passageways, or other parts of the lot surrounding the building be graveled, or properly paved and surfaced with concrete, asphalt or similar materials.
- E. Painting of room walls and ceilings. The walls and ceilings of every room in a dwelling, apartment house or hotel shall be finished, sealed, coated or covered in an approved manner. Approved materials shall be applied as often as may be necessary to maintain the walls and ceilings in a clean and sanitary condition.
- F. Painting of court and shaft walls. Unless built of light-colored materials, the walls of courts and shafts shall be painted in a light color, or shall be whitewashed. The paint or whitewash shall be applied as often as may be necessary to maintain the walls in a light color.
- G. Wallpaper. Not more than two (2) thicknesses of wallpaper shall be placed upon any wall, partition, or ceiling of any room in any dwelling, apartment house or hotel. If any wall, partition, or ceiling with two (2) thicknesses of wallpaper in any such room is to be repapered, the old wallpaper shall first be removed. Any wallpaper which has become loose or dilapidated shall be removed and the surface repapered, calcimined or painted.
- H. Painting of wallpaper. Paint or calcimine over wallpaper is permissible if the plaster under the wallpaper is in good condition.
- I. Screening. Whenever necessary for the health of the occupants, or for the proper sanitation or cleanliness of any building, acceptable mosquito screening shall be provided for each exterior door, window, or other opening in the exterior walls of the buildings.
- J. Garbage receptacle compartment. Every residential building shall be provided with facilities adequate for the storing of all garbage and waste, either within an approved compartment or receptacles. These facilities shall be maintained in a clean and sanitary condition.
- K. Fences. All fences shall be maintained in good repair and shall be kept straight, uniform and structurally sound. Wooden fences shall be either painted or stained or otherwise treated or sealed in an approved manner to prevent their becoming a nuisance from weathering or deterioration.
- L. Sanitation. Each room, hallway, passageway, stairway, wall, partition, ceiling, floor, skylight, glass window, door carpet, rug, matting, window curtain, water closet, compartment, or room, toilet room, bathroom, slop sink room, washroom, plumbing fixtures, drain, roof, closet, cellar, basement, yard, court, lot and the premises of every building shall be kept in every part clean,

sanitary, and free from all accumulation of debris, abandoned or inoperable motor vehicles and vehicle parts, filth, rubbish, garbage, rodents, insects and other vermin, excessive vegetation and other offensive matter.

- M. Dangerous articles. No article that is dangerous or detrimental to life or to the health of the occupants, including any feed, hay, straw, excelsior, cotton, paper stock, rags, junk, or any other material that may create a fire hazard, shall be kept, stored or handled in any part of a dwelling, apartment house or hotel, or on the lot on which such building is located.
- N. Caretaker. A janitor, housekeeper, or other responsible person shall reside upon the premises and shall have charge of every apartment house in which there are sixteen (16) or more apartments, of every hotel in which there are twelve (12) or more guest rooms, unless the owner of any such apartment house or hotel resides upon said premises. If the owner does not reside upon the premises of any apartment house in which there are more than four (4) but less than sixteen (16) apartments, a notice stating the owner's name and address or the name and address of his agent in charge of the apartment house shall be posted in a conspicuous place on the premises.
- O. Bedding. In every apartment house or hotel, every part of every bed, including mattress, sheets, blankets, and bedding, shall be kept in a clean, dry and sanitary condition, free from filth, urine or other foul matters, and from the infection of lice, bedbugs or other insects. The bed linen of a bed in a hotel shall be changed at least as often as a new guest occupies the bed.

CHAPTER 18.46 ENERGY CODE

18.46.010 – Adoption.

18.46.020 – Application.

CHAPTER 18.46 ENERGY CODE

18.46.010 – Adoption.

The City Council adopts and incorporates by reference as though set forth in full in this chapter the 2013 Edition of the California Building Energy Efficiency Standards. The California Building Energy Efficiency Standards is Part 6 of the California Code of Regulations, Title 24, also referred to as the California Building Standards Code. This part is developed by the California Energy Commission.

The adoption of the 2013 Edition of the California Building Energy Efficiency Standards (herein referred to as “California Energy Code” and certain provisions of the Long Beach Municipal Code shall remain in full force and effect as provided in this title. Such codes and code provisions shall constitute and be known as the Long Beach Energy Code. A copy of the California Energy Code, printed as code in book form, shall be on file in the office of the City Clerk.

18.46.020 – Application.

The provisions of the California Energy Code are applicable to all occupancy groups and uses regulated by Section 100.0 of Subchapter 1 of said code. The Building and Safety Bureau enforce those provisions made by the California Energy Commission (CEC).

CHAPTER 18.47 GREEN BUILDING STANDARDS CODE

18.47.010 – Adoption.

18.47.020 – Application.

18.47.030 – Amendments to the adopted code.

18.47.040 – Sections, chapters or appendices deleted from adopted code.

18.47.050 – Amend CGBSC Section 4.408—Construction and demolition recycling program.

18.47.060 – Amend CGBSC Section 5.408—Construction and demolition recycling program.

CHAPTER 18.47 GREEN BUILDING STANDARDS CODE

18.47.010 – Adoption.

The City Council adopts and incorporates by reference as though set forth in full in this chapter the 2013 Edition of the California Green Building Standards Code, excluding sections, chapters or appendices pursuant to Section 18.47.040. The California Green Building Standards Code is Part 11 of the California Code of Regulations, Title 24, also referred to as the California Building Standards Code.

The adoption of the 2013 Edition of the California Green Building Standards Code (herein referred to as “California Green Building Standards Code”) is subject to the changes, amendments and modifications to said code as provided in this chapter, and certain provisions of the Long Beach Municipal Code, which shall remain in full force and effect as provided in this title. Such codes and code provisions shall constitute and be known as the Long Beach Green Building Standards Code. A copy of the California Green Building Standards Code, printed as code in book form, shall be on file in the office of the City Clerk.

18.47.020 – Application.

The provisions of the California Green Building Standards Code are applicable only to those occupancies or uses that the State agency making the amendments is authorized to regulate, as listed in Chapter 1 of the California Green Building Standards Code. The Building and Safety Bureau shall only enforce those amendments made by the following State agencies:

- A. The Building Standards Commission as specified in Section 103.1 of the California Green Building Standards Code.
- B. The Department of Housing and Community Development (HCD) as specified in Section 104.1 of the California Green Building Standards Code.

18.47.030 – Amendments to the adopted code.

The California Green Building Standards Code is amended and modified as set forth in Sections 18.47.040 through 18.47.060.

18.47.040 – Sections, chapters or appendices deleted from the adopted code.

The following sections, chapters or appendices of the California Green Building Standards Code are deleted: Appendices A4, A5, and A6.1.

18.47.050 – Amend CGBSC Section 4.408—Construction and demolition recycling program.

Section 4.408 of the 2013 Edition of the California Green Building Standards Code is deleted in its entirety and replaced to read as follows:

SECTION 4.408 CONSTRUCTION AND DEMOLITION RECYCLING PROGRAM

4.408.1 General. Covered projects meeting the threshold of Section 18.67.020 of Title 18 of the Long Beach Municipal Code shall comply with Chapter 18.67 Construction and Demolition Recycling Program of Title 18 of the Long Beach Municipal Code.

18.47.060 – Amend CGBSC Section 5.408—Construction and demolition recycling program.

Section 5.408 of the 2013 Edition of the California Green Building Standards Code is deleted in its entirety and replaced to read as follows:

SECTION 5.408
CONSTRUCTION AND DEMOLITION RECYCLING PROGRAM

5.408.1 General. Covered projects meeting the threshold of Section 18.67.020 of Title 18 of the Long Beach Municipal Code shall comply with Chapter 18.67 Construction and Demolition Recycling Program of Title 18 of the Long Beach Municipal Code.

CHAPTER 18.48 FIRE CODE

- 18.48.010 – Adoption.
- 18.48.020 – Application.
- 18.48.030 – Amendments to the adopted codes.
- 18.48.040 – Deleted phrases and sections.
- 18.48.050 – CFC Chapter 1, Section 101.1—Title.
- 18.48.060 – CFC Chapter 1, Section 101.2—Scope.
- 18.48.070 – CFC Chapter 1, Section 101.2—Scope.
- 18.48.080 – CFC Chapter 1, Section 103.2—Appointment.
- 18.48.090 – CFC Chapter 1, Section 104.3—Right of entry.
- 18.48.100 – CFC Chapter 1, Section 104.6—Official records.
- 18.48.110 – CFC Chapter 1, Section 105.1.2—Types of permits.
- 18.48.120 – CFC Chapter 1, Section 105.1.2—Types of permits.
- 18.48.130 – CFC Chapter 1, Section 105.2—Application.
- 18.48.140 – CFC Chapter 1, Section 105.3.1—Expiration.
- 18.48.150 – CFC Chapter 1, Section 105.6—Required operational permits.
- 18.48.160 – CFC Chapter 1, Section 105.6—Required operational permits.
- 18.48.170 – CFC Chapter 1, Section 105.6.14 – Explosives.
- 18.48.180 – CFC Chapter 1, Section 105.7—Required construction permits.
- 18.48.190 – CFC Chapter 1, Section 105.7—Required construction and inspection permits.
- 18.48.200 – CFC Chapter 1, Section 107.5—Overcrowding.
- 18.48.210 – CFC Chapter 1, Section 109.4—Violation penalties.
- 18.48.220 – CFC Chapter 1, Section 111.4—Failure to comply.
- 18.48.230 – CFC Chapter 1, Section 113.2—Fees.
- 18.48.240 – CFC Chapter 1—Administration.
- 18.48.250 – CFC Chapter 2, Section 202—General definitions.
- 18.48.260 – CFC Chapter 2, Section 202—General definitions.
- 18.48.270 – CFC Chapter 2, Section 202—General definitions.
- 18.48.280 – CFC Chapter 3, Section 304.1—Waste accumulation prohibited.
- 18.48.290 – CFC Chapter 3, Section 307.1.1—Prohibited open burning.
- 18.48.300 – CFC Chapter 3, Section 307.4.2—General.
- 18.48.310 – CFC Chapter 3, Section 312.2—Posts.
- 18.48.320 – CFC Chapter 4, Section 403 – Public Assemblages and Events.
- 18.48.330 – CFC Chapter 5, Section 503.2.1—Dimensions.
- 18.48.340 – CFC Chapter 5, Section 503.2.4—Turning radius.
- 18.48.350 – CFC Chapter 5, Section 505.1—Address numbers.
- 18.48.360 – CFC Chapter 5, Section 506.1—Where required.
- 18.48.370 – CFC Chapter 5—Fire Service Features.
- 18.48.380 – CFC Chapter 9, Section 901.4—General.
- 18.48.390 – CFC Chapter 9, Section 901.4.2 – Nonrequired fire protection systems.
- 18.48.400 – CFC Chapter 9, Section 901.4.3 – Fire areas.
- 18.48.410 – CFC Chapter 9, Section 903.1—General.
- 18.48.420 – CFC Chapter 9, Section 903.2—Where required.
- 18.48.430 – CFC Chapter 9, Section 903.2.8—Group R.
- 18.48.440 – CFC Chapter 9, Section 903.3.5—Water supplies.
- 18.48.450 – CFC Chapter 9, Section 903.4 – Sprinkler system supervision and alarms.
- 18.48.460 – CFC Chapter 9, Section 903.4.1—Monitoring.
- 18.48.470 – CFC Chapter 9, Section 903.4.2—Alarms.
- 18.48.480 – CFC Chapter 9, Section 903.4.2—Alarms.
- 18.48.490 – CFC Chapter 9, Section 905.1—General.
- 18.48.500 – CFC Chapter 9, Section 905.4 (1) – Location of Class I standpipe hose connection.
- 18.48.510 – CFC Chapter 9, Section 907.1—General.
- 18.48.520 – CFC Chapter 9, Section 907.3.1 – Duct smoke detectors.
- 18.48.530 – CFC Chapter 9, Section 907.3.1 Exception 2– Duct smoke detectors.
- 18.48.540 – CFC Chapter 9, Section 907—Fire alarm and detection systems.
- 18.48.550 – CFC Chapter 9, Section 910.3.2.2—Sprinklered buildings.

- 18.48.560 – CFC Chapter 9, Section 912.1—Installation.
 - 18.48.570 – CFC Chapter 9, Section 912.2.1—Visible location.
 - 18.48.580 – CFC Chapter 9, Section 912.3—Access.
 - 18.48.590 – CFC Chapter 10, Section 1003—General means of egress.
 - 18.48.600 – CFC Chapter 10, Section 1009.16—Stairway to roof.
 - 18.48.610 – CFC Chapter 10, Section 1009.16—Stairway to roof.
 - 18.48.620 – CFC Chapter 10, Section 1009.16—Stairway to roof.
 - 18.48.630 – CFC Chapter 10, Section 1028.12—Seat stability.
 - 18.48.640 – CFC Chapter 23, Section 2303.1.1—Protection of dispensing devices.
 - 18.48.650 – CFC Chapter 23, Section 2306.7.9.2—Vapor processing system.
 - 18.48.660 – CFC Chapter 35—Welding and other hot work.
 - 18.48.670 – CFC Chapter 36, Section 3604—Fire protection equipment.
 - 18.48.680 – CFC Chapter 48, Section 4807.1—Fire safety officers.
 - 18.48.690 – CFC Chapter 56, Section 5601—General.
 - 18.48.700 – CFC Chapter 56, Section 5608—Fireworks Display.
 - 18.48.710 – CFC Chapter 57, Section 5704.2.11.3—Depth and cover.
 - 18.48.720 – CFC Chapter 57, Section 5705.3.5.2—Occupancy quantity limits.
 - 18.48.730 – CFC Chapter 61, Section 6101—General.
 - 18.48.740 – CFC Chapter 61, Section 6103.2.2—Industrial vehicles and floor maintenance machines.
 - 750 – CFC Chapter 61, Section 6104.3—Container location.
- .
- 18.48.760 – CFC Chapter 61, Section 6101.3 – Construction documents.
 - 18.48.770 – CFC Appendix Chapter B, Section B105.2—Buildings other than one- and two-family dwellings.

CHAPTER 18.48 FIRE CODE

18.48.010 – Adoption.

The City Council adopts and incorporates by reference as though set forth in full in this chapter The 2013 Edition of the California Fire Code (CFC), excluding sections, chapters or appendices pursuant to Section 18.48.040. The California Fire Code is Part 9 of the California Code of Regulations, Title 24, also referred to as the California Building Standards Code. This part is based on the provisions of the 2012 International Fire Code (model code—IFC) as developed by the International Code Council with necessary California amendments.

The adoption of the 2013 Edition of the California Fire Code (herein referred to as the “California Fire Code”) is subject to the changes, amendments and modifications to said code as provided in this chapter, and certain provisions of the Long Beach Municipal Code, which shall remain in full force and effect as provided in this title. Such codes and code provisions shall constitute and be known as the Long Beach Fire Code. A copy of the California Fire Code, printed as code in book form, shall be on file in the office of the City Clerk.

Notwithstanding the provisions of the above referenced Fire Code(s), all new or increased fees for services provided pursuant to the Fire Code(s) shall not take effect until a resolution for such fees is adopted by the City Council pursuant to California Government Code Sections 66016 and 66020.

18.48.020 – Application.

The provisions of the model code (the International Fire Code), which are incorporated into the California Fire Code, are applicable to all occupancy groups and uses regulated by the model code. The amendments made by the State agencies to the model code and incorporated into the California Fire Code are applicable only to those occupancies or uses that the State agency making the amendments is authorized to regulate, as listed in Chapter 1 of the California Building Code adopted in Chapter 18.40. The Fire Prevention Bureau shall only enforce those amendments made by the following State agencies:

- A. The Office of the State Fire Marshal (SFM) as specified in Section 1.11 of the California Fire Code.

18.48.030 – Amendments to the adopted codes.

The California Fire Code is amended and modified as set forth in Sections 18.48.040 through 18.48.770.

18.48.040 – Deleted phrases and sections.

The following phrases or sections are deleted from the California Fire Code, 2010 Edition:

CFC & IFC 108	Delete section.
CFC & IFC 308.1.4	Delete section.
CFC & IFC 308.1.6.2	Delete exception 4.
CFC & IFC 308.1.7	Delete section.
CFC & IFC 308.2	Delete exception 2.
CFC & IFC 308.3	Delete section.
CFC & IFC 311.2.2	Delete exceptions 1 and 2.
CFC & IFC Chapter 4	Delete entire chapter, except for those sections adopted by the SFM.
CFC & IFC 510.2	Delete section

CFC & IFC 805 Delete section

CFC & IFC 806	Delete section, except where adopted by the SFM.
CFC & IFC 807	Delete section, except where adopted by the SFM.
CFC & IFC 808	Delete section.
CFC & IFC 901.4.2	Delete the words “partial or”.
CFC & IFC 903.4	Delete exceptions 4 and 5.
CFC & IFC 907.2.7.1	Delete section.
CFC & IFC 907.3.1	Delete exception 1.
CFC & IFC 913.4	Delete methods 3 and 4.
CFC & IFC Chapter 11	Delete entire chapter, except for those sections adopted by the SFM.
CFC & IFC Chapter 26	Delete entire chapter.
CFC & IFC 2701.1	Delete exception 8.
.	.
CFC & IFC Appendix A	Delete entire appendix. CFC & IFC Appendix D Delete entire appendix.
CFC & IFC Appendix E	Delete entire appendix.
CFC & IFC Appendix F	Delete entire appendix.
CFC & IFC Appendix G	Delete entire appendix.
CFC & IFC Appendix I	Delete entire appendix. I
CFC & IFC Appendix J	Delete entire appendix.
CFC & IFC Appendix K	Delete entire appendix.

18.48.050 – CFC Chapter 1, Section 101.1—Title.

Section 101.1 of Chapter 1 of the California Fire Code is amended to read:

101.1 Title. These regulations shall be known as the Fire Code of the City of Long Beach, hereinafter referred to as” this code”.

18.48.060 – CFC Chapter 1, Section 101.2—Scope.

Section 101.2 of Chapter 1 of the California Fire Code is amended by the addition of Subsection 6 to read:

6. The maintenance of fire protection and elimination of fire hazards on vessels moored, anchored, or berthed in waters under the jurisdiction of the City and/or within the boundaries of the Port of Long Beach.

18.48.070 – CFC Chapter 1, Section 101.2—Scope.

Section 101.2 of Chapter 1 of the California Fire Code is amended by the addition of Section 101.2.2 to read:

101.2.2 Supplemental rules and regulations. The Fire Code Official is authorized to make and enforce such rules and regulations for the prevention and control of fires, fire hazards and hazardous materials incidents as may be necessary from time to time to carry out the intent of this code. Three certified copies of such rules and regulations shall be filed with the City Clerk and shall take effect immediately thereafter. Additional copies shall be kept in the Fire Prevention Bureau Office. These rules and regulations shall be known as the Fire Prevention Requirements.

18.48.080 – CFC Chapter 1, Section 103.2—Appointment.

Section 103.2 of Chapter 1 of the California Fire Code is amended to read:

103.2 Appointment. The fire code official shall be appointed by the Fire Chief of the City of Long Beach; and the fire code official shall not be removed from office except for cause and after full opportunity to be heard on specific and relevant charges by and before the Fire Chief.

18.48.090 – CFC Chapter 1, Section 104.3—Right of entry.

Section 104.3 of Chapter 1 of the California Fire Code is amended by the addition of the following paragraph to read:

The Fire Code Official shall have the authority to direct inspection and insure compliance with the Long Beach Fire Code on all tankers and vessels at anchor or dockside in waters under the jurisdiction of the City and/or within the boundaries of the Port of Long Beach. All vessels shall comply with rules and regulations set forth in federal, State and local codes. Access to vessels shall be maintained at all times while the vessel is at anchor or dockside by use of proper brows or accommodation ladders.

18.48.100 – CFC Chapter 1, Section 104.6—Official records.

Section 104.6 of Chapter 1 of the California Fire Code is amended to read:

104.6 Official records. The Fire Code Official shall keep official records as required by Sections 104.6.1 through 104.6.4. Such official records shall be retained for not less than three years or for as long as the activity to which such records relate remains in existence, unless otherwise provided by other regulations.

18.48.110 – CFC Chapter 1, Section 105.1.2—Types of permits.

Section 105.1.2 of Chapter 1 of the California Fire Code is amended by revising the first sentence to read:

105.1.2 Types of permits. There shall be three types of permits as follows:

18.48.120 – CFC Chapter 1, Section 105.1.2—Types of permits.

Section 105.1.2 of Chapter 1 of the California Fire Code is amended by the addition of subsection 3 to read:

3. Inspection permit. An inspection permit allows the applicant to construct, enlarge, alter, repair, move, demolish, or change the occupancy of a building or structure, fire access roadways, smoke control systems, high piled storage, hazardous materials when not in “H” occupancies, and special systems as indicated in Section 18.48.560 of this code.

18.48.130 – CFC Chapter 1, Section 105.2—Application.

Section 105.2 of Chapter 1 of the California Fire Code is amended by the addition of Subsection 105.2.5 to read:

105.2.5 Declaration of intended use of occupancy. As required by the Fire Code Official, any or all owners of any occupancy may be required to record with the County Recorder of the County of Los Angeles a legal instrument of intended use. This legal instrument shall be called a Declaration of Intended Use, which shall specifically state by occupancy classification designations all intended uses of all portions of the occupancy and may not be modified or withdrawn without the approval of the Fire Code Official. Unapproved changes of occupancy or use can be cause for an immediate hearing before the Building Official and the Fire Code Official or their designees. Such hearing shall be conducted to rule on the revocation of the Certificate of Occupancy and the revocation of all permits issued to all owners, tenants, operators and occupants of all portions of the occupancy. The Declaration of Intended Use shall be binding on all present and future owners, tenants, operators and occupants.

105.2.5.1 Existing occupancy modification. Any existing occupancy that is modified in any manner where the modifications exceed 1% of the total floor area of the smallest aggregate individual floor area or tier area in any twelve month period, shall require the filing of a Declaration of Intended Use.

105.2.5.2 Filing. A certified copy of the recorded Declaration of Intended Use shall be filed with the Building Official and the Fire Code Official before any Certificate of Occupancy and/or any permits are issued to any or all owners, operators or occupants of the occupancy.

18.48.140 – CFC Chapter 1, Section 105.3.1—Expiration.

Section 105.3.1 of Chapter 1 of the California Fire Code is amended to read:

105.3.1 Expiration. Every construction and inspection permit issued shall be valid for a period of two (2) years from the date after its issuance; provided however that every permit issued shall expire on the one-hundred eightieth (180th) day after its issuance if the work on the site authorized by such permit has not commenced or has not been inspected; or shall expire whenever the Fire Code Official determines the work authorized by such permit has been suspended, discontinued or abandoned or has not been inspected for a continuous period of one hundred and eighty (180) days after the time the work has commenced.

18.48.150 – CFC Chapter 1, Section 105.6—Required operational permits.

Section 105.6 of Chapter 1 of the California Fire Code is amended to read:

105.6 Required operational permits. The Fire Code Official is authorized to issue operational permits for the operations set forth in Chapter 1, Sections 105.6.1 through 105.6.61.

18.48.160 – CFC Chapter 1, Section 105.6—Required operational permits.

Section 105.6 of Chapter 1 of the California Fire Code is amended by the addition of Sections 105.6.48 through 105.6.61 to read:

105.6.48 Airport, heliport and helistop. An operational permit is required to operate an airport, heliport and helistop.

105.6.49 Battery systems. An operational permit is required to operate stationary lead-acid battery systems having a liquid capacity greater than 50 gallons.

105.6.50 Bulk storage facility. Above ground bulk storage of flammable and combustible liquids for each 225,000 BBL or major fraction thereof.

105.6.51 Educational occupancy. An operational permit is required to operate any occupancy classified as E and E-Daycare in all commercial properties. Also in residential properties with more than 8 children.

105.6.52 Flammable and combustible liquids. Outside above ground storage of flammable and combustible liquids, more than 60 gallons, for each 6,000 gallons or major fraction thereof.

105.6.53 General use permit. An operational permit is required to maintain, store, use or handle materials, or to conduct processes which may produce conditions hazardous to life or property, or to install equipment used in connection with such processes, or to carry on any activity which in the opinion of the Fire Code Official may be hazardous to life and property and which is not specifically covered by Section 105.6

105.6.54 High-rise. An operational permit is required to operate any high-rise structure.

105.6.55 Hot air balloon. An operational permit is required to launch any hot air balloon which has its lifting power provided by an open flame device. A plan shall be submitted for approval showing distances from buildings and other possible hazards, as determined by the Fire Code Official, before the permit is issued.

105.6.56 Institutional occupancy. An operational permit is required to operate any occupancy with over 6 occupants classified as an I-1, I-2, I-3 or any R occupancy providing care.

105.6.57 Marine service station. An operational permit is required to operate a marine service station.

105.6.58 Radioactive material. An operational permit is required to store or handle radioactive materials.

105.6.59 Recreational fire. An operational permit is required for a recreational fire.

105.6.60 Residential occupancy. An operational permit is required to operate a residential occupancy with three or more units.

Exception. High-rise. See Section 105.6.55.

105.6.61 Rifle range. An operational permit is required to operate a rifle range.

18.48.170 – CFC Chapter 1, Section 105.6.14—Explosives.

Section 105.6.14 Exception, of Chapter 1 of the California Fire Code is amended by replacing “Section 5606” with “Chapter 56”.

18.48.180 – CFC Chapter 1, Section 105.7—Required construction permits.

Section 105.7 of Chapter 1 of the California Fire Code is amended to read:

105.7 Required construction and inspection permits. The Fire Code Official is authorized to issue construction and inspection permits for work as set forth in Chapter 1, Sections 105.7.1 through 105.7.21.

18.48.190 – CFC Chapter 1, Section 105.7—Required construction and inspection permits.

Section 105.7 of Chapter 1 of the California Fire Code is amended by the addition of Sections 105.7.17 through 105.7.23 to read:

105.7.17 Buildings and structures. An inspection permit is required to construct, enlarge, alter, repair, move, demolish, or change the occupancy of a building or structure.

105.7.18 Automatic sprinkler systems. A construction permit is required for the installation or modification of an automatic sprinkler system, including all interior and exterior piping, valves, or appurtenances. Maintenance performed in accordance with this code is not considered a modification and does not require a permit.

105.7.19 Smoke control system. An inspection permit is required for the installation or modification of a smoke control system. Maintenance performed in accordance with this code is not considered a modification and does not require a permit.

105.7.20 Fire Department emergency access and building emergency egress. A construction permit is required for the construction or modification of a Fire Department emergency access and building emergency egress.

105.7.21 High piled storage. A construction permit is required for the construction or modification of a high piled storage area inside, or outside of any building or structure.

105.7.22 Hazardous materials, when not in “H” occupancies. A construction permit is required for the installation or modification of a hazardous material, when not in “H” Occupancies.

105.7.23 Special systems. A construction permit is required for the construction or modification of vapor recovery systems, dust collection systems, compressed or liquefied gas manifolds, and other special systems requiring Fire Department approvals.

18.48.200 – CFC Chapter 1, Section 107.5—Overcrowding.

Section 107.5 of Chapter 1 of the California Fire Code is amended by the addition of Section 107.5.1 to read:

107.5.1 Occupant count. The supervisor of each place of assembly shall have an effective system to keep count of the number of occupants present in the assembly area. If at any time, the Fire Code Official determines that an accurate count of occupants is not being maintained, the occupancy shall be cleared until an accurate count can be made.

18.48.210 – CFC Chapter 1, Section 109.4—Violation penalties.

Section 109.4 of Chapter 1 of the California Fire Code is amended to read:

109.4 Violation penalties. Persons who shall violate a provision of this code or shall fail to comply with any of the requirements thereof or who shall erect, install, alter, repair or do work in violation of the approved construction documents or directive of the Fire Code Official, or of a permit or certificate used under the provisions of this code, or who enters a building that has been declared "unsafe" and ordered "evacuated", shall be guilty of a misdemeanor .

A person is guilty of a separate offense each day during which he or she commits, continues, or permits a violation of any provision of, or any order, rule, or regulation made pursuant to, this chapter.

18.48.220 – CFC Chapter 1, Section 111.4—Failure to comply.

Section 111.4 of Chapter 1 of the California Fire Code is amended to read:

111.4 Failure to comply. Any person who shall continue any work after having been served with a stop work order, except such work as that person is directed to perform to remove a violation or unsafe condition, shall be guilty of a misdemeanor .

A person is guilty of a separate offense each day during which he or she commits, continues, or permits a violation of any provision of, or any order, rule, or regulation made pursuant to, this chapter.

18.48.230 – CFC Chapter 1, Section 113.2—Fees.

Section 113 of Chapter 1 of the California Fire Code is amended by the addition of Sections 113.6, 113.7 and 113.8 to read:

113.6 Operational permit fees. The fee set forth and established for the particular activity by a resolution of the City Council shall accompany all operational permits required pursuant to the provisions of this code.

113.7 Construction and inspection permit fees. Construction and inspection permit fees shall be paid at the time of the permit issuance. In addition to the permit fee, the applicant shall pay a plan check fee. The fee set forth and established for the particular activity by a resolution of the City Council shall accompany all construction and inspection permits required pursuant to the provisions of this code.

113.8 Reinspection fee. When the Fire Code Official or his representative arrives at an occupancy to inspect for compliance with a written order or notice and is prevented from making the inspection due to inaccessibility of the area, or finds that compliance with the written order has not been made or other circumstances, or when an inspection is scheduled for operational or construction permits and

the permittee is not ready for inspection and does not inform the Fire Code Official or his representative two hours prior to the scheduled inspection, a reinspection fee may be assessed.

18.48.240 – CFC Chapter 1—Administration.

Chapter 1 of the California Fire Code is amended by the addition of Section 114 to read:

SECTION 114 – RESPONSIBILITY

114.1 Responsibility for costs. Persons who personally or through another willfully, negligently, or in violation of law set a fire, allow a fire to be set, allow a fire kindled or attended by them to escape from their control, allow any hazardous materials to escape from their control, neglect to properly comply with any written notice of the Fire Code Official, or willfully or negligently allow the continuation of a violation of this code and amendments thereto are liable for the expenses of fighting the fire, for the expenses of any investigation, or for the expenses incurred during a hazardous materials incident. Such expenses shall be a charge against that person. Such charge shall constitute a debt of such person, and is collectible by the City in the same manner as in the case of an obligation under a contract, expressed or implied and a lien may be attached to the involved property.

114.2 Reporting injuries caused by fires. Any person, firm, corporation, or agency that maintains a hospital, pharmacy, or any other medical or first aid service shall immediately report to the Fire Code Official any person suffering from any fire-related injury. The report shall be made both by telephone and in writing, and shall include the name and address of the injured person, the person's whereabouts, and the character and extent of the person's injuries.

18.48.250 – CFC Chapter 2, Section 202—General definitions.

Section 202 of Chapter 2 of the California Fire Code high-rise structure definition, Subsection 2 is amended to read:

"High-rise structure" means every building of any type of construction or occupancy having floors used for human occupancy located more than seventy five (75) feet above the lowest floor level having building access (see California Building Code, Section 403) or the lowest level of Fire Department vehicle access, whichever is more restrictive, except buildings used as hospitals as defined in Section 1250 of the California Health and Safety Code.

18.48.260 – CFC Chapter 2, Section 202—General definitions.

Section 202 of Chapter 2 of the California Fire Code is amended by revising the following definitions to read:

Fire Chief. The chief officer of the fire department serving the jurisdiction.

Fire Code Official. The fire marshal or his or her designated representatives.

18.48.270 – CFC Chapter 2, Section 202—General definitions.

Section 202 of Chapter 2 of the California Fire Code is amended by adding the following definitions to read:

Boat Yard. A facility for construction, repair, storage, launching, berthing, and fueling of small craft.

Small Craft. Vessels under sixty-five (65) feet in length.

18.48.280 – CFC Chapter 3, Section 304.1—Waste accumulation prohibited

Section 304.1 of Chapter 3 of the California Fire Code is amended by the addition of Section 304.1.4 to read:

304.1.4 Alleys to be kept clean. It shall be unlawful for any person owning or occupying or having possession or control of any property bordering on any public alley in the City to fail, refuse or neglect to keep the portion of such alley between the center line of the alley and the property line of such property free from garbage, debris, rubbish, combustible materials, flammable liquids, hazardous materials and other obstructions.

18.48.290 – CFC Chapter 3, Section 307.1.1—Prohibited open burning.

Section 307.1.1 of Chapter 3 of the California Fire Code is amended to read:

307.1.1 Prohibited open burning. Open burning shall be conducted in accordance with Section 307 and as required by other governing agencies regulating emissions. No person shall conduct open burning for any purposes except:

1. When such fire is set or permission for such fire is given in the performance of the official duty of any Public Safety Officer, and the fire in the opinion of such officer is necessary for the purpose of the prevention of a fire hazard which cannot be abated by any other means or for the purpose of the instruction of public employees in the methods of fighting fire.
2. When such fire is set on property used for industrial or institutional purposes to instruct employees in methods of fighting fire.
3. The Fire Code Official has issued an open burning permit allowing open burning for a specific purpose.

18.48.300 – CFC Chapter 3, Section 307.4.2—General.

Section 307.4.2 of Chapter 3 of the California Fire Code is amended by the addition of Section 307.4.2.1 to read:

307.4.2.1 General. Recreational fires shall be in accordance with Section 307. Recreational fires shall not be conducted unless the Fire Code Official has issued a permit permitting such fires. For recreational fires this permit shall be issued without cost.

18.48.310 – CFC Chapter 3, Section 312.2—Posts.

Section 312.2 of Chapter 3 of the California Fire Code is amended by the revision of Subsection (4) and the addition of Subsections (6) and (7) to read:

- (4) Set the top of the posts not less than 4 feet above ground.
- (6) Where heavy truck traffic is anticipated guard posts shall be a minimum of 6 inches in diameter, or as required by the Fire Code Official, concrete filled, located not less than 5 feet from the protected object, and have the tops of the posts not less than 4 feet above ground.
- (7) Guard posts shall be painted safety yellow.

18.48.320 – CFC Chapter 4, Section 403—Public Assemblages and Events.

Section 403 of Chapter 4 of the California Fire Code is amended by the addition of Section 403.4 to read:

403.4 Fire safety officer. When in the opinion of the Fire Code Official a place of assembly or any other place where people congregate, because of the number of persons, or nature of performance, exhibition, display, contest or activity or any other type of activity the Fire Code Official determines it is essential for public safety, the owner, agent, lessee or responsible party shall pay for Long Beach Fire Department Fire Safety Officers to be present.

18.48.330 – CFC Chapter 5, Section 503.2.1—Dimensions.

Section 503.2.1 of Chapter 5 of the California Fire Code is amended to read:

503.2.1 Dimensions. Fire apparatus access roads shall have an unobstructed width of not less than 26 feet, and an unobstructed vertical clearance of 15 feet.

18.48.340 – CFC Chapter 5, Section 503.2.4—Turning radius.

Section 503.2.4 of Chapter 5 of the California Fire Code is amended to read:

503.2.4 Turning radius. Fire apparatus access roads shall have a minimum inside turning radius of 28 feet.

18.48.350 – CFC Chapter 5, Section 505.1—Address numbers.

Section 505.1 of Chapter 5 of the California Fire Code is amended by the addition of Sections 505.1.1 and 505.1.2 to read:

505.1.1 Rear address numbers. All buildings on the property of the Long Beach Airport, and all multi-tenant buildings within the City, shall be provided with address numbers and/or suite numbers on the rear doors to each tenant space.

505.1.2 Address illumination. Address numbers on the street or road frontage of the building, shall be internally or externally illuminated. In addition, buildings on the Long Beach Airport property shall have the rear address numbers internally or externally illuminated, in addition to the street or road frontage addresses.

18.48.360 – CFC Chapter 5, Section 506.1—Where required.

Section 506.1 of Chapter 5 of the California Fire Code is amended by the addition of Sections 506.1.3 and 506.1.4 to read:

506.1.3 Identification. When required, keys shall be clearly tagged as to the area and/or location they serve and a minimum of three separate sets shall be located within the key box.

506.1.4 Gates. Vehicular or pedestrian gates obstructing required fire access shall be provided with locking devices and/or over-ride mechanisms, which have been approved by the Fire Code Official of the City of Long Beach.

18.48.370 – CFC Chapter 5—Fire Service Features.

Chapter 5 of the California Fire Code is amended by the addition of Section 511 to read:

SECTION 511 – EMERGENCY HELICOPTER LANDING FACILITY

511.1 General. Each high-rise building shall have an emergency helicopter landing facility located on the roof of the building in an area approved by the Fire Department. The landing facility shall be for emergency operations only and installed in accordance with Section 511.

511.2 Approaches. A landing glide slope angle determined by a ratio of eight feet horizontal distance for every one foot of vertical clearance is required. Two such approaches shall be available at least ninety degrees removed from each other.

511.3 Landing and takeoff area. A clear, unobstructed landing and takeoff area is required with a minimum dimension of one hundred feet by one hundred feet and a touchdown area having a minimum dimension of fifty feet by fifty feet.

511.4 Roof perimeter. If the roof has no parapet wall, a substantial fence or safety net shall be provided around the perimeter of the roof in such a manner that it will not restrict or reduce the required landing and takeoff area.

511.5 Wind device. An approved wind-indicating device shall be provided.

511.6 Standpipe. A Class II wet standpipe shall be provided and located in such a manner that it will not restrict or reduce the required landing and takeoff area.

511.7 Marking. The rooftop shall be marked by an emergency marker as required by the Fire Code Official.

511.8 Communication system. An extension of the building's emergency communication system shall extend to the roof, and shall consist of a head set and microphone in a cabinet.

18.48.380 – CFC Chapter 9, Section 901.4—General.

Section 901.4 of Chapter 9 of the California Fire Code is amended by the addition of Section 901.4.5 to read:

901.4.5 Protection of fire protection systems and equipment. Fire protection systems and equipment subject to possible vehicular damage shall be adequately protected with guard posts in accordance with Section 312 Vehicle Impact Protection, and modifications adopted under this code.

18.48.390 – CFC Chapter 9, Section 901.4.2—Nonrequired fire protection systems.

Section 901.4.2 of Chapter 9 of the California Fire Code is amended to read:

901.4.2 Nonrequired fire protection systems. Any fire protection system not required by this code or the California Building Code shall be furnished for complete protection and meet all requirements of this code and the California Building Code.

18.48.400 – CFC Chapter 9, Section 901.4.3—Fire areas.

Section 901.4.3 of Chapter 9 of the California Fire Code is amended to read:

901.4.3 Fire areas. The total fire area of buildings for this section shall be computed without regard to fire barriers and floors of less than four-hour fire resistive construction without openings.

18.48.410 – CFC Chapter 9, Section 903.1—General.

Section 903.1 of Chapter 9 of the California Fire Code is amended by the addition of Sections 903.1.2 through 903.1.4 to read:

903.1.2 Control valves. Fire Sprinkler system control valves shall be located within stairway number 1, and at the discretion of the Fire Code Official, shall be provided on all levels of buildings above or below grade.

903.1.3 Existing buildings. An automatic sprinkler system shall be installed in all existing occupancies as required by this section, if any of the following occurs:

1. There is a change in occupancy classification to one that would require an automatic sprinkler system per the Fire Code in the new occupancy.
2. The Fire Code Official determines that an automatic sprinkler system is required to provide a minimum level of public safety.

903.1.4 Partial automatic sprinkler systems. Partial automatic sprinkler systems are not allowed. Where automatic sprinkler systems are required to be installed by this section, or by any other sections in this code, or any nationally recognized standards, or are electively installed, the automatic sprinkler system shall be installed throughout the entire building, unless a four-hour fire resistive constructed wall, with no openings, separates the areas.

18.48.420 – CFC Chapter 9, Section 903.2—Where required.

Section 903.2 of Chapter 9 of the California Fire Code is amended by the addition of the following paragraph to read:

All new commercial, industrial and non-residential buildings that require two or more exits or that are greater than 3,000 sq. ft. shall be protected by an automatic sprinkler system. This shall not apply to existing buildings.

18.48.430 – CFC Chapter 9, Section 903.2.8—Group R.

Section 903.2.8 of Chapter 9 of the California Fire Code is amended by the addition of the following paragraphs to read:

All new multi-family (3 or more units) residential, hotels, motels and similar buildings shall be protected by an automatic sprinkler system.

All new single-family dwellings and duplexes greater than 4,000 sq. ft., or more than two-stories in height shall be protected by an automatic sprinkler system.

18.48.440 – CFC Chapter 9, Section 903.3.5—Water supplies.

Section 903.3.5 of Chapter 9 of the California Fire Code is amended by the addition of Section 903.3.5.3 to read:

903.3.5.3 Hydraulic calculations margin. Fire protection system hydraulic calculations shall include a 10 percent safety margin between the available water supply and the required system supply.

18.48.450 – CFC Chapter 9, Section 903.4—Sprinkler system supervision and alarms.

Section 903.4 of Chapter 9 of the California Fire Code is amended by the addition of Section 903.4.4 to read:

903.4.4 Remote annunciator. A remote annunciator shall be provided at the main entrance, the first suite in a multi suite building, or in a location as approved by the fire code official. The remote annunciator shall have the capability to silence and reset the system via a key located in the Knox box, or other approved means.

18.48.460 – CFC Chapter 9, Section 903.4.1—Monitoring.

Section 903.4.1 of Chapter 9 of the California Fire Code is amended by the addition of Section 903.4.1.1 to read:

903.4.1.1 Signal reporting. All signals when automatically transmitted to the facilities noted in 903.4.1 and to the remote annunciator shall be transmitted with each devices specific location, type and address.

18.48.470 – CFC Chapter 9, Section 903.4.2—Alarms.

Section 903.4.2 of Chapter 9 of the California Fire Code is amended by the addition of the following sentence to read:

The exterior alarm device shall be a horn and strobe device, located on the address side of the building, closest to the location of the fire department connection.

18.48.480 – CFC Chapter 9, Section 903.4.2—Alarms.

Section 903.4.2 of Chapter 9 of the California Fire Code is amended by the addition of Sections 903.4.2.1 and 903.4.2.2 to read:

903.4.2.1 Alarms. At least one (1) additional horn and strobe device is required on the interior of a building at the main entrance or in a location as approved by the fire code official.

903.4.2.2 Manual pull station. At least one (1) manual pull station is required on the interior of a building at the main entrance or in a location as approved by the fire code official.

18.48.490 – CFC Chapter 9, Section 905.1—General.

Section 905.1 of Chapter 9 of the California Fire Code is amended by the addition of Section 905.1.1 to read:

905.1.1 Design. All standpipe systems, except Class II systems, shall be designed to deliver a minimum of 125 psi at the discharge of all standpipe outlets.

18.48.500 – CFC Chapter 9, Section 905.4 (1) —Location of Class I standpipe hose connection.

Section 905.4 (1) of Chapter 9 of the California Fire Code is amended to read:

1. In every required required stairway, a hose connection shall be provided for each floor level above or below grade. Hose connection shall be located at the floor landing of each floor, unless otherwise approved by the fire code official. See Section 909.20.3.2 for additional provisions in smokeroof enclosures.

18.48.510 – CFC Chapter 9, Section 907.1—General.

Section 907.1 of Chapter 9 of the California Fire Code is amended by the addition of Sections 907.1.6, 907.1.7 and 907.1.9 to read:

907.1.6 Voluntary. Any fire alarm system not required by this code or the California Building Code shall be furnished for complete protection and meet all requirements of this code and the California Building Code, unless approved by the fire code official.

907.1.7 Evacuation. Buildings over 3 stories may be required to provide building evacuation based on the floor of alarm, the floor above and the floor below, in lieu of a general alarm, at the discretion of the Fire Code Official.

907.1.8 Control panels. Fire alarm system control panels, including sprinkler monitoring panels, shall be utilized for connecting and supervising fire alarm and/or fire related equipment only. Security or similar devices shall not be connected to a fire alarm or sprinkler monitoring control panel. The use of control panels capable of this feature is subject to the following:

1. The owner of the facility where the panel is being installed shall provide an original letter, on company letterhead, to the Long Beach Fire Department stating that not now, nor in the future, will security or similar equipment be connected to the fire alarm or sprinkler monitoring control panel.
2. New and/or existing control panels installed after the adoption of this ordinance found to be in violation of this requirement shall be subject to corrective action, as determined by the Fire Code Official.

907.1.9 Remote annunciator. A remote annunciator shall be provided at the main entrance, the first suite in a multi suite building, or in a location as approved by the fire code official. The remote annunciator shall have the capability to silence and reset the system via a key located in the Knox box, or other approved means.

18.48.520 – CFC Chapter 9, Section 907.3.1 — Duct smoke detectors.

Section 907.3.1 of Chapter 9 of the California Fire Code is amended to read:

907.3.1 Duct smoke detectors. Smoke detectors installed in ducts shall be listed for the air velocity, temperature and humidity present in the duct. Duct smoke detectors shall be connected to the building's fire alarm system or sprinkler monitoring system, when one is installed. Activation of a duct smoke detector shall initiate a visible and audible supervisory signal at a constantly attended location and shall perform the intended fire safety function in accordance with this code and the California Mechanical Code. Duct smoke detectors shall not be used as a substitute for required open area detection.

18.48.530 – CFC Chapter 9, Section 907.3.1 Exception 2— Duct smoke detectors.

Section 907.3.1 Exception 2 of Chapter 9 of the California Fire Code is amended to read:

2 In occupancies not required to be equipped with a fire alarm or sprinkler monitoring system, actuation of a duct smoke detector shall activate a visible and and audible signal in an approved location. Duct smoke detector trouble condition shall activate a visible or audible signal in an approved location and shall be identified as an air duct detector trouble.

18.48.540 – CFC Chapter 9, Section 907—Fire alarm and detection systems.

Section 907 of Chapter 9 of the California Fire Code is amended by the addition of Sections 907.10 and 907.10.1 to read:

907.10 Fire alarm upgrade. All existing multi-family residential, hotels, motels and high-rise buildings shall upgrade the existing fire alarm system to current code, at the time of replacement of the existing non-functioning fire alarm control panel.

907.10.1 Firefighter smoke removal system. A natural or mechanical Fire Department approved ventilation system for the removal of products of combustion shall be provided above and below grade on every level, at the discretion of the Fire Code Official, and shall consist of one of the following:

1. Panels or windows in the exterior walls which can be opened remotely from an approved location other than the fire floor. Such venting facilities shall be provided at the rate of twenty square feet per lineal feet of exterior wall in each story and shall be distributed around the perimeter at not

more than fifty-foot intervals. Such windows or panels and their controls shall be clearly identified. Exception: When a complete automatic fire extinguishing system is installed, windows or panels manually openable from within the fire floor or approved fixed tempered glass may be used in lieu of the remotely operated openable panels and windows. Such windows shall be clearly identified and shall be of the size and spacing called for above.

2. When a complete and approved automatic fire extinguishing system is installed, the mechanical air-handling equipment may be designed to accomplish smoke removal. Under fire conditions, the return and exhaust air shall be moved directly to the outside without recirculation to other sections of the building. The air-handling system shall provide a minimum of one exhaust air change each ten minutes for the area involved.
3. The firefighter smoke exhaust panel shall be located at the main entrance to the building or as required by the Fire Code Official, and shall be permanently labeled "Fire Department Smoke Evacuation Use Only".
4. Any other design which will produce equivalent results as approved by the Fire Code Official.
5. Operation shall be by use of Knox key switch.

18.48.550 – CFC Chapter 9, Section 910.3.2.2—Sprinklered buildings.

Section 910.3.2.2 of Chapter 9 of the California Fire Code is amended by the addition of the following sentence to read:

Smoke and heat vents fusible links shall be designed at a minimum of 100 degrees above the temperature rating of the fire sprinklers.

18.48.560 – CFC Chapter 9, Section 912.1—Installation.

Section 912.1 of Chapter 9 of the California Fire Code is amended by the addition of Section 912.1.1 to read:

912.1.1 Design. Fire Department connections, where required, shall be provided with a minimum number of two (2) 2-1/2 inch inlets, regardless of the size of the fire sprinkler system. Where fire protection system demands are in excess of 1,000 gpm a minimum of four (4) 2-1/2 inch inlets shall be provided.

Hazardous locations, high-rise buildings or where fire protection system demands are in excess of 2,000 gpm, a second fire Department connection utilizing four (4) 2-1/2 inch inlets may be required at the discretion of the Fire Code Official.

18.48.570 – CFC Chapter 9, Section 912.2.1—Visible location.

Section 912.2.1 of Chapter 9 of the California Fire Code is amended by the addition of the following paragraph to read:

Fire Department connections shall be located on the address side of the building or structure and shall be within 150 feet of a public fire hydrant.

18.48.580 – CFC Chapter 9, Section 912.3—Access.

Section 912.3 of Chapter 9 of the California Fire Code is amended by the addition of the following paragraph to read:

Fire Department connections, where located in landscaping or other similar areas, shall be provided with a minimum 3-foot concrete pad around the Fire Department connection, and an approved concrete pathway leading to the Fire Department connection.

18.48.590 – CFC Chapter 10, Section 1003—General means of egress.

Section 1003 of Chapter 10 of the California Fire Code is amended by the addition of Section 1003.8 to read:

1003.8 Protection of means of egress. When the Fire Code Official determines that means of egress require protection from possible vehicular damage, crash posts shall be installed in accordance with Section 312 Vehicle Impact Protection.

18.48.600 – CFC Chapter 10, Section 1009.16—Stairway to roof.

Section 1009.16 of Chapter 10 of the California Fire Code is amended to read:

1009.16 Stairway to roof. In buildings located four or more stories in height above grade plane, one stairway shall extend to the roof surface, unless the roof has a slope steeper than four units vertical in 12 units horizontal (33-percent slope).

18.48.610 – CFC Chapter 10, Section 1009.16—Stairway to roof.

Section 1009.16 of Chapter 10 of the California Fire Code is amended by addition of Section 1009.16.1.1 to read:

1009.16.1.1 Ladder. A fixed ladder shall be provided for access to the hatch or trap door.

18.48.620 – CFC Chapter 10, Section 1009.16—Stairway to roof.

Section 1009.16 of Chapter 10 of the California Fire Code is amended by the addition of Section 1009.16.1.2 to read:

1009.16.1.2 Stairway 1. When a stairway to the roof is required it shall be designated Stairway 1.

18.48.630 – CFC Chapter 10, Section 1028.12—Seat stability.

Section 1028.12 of Chapter 10 of the California Fire Code is amended by the addition of the following paragraph to read:

This does not apply to temporary situations, such as, tents or temporary public assemblies.

18.48.640 – CFC Chapter 23, Section 2303.1.1—Protection of dispensing devices.

Section 2303.1.1 of Chapter 23 of the California Fire Code is amended by the addition of the following paragraph to read:

Dispensing devices shall be protected against physical damage from vehicles by mounting on a concrete island 6 inches or more in height or by other approved methods.

18.48.650 – CFC Chapter 23, Section 2306.7.9.2—Vapor processing system.

Section 2306.7.9.2 of Chapter 23 of the California Fire Code is amended by the addition of Sections 2306.7.9.2.5 through 2306.7.9.2.10 to read:

2306.7.9.2.5 Component design. If a component is likely to contain a flammable vapor/air mixture under operating conditions and can fail in a manner, which could ignite the mixture, the component

shall be designed to withstand an internal explosion without failure to the outside and protected to prevent flame propagation to other parts of the system.

2306.7.9.2.6 Fire checks. Approved fire checks or other positive means of automatic isolation of underground storage tanks shall be installed in vapor-return piping to prevent a flashback from reaching the underground tanks. Such devices also shall be installed in all vapor/air piping as close as practical to each burner or group of burners in a vapor incineration unit, and in all vapor-transfer piping as close as practical to refrigeration, absorption or similar types of processing equipment.

2306.7.9.2.7 Vent termination. Vents from vapor-processing units shall not be less than 12 feet above adjacent ground level and not less than 8 feet above the processing unit itself. Vent outlets shall be directed and located such that flammable vapors will not accumulate, travel to an unsafe location or enter buildings.

2306.7.9.2.8 Electrical equipment. Electrical equipment shall be in accordance with the California Electrical Code.

2306.7.9.2.9 Site control. Fences, bumper posts or other control measures shall be provided where necessary to protect from tampering, trespassing and vehicle traffic. The area within 15 feet of the installed vapor-processing unit shall be kept clear of combustible materials.

2306.7.9.2.10 Maintenance, tests and inspection. Vapor-recovery and vapor-processing equipment shall be subject to periodic maintenance, tests and inspections. Maintenance, tests and inspections set forth in the listing document, or other tests required by the Fire Code Official, shall be the responsibility of the owner or occupant of the premises on which such equipment is located.

Maintenance on vapor-recovery system or vapor-processing equipment shall be performed by the manufacturer of the affected equipment, or an equally qualified person. Written records of maintenance, tests, inspections and the results and recommendations shall be maintained on the premises where the equipment is located, and shall be made available to the Fire Code Official on request.

Incidents involving leaks, fires, explosions, overheating or requiring shutting down equipment, other than for routine maintenance or tests, shall be immediately reported to the Fire Department.

18.48.660 – CFC Chapter 35—Welding and other hot work.

Chapter 35 of the California Fire Code is amended by the addition of Sections 3510 and 3511 to read:

SECTION 3510 – WELDING AND CUTTING ABOARD VESSELS

3510.1 General. No person shall perform any welding or cutting operations aboard any vessel moored or anchored in the waterfront facilities under the jurisdiction of the Long Beach Harbor Department without first complying with the regulations of the Port of Long Beach Tariff and notifying the Fire Department.

3510.2 Conditions. No person shall perform any welding or cutting operations aboard any vessel moored, anchored or in drydock or on any waterfront facility within the corporate limits of the City, which are not included and regulated in Section 3510.1 above, at any yacht moorage, shipyard, boat landing or marina without first notifying and receiving permission from the proper authority as hereinafter defined:

1. Proper authority for a yacht moorage, shipyard, boat landing or marina shall mean the manager or owner. Prior to giving permission to do welding or cutting, a permit shall be obtained from the Fire Department.
2. Proper authority for any area not covered in (1) shall be the Fire Code Official.

3510.3 Special hazards. Welding or cutting shall be prohibited aboard any vessel in congested moorage, except as approved by the Fire Code Official or in an approved shipyard site where adequate fire protection, as approved by the Fire Code Official, is provided. Vessels shall be located in such a manner as to facilitate their quick removal in case of fire or other emergency. If an unusual hazard exists which endangers life or property, the Fire Code Official may require sufficient and competent personnel to be immediately available to move the vessel in the event of an emergency.

3510.4 Access. Brows, gangways, ladders or other facilities shall be provided for prompt and easy access to a vessel upon which welding or cutting is being conducted. A Jacobs ladder or other suitable equipment may be required to be rigged on the offshore side in such a manner that it can be immediately lowered for a boarding party in the event of an emergency.

3510.5 Prohibitions. Welding and cutting prohibited:

1. Within two hundred feet of any vessel or any transfer apparatus on any waterfront facility while transferring any liquefied petroleum gas, liquefied natural gas, or flammable liquid between such vessel and/or waterfront facility.
2. Within one hundred feet of any vessel or any transfer apparatus on any waterfront facility while transferring any combustible liquid between such vessel and/or waterfront facility.

3510.6 Dangerous conditions. At any time the General Manager of the Port, the Director of the Marine Division, or their authorized assistants, the Master of the vessel, the Fire Code Official, or any other responsible person is aware of a dangerous condition existing during welding or cutting operations, he/she shall immediately cause such operations to be discontinued. Operations shall not be resumed until the danger is abated, and the Fire Department is satisfied that appropriate safety levels are being provided.

3510.7 Cylinder locations. Compressed gas and liquefied petroleum gas cylinders when being used aboard a vessel shall not be placed below decks or under overhanging decks except by permission of the Fire Code Official.

3510.8 Acetylene generators. The use of acetylene generators on vessels or waterfront facilities is prohibited.

3510.9 National standards. All welding and cutting operations covered by this section shall also comply with the requirements of other applicable sections of these regulations and with N.F.P.A. No. 303, "Fire Protection Standard for Marinas and Boatyards."

SECTION 3511 – TESTS AND RECORDS REQUIRED

3511.1 General. Wherever tests are required to determine the safety of welding and cutting operations, records shall be maintained to the satisfaction of the Fire Code Official. Additional tests and inspections shall be required to insure that safe conditions are maintained and to determine that welding or cutting operations may be conducted with safety under the following conditions:

1. If the work has been delayed for a prolonged period of time.
2. When transfer of ballast or manipulation of valves or closure equipment tends to alter conditions in pipelines, tanks or compartments subject to gas accumulation.
3. If there is removal or disturbance of hatches or separations from adjoining compartments aboard vessels.
4. If vessels or containers are moved from one area to another.

3511.2 Hazardous conditions. If at any time conditions become hazardous, the person making the test or inspection shall immediately notify the responsible person of the hazard. The responsible person shall immediately cause all operations to stop and remain stopped until the hazard is abated, and the Fire Department is satisfied that appropriate safety levels are being provided.

18.48.670 – CFC Chapter 36, Section 3604—Fire protection equipment.

Section 3604 of Chapter 36 of the California Fire Code is amended by the addition of Section 3604.7 to read:

3604.7 Cabinets. Cabinets for the protection of fire protection equipment shall be of non-corrosive materials.

18.48.680 – CFC Chapter 48, Section 4807.1—Fire safety officers.

Section 4807.1 of Chapter 48 of the California Fire Code is amended to read:

4807.1 Where permits are required by the fire code, a requirement for standby fire safety officers shall be determined by the fire code official on a case-by-case basis.

18.48.690 – CFC Chapter 56, Section 5601—General.

Section 5601 of Chapter 56 of the California Fire Code is amended by the addition of Sections 5601.2 and 5601.3 to read:

5601.2 Financial responsibility. Before a permit required by Chapter 1, Section 105.6.14 or 105.6.36 is issued, the permittee shall file with the Fire Code Official a certificate of insurance issued by an insurance company authorized to transact business in the State of California. Such certificate shall certify that the operations under the permit are covered by the policy. The insurance coverage shall not be less than One Million Dollars for injury or death of one person, One Million Dollars for injury or death to more than one person and One Million Dollars for damage to property in any one occurrence. Should the Fire Code Official decide that the activities of the permittee should be supervised by employees of the Fire Department, then the permittee shall furnish to the Fire Code Official the original or certified copy of the policy of insurance in the amounts above provided. The City of Long Beach, its officers, agents, employees and volunteers shall be named parties insured under said policy insofar as the activities of such officers and employees pertain to operations of permittee under the permit. The policy of insurance shall be approved by Risk Management as to sufficiency and the City Attorney as to form. Upon approval, the policy of insurance will be returned if permittee files a certificate of insurance issued by the insurance carrier. No insurance will be required if the permittee is a public agency.

5601.3 Qualifications. The handling and firing of explosives shall be performed only by authorized pyrotechnicians licensed by the State of California, or by employees who are at least 18 years of age under the direct personal supervision of the authorized blaster.

18.48.700 – CFC Chapter 56, Section 5608—Fireworks Display.

Section 5608 of Chapter 56 of the California Fire Code is amended by the addition of Sections 5608.2, 5608.3 and 5608.4 to read:

5608.2 Prohibition. Except as hereinafter provided, it shall be unlawful for any person to possess, store, offer for sale, expose for sale, sell at retail, or use or explode any fireworks, provided that the Fire Code Official shall have power to adopt reasonable rules and regulations for the granting of permits for supervised public displays of fireworks by a jurisdiction, fair associations, amusement parks, other organizations or for the use of fireworks by artisans in pursuit of their trade. Every such use or display shall be handled by a competent operator approved by the Fire Code Official and shall

be of such character and so located, discharged or fired so as, in the opinion of the Fire Code Official after proper investigation, not to be hazardous to property or to endanger any person.

5608.3 Financial responsibility. Before a permit required by Chapter 1, Section 105.6.14 is issued, the permittee shall file with the Fire Code Official a certificate of insurance issued by an insurance company authorized to transact business in the State of California. Such certificate shall certify that the operations under the permit are covered by the policy. The insurance coverage shall not be less than One Million Dollars for injury or death of one person, One Million Dollars for injury or death to more than one person and One Million Dollars for damage to property in any one occurrence. Should the Fire Code Official decide that the activities of the permittee should be supervised by employees of the Fire Department, then the permittee shall furnish to the Fire Code Official the original or certified copy of the policy of insurance in the amounts above provided. The City of Long Beach, its officers, agents, employees and volunteers shall be named parties insured under said policy insofar as the activities of such officers and employees pertain to operations of permittee under the permit. The policy of insurance shall be approved by Risk Management as to sufficiency and the City Attorney as to form. Upon approval, the policy of insurance will be returned if permittee files a certificate of insurance issued by the insurance carrier. No insurance will be required if the permittee is a public agency.

5608.4 Qualifications. The handling and firing of explosives shall be performed only by authorized pyrotechnicians licensed by the State of California, or by employees who are at least 18 years of age under the direct personal supervision of the authorized blaster.

18.48.710 – CFC Chapter 57, Section 5704.2.11.3—Depth and cover.

Section 5704.2.11.3 of Chapter 57 of the California Fire Code is amended to read:

5704.2.11.3 Depth and cover. Excavation for underground storage tanks shall be made with due care to avoid undermining of foundations of existing structures. Underground tanks shall be set on firm foundations and surrounded with at least 6 inches of noncorrosive inert material such as clean sand or gravel well tamped in place or in accordance with the manufacturer's installation instructions. Tanks shall be covered with a minimum of 2 feet of earth or shall be covered by not less than 1 foot of earth, on top of which shall be placed a slab of reinforced concrete not less than 4 inches thick.

When underground tanks are, or are likely to be, subject to traffic, they shall be protected against damage from vehicles passing over them by at least 3 feet of earth cover, or 18 inches of well tamped earth plus 6 inches of reinforced concrete, or 8 inches of asphaltic concrete. When asphaltic or reinforced concrete paving is used as part of the protection, it shall extend at least 1 foot horizontally beyond the outline of the tank in all directions.

For tanks built in accordance with Sections 3404.2.7 the burial depth and the height of the vent line shall be such that the static head imposed at the bottom of the tank will not exceed 10 psig if the fill or vent pipe is filled with liquid.

If the depth of cover exceeds 7 feet or the manufacturer's specifications, reinforcements shall be provided in accordance with the tank manufacturer's recommendations.

Nonmetallic underground tanks shall be installed in accordance with the manufacturer's instructions. The minimum depth of cover shall be as specified above.

18.48.720 – CFC Chapter 57, Section 5705.3.5.2—Occupancy quantity limits.

Section 5705.3.5.2 of Chapter 57 of the California Fire Code is amended by the addition of the following paragraph to Subsection 7, Group R Occupancies, to read:

In dwellings and apartment houses containing not more than three dwelling units and accompanying attached or detached garages, storage other than fuel oil is prohibited, except that which is required

for maintenance or equipment operation which shall not exceed five gallons in non sprinklered building or ten gallons in sprinklered occupancies. Containers shall be listed or approved for the specific product to be stored, and shall have an exterior label identifying the product in the container.

18.48.730 – CFC Chapter 61, Section 6101—General.

Section 6101 of Chapter 61 of the California Fire Code is amended by the addition of Section 6101.4 to read:

6101.4 Inside storage or use. No liquefied petroleum gases of any type or mixture shall be permitted in any occupancy either for sale, use or storage without the approval of the Fire Code Official.

18.48.740 – CFC Chapter 61, Section 6103.2.2—Industrial vehicles and floor maintenance machines.

Section .2.2 of Chapter 61 of the California Fire Code is amended by the addition of Section 6103.2.2.1 to read:

6103.2.2.1 Portable cylinders. The use of portable cylinders of liquefied petroleum gas as motorized equipment fuel in occupancies is limited as follows: Liquefied petroleum gas fuel tanks on motorized equipment are limited to two per vehicle with a combined capacity not to exceed fifty pounds. Refilling or exchanging of tanks shall not be permitted within the occupancy and shall be permitted only in approved locations as determined by the Fire Code Official.

18.48.750 – CFC Chapter 61, Section 6104.3—Container location.

Section 3804.3 of Chapter 38 of the California Fire Code is amended by the addition of Section 6104.3.3 to read:

6104.3.3 Tank orientation. Unless special protection is provided and approved by the Fire Code Official, containers of liquid petroleum gas shall be oriented so that their longitudinal axes do not point toward other liquid petroleum containers, vital process equipment, control rooms, loading stations, flammable liquid storage tanks or required fire access roads.

18.48.760 – CFC Chapter 61, Section 6101.3—Construction documents.

Section 6101.3 of Chapter 61 of the California Fire Code is amended to read:

6101.3 Construction documents. The installer shall submit construction documents for any single or multi LP-gas container or system installation.

18.48.770 – CFC Appendix Chapter B, Section B105.2—Buildings other than one- and two-family dwellings.

Exception #1 for Section B105.2 of Appendix Chapter B of the California Fire Code is amended to read:

Exception #1: A reduction in required fire-flow of up to 50 percent, as approved, is allowed when the building is provided with an approved automatic sprinkler system installed in accordance with Section 903.3.1.1 or 903.3.1.2. The resulting fire flow shall not be less than 1,500 gallons per minute for the prescribed duration as specified in Table B105.1.

CHAPTER 18.60 MOVING BUILDINGS

- 18.60.010 – Definitions.
- 18.60.020 – Permit—Required.
- 18.60.030 – Permit—Qualification for issuance.
- 18.60.040 – Permit—Terms and conditions of issuance.
- 18.60.050 – Permits—Application—Examination of structure.
- 18.60.060 – Payment of permit fees.
- 18.60.070 – Moving notice—Posting—Contents.
- 18.60.080 – Notice of decision to grant or deny permit.
- 18.60.090 – Written protests against moving—Hearing.
- 18.60.100 – Public hearing on protests—Notice.
- 18.60.110 – Hearing and determination by Council.
- 18.60.120 – Issuance of permit.
- 18.60.130 – Bond—Posting required.
- 18.60.140 – Bond—Conditions.
- 18.60.150 – Bond—Notice of default to principal and surety.
- 18.60.160 – Bond—Default—Option of surety.
- 18.60.170 – Bond—Term.
- 18.60.180 – Bond—Rights of access to premises.
- 18.60.190 – Expiration of permit—Extension.
- 18.60.200 – Fee schedule.
- 18.60.210 – Route—Approval of Police, Park, and Public Works Departments.
- 18.60.220 – Applicability of chapter.

CHAPTER 18.60 MOVING BUILDINGS

18.60.010 – Definitions.

The following terms, as used in this chapter, shall have the signification attached to them in this section unless otherwise clearly apparent from the context:

- A. "Building or structure" means and includes a structure or edifice which is more than ten (10) feet in width or more than twelve (12) feet in length, or which contains more than one hundred twenty (120) square feet of floor area.
- B. "Building and structure mover" is a person who undertakes or offers to undertake, or purports to have the capacity, to move a building or structure, or to do building or structure moving work.
- C. "Building or structure moving work" means and includes the moving of a "building or structure", as defined in Subsection 18.60.010.A, in any horizontal direction, and includes the shoring, raising, or lowering of a building or structure preparatory to the actual moving of the building or structure.

18.60.020 – Permit—Required.

No person shall move a building or structure over, upon or along any street, or from a location on one lot to a location on another lot, or perform any part of such moving work unless the building or structure has first been examined and posted in the manner required in this chapter, and a permit in writing to do so for each and every separate moving operation has been applied for and obtained from the Building Official. However, any person fully complying with the provisions of this chapter may obtain a permit to move a building or structure to a location outside the City, or to a building or structure mover's yard for storage, or for the severance of a building or structure from real property pursuant to local, State or federal government requirements. In each such instance, no examination, posting or completion bond shall be required, such requirements being waived. However, all such requirements shall be fully complied with prior to the removal of each such building or structure from such storage yard or severance location to a location within the City limits. Nothing in this chapter shall be deemed applicable to the moving of a building or structure from one location on a lot to another location on the same lot. See Chapters 18.04 and 18.07.

18.60.030 – Permit—Qualification for issuance.

No moving permit shall be issued to any person unless the applicant therefore holds a valid unrevoked state house and building moving, wrecking contractor's license, and has filed with the City a bond or a liability or indemnity policy of insurance as required by the City for a building or structure mover's license. The provisions of this section shall not, however, be deemed to prohibit any general contractor or owner of any building or structure from obtaining a permit to move such building or structure from one location on a lot or parcel to a different location on the same lot or parcel.

18.60.040 – Permit—Terms and conditions of issuance.

No permit shall be issued to relocate any building or structure which is so constructed or in such condition as to be dangerous; or which is infested with pests or unsanitary; or which is unfit for human habitation, if it is to be so utilized; or which is so dilapidated, defective, unsightly or in such a condition of deterioration or disrepair that its relocation at the proposed site would cause appreciable harm to or be materially detrimental to the property or improvements in the district within a radius of five hundred (500) feet from the proposed site; or if it is determined that it is detrimental to the future development of the area; or if the proposed use is prohibited by Title 21 Zoning Regulations of this City; or if the building or structure is of a type prohibited at the proposed location by any other law or ordinance; provided, however, that if the condition of the building or structure, in the judgment of the Building Official, admits of practicable and effective repair, the permit may be issued upon condition as provided in this chapter.

18.60.050 – Permits—Application—Examination of structure.

- A. Before a moving permit is issued, the person or persons proposing to do such work shall pay to the City the fees as required in Section 18.60.200 and shall complete an application form furnished by the Building Official and shall set forth such information thereon as the Building Official may reasonably require in order to carry out the purposes of this chapter. Said official shall then cause to be made an examination of the building or structure proposed to be moved, and the location to which it is proposed to move the same, if such location is within the City and if such examination is required by this chapter. The Building Official shall post the building in the manner specified in Section 18.60.070 and the date of this posting shall commence the seven-day period for the filing of a protest by the property owners within a radius of three hundred (300) feet of the relocation site as specified in this chapter.
- B. A separate application upon a form furnished by the Building Official must be filed and a separate permit obtained for the moving of each separate building or structure, or portion of a building or structure, except that neither posting, examination fee, nor separate permit will be required when a garage is moved with and under the same permit obtained for the moving of a single-family dwelling, provided the moving of the dwelling and garage is completed in one moving operation and such garage and dwelling are to be located on one parcel.
- C. The Building Official shall, in granting any moving permit, impose thereon such terms and conditions as it may deem reasonable and proper in accordance with the provisions of this chapter.
- D. The terms and conditions upon which each permit is granted shall be written upon the permit, or appended, in writing, thereto.
- E. In addition to the posting of the notice, the Building Official shall mail a copy of the notice to each person indicated upon the records of the County Assessor as being the owner of any property within a radius of three hundred (300) feet of the location to which the building or structure is to be moved.

18.60.060 – Payment of permit fees.

- A. Every applicant for a moving permit shall, at the time of application therefore, pay to the City the required permit fees as set forth in Section 18.60.200, and shall complete a permit application upon a form furnished by the Building Official, and shall set forth upon the form the size of building or structure, by street and number, and by legal description of both locations, together with the specific route to be traversed by the building or structure in the process of being moved from one location to another. Upon the same form the applicant shall make an affidavit that, in placing the building or structure in its new location, it shall not be in violation of any of the provisions of this chapter, any zoning regulations in Title 21 of the Long Beach Municipal Code, or other law or ordinance applicable to such building or structure.
- B. No moving permit shall authorize the moving of more than one building or structure or more than one section or portion of any building or structure, or when such building or structure to be moved is cut into two or more sections or portions; except that one moving permit only shall be required for the moving of a single-family dwelling and garage; provided, however, that neither the garage nor dwelling is cut into sections for the purpose of moving; and further provided, that the moving of the dwelling and garage is completed in one moving operation.

18.60.070 – Moving notice—Posting—Contents.

- A. The moving notices shall be posted by the Building Official and shall be placed conspicuously upon the front and upon the rear of the location to which it is proposed to move a building or structure, and upon the front of the building or structure proposed to be moved. Such notices

shall be not less in size than eight (8) inches by ten (10) inches and shall bear, in letters not less than one and one-half (1.5) inches in height, the words "MOVING NOTICE". In addition, such notice shall contain the following information:

1. Name and owner of the building or structure after its relocation;
2. A brief description of the building or structure;
3. Address of the building or structure at its present location;
4. The street and number to which the building or structure is proposed to be moved;
5. The date upon which the building or structure was posted with the notices;
6. The name of the building and structure mover or person who proposes to do the moving work;
7. The name of the Building Official who inspects the building or structure and relocation site.

B. Upon the notice there shall also appear the following:

“Any property owner within a radius of three hundred (300) feet of the relocation site may file a written protest with the Building Official within seven (7) days of the date of the signing and dating of this notice by the Building Official. In the event of such protest, the Board of Examiners, Appeals and Condemnation will set a date at which time they will hold a hearing and either approve the moving of the building or structure, or sustain the protest.”

18.60.080 – Notice of decision to grant or deny permit.

If, after making the examination, the Building Official determines, in accordance with the standards set forth in this chapter, that the application for permit should be denied or should be granted under certain specified conditions, he or she shall notify the applicant of his or her decision by letter, postage prepaid, addressed as shown on the application for permit. If such application is to be granted under certain conditions, such conditions shall specifically be set forth in such notice. The decision of the Building Official shall be final and conclusive, and such notice shall so state, unless within seven (7) days after the mailing of such notice, the applicant has filed with the Building Official a written appeal from that official's decision, specifying the grounds of such appeal. Any such appeal shall be heard by the Board of Examiners, Appeals and Condemnation as provided hereinafter.

18.60.090 – Written protests against moving—Hearing.

Any property owner within a radius of three hundred (300) feet of the relocation site may file a written protest with the Building Official within seven (7) days of the date of the posting of the moving notice. In the event of such protest, the Board of Examiners, Appeals and Condemnation will set a date at which time they will hold a hearing and either approve the moving of the building or structure, or sustain the protest.

18.60.100 – Public hearing on protests—Notice.

If any written protests against the proposed building or structure moving work are filed with the Building Official, and such protests are postmarked on or before the expiration of the seven (7) day posting period, or if the applicant has theretofore filed an appeal from the decision of the Building Official as hereinabove provided, the Building Official shall, within three (3) days following the expiration of the above seven (7) day posting period, present the protest or appeal by the applicant to the Board of Examiners, Appeals and Condemnation at its next regular meeting. The Board of Examiners, Appeals and Condemnation shall set a time for public hearing on such protest, or on such appeal, which time of hearing shall be not less than ten (10) nor more than thirty (30) days from the

time the Board of Examiners, Appeals and Condemnation received the protest or appeal. When the time for public hearing has been so set, the Building Official shall mail a notice thereof, postage prepaid, to each person having filed a written protest, at the address, if any, specified thereon. The Building Official shall, in all cases, also send a notice of such hearing by registered mail, postage prepaid, to the applicant, whether or not he has appealed from the decision of the Building Official. Such notice shall also be sent to the applicant's representative if one has been specified. Such notices of public hearing shall be mailed at least five (5) days prior to the date of such hearing.

18.60.110 – Hearing and determination by Board of Examiners, Appeals and Condemnation.

At the time set for public hearing, the Board of Examiners, Appeals and Condemnation shall hear and pass upon the protests filed and the applicant's appeal, if any, from the decision of the Building Official. Based upon the evidence adduced at such hearing, or as obtained from an examination made by the Board of Examiners, Appeals and Condemnation of the building or structure, proposed route to be traversed and proposed new location, the Board of Examiners, Appeals and Condemnation may direct the Building Official to deny the application or may direct that such permit be granted by the Building Official on the same terms and conditions previously specified by that official or in accordance with such terms and conditions as the Board of Examiners, Appeals and Condemnation may deem proper in the premises; provided, however, that the Board of Examiners, Appeals and Condemnation shall, in arriving at its determination, be governed by the same standards, limitations and norms as are set forth in Section 18.60.040. The Board of Examiners, Appeals and Condemnation shall not, in any event, order the Building Official to grant such permit under any conditions if the same will result in the moving or relocation of any structure which would be a violation of any City, County or State law, or would clearly inconvenience any considerable number of persons, or would violate or disturb the public welfare, safety or peace.

18.60.120 – Issuance of permit.

After the moving notices have been in place seven (7) days, and if the Building Official has written a letter of intent to grant, and if no written protest has been filed with the Building Official against the proposed moving, and if the applicant has not appealed from the decision of the Building Official, a moving permit shall be granted in accordance with the conditions specified by the Building Official, upon the filing of the required bond.

18.60.130 – Bond—Posting required.

Notwithstanding anything to the contrary herein, no moving permit shall be issued unless the applicant first posts with the Building Official a bond or insurance as prescribed in regulations issued by the City Manager pursuant to Section 2.84.040.

18.60.140 – Bond—Conditions.

Every bond posted pursuant to this section shall be conditioned as follows:

- A. Each and all of the terms and conditions of the moving permit shall be complied with to the satisfaction of the Building Official;
- B. All of the work required to be done pursuant to the terms and conditions of the moving permit shall be fully performed and completed within the time limit specified in Section 18.60.190. The time limit may be extended for good and sufficient cause by the Building Official pursuant to Section 18.03.050. No such extension of time shall be valid unless written, and no such extension shall release any surety upon any bond.

18.60.150 – Bond—Notice of default to principal and surety.

- A. Whenever the Building Official finds that a default has occurred in the performance of any term or condition of any permit, written notice thereof shall be given to the principal and to the surety on

the bond. Such notice shall state the work to be done, the estimated cost thereof, and the period of time deemed by the Building Official to be reasonably necessary for the completion of such work. After receipt of such notice, the surety must, within the time therein specified, either cause the required work to be performed or, failing therein, must pay over to the Building Official the estimated cost of doing the work, as set forth in the notice, plus an additional sum equal to twenty-five percent (25%) of the estimated cost. Upon the receipt of such money, the City shall proceed, by such mode as it deems convenient, to cause the required work to be performed and completed, but no liability shall be incurred therein other than for the expenditure of the sum of money in hand therefore.

- B. If a cash bond has been posted, notice of default, as provided above, shall be given to the principal, and if compliance is not had within the time specified, the City shall proceed without delay and without further notice of proceedings whatever to use the cash deposit, or any portion of such deposit, to cause the required work to be done, by contract or otherwise, in the discretion of the City. The balance, if any, of such cash deposit shall, upon the completion of the work, be returned to the depositor, or to his or her successors or assigns, after deducting the cost of the work, plus twenty-five percent (25%) thereof.

18.60.160 – Bond—Default—Option of surety.

When any default has occurred on the part of the principal under the provisions of Section 18.60.150, the surety shall have the option, in lieu of completing the work required, to demolish the building or structure, and to clear, clean and restore the site. If the surety defaults, the City shall have the same option.

18.60.170 – Bond—Term.

The term of each bond furnished pursuant to Sections 18.60.130 through 18.60.180 shall commence upon the date of the posting thereof and shall terminate upon the completion, to the satisfaction of the Building Official, of the performance of all of the terms and conditions of the moving permit. Such completion shall be evidenced by a statement thereof, signed by the Building Official, a copy of which will be sent to any surety or principal upon request. When a cash bond has been posted, the cash shall be returned to the depositor, or to his or her successors or assigns, upon the termination of the bond, except any portion thereof that may have been used or deducted as provided elsewhere in Sections 18.60.130 through 18.60.180.

18.60.180 – Bond—Rights of access to premises.

The Building Official, the surety, and the duly authorized representative of either, shall have access to the premises described in the moving permit for the purpose of inspecting the progress of the work. In the event of any default in the performance of any term or condition of the moving permit with reference to the relocation of a structure, the surety, or any person employed or engaged on its behalf, or the Building Official, or any person employed or engaged on his or her behalf, shall have the right to go upon the premises to complete the required work or to remove or demolish the building or structure. It is unlawful for the owner, or his or her representatives, successors or assigns, or any other person, to interfere with or obstruct the ingress to or egress from any such premises of any authorized representative or agent of any surety or of the City engaged in the work of completing, demolishing or removing any building or structure for which a moving permit has been issued, after a default has occurred in the performance of the terms or conditions thereof.

18.60.190 – Expiration of permit—Extension.

Every application for a moving permit issued by the Building Official under the provisions of this chapter shall expire and become null and void at the expiration of a period of ninety (90) days from the date of such application, and every moving permit issued by the Building Official under the provisions of this chapter shall expire and become null and void if the moving work authorized by such permit is not commenced and completed within sixty (60) days from the date of issuance;

provided, however, that the Building Official may extend these periods when the moving of any building or structure is impossible or delayed by reason of inclemency of weather, strikes or other causes not within the control of the mover. If for any reason a moving permit or application therefore is rendered null and void under the provisions of this chapter, and the moving work is desired to be done thereafter, a new application shall be made and a permit obtained from the Building Official, and new fees shall be paid.

18.60.200 – Fee schedule.

In addition to any other fee or fees required, a moving permit fee and, when required, an examination and posting fee, shall be paid to the Building Official as set forth in the schedule of fees and charges established by City Council resolution. Examinations and posting fees shall be paid prior to any examination or investigation by the Building Official.

18.60.210 – Route—Approval of Police, Park, and Public Works Departments.

- A. Wherever any building or structure is to be moved over or upon a public street or highway within the City, the application therefore shall be submitted to the Police Chief, who shall endorse the approval of the Police Department thereon as to the routes to be traveled and the hours during which moving operations are to be conducted under the proposed permit. If the routes or hours do not meet with the approval of the Police Department, it shall be the duty of the applicant to alter his or her application to include such routes and hours as will meet the approval of the Police Department.
- B. Such application shall also be submitted to the Department of Parks, Recreation and Marine and the designated route to be traveled subject to its approval. Applications may also be submitted to the Department of Public Works when in the discretion of the Building Official wheel loads for any given route may be deemed excessive. In those instances, the Department of Public Works may require the applicant to submit wheel size, load, spacing and any other pertinent information. The Department of Public Works may require modification of the loading or shoring of specific structures or such other precautions as it deems necessary to adequately protect the street and those buildings or structures over which the building or structure will pass.

18.60.220 – Applicability of chapter.

The provisions of this chapter shall not apply to the relocation of buildings or structures to be used by a governmental agency for a governmental purpose.

CHAPTER 18.61 NPDES AND SUSMP REGULATIONS

18.61.010 – Purpose.

18.61.020 – Definition.

18.61.030 – Exception.

18.61.040 – Applicability.

18.61.050 – NPDES and SUSMP Regulations Manual.

CHAPTER 18.61 NPDES AND SUSMP REGULATIONS

18.61.010 – Purpose.

The purpose of this chapter is to provide regulations and give legal effect to certain requirements of the National Pollutant Discharge Elimination System (NPDES) permit issued to the City of Long Beach, and the subsequent requirements of the Standard Urban Storm Water Mitigation Plan (SUSMP), mandated by the California Regional Water Quality Control Board, Los Angeles region (RWQCB). The intent of these regulations is to effectively prohibit non-storm water discharges into the storm drain systems or receiving waters and to require source control BMP to prevent or reduce the discharge of pollutants into the storm water to the maximum extent practicable.

18.61.020 – Definition.

Unless otherwise expressly stated, the following words and terms shall, for the purpose of this chapter, have the meanings as defined in the NPDES and SUSMP Regulations Manual. Where the terms are not defined in the NPDES and SUSMP Regulations Manual, such terms shall have ordinarily accepted meaning such as the context implies. Webster's Third New International Dictionary of the English Language, Unabridged shall be considered as providing ordinarily accepted meanings.

18.61.030 – Exception.

Non-storm water discharges into the storm drain systems or to receiving waters are prohibited except where such discharges are expressly permitted in the NPDES and SUSMP Regulations Manual.

18.61.040 – Applicability.

New development projects and redevelopment projects in the City subject to the design and implementation of post-construction controls to mitigate storm water pollution, prior to completion of the projects, shall apply if required in the NPDES and SUSMP Regulations Manual.

- A. 18.61.050 – NPDES and SUSMP Regulations Manual. The Building Official shall prepare, maintain, and update, as deemed necessary and appropriate, the NPDES and SUSMP Regulations Manual and shall include technical information and implementation parameters, alternative compliance for technical infeasibility, as well as other rules, requirements and procedures as the City deems necessary, for implementing the provisions of this chapter.
- B. The Building Official shall develop, as deemed necessary and appropriate, in cooperation with other City departments and stakeholders, informational bulletins, training manuals and educational materials to assist in the implementation of this chapter.

CHAPTER 18.62 REPORT ON AVAILABLE OFF-STREET PARKING SPACES UPON RESALE

- 18.62.010 – Intent and purpose.
- 18.62.020 – Definitions.
- 18.62.030 – Report or exemption certificate required.
- 18.62.040 – Application.
- 18.62.050 – Inspection.
- 18.62.060 – Citation.
- 18.62.070 – Delivery of report.
- 18.62.080 – Exemption certificate.
- 18.62.090 – Exclusions.
- 18.62.100 – Penalties.

CHAPTER 18.62

REPORT ON AVAILABLE OFF-STREET PARKING SPACES UPON RESALE

18.62.010 – Intent and purpose.

It is the intent of the City Council to assure that all parties to a transaction involving a sale of a residential building within the City of Long Beach within areas designated by City Council as parking-impacted areas are furnished a report on the availability of legally required off-street parking spaces. It is the purpose of this chapter that the requirement of such a report will reduce violations on existing parcels of residential property and will prevent violations in the future.

18.62.020 – Definitions.

- A. "Owner" shall mean any person, co-partnership, association, corporation or fiduciary having legal or equitable title or any interest in any real property.
- B. "Residential building" shall mean any improved real property designed or permitted to be used for dwelling purposes, situated in the City, and shall include the building or structures located on said improved real property.
- C. "Agreement of sale" shall mean any agreement or written instrument which provides that title to any property shall thereafter be transferred from one owner to another owner.
- D. "Common parking" shall mean any parking facility serving more than one (1) dwelling unit with a common entrance and a common exit.

18.62.030 – Report or exemption certificate required.

Upon entering into an agreement of sale or exchange of any residential building in a parking-impacted area, as such an area or areas may be designated from time to time for the purposes of this Chapter 18.62 by resolution of the City Council, unless excluded by Section 18.62.090, the owner or his authorized representative shall obtain from the City a report setting forth the legally required off-street parking for such property and a statement as to its availability or lack of availability, or an exemption certificate. The report shall specifically identify any off-street parking spaces which should be used for vehicle parking but are not available for such use because of illegal conversion to another use, or any physical condition which prohibits the use of such spaces for normal parking of an automobile. Said report or exemption certification shall be valid for a period not to exceed six (6) months from date of issue.

18.62.040 – Application.

Upon application of the owner or his authorized agent and accompanied by a fee, or a fully executed letter/agreement authorizing payment out of escrow, in or of an amount as set forth in the schedule of fees and charges established by City Council resolution, the Director shall review pertinent City records, cause an on-site inspection of the property as provided by Section 18.62.050, and deliver to the applicant a report on the availability of legally required off-street parking.

18.62.050 – Inspection.

In addition to the information supplied in Section 18.62.040, the Director shall cause a physical inspection of the subject property or, should entry be refused, the Director shall indicate on said report that entry was refused.

18.62.060 – Citation.

The Director shall cite any unlawful condition relating to the use and maintenance of off-street parking spaces. Such condition shall be brought into compliance within ninety (90) days of said citation, or

within sixty (60) days of close of escrow, whichever comes first. If such compliance is not obtained, formal enforcement proceedings shall be prosecuted as provided by law.

18.62.070 – Delivery of report.

The report on the availability of legally required off-street parking prepared pursuant to Section 18.62.030 shall be delivered by the owner or the authorized designated representative of the owner to the buyer or transferee of the residential building proper to the consummation of the sale or exchange. The buyer or transferee shall execute a receipt therefore as furnished by the City and said receipt shall be delivered to the Department as evidence of compliance with the provisions of Section 18.62.030.

18.62.080 – Exemption certificate.

The following exceptions shall require an exemption certificate in lieu of the parking availability report:

- A. Condominiums, townhomes, apartment buildings and similar buildings whose parking is supplied completely by way of a common parking facility;
- B. The first sale of a residential building which has never been occupied;
- C. A residential building whereby a review of the records indicates that no parking was ever provided at the site.

18.62.090 – Exclusions.

The provisions of this chapter shall not apply to:

- A. Transfers which are required to be preceded by the furnishing to a prospective transferee of a copy of a public report pursuant to Section 11018.1 of the California Business and Professions Code;
- B. Transfers pursuant to court order, including, but not limited to, transfers ordered by a probate court in administration of an estate, transfers pursuant to a writ of execution, transfers by a trustee in bankruptcy, transfers by eminent domain, or transfers resulting from a decree for specific performance;
- C. Transfers to a mortgagee by a mortgagor in default, transfers to a beneficiary of a deed of trust by a trustor in default, transfers by any foreclosure sale after default, transfers by any foreclosure sale under default in an obligation secured by a mortgage, or transfers by sale under a power of sale after a default in an obligation secured by a deed of trust or secured by any other instrument containing a power of sale;
- D. Transfer by a fiduciary in the course of the administration of a guardianship, conservatorship, or trust;
- E. Transfers from one co-owner to one or more co-owners;
- F. Transfers made to a spouse, or to a person or persons in the lineal, line or consanguinity of one or more of the transferors;
- G. Transfers between spouses resulting from a decree of dissolution of a marriage or a decree of legal separation or from a property settlement agreement incidental to such decrees;
- H. Transfers by the State Controller in the course of administering the Unclaimed Property Law (Chapter 7 [commencing with Section 1500] of Title 10 of Part 3 of the California Code of Civil Procedure);

- I. Transfers to a governmental entity under eminent domain or threat of eminent domain.

18.62.100 – Penalties.

- A. Anyone in violation of the provisions of this chapter shall be guilty of a misdemeanor and upon conviction thereof shall be punishable as provided by the provisions of Section 1.32.010 of the Long Beach Municipal Code.
- B. No sale or exchange of residential property shall be invalidated solely because of the failure of any person to comply with any provisions of this chapter unless such failure is an act or omission which would be a valid ground for rescission of such sale or exchange in the absence of this chapter.

CHAPTER 18.63 ALTERNATIVE BUILDING STANDARDS FOR ADAPTIVE REUSE PROJECTS

18.63.010 – Purpose.

18.63.020 – Applicability.

18.63.030 – Alternative Building Standards Manual.

CHAPTER 18.63

ALTERNATIVE BUILDING STANDARDS FOR ADAPTIVE REUSE PROJECTS

18.63.010 – Purpose.

The Adaptive Reuse Ordinance in Title 21 Zoning Regulations expanded the scope of eligible and underutilized buildings or structures that have great potential to be converted into new uses or occupancy that can benefit from relief of parking standards, setbacks and zoning height limitations. However, key to the success of the Adaptive Reuse Ordinance relies on the ability of the Building Official and Fire Code Official to effectively use their authority to grant code modification or alternative materials, design and methods of construction and equipment to address practical difficulties involved in complying with the strict provisions of the code or consider alternative design or methods not specifically prescribed in the code. Other statutory regulations such as the most recently adopted edition of the California Historic Building Code and Chapter 34 of the California Building Code, including Sections 17958.11 and 19957 of the California Health and Safety Code, provides the Building Official and Fire Code Official with the ability to consider other alternative building standards. Therefore, the purpose of this chapter is to amend, expand, establish and clarify alternative building standards for the conversion of existing buildings or structures to accommodate new uses or occupancy for other purposes than what it was originally designed for and still provide reasonable use and safety to the building occupants.

18.63.020 – Applicability.

Projects that meet the definition and applicable requirements of an adaptive reuse project pursuant to Title 21 Zoning Regulations may be permitted to use the alternative building standards of this chapter. The requirement of Section 18.63.030 may apply to the following projects:

1. Conversion of existing non-residential buildings, or portion thereof, to joint live/work units for artists and artisans, provided no more than thirty-three percent (33%) of any unit shall be used for residential purposes.
2. Conversion of existing non-residential buildings, or portion thereof, to other residential uses or occupancy.
3. Conversion of existing non-residential buildings, or portion thereof, to other non-residential uses or occupancy.
4. Conversion of existing residential buildings, or portion thereof, to non-residential uses or occupancy.

18.63.030 – Alternative Building Standards Manual.

- A. Although other chapters or sections of the Long Beach Municipal Code and the most recently adopted edition of the California Building Standards Code are applicable to new construction or a change of use or occupancy, the use of the Alternative Building Standards Manual may be permitted to provide alternative regulations for adaptive reuse projects that meet the applicability requirement of Section 18.63.020.
- B. The Building Official and Fire Code Official shall prepare, maintain, and update, as deemed necessary and appropriate, the Alternative Building Standards Manual and shall include technical information and implementation parameters, alternative compliance for technical infeasibility, as well as other rules, requirements and procedures as the City deems necessary, for implementing the provisions of this chapter.
- C. The Building Official and Fire Code Official shall develop, as deemed necessary and appropriate, in cooperation with other City departments and stakeholders, informational bulletins, training manuals and educational materials to assist in the implementation of this chapter.

CHAPTER 18.64 SANDBLASTING

- 18.64.010 – Permit—Required.
- 18.64.020 – Permit—State license required.
- 18.64.030 – Permit—Separate premises.
- 18.64.040 – Permit—Application.
- 18.64.050 – Permit—Inspection fee.
- 18.64.060 – Notice of sandblasting.
- 18.64.070 – Dry sandblasting.
- 18.64.080 – Permitted hours.
- 18.64.090 – Property protection.

**CHAPTER 18.64
SANDBLASTING**

18.64.010 – Permit—Required.

- A. No person, firm or corporation shall engage in sandblasting the outside of any building or structure in the City without first obtaining a permit to do so from the Building Official.
- B. The permit is required for the purpose of placing the City on notice regarding intended sandblasting operations, thus making possible the inspection of sandblasting operations in the City so that sandblasting regulations enacted for the protection of the health and property of members of the public may effectively be enforced.

18.64.020 – Permit—State license required.

No sandblasting permit shall be issued to any person not licensed or otherwise prohibited by State law from engaging in sandblasting operations.

18.64.030 – Permit—Separate premises.

A separate permit shall be required for each separate premises, court or group of structures to be sandblasted. More than one actual building or structure may be included on a single permit if all the buildings or structures are on one lot or one contiguous parcel of land.

18.64.040 – Permit—Application.

Each application for permit shall contain the following information:

- A. The name and address of the person or company applying for the permit;
- B. The location of the job;
- C. The building or structure or portion thereof to be sandblasted;
- D. Such other information as the Building Official shall reasonably require to aid in the proper inspection and enforcement of City sandblasting regulations.

18.64.050 – Permit—Inspection fee.

No sandblasting permit shall be issued prior to the payment of an inspection fee consistent with the fee schedule set forth in Chapter 18.06. No plan examination fee or other type of additional fee described in Chapter 18.06 shall be required.

18.64.060 – Notice of sandblasting.

Any person, firm or corporation conducting sandblasting in the City shall, not less than forty eight (48) hours prior to sandblasting, deliver to each residence or business establishment within one hundred (100) feet of all buildings or structures to be sandblasted a written notice stating in substance as follows:

NOTICE OF SANDBLASTING

On, _____
(Date or Dates)

20_____, sandblasting will be carried out on the exterior of the building at

(Address of building to be sandblasted)

(Name of company)

whose address is

The sandblasting will be conducted in accordance with Municipal Code Section 18.64.010 et seq., of the City of Long Beach.

(Name of owner or foreman)

(Address of owner or foreman)

18.64.070 – Dry sandblasting.

No person, firm or corporation shall engage in "dry" sandblasting in the City in the absence of written special permission from the Building Official, such special permission to be granted only if the particular circumstances of the job make wet sandblasting impractical.

18.64.080 – Permitted hours.

No person, firm or corporation shall engage in sandblasting before eight o'clock (8:00) A.M. or after five o'clock (5:00) P.M. of any day, or on Saturdays, Sundays or legal holidays upon any structure which is within one hundred (100) feet of any inhabited single or multifamily residential dwelling.

18.64.090 – Property protection.

No person, firm or corporation shall engage in sandblasting without first protecting adjacent property, public street and pedestrian walkway areas by erecting canvas or other suitable barriers sufficient to protect them from the splashing or blowing of sand or water.

CHAPTER 18.65 DEMOLITION OF HISTORIC LANDMARKS

18.65.010 – Demolition of landmarks prohibited without building permit and funding for replacement structure.

18.65.020 – Appeal to City Council.

18.65.030 – Exception.

18.65.040 – Construction.

CHAPTER 18.65 DEMOLITION OF HISTORIC LANDMARKS

18.65.010 – Demolition of landmarks prohibited without building permit and funding for replacement structure.

- A. No permit to demolish a landmark designated pursuant to Chapter 2.63 of this code may be issued by the Department unless (1) a building permit has been issued for a replacement structure or project for the property involved and (2) the applicant has submitted evidence to the satisfaction of the Planning Commission that a financial commitment has been obtained by the applicant to assure the completion of the structure or project.
- B. Whenever, following action by the Planning Commission pursuant to Subsection 18.65.010.A, a permit to demolish a landmark is either issued or denied by the Department, the Director shall immediately notify the applicant and the Cultural Heritage Commission of such issuance.

18.65.020 – Appeal to City Council.

- A. The applicant or any interested person may appeal a decision to issue or withhold a demolition permit by the Director under Section 18.65.010 to the City Council by filing an appeal therefrom with the City Clerk within ten (10) days of notification of the applicant and the Cultural Heritage Commission under Section 18.65.010 of the decision, and no decision shall be final until expiration of that ten-day period. Such appeal shall be set for hearing by the City Council within twenty-one (21) days of filing the appeal, and the applicant shall not be relieved of the requirements of this section until a final decision is rendered by the City Council.
- B. On appeal, the City Council shall determine, through factual evidence, whether unusual and compelling circumstances, including extreme economic hardship to the applicant, exist in the case before it, and if it so finds, it shall act on the appeal in such a way as to result in granting of the permit which is the subject matter of the appeal.
- C. Both the applicant and appellant, if different from the applicant, shall be notified by mail to the address of the applicant or appellant as indicated on the permit application or appeal of all hearings and decisions made pursuant to this section.

18.65.030 – Exception.

This chapter shall not apply to any landmark which has been determined by the Fire Code Official and Building Official to be imminently dangerous or to constitute an immediate threat to the public health and safety.

18.65.040 – Construction.

Nothing in this chapter shall be construed to be contrary to or inconsistent with the provisions of Chapter 12.75 (commencing with Section 7060) of Division 7 of Title 1 of the California Government Code, and should any provision of this chapter be contrary to or inconsistent with the provisions of that Chapter 12.75, then the provisions of Chapter 12.75 shall prevail.

CHAPTER 18.66 VISITABILITY OF DWELLING UNITS

18.66.010 – Purpose and intent.

18.66.020 – Definitions.

18.66.030 – Applicability of visitability requirements.

18.66.040 – Design and construction requirements.

18.66.050 – Exemption.

CHAPTER 18.66 VISITABILITY OF DWELLING UNITS

18.66.010 – Purpose and intent.

The purpose of this chapter is to provide regulations which will make certain dwelling units visitable by disabled persons. This chapter shall be applicable to new construction of single-family or duplex dwelling units which receive assistance from the City as defined below. Additions or alterations to existing affected dwelling units are exempt.

18.66.020 – Definitions.

For the purpose of this chapter, the following definitions shall apply:

"Affected dwelling unit" means new construction which is a single-family or duplex residential unit, the developer, builder or owner of which receives City assistance for construction. In the case of a duplex, each unit shall be considered an affected dwelling unit subject to this chapter.

"City assistance" means funding in the form of loans or grants from the City, or any agency or program in which the City participates, including, but not limited to:

- A. A building contract or similar contractual agreement involving a City funded program or fund, or a program or fund in which the City participates in decision making on funding;
- B. A real estate purchase, lease, or donation by the City or its agents;
- C. Preferential tax treatment, bond assistance, mortgage assistance, or similar financial advantages from the City or its agents;
- D. Disbursement of Federal or State construction funds including Community Development Block Grant Funds; or
- E. A City contract to provide funding or a financial benefit for housing.

18.66.030 – Applicability of visitability requirements.

Each affected dwelling unit shall meet the requirements of Section 18.66.040.

18.66.040 – Design and construction requirements.

- A. Accessible entrances. An affected dwelling unit must provide at least one (1) accessible entrance that complies with the following:
 - 1. The accessible entrance door must have a minimum net clear opening of thirty-two (32) inches, measured between the face of the door and the stop, when the door is in the ninety degree (90°) open position.
 - 2. A floor or landing shall be provided on each side of the accessible door, measuring forty-four (44) inches at right angles to the plane of the door in its closed position. The floor or landing on the interior side shall be level. The exterior side may be sloped up to one-fourth (1/4) inch per foot.
 - 3. The width of the level area on the side to which the door swings shall extend twenty four (24) inches past the strike edge of the door if the door swings to the outside and eighteen (18) inches past the strike edge if the door swings into the unit.

4. The floor or landing on the exterior side shall not be more than one-half (1/2) inch below the floor level on the inside of the door.
 5. The floor or landing shall not be more than one-half (1/2) inch lower than the threshold of the doorway, except at sliding doors where it may be three-fourths (3/4) inch.
 6. On the interior side of the door only, hardware shall be located between thirty (30) inches and forty four (44) inches above the floor. Hand activated hardware shall be operable with a single effort by lever type hardware, panic bars, push-pull activating bars, or other hardware designed to provide passage without requiring the ability to grasp the opening hardware.
 7. The accessible entrance may be at the front, side or back of the affected dwelling unit.
 8. An accessible route that can be negotiated by a person using a wheelchair shall be provided that connects the accessible entrance to the sidewalk, garage or driveway such that the affected dwelling unit can be entered from the public right-of-way.
- B. Accessible routes within the dwelling unit. An affected dwelling unit must provide an accessible route through the hallways and passageways of the first floor of the dwelling unit. The route must provide a minimum width of thirty-six (36) inches and be level with ramped or beveled changes at door thresholds, except that sunken or raised areas shall be permitted when an accessible route that connects a portion of the living or family room, bathroom, and the accessible entrance door is provided.
- C. Bathroom. At least one (1) bathroom, consisting of at least a toilet and a lavatory, must be provided on the first floor of an affected dwelling unit, using the following standards:
1. Door. Door or opening into the bathroom shall provide a minimum of thirty-two (32) inches nominal clear space, measured between the face of the door and the stop, when the door is in the ninety degree (90°) open position. A thirty-four (34) inch door is acceptable. Door hardware shall meet the requirements of Subsection 18.66.040.A.6 on both sides of the door.
 2. A clear space measuring thirty (30) inches by forty-eight (48) inches inside the bathroom shall be provided. This space may include maneuverable space under fixtures, if provided.
 3. Light switches. A light switch located no higher than forty-two (42) inches above the floor shall be provided inside the bathroom.
 4. Grab bar backing.
 - a. Where the toilet is placed adjacent to a side wall, reinforcement shall be installed on both sides or one side and the back. If reinforcement is installed at the back it shall be installed between thirty-two (32) inches and thirty-eight (38) inches above the floor. The grab bar reinforcement shall be a minimum of six (6) inches nominal in height. The backing shall be a minimum of forty (40) inches in length. Reinforcement installed at the side of the toilet shall be installed thirty-two (32) inches to thirty-eight (38) inches above the floor. The reinforcement shall be installed a maximum of twelve (12) inches from the rear wall and shall extend a minimum of twenty-six (26) inches in front of the water closet stool. The grab bar reinforcement shall be a minimum of six (6) inches nominal in height.
 - b. Where the toilet is not placed adjacent to a side wall, the bathroom shall have provisions for installation of floor mounted, foldaway or similar alternative grab bars.

The reinforced wall or floor shall be capable of supporting a load of at least two hundred fifty (250) pounds.

18.66.050 – Exemption.

- A. When the Building Official determines that compliance with any portion of any regulation under this chapter would create an undue hardship and that equivalent facilitation is available, an exception to that portion of the regulation shall be granted when equivalent facilitation is provided.
- B. When the Building Official determines that compliance with any portion of any regulation under this chapter would create an undue hardship due to topographical conditions of the site and that no equivalent facilitation is available, an exemption to that portion of the regulation shall be granted.

CHAPTER 18.67 CONSTRUCTION AND DEMOLITION RECYCLING PROGRAM

- 18.67.005 – Purpose.
- 18.67.010 – Definitions.
- 18.67.020 – Threshold for covered projects.
- 18.67.030 – Submission of a waste management plan.
- 18.67.040 – Waste diversion deposit.
- 18.67.050 – Administrative fee.
- 18.67.060 – Review of WMP.
- 18.67.070 – Compliance with WMP.
- 18.67.080 – Exemption.
- 18.67.090 – Appeal.

CHAPTER 18.67 CONSTRUCTION AND DEMOLITION RECYCLING PROGRAM

18.67.005 – Purpose.

The State of California through its California Integrated Waste Management Act of 1989, Assembly Bill 939 (“AB 939”) requires that each local jurisdiction in the state divert fifty percent (50%) of discarded materials (base year 1990) from landfills by December 31, 2000. Every city and county, including the City, could face fines up to ten thousand dollars (\$10,000) a day for not meeting the mandated goal. Approximately twenty-two percent (22%) of the City’s solid waste sent to landfills is from construction and demolition activities and the diversion of these materials would have a significant potential for waste reduction and recycling. Reusing and recycling construction demolition materials (“C&D Debris”) is essential to further the City’s efforts to reduce waste and continue to comply with AB 939. C&D Debris reduction and recycling have been proven to reduce the amount of such material which is landfilled, increase worker safety, and be cost effective. To ensure compliance with this chapter and to ensure those contractors with this chapter are not placed at a competitive disadvantage, it is necessary to impose a performance security requirement. (Ordinance ORD-07-0025)

18.67.010 – Definitions.

For the purposes of this chapter, the following definitions shall apply:

- A. "Applicant" means any individual, firm, limited liability company, association, partnership, political subdivision, government agency, municipality, industry, public or private corporation, or any other entity whatsoever who applies to the City for the applicable permits to undertake any construction, demolition, or renovation project within the City.
- B. "Class III landfill" means a landfill that accepts nonhazardous resources such as household, commercial, and industrial waste, resulting from construction, remodeling, repair, and demolition operations. A Class III landfill must have a solid waste facilities permit from the California Integrated Waste Management Board (CIWMB) and is regulated by an enforcement agency (as defined in Public Resources Code Section 40130).
- C. "Construction" means the building of any facility or structure or any portion thereof including any tenant improvements to an existing facility or structure.
- D. "Construction and demolition debris" (C and D debris) means building materials and solid waste resulting from construction, remodeling, repair, cleanup, or demolition operations that are not hazardous as defined in California Code of Regulations, Title 22, Sections 66261.3, et seq. This term includes, but is not limited to, asphalt, concrete, portland cement concrete, brick, lumber, gypsum wallboard, cardboard, and other associated packaging, roofing material, ceramic tile, carpeting, plastic pipe and steel. The material may be commingled with rock, soil, tree stumps, and other vegetative matter resulting from land clearing and landscaping for construction or land development projects.
- E. "C and D recycling center" means a facility that receives only C and D material that has been separated for reuse prior to receipt, in which the residual (disposed) amount of waste in the material is less than ten percent (10%) of the average weight of material separated for reuse received by the facility over a one-month period.
- F. "City-sponsored project" means a project constructed by the City or a project receiving fifty percent (50%) or more of its financing from the City.
- G. "Covered project" shall have the meaning set forth in Section 18.67.020.

- H. "Deconstruction" means the careful dismantling of buildings and structures in order to salvage as much material as possible.
- I. "Demolition" means the decimating, razing, ruining, tearing down or wrecking of any facility, structure, pavement or building, whether in whole or in part, whether interior or exterior.
- J. "Disposal" means the final deposition of construction and demolition or inert material, to a Class III landfill.
- K. "Divert" means to use material for any purpose other than disposal in a landfill or transformation facility.
- L. "Diversion requirement" means the diversion of a percentage of the total construction and demolition debris generated by a project via reuse or recycling, unless the applicant has been granted an exemption pursuant to Section 18.67.070 in which case the diversion requirement shall be the maximum feasible diversion rate established by the Director in relation to the project.
- M. "Enforcement agency (EA)" means an enforcement agency as defined in Public Resources Code Section 40130.
- N. "Inert solids/inert waste" means nonliquid solid resources including, but not limited to, soil and concrete, that do not contain hazardous waste or soluble pollutants at concentrations in excess of water quality objectives established by a regional water board pursuant to Division 7 (Sections 13000, et seq.) of the California Water Code and does not contain significant quantities of decomposable solid resources.
- O. "Project" means any activity which requires an application for a building or demolition permit or any similar permit from the City pursuant to Section 18.67.020.
- P. "Recycling" means the process of collecting, sorting, cleansing, treating, and reconstituting materials for the purpose of using the altered form in the manufacture of a new product. Recycling does not include burning, incinerating, or thermally destroying solid waste.
- Q. "Renovation" means any change, addition or modification in an existing structure.
- R. "Reuse" means the use, in the same or similar form as it was produced, of a material which might otherwise be discarded.
- S. "Solid waste" means all putrescible and nonputrescible solid, semisolid, and liquid wastes, including garbage, trash, refuse, paper, rubbish, ashes, industrial wastes, demolition and construction wastes, abandoned vehicles and parts thereof, discarded home and industrial appliances, dewatered, treated, or chemically fixed sewage sludge which is not hazardous waste, manure, vegetable or animal solid and semisolid wastes, and other discarded solid and semisolid wastes. "Solid waste" does not include any of the following wastes:
 - 1. Hazardous waste, as defined in Public Resources Code Section 40141;
 - 2. Radioactive waste regulated pursuant to the Radiation Control Law [Chapter 8 (commencing with Section 114960) of Part 9 of Division 104 of the Health and Safety Code];
 - 3. Medical waste regulated pursuant to the Medical Waste Management Act [Part 14 (commencing with Section 117600) of Division 104 of the Health and Safety Code].
- T. "Waste management plan" (WMP) means a completed waste management plan form, approved by the City for the purpose of compliance with this chapter, submitted by the applicant for any covered or noncovered project.

- U. "Waste management plan attachments" means a list of permitted haulers, reuse facilitators, disposal and recycling facilities, conversions for mass to weight, and green building material suggestions.

18.67.020 – Threshold for covered projects.

A. Private projects.

1. The following threshold will apply to projects for which a demolition or building permit is issued after October 1, 2007, but before January 1, 2008: all construction projects the total valuation of which are, or are projected to be, seventy-five thousand dollars (\$75,000.00) or greater and all demolition projects of any valuation, ("covered projects") shall be required to divert at least sixty percent (60%) of all project-related construction and demolition material in compliance with this chapter.
2. The following threshold will apply to projects for which a demolition or building permit is issued on or after January 1, 2008, but before January 1, 2014: all construction projects the total valuation of which are, or are projected to be, fifty thousand dollars (\$50,000.00) or greater and all demolition projects of any valuation, ("covered projects") shall be required to divert at least sixty percent (60%) of all project-related construction and demolition material in compliance with this chapter.
3. The following threshold will apply to projects for which a demolition or building permit is issued on or after January 1, 2014: all newly constructed buildings, building additions of one thousand (1,000) square feet or greater, and/or building alterations with a permit valuation of \$200,000 or above and all demolition projects of any valuation ("covered projects") shall be required to divert at least sixty percent (60%) of all project-related construction and demolition material in compliance with this chapter.

- B. All City-sponsored construction, demolition and renovation projects shall be subject to this chapter, and consequently, shall be considered covered projects.

- C. Compliance with this chapter shall be included as a condition of approval on any construction or demolition permit issued for a covered project.

18.67.030 – Submission of a waste management plan.

- A. Applicants for construction or demolition permits involving a covered project shall complete and submit a WMP, on a WMP form approved by the City for this purpose, as part of the application packet for the construction or demolition permit. The completed WMP shall indicate all of the following:

1. The estimated volume or weight of the project C and D debris, by material type, to be generated;
2. The maximum volume or weight of such materials that can feasibly be diverted via reuse or recycling. No more than twenty percent (20%) of the sixty percent (60%) diversion rate can be achieved through the recycling or reuse of inert materials unless applicant can demonstrate to the satisfaction of the Director that sufficient structural materials do not exist for recycling or that forty percent (40%) diversion of total waste through non-inert materials is not feasible.
3. The vendor or facility where the applicant proposes to use to collect or receive that material; and
4. The estimated volume or weight of C and D debris that will be landfilled in Class III landfills.

- B. Calculating volume and weight of material. In estimating the volume or weight of materials identified in the WMP, the applicant shall use the conversion rates approved by the City for this purpose.
- C. Deconstruction. In preparing the WMP, applicants for demolition permits involving the removal of all or part of an existing structure shall consider deconstruction to the maximum extent feasible, and shall make the materials generated thereby available for salvage prior to landfilling. Deconstruction can be used to meet the sixty percent (60%) diversion requirement provided it is accounted for in the WMP.

18.67.040 – Waste diversion deposit.

The project applicant shall submit a waste diversion deposit with the WMP. The amount of the performance security shall be calculated as a percentage of the total project valuation as set forth in the schedule of fees and charges established by City Council resolution, provided, however, that the minimum and maximum fees shall be as set forth in the schedule of fees and charges established by City Council resolution.

18.67.050 – Administrative fee.

The project applicant shall submit an administrative fee with the WMP. The amount of the administrative fee shall be as set forth in the schedule of fees and charges established by City Council resolution.

18.67.060 – Review of WMP.

- A. Notwithstanding any other provisions of this title, no building or demolition permit shall be issued for any covered project unless and until the Director has reviewed the WMP. Approval shall not be required, however, where an emergency demolition is required to protect public health or safety. The Director shall only approve a WMP if he or she first determines that all of the following conditions have been met:
 - 1. The WMP provides all of the information set forth in Section 18.67.030.
 - 2. The WMP indicates that at least sixty percent (60%) of all C and D material generated by the project will be diverted or an exemption has been approved pursuant to Section 18.67.080.
 - 3. The applicant has submitted an appropriate waste diversion deposit in compliance with Section 18.67.040.

If the Director determines that these conditions have been met, he or she shall mark the WMP "Approved," return a copy of the WMP to the applicant.

- B. If the Director determines that the WMP fails to meet the conditions specified in Subsection 18.67.060.A, he or she shall either:
 - 1. Return the WMP to the applicant marked "Denied," including a statement of reasons.
 - 2. Return the WMP to the applicant marked "Further Explanation Required."

If the applicant determines during the course of the project that the estimated tonnage of material to be generated and or recovered from the project is substantially different from the WMP, applicant shall submit an addendum to the original WMP.

18.67.070 – Compliance with a WMP.

- A. Within thirty (30) days after the completion of any covered project, the applicant shall submit to the Director documentation that it has met the diversion requirement for the project. Applicant shall provide a summary of efforts used to meet the diversion requirement and also provide the following documentation:
1. Receipts from the vendor or facility which collected or received each material showing the actual weight or volume of that material;
 2. Weight slips/count of material salvaged or reused in current project;
 3. A copy of the previously approved WMP for the project adding the actual volume or weight of each material diverted and landfilled;
 4. Any additional information the applicant believes is relevant to determining its efforts to comply in good faith with this chapter.
- B. Weighing of wastes. Applicants shall make reasonable efforts to ensure that all C and D debris diverted or landfilled are measured and recorded using the most accurate method of measurement available. To the extent practical, all C and D debris shall be weighted by measurement on scales. Such scales shall be in compliance with all State and County regulatory requirements for accuracy and maintenance. For C and D debris for which weighing is not practical due to small size or other considerations, a volumetric measurement shall be used. For conversion of volumetric measurements by weight, the applicant shall use the standardized conversion rates approved by the City for this purpose.
- C. The Director shall review the information submitted under Subsection 18.67.070.A to determine whether the applicant has complied with the diversion requirement as follows:
1. If the Director determines that the applicant has fully complied with the diversion requirement applicable to the project, he or she shall cause the full waste diversion deposit to be released to the applicant.
 2. If the Director determines that the diversion requirement has not been met, he or she shall return only that portion of the performance security equivalent to the portion of C and D debris actually diverted compared to the portion that should have been diverted according to the WMP. Any portion of the waste diversion deposit not released to the applicant shall be forfeited to the City, and shall be used to further develop environmental sustainability efforts within the City. If the Director determines that the applicant has fully failed to comply with the diversion requirement or if the applicant fails to submit the documentation required by Subsection 18.67.070.A within the required time period, then the entire waste diversion deposit shall be forfeited to the City. All forfeited waste diversion deposits shall be used to further develop environmental sustainability efforts within the City.

18.67.080 – Exemption.

- A. Application. If an applicant believes it is infeasible to comply with the diversion requirements of this chapter due to the circumstances delineated in this section, the applicant may apply for an exemption at the time that he or she submits the required WMP. Exemptions may be granted based on the following considerations:
1. An emergency situation exists;
 2. Contamination by hazardous substances;
 3. Low recyclability of specific materials;
 4. Initial tenant or occupant improvements for projects in shell buildings; and

5. Excavated soil and land-clearing debris.

The applicant shall indicate on the WMP the maximum rate of diversion he or she believes is feasible for each material and the specific circumstances that he or she believes make it infeasible to comply with the diversion requirement.

- B. Meeting with the Director. The Director shall review the information supplied by the applicant and may meet with the applicant to discuss possible ways of meeting the diversion requirement. The Director may request that staff from the Department of Public Works Environmental Services Bureau attend this meeting or may require the applicant to request a separate meeting with Department of Public Works Environmental Services Bureau staff. Based on the information supplied by the applicant and, if applicable, Department of Public Works Environmental Services Bureau staff, the Director shall determine whether it is possible for the applicant to meet the diversion requirement.
- C. Granting of exemption. If the Director determines that it is infeasible for the applicant to meet the diversion requirement due to unique circumstances, he or she shall determine the maximum feasible diversion rate for each material and shall indicate this rate on the WMP submitted by the applicant. The Director shall return a copy of the WMP to the applicant marked "Approved Exemption".
- D. Denial of exemption. If the Director determines that it is possible for the applicant to meet the diversion requirement, he or she shall inform the applicant in writing. The applicant shall have thirty (30) days to resubmit a WMP form in full compliance with Section 18.67.030. If the applicant fails to resubmit the WMP, or if the resubmitted WMP does not comply with Section 18.67.030, the Director shall deny the WMP.

18.67.090 – Appeal.

The applicant or any interested person may appeal to a Hearing Officer from any ruling of the Director made pursuant to this chapter in accordance with Section 18.67.070. Notice of any appeal from the ruling of the Director must be filed within ten (10) days of the date that such ruling is made. The decision of the Hearing Officer upon such appeal, relative to any matter within the jurisdiction of the Director, shall be final and shall not be appealable to the City Council or to any other City body or official.

CHAPTER 18.68 EARTHQUAKE HAZARD REGULATIONS

- 18.68.010 – Purpose.
- 18.68.020 – Scope.
- 18.68.021 – Definitions.
- 18.68.022 – Symbols and notations.
- 18.68.023 – General requirements.
- 18.68.024 – Material requirements.
- 18.68.025 – Quality control.
- 18.68.026 – Allowable design values.
- 18.68.027 – Analysis and design.
- 18.68.028 – Detailed system design requirements.
- 18.68.030 – Prima facie hazard grading.
- 18.68.040 – Special and intermediate hazards.
- 18.68.050 – Priority and method of grading.
- 18.68.060 – Calculation of actual lateral force capacity VCAP.
- 18.68.070 – Hazardous grading and dates of corrective action.
- 18.68.080 – Hazardous grading subject to change.
- 18.68.090 – Notice of corrective action.
- 18.68.100 – Application for order of abatement of nuisance.
- 18.68.110 – Hearing by Board.
- 18.68.120 – Appeals to City Council.
- 18.68.130 – Owner responsibility to demolish structure.
- 18.68.135 – Landmark structures—Alternatives to demolition.
- 18.68.140 – Notice of pending order of demolition.
- 18.68.150 – Owner responsibility to accomplish hazard reduction measures.
- 18.68.160 – Jurisdiction of Board or Council over certain cases.
- 18.68.170 – Hearing—Failure of owner to proceed in good faith.
- 18.68.180 – Notification to owners of buildings four stories or more in height.
- 18.68.190 – Notice of county recorder.
- 18.68.200 – Figure No. A-23-1.
- 18.68.210 – Tables A-23-A through A-23-F.
- 18.68.220 – Standard No. 24-40, in-place masonry shear tests.
- 18.68.221 – Standard No. 24-41, tests of anchors in unreinforced masonry walls.
- 18.68.222 – Standard No. 24-42, pointing of unreinforced masonry walls.

CHAPTER 18.68 EARTHQUAKE HAZARD REGULATIONS

18.68.010 – Purpose.

The purpose of this chapter is to define a systematic procedure for identifying and assessing earthquake generated hazards associated with certain existing structures within the City and to develop a flexible, yet uniform and practical procedure for correcting or reducing those hazards to tolerable hazard levels. It is not the purpose of this chapter to preclude or affect the assessment and abatement, pursuant to existing laws, of other hazards which may involve fire, exit, plumbing, electrical, and other such problems with existing buildings.

The provisions of this chapter are intended as minimum standards for structural seismic resistance established primarily to reduce the risk of life loss or injury. Compliance with these standards will not necessarily prevent loss of life or injury or prevent earthquake damage to rehabilitated buildings.

18.68.020 – Scope.

This chapter shall apply to all Type I, Type II and Type III buildings located within the City and built prior to January 9, 1934.

18.68.021 – Definitions.

For the purpose of this chapter, the following definitions shall apply:

"Collar joint" is the vertical space between adjacent wythes and may contain mortar.

"Crosswall" is a wall that meets the requirements of Subsection 18.68.027.D.3. A crosswall is not a shear wall.

"Crosswall shear capacity" is the length of the crosswall times the allowable shear value, $v_c L_0$.

"Diaphragm edge" is the intersection of the horizontal diaphragm and a shear wall.

"Diaphragm shear capacity" is the depth of the diaphragm times the allowable shear value, $v_u D$.

"Flexible diaphragm" is a diaphragm of wood construction or other construction of similar flexibility.

"Normal wall" is a wall perpendicular to the direction of seismic forces.

"Open front" is an exterior building wall plane on one side only without vertical elements of the lateral force resisting system in one or more stories.

"Pointing" is the partial reconstruction of the bed joints of a URM wall as defined in Standard No. 24-42. (See Section 18.68.222.)

"UBC" is the 1988 Edition of the Uniform Building Code as published by the International Conference of Building Officials.

"UBC standard" is the 1988 Edition of the Uniform Building Code standard as published by the International Conference of Building Officials.

"Unreinforced masonry bearing wall" is URM wall which provides the vertical support for a floor or roof for which the total superimposed load exceeds one hundred (100) pounds per linear foot of wall.

"Unreinforced masonry (URM) wall" is a masonry wall in which the area of reinforcing steel is less than twenty five percent (25%) of the minimum required by the UBC for reinforced masonry.

"Yield story drift" is the lateral displacement of one level relative to the level above or below at which yield stress is first developed in a frame member.

18.68.022 – Symbols and notations.

For the purposes of this chapter, the following symbols and definitions shall apply:

A = Area of unreinforced masonry pier, square inches.

A_b = Area of the bed joints above and below the test specimen for each in place shear test.

C_p = Numerical coefficient as specified in UBC Section 2312(g) and given in UBC Table 23-P and in Table A-23-A.

D = In plane width dimension of pier, inches, or depth of diaphragm, feet.

DCR = Demand capacity ratio specified in Subsection 18.68.027.D.

F_{wx} = Force applied to a wall at level x , pounds.

H = Lease clear height of opening on either side of pier, inches.

h/t = Height/thickness ratio of URM wall. Height h is measured between wall anchorage levels, and/or slab on grade.

L = Span of diaphragm between shear walls, or span between shear wall and open front, feet.

L_c = Length of crosswall, feet.

L_i = Effective span for an open front building specified in Subsection 18.68.027.D.8, feet.

PD = Superimposed dead load at the top of the pier under consideration, pounds.

P_{D+L} = Actual dead plus live load in place at the time of testing, pounds.

P_w = Weight of wall, pounds.

$V_a = v_a A$, the allowable shear in any URM pier, pounds.

V_{cb} = Total shear capacity of crosswalls in the direction of analysis immediately below the diaphragm level being investigated, $S v_c L_o$, pounds.

V_{ca} = Total shear capacity of crosswalls in the direction of analysis immediately above the diaphragm level being investigated, $S v_c L_o$, pounds.

V_r = Pier rocking shear capacity of any URM wall or wall pier, pounds.

V_{wx} = Total shear force resisted by a shear wall at the level under consideration, pounds.

V_p = Shear force assigned to a pier on the basis of its relative shear rigidity, pounds.

$V_{s\sub}$ = Shear force assigned to a spandrel on the basis of the shear forces in the adjacent wall piers and tributary dead plus live loads.

V_{test} = Load in pounds at incipient cracking for each in-place masonry shear test per Standard No. 24-40. (See Section 18.68.220.)

v_a = Allowable shear stress for unreinforced masonry, psi.

v_c = Allowable shear value for a crosswall sheathed with any of the materials given in Tables A-23-C or A-23-D, pounds per foot.

v_t = Mortar shear strength as specified in Subsection 18.68.024.C.3.d.

v_{t0} = Mortar shear test values as specified in Subsection 18.68.024.C.3.d.

v_u = Allowable shear value for a diaphragm sheathed with any of the materials given in Tables A-23-C or A-23-D, pounds per foot.

$\Sigma v_u D$ = Sum of diaphragm shear capacities of both ends of the diaphragm.

$\Sigma\Sigma v_u D$ = For diaphragms coupled with crosswalls $\Sigma\Sigma v_u D$ includes the sum of shear capacities of both ends of diaphragms coupled at and above the level under consideration.

W_d = Total dead load tributary to a diaphragm, pounds.

ΣW_d = Total dead load tributary to all of the diaphragms coupled at and above the level under consideration, pounds.

W_w = Total dead load of an unreinforced masonry wall above the level under consideration or above an open front of a building, pounds.

W_{wx} = Dead load of a URM wall assigned to level x halfway above and below the level under consideration.

18.68.023 – General requirements.

- A. General. All buildings shall have a seismic resisting system conforming with UBC Section 2303(b), except as modified by this chapter.
- B. Alterations and repairs. Alterations and repairs required to meet the provisions of this chapter shall comply with all other applicable requirements of this title unless specifically provided for in this chapter.
- C. Requirements for plans. The following construction information shall be included in the plans required by this chapter:
 1. Dimensioned floor and roof plans showing existing walls and the size and spacing of floor and roof framing members and sheathing materials. The plans shall indicate all existing and new crosswalls and their materials of construction. The location of the crosswalls and their openings shall be fully dimensioned or drawn to scale on the plans.
 2. Dimensioned wall elevations showing openings, piers, wall classes as defined in Subsection 18.68.024.C.3(f), thicknesses, heights, wall shear test locations, and cracks or damaged portions requiring repairs. The general condition of the mortar joints shall be noted and if and where the joints require pointing. Where the exterior face is veneer, the type of veneer, its thickness and its bonding and/or ties to the structural wall masonry shall also be reported.
 3. The type of interior wall and ceiling surfaces.
 4. The extent and type of existing wall anchorage to floors and roof when utilized in the design.
 5. The extent and type of parapet corrections which were previously performed, if any.

6. Repair details, if any, of cracked or damaged unreinforced masonry walls required to resist forces specified in this chapter.
7. All other plans, sections, and details necessary to delineate required retrofit construction including those items in Section 18.68.028.

18.68.024 – Material requirements.

- A. General. All materials permitted by this chapter, including their appropriate allowable design values and those existing configurations of materials specified herein, may be utilized to meet the requirements of this chapter.
- B. Existing materials. All existing materials utilized as part of the required force resisting system shall be in sound condition or shall be removed and replaced with new material.
- C. Existing unreinforced masonry.
 1. General. All unreinforced masonry walls utilized to carry vertical loads or seismic forces parallel and perpendicular to the wall plane shall be tested as specified in this subsection. All masonry that does not meet or exceed the minimum standards established by this chapter shall be removed and replaced by new materials or alternatively shall have its structural functions replaced by new materials and anchored to supporting elements.
 2. Lay-up of walls. The facing and backing shall be bonded so that not less than ten percent (10%) of the exposed face area is composed of solid headers extending not less than four (4) inches into the backing. The clear distance between adjacent full-length headers shall not exceed twenty-four (24) inches vertically or horizontally. Where the backing consists of two (2) or more wythes, the headers shall extend not less than four (4) inches into the most distant wythe or the backing wythes shall be bonded together with separate headers whose area and spacing conform to the foregoing. Wythes of walls not bonded as described above shall be considered as veneer. Veneer wythes shall not be included in the effective thickness used in calculating the height to thickness and the shear capacity of the wall.
 3. Mortar.
 - a. Tests. The quality of mortar in all masonry walls shall be determined by performing in-place shear tests in accordance with Standard No. 24-40. Alternative methods of testing may be approved by the Building Official.
 - b. Location of tests. The shear tests shall be taken at locations representative of the mortar conditions throughout the entire building, taking into account variations in workmanship at different building height levels, variations in weathering of the exterior surfaces, and variations in the condition of the interior surfaces due to deterioration caused by leaks and condensation of water and/or by the deleterious effects of other substances contained within the building. The exact test location shall be determined at the building site by the engineer in responsible charge of the structural design work. An accurate record of all such tests and their location in the building shall be recorded and these results shall be submitted to the Building and Safety Bureau for approval as part of the structural analysis.
 - c. Number of tests. The minimum number of tests per class shall be as follows:
 - i. At each of both the first and top stories, not less than two (2) tests per wall or line of wall elements providing a common line of resistance to lateral forces.

- ii. At each of all other stories, not less than one (1) test per wall or line of wall elements providing a common line of resistance to lateral forces.
 - iii. In any case, not less than one (1) test per one thousand five hundred (1,500) square feet of wall surface nor less than a total of eight (8).
- d. Minimum quality mortar.
- Mortar shear test values, v_{to} , in psi shall be obtained for each in-place shear test in accordance with the following equation:
$$v_{to} = (V_{test} - P_D + L)/A_b \text{ (024-1)}$$
- i. Individual unreinforced masonry walls with consistently less than thirty (30) psi shall be removed or entirely repointed and retested.
 - ii. The mortar shear strength, v_t , is the value in psi that is exceeded by eighty percent (80%) of all of the mortar shear test values, v_{to} .
- e. Collar joints. The collar joints shall be inspected at the test locations during each in-place shear test, and estimates of the percentage of the surfaces of adjacent wythes which are covered with mortar shall be reported along with the results of the in-place shear tests.
- f. Unreinforced masonry classes. All existing unreinforced masonry shall be categorized into one (1) or more classes based on shear strength, quality of construction, state of repair, deterioration, and weathering. A class shall be characterized by the allowable masonry shear stress determined in accordance with Subsection 18.68.026.B. Classes shall be defined for whole walls, not for small areas of masonry within a wall.
- g. Pointing. All deteriorated mortar joints in unreinforced masonry walls shall be pointed according to Standard No. 24-42. Nothing shall prevent pointing with mortar of all the masonry wall joints before the tests are made.

18.68.025 – Quality control.

- A. Pointing. All preparation and mortar pointing shall be done with special inspection.

EXCEPTION: At the discretion of the Building Official, incidental pointing may be performed without special inspection.

- B. Masonry shear tests. In-place masonry shear tests shall comply with Standard No. 24-40.
- C. Existing wall anchors. Existing wall anchors utilized as all or part of the required tension anchors shall be tested in pullout according to Standard No. 24-41. The minimum number of anchors tested shall be four (4) per floor, with two (2) tests at walls with joists framing into the wall and two (2) tests at walls with joists parallel to the wall, but not less than ten percent (10%) of the total number of existing tension anchors at each level.
- D. New bolts. One-fourth (1/4) of all new shear bolts and combined tension and shear bolts in unreinforced masonry walls shall be tested according to Standard No. 24-41.

EXCEPTION: Special inspection may be provided during installation in lieu of testing.

18.68.026 – Allowable design values.

- A. Allowable values.

1. Allowable values for existing materials are given in Table A-23-C and for new materials in Table A-23-D.
2. Allowable values not specified in this chapter shall be as specified elsewhere in this title.

Masonry shear. The allowable unreinforced masonry shear stress, V_a , shall be determined for each masonry class from the following equation: $v_a = 0.1v_t + 5P_D/A$ (026-1)

The mortar shear test value, v_t , shall be determined in accordance with Subsection 18.68.024.C.3, and not exceed one hundred (100) psi for the determination of V_a .

The one-third (1/3) increase in allowable values of the Uniform Building Code is not allowed for v_a .

- B. Masonry compression. The one-third (1/3) increase in allowable stress of the Uniform Building Code is allowed.
- C. Masonry tension. Unreinforced masonry shall be assumed as having no tensile capacity.
- D. Existing tension anchors. The allowable resistance values of the existing anchors shall be forty percent (40%) of the average of the tension tests of existing anchors having the same wall thickness and joist orientation. The one-third (1/3) increase in allowable stress of the Uniform Building Code is not allowed for existing tension anchors.
- E. Foundations. For existing foundations new total loads may be increased over existing dead load by twenty-five percent (25%). New total dead load plus live load plus seismic may be increased over existing dead load plus live load by fifty percent (50%). Higher values may be justified only in conjunction with a geotechnical investigation.

18.68.027 – Analysis and design.

- A. General. Except as modified herein, the analysis and design relating to the structural alteration of existing buildings shall be in accordance with this title.
- B. Selection of procedure. Buildings shall be analyzed by the general procedure of Subsection 18.68.027.C which is based on UBC Chapter 23 or, when applicable, buildings may be analyzed by the special procedure of Subsection 18.68.027.D.
- C. General procedure.
 1. Basis for design. The minimum design seismic forces shall be those determined in accordance with the static lateral force procedure of Subsection 18.68.027.C.2 or the dynamic lateral force procedure of Subsection 18.68.027.C.3.

Minimum design lateral forces – static force procedure. Buildings shall be analyzed to resist minimum lateral forces assumed to act nonconcurrently in the direction of each of the main axes of the structure in accordance with the following:

$V_B = \phi \beta CW$ (027-1) where

- V_B = Design base shear
- W = Total seismic dead load of the building
- β = Building type coefficient given in Table A-23-E
- ϕ = Occupancy Load Factor from Table A-23-F
- $C = 0.059/T^{2/3}$
- T = Building period, in seconds, of the structure in the direction of consideration

- The product of $\phi \beta C$ need not exceed 0.13. The building period may be calculated in accordance with the 1988 UBC Method A or Method B. The value of C need not exceed 0.13. The distribution of the design base shear over the height of the building is to be the same as that specified by the 1988 UBC.
2. Minimum design lateral forces – dynamic force procedure. Dynamic analysis procedures when used to determine the seismic demand on the building shall conform with Chapter 23 of the 1988 UBC. Except where approved situs specific response spectra are developed, ground motions used in the analysis shall be consistent with the October, 1988 Seismic Safety Element to the City of Long Beach general plan and applied as follows:
 - a. If the analysis utilizes the modal superposition spectral response approach, the five percent (5%) damped spectrum for the appropriate soil at the building site shall be used as the input ground motions. The response of the building shall be normalized by the ratio of the base shear determined from the equivalent static force approach to the base shear determined from the spectral response approach.
 - b. If the analysis utilizes a time history (linear elastic or nonlinear) approach, an approved synthetic acceleration time history shall be constructed which is consistent with the five percent (5%) damped spectrum for the appropriate soil at the building site. Such an acceleration time history must have a response spectrum which closely matches the five percent (5%) damped spectrum with no spectral ordinate dipping more than ten percent (10%) below the target spectrum.
 3. Lateral forces on elements of structures. Parts or portions of structures shall be analyzed as required in UBC Chapter 23.

EXCEPTIONS:

- a. Unreinforced masonry walls for which height to thickness ratios do not exceed ratios set forth in Table A-23-B need not be analyzed for out-of-plane loading. Unreinforced masonry walls which exceed the allowable h/t ratios of Table A-23-B shall be braced according to Subsection 18.68.028.E.
 - b. Parapets complying with Subsection 18.68.028.F need not be analyzed for out-of-plane loading.
4. Shear walls (in-plane loading). Shear walls shall comply with Subsection 18.68.027.E.
- D. Special procedure.
1. Limits for the application of Subsection 18.68.027.D. The special procedure of this subsection may only be applied to buildings with the following characteristics:
 - a. Flexible diaphragms at all levels above the base of structure.
 - b. A maximum of six (6) stories above the base of the building.
 - c. The vertical elements of the lateral force resisting system shall consist predominately of masonry or concrete shear walls.
 - d. New vertical elements of the lateral force resisting system consisting of steel braced frames or special moment resisting frames shall have a maximum overall height-to-length ratio of 1.5 to 1.

- e. A minimum of two (2) lines of vertical elements of the lateral force resisting system parallel to each axis of the building except for single story buildings with an open front on one (1) side only. (See Subsection 18.68.027.D.8 for open front buildings.)
2. Lateral forces on elements of structures. With the exception of the diaphragm provisions in Subsection 18.68.027.D, elements of structures shall comply with Subsection 18.68.027.C.4.
3. Crosswalls. Crosswalls shall meet the requirements of this subsection.
 - a. Crosswall definition. A crosswall is a wood-framed wall sheathed with any of the materials described in Tables A-23-C or A-23-D. Spacing of crosswalls shall not exceed forty (40) feet on center measured perpendicular to the direction of consideration, and shall be placed in each story of the building. Crosswalls shall extend the full story height between diaphragms.

EXCEPTIONS:

- i. Crosswalls need not be provided at all levels in accordance with Subsection 18.68.027.D.4.b.iv.
 - ii. Existing crosswalls need not be continuous below a wood diaphragm at/or within four feet of grade provided:
 - aa. Shear connection requirements of Subsection 18.68.027.D.5 are satisfied at all edges of the diaphragm.
 - bb. Crosswalls with total shear capacity of 0.08 (W_d) interconnect the diaphragm to the foundation.
 - cc. The demand/capacity ratio of the diaphragm between the crosswalls that are continuous to their foundations shall be calculated as:

$$DCR = [0.33W_D + V_{ca}] / 2V_u D; lf-.; (027-2)$$
 and DCR shall not exceed 2.5.
 - b. Crosswall shear capacity. Within any forty (40) feet measured along the span of the diaphragm, the sum of the crosswall shear capacities shall be at least thirty percent (30%) of the diaphragm shear capacity of the strongest diaphragm at or above the level under consideration.
 - c. Existing crosswalls. Existing crosswalls shall have a length to height ratio between openings of not less than 1.5. Existing crosswall connections to diaphragms need not be investigated as long as the crosswall extends to the framing of the diaphragm above and below.
 - d. New crosswalls. New crosswall connections to the diaphragm shall develop the crosswall shear capacity. New crosswalls shall have the capacity to resist an overturning moment equal to the crosswall shear capacity times the story height. Crosswall overturning moments need not be cumulative over more than two (2) stories.
 - e. Other crosswall systems. Other systems such as special moment resisting frames may be used as crosswalls provided that the yield story drift does not exceed one (1) inch in any story.
4. Wood diaphragms.
 - a. Acceptable diaphragm span. A diaphragm is acceptable if the point (L, DCR) on Figure A-23-1, falls within Regions 1, 2, or 3.

- b. Demand-capacity ratios. Demand-capacity ratios shall be calculated for the diaphragm according to the following formulas:
- i. For a diaphragm without qualifying crosswalls at levels immediately above or below:
 $DCR = 0.33W_d / \sum v_u D$ (027-3)
 - ii. For a diaphragm in a single-story building with qualifying crosswalls:
 $DCR = 0.33W_d / \sum v_u D + V_{cb}$ (027-4)
 - iii. For diaphragms in a multi-story building with qualifying crosswalls in all levels:
 $DCR = 0.33 W_d / \sum v_u D + V_{cb}$ (027-5)
- DCR shall be calculated at each level for the set of diaphragms at and above the level under consideration.
- iv. For a roof diaphragm and the diaphragm directly below if coupled by crosswalls
 $DCR = 0.33(W_d / \sum \sum v_u D)$ (027-6)
- c. Chords. An analysis for diaphragm flexure need not be made and chords need not be provided.
- d. Collectors. An analysis of diaphragm collector forces shall be made for the transfer of diaphragm edge shears into vertical elements of the lateral force resisting system. Collector forces may be resisted by new or existing elements.
- e. Diaphragm openings.
- i. Diaphragm forces at corners of openings shall be investigated and shall be developed into the diaphragm by new or existing materials.
 - ii. In addition to calculating demand capacity ratios per Subsection 18.68.027.D.4.b, the demand capacity ratio of the portion of the diaphragm adjacent to an opening shall be calculated using the opening dimension as the span.
 - iii. Where an opening occurs in the end quarter of the diaphragm span, the quantity $v_u d$ for the demand capacity ratio calculation shall be based on the net depth of the diaphragm.
5. Shear transfer. Diaphragms shall be connected to shear walls with connections capable of developing a minimum force given by the lesser of the following formulas:
- $$V = 0.20C_p W_d$$
- (027-7)
-
- using the
- C_p
- values in Table A-23-A, or
-
- $V = v_u D$
- (027-8)

6. Shear walls (in plane loading) – special procedure.

- a. Wall story force. The wall story force distributed to a shear wall at any diaphragm level shall be the lesser value calculated as:
 - i. For buildings without crosswalls, $F_{wx} = 0.13(W_{wx} + W_d/2)$ (027-9) but need not exceed $F_{wx} = 0.13W_{wx} + v_u D$ (027-10)
 - ii. For buildings with crosswalls in all levels:
 $F_{wx} = 0.10(W_{wx} + W_d/2)$ (027-11)
 but need not exceed

$$F_{wx} = 0.10(W_{wx} + \sum W_d(v_u D / \sum \sum v_u D))(027-12)$$

and need not exceed

$$F_{wx} = 0.10W_{wx} + v_u D(027-13)$$

- b. Wall story shear. The wall story shear shall be the sum of the wall story forces at and above the level of consideration.
 $V_{wx} = \sum F_{wx}$ (027-14)
 - c. Shear wall analysis. Shear walls shall comply with Subsection 18.68.027.E.
 - d. Moment frames. Moment frames used in place of shear walls shall be designed as required in UBC Chapter 23 except that the forces shall be as specified in Subsection 18.68.027.D.6.a and the interstory drift shall be limited to 0.005 except as further limited in Subsection 18.68.027.E.3.b.
7. Out of plane forces – URM walls.
- a. Allowable URM wall height to thickness ratios. The provisions of Subsection 18.68.027.C.4 are applicable except the allowable h/t ratios given in Table A-23-B shall be determined from Figure A-23-1 as follows:
 - i. In Region 1, h/t ratios for "buildings with crosswalls" may be used if qualifying crosswalls are present in all stories.
 - ii. In Region 2, h/t ratios for "buildings with crosswalls" may be used whether or not qualifying crosswalls are present.
 - iii. In Region 3, h/t ratios for "all other buildings" shall be used whether or not qualifying crosswalls are present.
 - b. Walls with diaphragms in different regions. When diaphragms above and below the wall under consideration have DCRs in different regions of Figure A-23-1, the lesser h/t ratio shall be used.
8. Buildings with open fronts. A building with an open front on one (1) side shall have crosswalls parallel to the open front and shall be designed by the following procedure:
- a. Effective diaphragm span, L_i , for use in Figure No. A-23-1 shall be determined in accordance with the following formula:
 $L_i = 2[(W_w/W_d) \cdot L + L](027-15)$
 - b. Diaphragm demand/capacity ratio shall be calculated as:
 $DCR = 0.33(W_d + W_w)/[(v_u D) + V_c](027-16)$
- E. Analysis of vertical elements of the lateral force-resisting system. Applicable to both general procedure and special procedure buildings.
1. Existing URM walls.
 - a. Flexural rigidity. Flexural components of deflection may be neglected in determining the rigidity of a URM wall.
 - b. Shear walls with openings. Wall piers shall be analyzed according to the following procedure:
 - i. For any pier,

- aa. The pier shear capacity shall be calculated as:
 $V_a = v_a D t$ (027-17)
- bb. The pier rocking shear capacity shall be calculated as:
 $V_r = 0.5 P_D D / H$ (027-18)
- ii. The wall piers at any level are acceptable if they comply with one of the following modes of behavior:
- aa. Rocking controlled mode. When the pier rocking shear capacity is less than the pier shear capacity, i.e. $V_r < V_a$ for each pier in a level, forces in the wall at that level, V_{wx} , shall be distributed to each pier, V_p , in proportion to $P_D D / H$.
- For the wall at that level: $V_{wx} < V_r$ (027-19)
- bb. Shear controlled mode. Where the pier shear capacity is less than the pier rocking capacity, i.e. $V_a < V_r$ in at least one pier in a level, forces in the wall at that level, V_{wx} , shall be distributed to each pier, V_p , in proportion to D / H .
- For each pier at that level:
 $V_p < V_a$ (027-20) and
 $V_p < V_r$ (027-21)
 If $V_p > V_a$ for each pier and $V_p > V_r$ for one or more piers, omit such piers from the analysis and repeat the procedure for the remaining piers, or strengthen and reanalyze the wall.
- iii. Masonry pier tension stress. Unreinforced masonry wall piers need not be analyzed for tension stress.
- c. Shear walls without openings. Shear walls without openings shall be analyzed as for walls with openings except that V_r shall be calculated as follows:
 $V_r = (0.50 P_D + 0.25 P_W) D / H$ (027-22)
2. Plywood sheathed shear walls. Plywood sheathed shear walls may be used to resist lateral loads for buildings with flexible diaphragms analyzed according to provisions of Subsection 18.68.027.C. Plywood sheathed shear walls may not be used to share lateral loads with other materials along the same line of resistance.
3. Combinations of vertical elements.
- a. Lateral force distribution. Lateral forces shall be distributed among the vertical resisting elements in proportion to their relative rigidities, except that moment frames shall comply with Subsection 18.68.027.E.3.b.
- b. Moment resisting frames. A moment frame shall not be used with a URM wall in a single line of resistance unless the wall has piers that are capable of sustaining rocking in accordance with Subsection 18.68.027.E.1.b and the frames are designed to carry one hundred percent (100%) of the lateral forces and the interstory drift ratio shall be limited to 0.0025.

18.68.028 – Detailed system design requirements.

A. Wall anchorage.

1. Anchor locations. All unreinforced masonry walls shall be anchored at the roof and floor levels as required in Subsection 18.68.027.C.4. Ceilings with substantial rigidity and abutting masonry walls shall be connected to walls with tension bolts at a maximum anchor spacing of

- six (6) feet. Ceiling systems with substantial mass shall be braced at the perimeter to the roof or floor diaphragms.
2. Anchor requirements. Anchors shall be tension bolts through the wall as specified in Table No. A-23-D, or by an approved equivalent at a maximum anchor spacing of six (6) feet. All existing wall anchors shall be secured to the joists to develop the required forces.
 3. Minimum wall anchorage. Anchorage of masonry walls to each floor or roof shall resist a minimum force determined by UBC Section 2312 (g) 2 or two hundred (200) pounds per linear foot, whichever is greater, acting normal to the wall at the level of the floor or roof. Existing wall anchors, installed under previous permits, must meet or must be upgraded to meet the requirements of this chapter.
 4. Anchors at corners. At the roof and all floor levels, both shear and tension anchors shall be provided within two (2) feet horizontally from the inside of the corners of the walls.
 5. Anchors with limited access. When access to the exterior face of the masonry wall is prevented by proximity of an existing building, wall anchors conforming to Item 6b in Table A-23-D may be used.
- B. Diaphragm shear transfer. Shear bolt spacing shall have a maximum bolt spacing of six (6) feet.
- C. Collectors. Collector elements shall be provided which are capable of transferring the seismic forces originating in other portions of the building to the element providing the resistance to those forces.
- D. Ties and continuity. Ties and continuity shall conform to UBC Section 2312(h)2E.
- E. Wall bracing.
1. General. Where a wall height-thickness ratio exceeds the specified limits, the wall may be laterally supported by vertical bracing members per Subsection 18.68.028.E.2 or by reducing the wall height by bracing per Subsection 18.68.028.E.3.
 2. Vertical bracing members. Vertical bracing members shall be attached to floor and roof construction for their design loads independently of required wall anchors. Horizontal spacing of vertical bracing members shall not exceed one-half (1/2) the unsupported height of the wall nor ten (10) feet. Deflection of such bracing members at design loads shall not exceed one-tenth (1/10) of the wall thickness.
 3. Intermediate wall bracing. The wall height may be reduced by bracing elements connected to the floor or roof. Horizontal spacing of the bracing elements and wall anchors shall be as required by design but shall not exceed six (6) feet on center. Bracing elements shall be detailed to minimize the horizontal displacement of the wall by the vertical displacement of the floor or roof.
- F. Parapets. Parapets and exterior wall appendages not conforming to this chapter shall be removed, or stabilized or braced to ensure that the parapets and appendages remain in their original position.

The maximum height of an unbraced unreinforced masonry parapet above the lower of either the level of tension anchors or roof sheathing, shall not exceed one and one-half (1½) times the thickness of the parapet wall. If the required parapet height exceeds this maximum height, a bracing system designed for the force factors specified in UBC Table 23-P for walls shall support the top of the parapet. Parapet corrective work must be performed in conjunction with the installation of tension roof anchors.

The minimum height of a parapet above the wall anchor shall be twelve (12) inches.

EXCEPTION: If a reinforced concrete beam is provided at the top of the wall, the minimum height above the wall anchor may be six (6) inches.

G. Veneer.

1. Unreinforced masonry walls which carry no design loads other than their own weight may be considered as veneer if they are adequately anchored to new supporting elements.
2. Veneer shall be anchored with approved anchor ties, conforming to the required design capacity specified in this title and placed at a maximum spacing of twenty-four (24) inches with a maximum supported area of two (2) square feet.

EXCEPTION: Existing veneer anchor ties may be acceptable provided the ties are in good condition and conform to the following minimum size, maximum spacing and material requirements.

Existing veneer anchor ties shall be corrugated galvanized iron strips not less than one (1) inch in width, eight (8) inches in length and one-sixteenth (1/16) of an inch in thickness or equal and shall be located and laid in every alternate course in the vertical height of the wall at a spacing not to exceed seventeen (17) inches on centers horizontally. As an alternate, such ties may be laid in every fourth course vertically at a spacing not to exceed nine (9) inches on centers horizontally.

3. The location and condition of existing veneer anchor ties shall be verified as follows:
 - a. An approved testing laboratory shall verify the location and spacing of the ties and shall submit a report to the Building Official for approval as a part of the structural analysis.
 - b. The veneer in a selected area shall be removed to expose a representative sample of ties (not less than four) for inspection by the Building Official.

H. Truss and beam supports. Where trusses and beams other than rafters or joists are supported on masonry, independent secondary columns shall be installed to support vertical loads of the roof or floor members. The loads shall be transmitted down to adequate support.

I. Adjacent buildings.

1. Where elements of adjacent buildings do not have a separation of at least five (5) inches, the allowable height/thickness ratios for "buildings with crosswalls" per Table A-23-B shall not be used in the direction of consideration.
2. Where an exterior URM bearing wall does not have a separation of at least five (5) inches and the diaphragm levels of the adjoining structures differ by more than one and one-half (1½) times the wall thickness, supplemental vertical gravity load carrying members shall be added to support the loads normally carried by the wall and such members shall not be attached to the wall. The loads shall be transmitted down to the foundation.

J. Infill frames.

1. General. In addition to other applicable requirements of this chapter, concrete and steel frames shall comply with the special provisions of this section.
2. Infill walls. All infill walls shall be located and dimensioned on the plans and an appropriate repair defined for any observed areas of distress in the frames or infill walls including spalling, cracking or corrosion. Out of plane forces acting on the infill shall be considered unless it is

- shown that the infill is tightly grouted to the frame and the h/t ratio between supports is less than sixteen (16).
3. Buildings with reinforced infill can be designed as shear wall building using the force provisions of the Table A-23-E provided that it is shown by conventional rigidity analyses that the building as retrofitted meets the regularity requirements of the 1988 UBC.
 4. Buildings with reinforced infill can be designed as shear wall building using the force provisions of the Table A-23-E provided that it is shown by conventional rigidity analyses that the building as retrofitted meets the regularity requirements of the 1988 UBC.
 5. Buildings with reinforced infill can be designed as shear wall building using the force provisions of the Table A-23-E provided that it is shown by conventional rigidity analyses that the building as retrofitted meets the regularity requirements of the 1988 UBC.
 6. Wythes of infill walls that occur beyond the confining edges of frame columns and beams shall be anchored as veneer to the frame or the confined portion of the infill wall.

18.68.030 – Prima facie hazard grating.

- A. All structures covered by this chapter and constructed before January 9, 1934, shall be inspected and graded in accordance with the provisions set forth in this chapter, such inspection to determine the relative prima facie earthquake hazard associated with same, and graded to establish a priority for subsequent correction. Such buildings which are three stories or less in height shall be inspected and graded by the Building Official and all others shall be inspected and graded in accordance with Section 18.68.050. Grading shall consist of an evaluation based upon an examination of the building plans, specifications or reports that are available, a visual inspection and consideration of the occupancy classification and occupant load. The evaluation shall include an analytical evaluation which shall determine the resistance to earthquake forces of the primary structural system of the structure. The analysis shall be based insofar as possible on the same procedures and assumptions used in seismic design of new buildings, and for purposes of evaluation, shall consist of a comparison of the seismic resistance of the existing building to the seismic resistance required of a new building designed and constructed under the building regulations of the 1970 Uniform Building Code, and otherwise identical to the existing building insofar as location, use, configuration, structural system and materials of construction are concerned. Such comparison can be expressed in terms of a capacity ratio R_S defined as follows:
$$R_S = V_{REQ}/V_{CAP}$$

Where V_{CAP} is the lateral force resistive capacity of a particular existing structure, calculated for the critical mode of failure of a significant portion of the building and V_{REQ} is the required lateral force resistive capacity of the same structure calculated for those specified earthquake conditions set forth in the building regulations of the 1970 Uniform Building Code. For the purposes of assessing the lateral force capacity of existing construction, certain stresses, values and procedures will be established as acceptable, such values to be set forth in a specification entitled "Specifications for Assessing the Capacity of Unreinforced Masonry Buildings, Long Beach Department of Development Services," to be prepared by the Building and Safety Bureau, which specifications may be amended from time to time at the discretion of the Department. Assessment of the capacity ratio R_S shall take into account the following elements:

1. Stability of the wall system and vertical framing;
2. Horizontal diaphragm and/or bracing system;
3. Connections;
4. Shear resisting elements;

5. Special hazards, either structural or nonstructural.
- B. In the assignment of a building to a particular hazard grade, the Building Official shall first determine its location on a hazardous index which shall reflect relative degrees of hazard. Such hazardous index shall be established in the specifications entitled "Specifications for Assessing the Capacity of Unreinforced Masonry Buildings, Long Beach Department of Development Services," and shall be a function of the capacity ratio R_S as defined in this section, the occupancy classification of the building and an occupancy potential which is a measure of the human exposure in and near the building. Occupancy classification and occupancy potential shall be as set forth in the above-mentioned specifications.
- C. Location of a building on the Hazardous Index shall be the determining factor in the assignment of a building to a particular hazard grade. Assignment shall be by the Building Official and shall be in one of the following three hazardous grades if the capacity of the building has been determined to be less than that required under the building regulations of the 1970 Uniform Building Code:
- Excessive Hazard Grade I
 - High Hazard Grade II
 - Intermediate Hazard Grade III
- D. Limits on the Hazardous Index which will determine placement in particular hazard grades shall be as established in the above-mentioned specifications and shall in general limit Excessive Hazard - Grade 1 to approximately ten percent (10%) of the buildings occupying the highest hazards on the Hazardous Index; the High Hazard - Grade II to approximately thirty percent (30%) of the buildings occupying the middle portion of the Hazardous Index; and the Intermediate Hazard - Grade III to approximately sixty percent (60%) of the buildings occupying the lowest hazards on the Hazardous Index.
- E. If an assessment results in a capacity virtually equal to that required under the building regulations of the 1970 Uniform Building Code, or if a repair is accomplished to affect conformance with the seismic requirements of the building regulations of the 1970 Uniform Building Code, the building shall be deemed as having no hazards and shall be so classified.

18.68.040 – Special and intermediate hazards.

In addition to evaluation of the primary structural systems, any structural or nonstructural element of the building, including parapets, ornamentation or other appendages attached to the building or any structural or nonstructural architectural, mechanical or electrical system that is determined by reason of lack of attachment, anchorage or condition, to become dangerous to persons in the building or in the vicinity, will be classed as an immediate hazard. Any immediate hazard identified in buildings classified as high or intermediate hazard shall be treated as an excessive hazard and shall be abated under the procedures established for excessive hazard.

18.68.050 – Priority and method of grading.

- A. Buildings shall in general be graded on a priority system but in three (3) phases: Phase I shall consist of inspection and grading of all buildings less than four (4) stories in height and within occupancy classifications A, B, C, D and E; Phase II will consist of inspection and grading of all buildings two (2) and three (3) stories in height and classified F, G and H; and Phase III will consist of inspection and grading of all buildings remaining to be graded. Grading of all structures in each phase shall be accomplished insofar as is possible by a date established by the Department, and on that date, owners and interested parties will be promptly notified of the hazard grade in which their building has been placed. Such notification shall give notice to the owner of the hazard grade in which the building is being placed, a procedure to be followed if the owner is in disagreement with the grading, and that the grade assigned will be recorded with the

county recorder after sixty (60) days unless a change in grade has been initiated as set forth in Section 18.68.190.

- B. Buildings four (4) stories or more in height shall be placed in the appropriate hazard grade by the Building Official after receipt from the building owner of such information and data as is necessary to adequately grade the building. Such information and data shall be gathered for the owner at his expense by a structural or civil engineer or an architect licensed under the laws of the State and shall be submitted to the Building Official by such dates as he will set consistent with those occupancy classifications established for other buildings as set forth in this section for Phases I, II and III. Notice to require gathering of such information by the owner shall be substantially in the form set forth in Section 18.68.180. The Building Official shall, after reviewing the information and data submitted, place the building in the appropriate hazard grade and shall promptly notify the owner of the hazard grade in which his building has been placed. Failure to provide the Building Official with the required information and data by such established dates will result in placement of the building in Excessive Hazard - Grade I, until such information is submitted and the building is graded in accordance with the provisions of this chapter.

18.68.060 – Calculation of of actual lateral force capacity V_{CAP} .

The actual lateral force capacity, V_{CAP} , of a particular structure shall be computed using those values and stresses set forth in specifications entitled "Specifications for Assessing Capacity of Unreinforced Masonry Buildings, Long Beach Department of Building and Safety."

18.68.070 – Hazardous grading and dates of corrective action.

- A. Owners of structures that have been graded Excessive Hazard - Grade I will be given notice of the need for corrective action as soon as such grading has been accomplished. Such notification shall take the form of notice of corrective action as set forth in Section 18.68.090.
- B. Owners of structures that have been graded High Hazard - Grade II will be notified of the need for corrective action on January 1, 1984, or as soon thereafter as Departmental office procedures will permit. Such notification shall take the form of notice of corrective action as set forth in Section 18.68.090.
- C. Owners of structures that have been graded Intermediate Hazard - Grade III will be notified of the need for corrective action on January 1, 1991, or as soon thereafter as Departmental office procedures will permit. Such notification shall take the form of Notice of Corrective Action as set forth in Section 18.68.090.

18.68.080 – Hazardous grading subject to change.

- A. Buildings placed in a particular hazardous grade may be changed to a lesser grade if corrective repairs are undertaken and accomplished. Hazardous grading may also be changed when competent engineering data is submitted substantiating such a change. Such data may consist of analytical assessments, tests, data substantiating a higher capacity ratio or a modification of use or occupancy potential. Corrective repair plans and/or data substantiating a change in hazardous grading shall be prepared by a structural or civil engineer or architect licensed under the laws of the State to practice said profession. Partial repair designed to correct or strengthen individual and/or critical elements of a building will be permitted provided a suitable plan indicating the method of total and eventual correction and the schedule of expected dates of correction is submitted and the method of eventual correction is approved. Buildings so repaired will be regarded reflecting repairs so accomplished.
- B. Complete repair and removal from any hazardous classification will be deemed to have been accomplished when the building has been repaired in accordance with this chapter or with the provisions for repair to remove structures from hazardous classifications in the "Specifications for

Assessing the Capacity of Unreinforced Masonry Buildings, Long Beach Department of Building and Safety."

18.68.090 – Notice of corrective action.

After completion of grading, the Building Official shall send to owners of buildings deemed to be Excessive Hazard - Grade I, a notice of corrective action via certified United States mail. Owners of structures that have been graded High Hazard - Grade II and Intermediate Hazard - Grade III, will be sent such a notice at such time as specified in Section 18.68.070. This notice shall be in substantially the following form:

NOTICE OF CORRECTIVE ACTION

PLEASE TAKE NOTICE that an inspection and evaluation of your structure located at:

Indicates that said structure carries an (excessive, high, intermediate) hazard of major damage in the event of earthquake which would endanger the safety of persons and property located in, on or about said structure at the time of such event. Within sixty (60) days from the date of this notice you shall present to this office a plan of action for reducing the earthquake hazard associated with said structure to an acceptable level.

An extension of the aforesaid sixty (60) day period may be obtained, for good cause shown, by requesting same in writing filed with this office at least seven (7) calendar days prior to the expiration of said sixty (60) day period. Such request shall be accompanied by a written statement of your contemplated action, the accomplishments toward same up to the time of the request, an estimate of the time required to complete the formulation of your proposed plan of action, and the name and address of the engineer, or architect, if any, whom you may have engaged.

In the event your proposed plan of action contemplates repair or some action other than abandonment and demolition, within one hundred twenty (120) calendar days, you shall submit to this office proposed repairs or strengthening measures which will increase the lateral force withstanding capability of the structure to a level commensurate with the acceptable level of earthquake hazard for your prospective use or occupancy. Information as to the magnitude of the lateral force withstanding capability associated with your structure in its present condition, as well as information as to proposed repairs or strengthening measures intended to increase the lateral force withstanding capability, shall be prepared by a structural or civil engineer or architect licensed under the laws of the State of California to practice said profession.

An extension of the aforesaid one hundred twenty (120) days may be granted for good cause shown by requesting same in writing filed with this office at least seven (7) calendar days prior to the expiration of the said one hundred twenty (120) day period. Such request shall be accompanied by a written statement explaining the reason for such an extension and an estimate of the date on which plans will be completed, the degree to which plans have already been completed, and other information which will document the fact that work is progressing.

In the event abandonment and demolition is contemplated, a date certain for such abandonment and demolition shall be submitted to the Building Official for evaluation and approval.

A copy of the ordinance, by authority of which this notice is sent, may be obtained from the office of the City Clerk, upon payment of an appropriate fee.

18.68.100 – Application for order of abatement of nuisance.

- A. In the event the owner of a structure is notified pursuant to Section 18.68.090 and a plan of action satisfactory to the Building Official is not presented within sixty (60) days after the notice

has been mailed or within such extension of time as may have been granted in writing by the Building Official; or if the proposed plan of action, contemplated repair, or some action other than abandonment and demolition, has not been submitted and agreed upon by the Building Official within the one hundred twenty (120) days provided in Section 18.68.090 or within such extension of time as the Building Official may have granted; then the Building Official shall apply in writing to the Board of Examiners, Appeals and Condemnation for an order declaring the structure to be a nuisance and ordering the Certificate of Occupancy to be revoked, or that it be demolished or repaired in a manner satisfactory to the Building Official, all by a date certain. The written application shall set forth in the form of factual allegations all facts which, if proven, are necessary to justify an order of condemnation, including, but not limited to the following:

1. The location and legal description of the structure;
 2. A concise calculation sheet indicating the ratio R_s for each of the elements of the structural system;
 3. The structure's present occupancy;
 4. The date upon which the owner of the structure was notified pursuant to Section 18.68.090;
 5. A statement as to whether the structure owner has submitted a plan of action pursuant to Section 18.68.090;
 6. The date certain by which the structure must be repaired or demolished, in the Building Official's opinion, in order to keep the earthquake hazard associated with it at or below the applicable tolerable level.
- B. A copy of the written application shall be mailed by certified United States mail to the person to whom the notice of Section 18.68.090 was mailed.

18.68.110 – Hearing by Board.

In the event the Building Official files an application pursuant to Section 18.68.100, he shall set a date and time for a hearing before the Board of Examiners, Appeals and Condemnation in accordance with Section 18.20.130.

18.68.120 – Appeals to City Council.

Whenever the owner of any structure is aggrieved by any final order of the Board of Examiners, Appeals and Condemnation, dealing with the abatement of a nuisance as provided in this chapter, such owner may within five (5) days of notice of such ruling or act appeal to the City Council as provided in Section 18.20.140.

18.68.130 – Owner responsibility to demolish structure.

In the event the Board of Examiners, Appeals and Condemnation orders a structure demolished, immediately upon the effective date of its order, the structure's owner shall arrange for the vacation and demolition of the structure within sixty (60) days after the Board's order becomes effective, unless such order is modified or reversed by the City Council or is stayed by a court of competent jurisdiction. Should the structure owner fail to inform the Building Official within five (5) days after the Board's order becomes effective that such arrangements have been made or should the owner's scheduled demolition not in fact be completed within the aforesaid sixty (60) day period, then the Building Official may arrange for the demolition of the subject structure and impose a lien upon the property for the costs of same.

18.68.135 – Landmark structures – Alternatives to demolition.

Upon receipt of an application for a permit to demolish a landmark building to comply with the provisions of this chapter, the Building Official shall request the City Clerk to present such application before the City Council at their next scheduled meeting. City Council shall thereupon set a public hearing not less than ten (10) nor more than thirty (30) days from the date the application is presented. On the date thus fixed, or on the date to which the hearing has been subsequently continued, City Council shall proceed to hear testimony and receive evidence relating to the matter. At the conclusion of the hearing, City Council shall make a determination on the method of abating the earthquake hazardous conditions of the building based upon the estimated comparative costs of seismic rehabilitation and demolition, any financial assistance programs that may be available to the owner for rehabilitation, the potential life safety risks involved, or any other pertinent information. Following the hearing, the City Council may order demolition. Alternatively, the City Council may consider (1) ordering the building vacated and secured against unlawful entry, (2) barricading the pedestrian areas surrounding the building subject to hazards from parts of the building dislodged in an earthquake, and/or (3) allowing additional time to strengthen the building. In the event authorization is not granted for a permit to demolish and/or an alternative is ordered, all demolition permit processing fees submitted by the applicant shall be refunded and the applicant shall be deemed relieved of any further responsibility to demolish the structure under this chapter except as may be provided in the alternate permit issued.

18.68.140 – Notice of pending order of demolition.

- A. In the event the Board orders the demolition of the subject structure by a date certain which is three (3) months or more after the effective date of the order, and the order is not modified or reversed by the City Council or is not stayed by a court of competent jurisdiction, the Building Official shall prepare a notice of pending order of demolition and arrange for the recordation of same in the office of the county recorder of Los Angeles County. The notice shall be in substantially the following form:

NOTICE OF PENDING
ORDER OF DEMOLITION

TO WHOM IT MAY CONCERN:

NOTICE IS HEREBY GIVEN that by order of the Board of Examiners, Appeals and Condemnation of the City of Long Beach, State of California, dated _____, 19_____, that certain structure now standing at _____ and described generally as _____ must and shall be demolished on or before _____ 19_____.

A certified copy of said order may be obtained from the office of the Department of Development Services, Building and Safety Bureau, of the City of Long Beach upon the payment of the appropriate fee. If said structure is not demolished in accordance with the aforesaid order, the same may be demolished by the City of Long Beach and the costs therefore assessed as a lien upon the land upon which the structure stood. A lien in the amount of \$_____ in favor of the City of Long Beach is hereby assessed against said property for the costs of recording this notice.

- B. The notice shall be recorded under the names of each and every person to whom the notice of Section 18.68.090 was mailed. The structure's owner may pay the recording fees for the aforesaid notice and thereby avoid the imposition of lien for same against the property.

18.68.150 – Owner responsibility to accomplish hazard reduction measures.

In the event the Board or the City Council certifies to the validity of any or all of any measures the owner has proposed as a means of reducing the earthquake hazard, and finds that the accomplishment of such measures will reduce the earthquake hazard associated with the structure

to or below the applicable tolerable level, it shall order the owner to immediately initiate the accomplishment of such measures and to complete the same within a reasonable time. The Board or the City Council shall designate in its order, based on evidence presented to it during the hearing, that date certain which represents a reasonable time in its opinion for the accomplishment of the proposed measures.

18.68.160 – Jurisdiction of Board or Council over certain cases.

The Board or the City Council shall retain jurisdiction over cases in which it has approved owner-proposed measures for reducing earthquake hazard until such measures have been timely accomplished. In the event written evidence of the completion of the approved measures is not presented to the Board or the City Council within ten (10) days after the designated date for the completion of such measures shall have passed, the Board or the City Council may revise its decision and order the immediate vacation and demolition of the structure. The Board or City Council may consider a time extension for the completion of the proposed measures if, prior to said date, the structure's owner has so applied. Any application for such an extension shall be in writing, setting forth what has actually been accomplished, what remains to be done, and the reasons for the requested extension. Should the Board or the City Council conclude that good cause has been shown for an extension, it may grant such an extension in writing for a period deemed necessary to complete the approved repairs.

18.68.170 – Hearing—Failure of owner to proceed in good faith.

In the event the Building Official or any interested person presents written affidavits to the Board or the City Council indicating the owner is not proceeding in good faith to timely accomplish any measures approved by the Board or the City Council in its original decision and order, the Board or City Council shall, on ten (10) days' written notice mailed via certified United States mail to the owner of the structure, schedule and conduct a hearing on the matter. At such hearing, evidence, oral and written, may be presented as in the original hearing, and if the Board or the City Council is convinced that the owner is not proceeding in good faith to timely carry out its original order, then it shall revoke the order and order instead the immediate vacation and demolition of the structure. Written affidavits shall not, however, be received by the Board or the City Council under this section until at least fifty percent (50%) of the time allowed in its original order has expired.

18.68.180 – Notification to owners of buildings four stories or more in height.

Pursuant to Section 18.68.050, notification shall be sent via certified United States mail to owners of buildings four (4) stories or more in height, on such dates as are determined in Section 18.68.050. Such notification shall require the owner to have gathered and submitted to the Building Official information and data relating to the building's capabilities to withstand earthquake forces in sufficient detail to permit grading of the building in accordance with Section 18.68.030. Such information and data shall be gathered by a structural or civil engineer or architect licensed under the laws of the State. The notification shall state the date by which the information and data shall be transmitted to the Building Official, and that failure to so transmit shall result in arbitrarily placing the building in the Excessive Hazard – Grade I category.

18.68.190 – Notice of county recorder.

Upon expiration of the sixty (60) day period after notification to owners and interested parties of the hazardous grade in which their building is being placed, all in accordance with Section 18.68.050, and if such hazardous grading has not been changed or required data substantiating a change has not been submitted as set forth in Section 18.68.080, the Building Official shall prepare and cause to be recorded with the county recorder a certificate stating that the building has been graded and assigned the particular hazardous grade determined under Section 18.68.030. When and if all required repairs are made to the building and it is removed from the hazardous grading, or certain corrective action is taken to change it to a different grade, the Building Official shall cause to be

recorded with the county recorder records indicating the removal from said hazardous grading or reflecting the change to the different grade.

18.68.200 – Figure No. A-23-1.

Acceptable diaphragm span is shown in Figure A-23-1.

18.68.210 – Tables A-23-A through A-23-F.

Force factors and material values are shown in Tables A-23-A through A-23-F.

18.68.220 – Standard No. 24-40, in-place masonry shear tests.

The bed joints of the outer wythe of the masonry shall be tested in shear by laterally displacing a single brick relative to the adjacent bricks in the same wythe. The head joint opposite the loaded end of the test brick shall be carefully excavated and cleared. The brick adjacent to the loaded end of the test brick shall be carefully removed by sawing or drilling and excavating to provide space for a hydraulic ram and steel loading blocks. Steel blocks, the size of the end of the brick, shall be used on each end of the ram to distribute the load to the brick. The blocks shall not contact the mortar joints. The load shall be applied horizontally, in the plane of the wythe, until either a crack can be seen or slip occurs. The strength of the mortar shall be calculated by dividing the load at the first crack or movement of the test brick by the nominal gross area of the sum of the two (2) bed joints.

18.68.221 – Standard 24-41, tests of anchors in unreinforced masonry walls.

- A. Existing Anchors. The test apparatus shall be supported on the masonry wall at a minimum distance of the wall thickness from the anchor tested. Existing wall anchors shall be given a preload of three hundred (300) pounds prior to establishing a datum for recording elongation. The tension test load reported shall be recorded at one-eighth (1/8) inch relative movement of the anchor and the adjacent masonry surface. Results of all tests shall be reported. The report shall include the test results as related to the wall thickness and joist orientation.

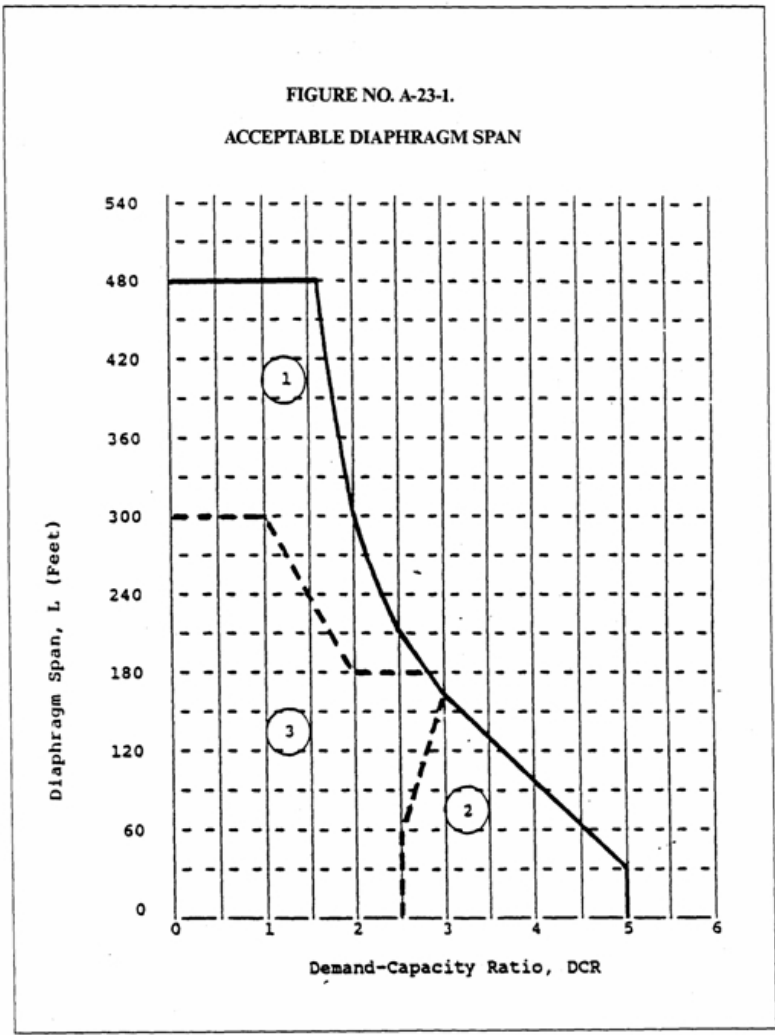

TABLE NO. A-23-A
HORIZONTAL FORCE FACTOR C_p

CONFIGURATION OF MATERIALS	C_p
Roofs with straight or diagonal sheathing and roofing applied directly to the sheathing, or floors with straight tongue and groove sheathing.	0.5
Diagrams with double or multiple layers of Boards with edges offset and blocked plywood systems.	0.74

TABLE NO. A-23-B
ALLOWABLE VALUE OF HEIGHT-THICKNESS RATIO OF
UNREINFORCED MASONRY WALLS

Wall Types	Buildings with Crosswalls ¹	All Other Buildings
Walls of one-story buildings	16 ^{2,3}	13
First-story wall of multi-story building	16	15
Walls in top story of multi-story buildings	14 ^{2,3}	9
All other walls	16	13

¹ Applies to the Special Procedures of Subsection 18.68.027.D only. See Subsection 18.68.027.D.7 for other restrictions.

² This value of height-to-thickness ratio may be used only where mortar shear tests in accordance with Section 18.68.024 establish a tested mortar shear strength, v_t , of not less than one hundred (100) psi or where the tested mortar shear strength, v_t , is not less than sixty (60) psi and a visual examination of the collar joint indicates not less than fifty percent (50%) mortar coverage.

³ Where a visual examination of the collar joint indicates not less than fifty percent (50%) mortar coverage and the tested mortar shear strength, v_t , when established in accordance with Section 18.68.024 is greater than thirty (30) psi but less than sixty (60) psi, the allowable height-to-thickness ratio may be determined by linear interpolation between the larger and smaller ratios in direct proportion to the tested mortar shear strength, v_t .

TABLE NO. A-23-C
ALLOWABLE VALUES FOR EXISTING MATERIALS

EXISTING MATERIALS OR CONFIGURATIONS OF MATERIALS ¹		ALLOWABLE VALUES
1.	HORIZONTAL DIAPHRAMS ⁴	
a.	Roofs with straight sheathing and roofing applied directly to the sheathing.	100 lbs. per foot for seismic shear
b.	Roofs with diagonal sheathing and roofing applied directly to the sheathing.	250 lbs. per foot for seismic shear
c.	Floors with straight tongue-and-groove sheathing.	100 lbs. per foot for seismic shear
d.	Floors with straight sheathing and finished wood flooring with Board edges offset or perpendicular	500 lbs. per foot for seismic shear
e.	Floors with diagonal sheathing and finished wood flooring.	600 lbs. per foot for seismic shear
2.	CROSSWALLS ^{2,4}	
a.	Plaster on wood or metal lath	Per side: 200 lbs. per foot for seismic shear
b.	Plaster on gypsum lath	175 lbs. per foot for seismic shear
c.	Gypsum wall Board, unblocked edges	75 lbs. per foot for seismic shear
d.	Gypsum wall Board, blocked edges	125 lbs. per foot for seismic shear
3.	EXISTING FOOTINGS, WOOD FRAMING, STRUCTURAL STEEL, AND REINFORCED CONCRETE	
a.	Plain concrete footings	$F'_c = 1500$ psi unless otherwise shown by tests ³
b.	Douglas fir wood	Allowable stress same as No. 1 D.F. ³
c.	Reinforcing steel	$f_t = 18,000$ lbs. per square inch

		maximum. ³
d.	Structural steel	$f_t = 20,000$ lbs. per square inch maximum. ³

¹ Bolts to be tested as specified in Section 18.68.025.

² Bolts to be (-inch minimum in diameter.

³ Drilling for bolts and dowels shall be done with an electric rotary drill. Impact tools shall not be used for drilling holes or tightening anchors and shear bolt nuts.

⁴ A one-third increase in allowable stress is not allowed.

⁵ Stresses given may be increased for combinations of loads as specified in the Uniform Building Code.

TABLE A-23-E
 β Factors

SYSTEM	β
A. URM Bearing Wall Building	1.0
B. Ordinary Steel Moment Frame	
1. Without infill (after removal of infill)	.065 ⁽¹⁾
2. Clay tile infill	(3)
3. Unreinforced masonry or concrete infill	0.65 ⁽²⁾
4. Reinforced masonry or concrete infill	0.80 ⁽²⁾
C. Ordinary Concrete Moment Frame	
1. Without infill (after removal of infill)	0.65 ⁽¹⁾
2. Clay tile infill	(3)
3. Unreinforced masonry or concrete infill	0.65 ⁽²⁾
4. Reinforced masonry or concrete infill	0.80 ⁽²⁾

Notes:

Editor's note—

The shear capacity of frame columns adjacent to (1) infill walls shall be capable of resisting story shears using $\phi = 1.0$.

Editor's note—

Where partial infills are used to resist the story (2) shear, the shear capacity of frame columns adjacent to partial infill walls shall be capable of resisting story shears using $\phi = 1.0$.

Editor's note—

Clay tile infill may not be considered for resisting (3) building lateral forces. Hence, if the infill is clay tile, either it needs to be removed and replaced with reinforced concrete or masonry (and a ϕ of 0.80 utilized) or the infill can remain in place (provided it is protected from becoming a falling hazard) and the frame is qualified with a ϕ of 0.65.

TABLE A-23-F
 ϕ OCCUPANCY LOAD FACTOR

OCCUPANT LOAD*	ϕ
100 or more	1.25
Less than 100	1.0

Editor's note—

The Occupant Load shall be defined as specified in the * 1985 UBC Section 3302(a)

- B. Combined shear and tension bolts. Combined shear and tension bolts embedded in unreinforced masonry walls shall be tested using a torque calibrated wrench to the following minimum torques:

½-inch-diameter bolts — 40 foot lbs.

⅝-inch-diameter bolts — 50 foot lbs.

¾-inch-diameter bolts — 60 foot lbs.

All nuts shall be installed over malleable iron or plate washers when bearing on wood and heavy cut washers when bearing on steel.

18.68.222 – Standard 24-42, pointing of unreinforced masonry walls.

The old or deteriorated mortar should be cut out, by means of a toothing chisel or nonimpact power tool to a uniform depth of three-fourths-inch, or until sound mortar is reached. Care must be taken not to damage the brick edges. After cutting is completed, remove all loose material with a brush, air, or water stream.

Mortar mix shall be type "N" or "S" proportions as called for in the construction specifications, preferably as close to the original mortar proportion as possible. Prehydrate pointing mortar to reduce excessive shrinkage. To prehydrate mortar, thoroughly mix all ingredients dry, then mix again, adding only enough water to produce a damp unworkable mix which will retain its form when pressed into a ball. After keeping mortar in this dampened condition for one (1) to one and one-half (1½) hours, add sufficient water to bring it to the proper consistency that is somewhat drier than conventional masonry mortar. To ensure good bond, wet the mortar joints thoroughly before applying pointing mortar. The joints should not be visibly wet with free-standing water which must be absorbed into the wall. Pack mortar tightly in thin layers (one-fourth inch maximum) until the joint is filled, then tool to a smooth surface to match original profile.

CHAPTER 18.69 VOLUNTARY EARTHQUAKE HAZARD REDUCTION IN EXISTING WOOD FRAME RESIDENTIAL BUILDINGS WITH WEAK CRIPPLE WALLS AND UNBOLTED SILL PLATES

- 18.69.010 – General.
- 18.69.020 – Definitions.
- 18.69.030 – Structural weaknesses.
- 18.69.040 – Strengthening requirements.
- 18.69.050 – Quality control.

CHAPTER 18.69

VOLUNTARY EARTHQUAKE HAZARD REDUCTION IN EXISTING WOOD FRAME RESIDENTIAL BUILDINGS WITH WEAK CRIPPLE WALLS AND UNBOLTED SILL PLATES

18.69.010 – General.

- A. Purpose. The provisions of this chapter are intended to promote public safety and welfare by reducing the risk of earthquake-induced damage to existing wood-framed residential buildings. The voluntary minimum standards contained in this chapter shall substantially improve the seismic performance of these residential buildings but will not necessarily prevent all earthquake damage. When fully followed, these standards will strengthen the portion of the structure that is most vulnerable to earthquake damage.

Prior to 1960, most wood frame residential buildings were built with raised wood floors supported by short wood stud walls known as cripple walls. These cripple walls are typically braced with weak seismic materials such as portland cement plaster or horizontal wood siding. In addition, wood frame buildings built under Building Codes in effect prior to July 1938 were not required to be bolted to their foundations. Recent earthquakes have shown that if a building has weak cripple walls or is unbolted, it may fall off its foundation even in moderate earthquakes.

Fallen buildings have collapsed, caught fire or needed extensive repairs to restore their occupancy.

This chapter sets prescriptive standards for strengthening of under floor enclosures, if permitted by the Building Official, without requiring construction documents prepared by a registered design professional licensed by the State of California. This chapter also provides a design standard for the use of alternate materials or an alternate method of construction in lieu of the prescriptive standards.

Construction documents for strengthening using alternate materials or methods shall be prepared by a registered design professional licensed by the State of California.

- B. Scope. The provisions of this chapter may be applied to light wood frame Group R occupancies, with no more than four (4) dwelling units when they contain one (1) or more of the structural weaknesses specified in Section 18.69.030.

The provisions of this chapter do not apply to the buildings or elements thereof listed below. These buildings or elements require analysis by a registered design professional licensed by the State of California in accordance with Chapter 16 of the California Building Code adopted in Chapter 18.40 or other approved standards to determine appropriate strengthening.

1. Buildings with a lateral-force-resisting system using poles or columns embedded in the ground.
2. Cripple walls that exceed four (4) feet in height.
3. Buildings exceeding three (3) stories in height and any three (3) story building with cripple wall studs exceeding fourteen (14) inches in height.
4. Buildings, or portions thereof, constructed on a concrete slab on grade or constructed on or into a slope steeper than one (1) unit vertical in three (3) units horizontal (33.3% slope).
5. Buildings where the Building Official determines that conditions exist that are beyond the scope of the requirements of this chapter.

The standard details approved by the Building Official and these prescriptive provisions are not intended to be the only acceptable strengthening methods permitted. Alternate details and methods shall be permitted when approved by the Building Official. Qualified historical buildings shall be permitted to use alternate building regulations or deviations from this chapter in order to preserve their original or restored architectural elements and features. See California Code of Regulations, Title 24, Part 8 (California Historical Building Code) for these standards.

- C. Alternative design procedures. When analysis by a registered design professional is required or provided for a building within the scope of this chapter, such analysis shall be in accordance with all requirements of this code except as provided in this chapter. The design shall provide strengthening for any structural weakness listed in Section 18.69.030 that is at least equivalent to that provided by the prescriptive requirements of this chapter with respect to strength, deflection and capacity. The Building Official may require that sufficient evidence be submitted to substantiate such equivalence. The base shear may be determined in accordance with the following:

$$V = 0.1375 W(69-1)$$

Where:

V = the total design lateral force or shear at the base

W = the total seismic dead load defined in Section 12.7.2 of ASCE 7-05.

18.69.020 – Definitions.

For the purpose of this chapter, in addition to the applicable definitions, symbols and notations in this code, certain additional terms are defined as follows:

"Adhesive anchor" means a fastener placed in hardened concrete or masonry that derives its holding strength from a chemical adhesive compound placed between the wall of the hole and the embedded portion of the anchor.

"Anchor side plate" means a metal plate or plates used to connect a sill plate to the side of a concrete or masonry stem wall.

"Cripple wall" means a wood-framed stud wall extending from the top of the foundation to the underside of the lowest floor framing.

"Expansion anchor" means a mechanical fastener placed in hardened concrete or assembled masonry, designed to expand in a self-drilled or pre-drilled hole of a specified size and engage the sides of the hole in one or more locations to develop shear and/or tension resistance to applied loads without grout, adhesive or drypack.

"Perimeter foundation" means a foundation system which is located under the exterior walls of a building.

"Snug-tight" is as tight as an individual can torque a nut on a bolt by hand using a wrench with a ten (10) inch long handle and the point at which the full surface of the plate washer is contacting the wood member and slightly indents the wood surface.

"Unreinforced masonry" means and includes adobe, burned clay, concrete or sand-lime brick, hollow clay or concrete block, hollow clay tile, rubble, cut stone, and unburned clay masonry walls in which the area of reinforcement is less than fifty percent (50%) of the minimum steel ratios required for reinforced masonry.

18.69.030 – Structural weaknesses.

- A. Sill plates or floor framing which are supported directly on the ground without an approved foundation system.
- B. A perimeter foundation system which is constructed of wood posts supported on isolated pad footings.
- C. Perimeter foundation systems that are not continuous.

EXCEPTIONS:

- 1. Existing single-story exterior walls not exceeding ten (10) feet in length forming an extension of floor area beyond the line of an existing continuous perimeter foundation.
- 2. Porches, storage rooms and similar spaces not containing fuel burning appliances.
- D. A perimeter foundation system which is constructed of unreinforced masonry.
- E. Sill plates which are not connected to the foundation or are connected with less than what is required by Subsection 18.69.040.C.1.
- F. Cripple walls that are not braced in accordance with the requirements of Subsection 18.69.040.D and Table 69-A.

18.69.040 – Strengthening requirements.

A. General.

- 1. Scope. The structural weaknesses noted in Section 18.69.030 shall be strengthened in accordance with the requirements of this section. Strengthening work shall be allowed to include both new construction and alteration of existing construction. Except as provided herein, all strengthening work and materials shall comply with the applicable provisions of this code. Alternate methods of strengthening shall be allowed provided such systems are designed by a registered design professional and approved by the Building Official.
- 2. Condition of existing wood materials. All existing wood materials which will be a part of the strengthening work shall be in a sound condition and free from defects which substantially reduce the capacity of the member. Any wood material found to contain fungus infection shall be removed and replaced with new material. Any wood material found to be infested with insects or to have been infested shall be strengthened or replaced with new materials to provide a net dimension of sound wood at least equal to its undamaged original dimension.
- 3. Floor joists not parallel to foundations. Floor joists framed perpendicular or at an angle to perimeter foundations shall be restrained by either a nominal two-inch wide continuous rim joist or a nominal two (2) inch wide full depth blocking between alternate joists in one- and two-story buildings, and between each joist in three (3) story buildings. Blocking for multistory buildings must occur at each joist space above a braced cripple wall panel.

Existing connections at the top edge of an existing rim joist or blocking need not be verified. The bottom edge connection to either the foundation sill plate or top plate of a cripple wall shall be verified unless a supplemental connection is provided. The minimum existing bottom edge connection shall consist of 8d toenails spaced six (6) inches apart for a continuous rim joist or three (3) 8d toenails per block. When this minimum bottom edge connection is not present, or is not verified, a supplemental connection shall be provided.

When an existing continuous rim joist or the minimum existing blocking does not occur, new one and one-eighth (1-1/8) inch wood structural panel blocking installed tightly between floor joists and nailed with 10d common nails at four (4) inches on center to the sill or wall top plate shall be provided at the inside face of the cripple wall. In lieu of one and one-eighth (1-1/8)

inch wood structural panel blocking, tight-fitting, full or near full depth two (2) inches nominal width lumber blocking shall be allowed provided it does not split during installation. New blocking is not required where it will interfere with vents or plumbing that penetrates the wall.

4. Floor joists parallel to foundations. Where existing floor joists are parallel to the perimeter foundations, the end joist shall be located over the foundation and, except for required ventilation openings, shall be continuous and in continuous contact with any existing foundation sill plate or top plate of the cripple wall. Existing connections at the top edge connection of the end joist need not be verified; however, the bottom edge connection to either the foundation sill plate or the top plate of a cripple wall shall be verified unless a supplemental connection is provided.

The minimum bottom edge connection shall be 8d toenails spaced six (6) inches apart. If this minimum bottom edge connection is not present or is not verified, a supplemental connection shall be provided.

5. Supplemental connections. Supplemental connections shall provide sufficient strength to transfer the seismic forces. Framing anchors of minimum eighteen (18) gage steel and twelve (12) approved fasteners may be considered to meet this requirement when spaced thirty-two (32) inches on center for one (1) story buildings, twenty-four (24) inches on center for two (2) story buildings and sixteen (16) inches on center for three (3) story buildings.

EXCEPTIONS: A supplemental connection is not required when:

- a. The structural wood panel sheathing extends from the sill plate to the rim joist or blocking above.
 - b. The floor sheathing is nailed directly into the sill or top plate of the cripple wall.
6. Single top plate ties. When a single top plate exists in the cripple wall, all end joints in the top plate shall be tied. Ties shall be connected to each end of the discontinuous top plate and shall be equal to one of the following:
 - a. Three (3) inch by six (6) inch by 0.036-inch thick galvanized steel and nailed with six (6) 8d nails at each end.
 - b. One and one-half (1½) inch by twelve (12) inch by 0.058-inch galvanized steel nailed with six (6) 16d nails at each end.
 - c. Two (2) inch by four (4) inch by twelve (12) inch wood blocking nailed with six (6) 16d nails at each end.

B. Foundations.

1. New perimeter foundations. New perimeter foundations shall be provided for structures with the structural weaknesses noted in Subsections 18.69.030.A and 18.69.030.B. Soil investigations or geotechnical studies are not required for this work unless the building shows signs of excessive settlement or creep.
2. Foundation evaluation by a registered design professional. Partial perimeter foundations or unreinforced masonry foundations shall be evaluated by a registered design professional for the force levels noted in Formula (69-1) of this chapter. Test reports or other substantiating data to determine existing foundation material strengths shall be submitted for review. When approved by the Building Official, these foundation systems may be strengthened in accordance with the recommendations included with the evaluation in lieu of being replaced.

EXCEPTION: In lieu of testing existing foundations to determine material strengths and when approved by the Building Official, a new nonperimeter foundation system, designed for the forces noted in Formula (69-1) of this chapter, may be used to resist all exterior wall lateral forces.

3. Details for new perimeter foundations. All new perimeter foundations shall be continuous and constructed according to the standards for new buildings.

EXCEPTIONS:

- a. When approved by the Building Official, the existing clearance between existing floor joists or girders and existing grade below the floor need not comply with Section 2304.11.2.1 of the California Building Code adopted in Chapter 18.40. This exception shall not be permitted when buildings are relocated on new foundations.
 - b. When approved by the Building Official, and when designed by a registered design professional, partial perimeter foundations may be used in lieu of a continuous perimeter foundation.
- C. Foundation sill plate anchorage.
1. Existing perimeter foundations. When the building has an existing continuous perimeter foundation, all perimeter wall sill plates shall be connected to the foundation in accordance with Table 69-A and this section. Anchors shall be installed with the plate washer installed between the nut and the sill plate. The nut shall be tightened to a snug-tight condition after curing is complete for adhesive anchors and after expansion wedge engagement for expansion anchors.

The installation of nuts on all anchors shall be subject to verification by the Building Official. Torque testing shall be performed for twenty percent (20%) of all adhesive or expansion anchors.

Minimum test values shall be thirty (30) foot-pounds for one-half (1/2) inch and forty (40) foot-pounds for five-eighths (5/8) inch diameter anchors.

Anchor side plates shall be permitted when conditions prevent anchor installation vertically through the sill plate. Anchor side plates shall be spaced as required for adhesive or expansion anchors but only one anchor side plate is required on individual pieces of sill plate less than thirty-two (32) inches in length. Wood structural panel shims shall be used on sill plates for single plate anchor side plates when the foundation stem wall is from three-sixteenths (3/16) inch to three-fourths (3/4) inch wider than the sill plate. The shim length shall extend a minimum of two (2) inches past each end of the anchor side plate. Two (2) plate anchor side plates shall be used when the total thickness of the required shim exceeds three-fourths (3/4) inch.

All anchor side plates which use lag or wood screws shall pre-drill the sill plate to prevent splitting as required by Section 2304.9 of the California Building Code adopted in Chapter 18.40.

Lag or wood screws shall be installed in the center of the thickness of the existing sill plate.

Expansion anchors shall not be used in unreinforced masonry or concrete masonry grout of poor quality. Adhesive anchors shall be required when expansion anchors will not tighten to the required torque or their installation causes surface cracking of the foundation wall.

2. Placement of anchors. Anchors shall be placed within twelve (12) inches, but not less than nine (9) inches, from the ends of sill plates and shall be placed near the center of the stud

space closest to the required spacing. New sill plates may be installed in pieces when necessary because of existing conditions.

The minimum length of new sill plate pieces shall be thirty (30) inches.

EXCEPTION: Where physical obstructions such as fireplaces, plumbing or heating ducts interfere with the placement of an anchor, the anchor shall be placed as close to the obstruction as possible, but not less than nine (9) inches from the end of the plate. Center-to-center spacing of the anchors shall be reduced as necessary to provide the minimum total number of anchors required based on the full length of the wall. Center-to-center spacing shall not be less than twelve (12) inches.

3. New perimeter foundations. Sill plates for new perimeter foundations shall be anchored as required by Section 1805.6 of the California Building Code adopted in Chapter 18.40.

D. Cripple wall bracing.

1. General. Exterior cripple walls not exceeding four (4) feet in height shall use the prescriptive bracing method listed below. Cripple walls more than four (4) feet in height require analysis by a registered design professional in accordance with Chapter 16 of the California Building Code adopted in Chapter 18.40.
2. Sheathing requirements. Wood structural panel sheathing shall not be less than 15/32 inch thick. When used, plywood panels shall be constructed of five (5) or more plies.

All wood structural panels shall be nailed with 8d common nails spaced four (4) inches on center at all edges and at twelve (12) inches on center at each intermediate support with not less than two (2) nails for each stud. Nails shall be driven so that their head or crown is flush with the surface of the sheathing and shall penetrate the supporting member a minimum of one and one-half (1½) inch. When a nail fractures the surface, it shall be left in place and not counted as part of the required nailing. A new 8d nail shall be located within two (2) inches of the discounted nail and hand-driven flush with the sheathing surface.

EXCEPTION: No. 6 × 1-½ inch wood screws may be used for sheathing nailing when bracing materials are installed on the interior face of studs and cement plaster or other brittle finishes are on the exterior of the sheathed wall.

All horizontal joints must occur over nominal two (2) inch by four (4) inch blocking installed with the nominal four (4) inch dimension against the face of the plywood. All vertical joints must occur over studs. Vertical joints at adjoining pieces of wood structural panels shall be centered on existing studs such that there is a minimum one-eighth (1/8) inch between the panels.

Nails shall be placed a minimum of one-half (1/2) inch from the edges of the existing stud. When such edge distance cannot be maintained because of the width of the existing stud, a new stud shall be added adjacent to the existing and connected with 16d common nails at eight (8) inches on center. A minimum of three (3) such nails shall be provided.

3. Distribution and amount of bracing. See Table 69-A for the distribution and amount of bracing required. Bracing for a building with three (3) or more floor levels above cripple wall studs exceeding fourteen (14) inches in height must be designed in accordance with Chapter 16 of the California Building Code adopted in Chapter 18.40.

The braced panel must be at least two (2) times the height of the cripple stud wall but not less than forty-eight (48) inches in width. All panels along a wall shall be nearly equal in length and shall be nearly equally spaced along the length of the wall. Braced panels at ends of walls shall be located as near the end as possible.

Where physical obstructions such as fireplaces, plumbing or heating ducts interfere with the placement of cripple wall bracing, the bracing shall then be placed as close to the obstruction as possible. The total amount of bracing required shall not be reduced because of obstructions, but the required length of bracing need not exceed the length of the wall.

Under floor ventilation openings shall be maintained in accordance with Section 1203.3 of the California Building Code adopted in Chapter 18.40. Braced panels may include under floor ventilation openings when the height of the solid portion of the panel meets or seventy-five percent (75%) of the height of the cripple stud wall.

When the minimum amount of bracing prescribed in Table 69-A cannot be installed due to obstructions along any wall, the bracing must be designed by a registered design professional in accordance with Subsection 18.69.010.C.

4. Stud space ventilation. When bracing materials are installed on the interior face of studs forming an enclosed space between the new bracing and existing exterior finish, each braced stud space must be ventilated. Adequate ventilation and access for future inspection shall be provided by drilling on two (2) inch to three (3) inch diameter round hole through the sheathing nearly centered between each stud at the top and bottom of the cripple wall. Such holes should be spaced a minimum of one (1) inch clear from the sill or top plates. In stud spaces containing sill bolts, the hole shall be located on the center line of the sill bolt but not closer than one (1) inch clear from the nailing edge of the sheathing.

When existing blocking occurs within the stud space, additional ventilation holes shall be placed above and below the blocking or the existing block shall be removed and a new nominal two (2) inch by four (4) inch block installed with the nominal four (4) inch dimension against the face of the plywood. For stud heights less than eighteen (18) inches, only one (1) ventilation hole need be provided.

5. Existing under floor ventilation. Existing under floor ventilation shall not be reduced without providing equivalent new ventilation as close to the existing as possible. New sheathing may be installed around existing vent openings in braced panels when the length of the panel is increased a distance equal to the length of the vent opening or one stud space minimum.

EXCEPTION: For residential buildings with a post and pier foundation system where a new continuous perimeter foundation system is being installed, ventilation shall be provided in accordance with this title.

18.69.050 – Quality control.

- A. Inspection by the Department. All work shall be subject to inspection by the Building Official including, but not limited to:
 1. Placement and installation of new adhesive or expansion anchors or anchor side plates installed in existing foundations;
 2. Placement of required blocking and framing anchors;
 3. Installation and nailing of new cripple wall bracing. The torque testing of sill plate anchors per Subsection 18.69.040.C.1 shall be performed by the Building Inspector.
- B. Special inspection. Special inspection is not required for sill plate anchors installed in existing foundations regulated by the provisions of this chapter. Any work may be subject to special inspection when required by the Building Official or when so designated by the registered design professional of record.

- C. Structural observation. Structural observation is not required for work done under the prescriptive provisions of this chapter. When construction documents for strengthening are prepared by a registered design professional and alternate materials or methods are used, structural observation shall be provided as required in Section 1710 of the California Building Code adopted in Chapter 18.40.
- D. Registered design professional of record's statement. When an alternative design is provided per Subsection 18.69.010.C, the responsible registered design professional of record shall place the following statement on the approved construction document:

1. "I am responsible for this building's seismic strengthening design for the under floor cripple walls and sill bolting in compliance with the minimum seismic resistance standards of Chapter 18.69 of the Long Beach Municipal Code."

or when applicable:

2. "The registered special inspector, required as a condition of the use of structural design stresses requiring continuous inspection, will be responsible to me as required by Section 1704.1 of the California Building Code adopted in Chapter 18.40 of the Long Beach Municipal Code."

TABLE 69-A SILL PLATE ANCHORAGE AND CRIPPLE WALL BRACING^{1,2,3}

Number of Stories Above Cripple Walls	Minimum Sill Plate Connection and Maximum Spacing	Amount of Wall Bracing
One Story	Adhesive or expansion anchors shall be ½ inch minimum diameter spaced at 6 feet maximum center to center.	Each end and not less than 50% of the wall length.
Two Story	Adhesive or expansion anchors shall be ½ inch minimum diameter spaced at 4 feet maximum center to center; or 5/8 inch spaced at 6 feet maximum center to center.	Each end and not less than 70% of the wall length.
Three Story	Adhesive or expansion anchors shall be ½ inch minimum diameter spaced at 2 feet 8 inches maximum center to center; or 5/8 inch minimum diameter spaced at 4 feet maximum center to center.	100% of the wall length.

¹ Plate washers for use with adhesive or expansion anchors shall be two inches by two inches by three-sixteenths inch for one-half-inch diameter anchors and two and one-half inches by two and one-half inches by one-fourth inch for five-eighths-inch diameter anchors.

² Existing sill plate anchor bolts shall be permitted to provide all or a portion of the sill plate connection requirement if:

^{2.1} The anchor bolt is cast in concrete and in sound condition,

^{2.2} The diameter size and maximum spacing meets or exceeds the requirements of this table,

^{2.3} A new plate washer conforming to Footnote 1 is installed, and

^{2.4} The sill plate is connected to a snug-tight condition and torque tested per Subsection 18.69.040.C.1.

³ Anchor side plates shall be permitted when conditions prevent anchor installation vertically through the sill plate.

CHAPTER 18.70 VOLUNTARY EARTHQUAKE HAZARD REDUCTION IN EXISTING WOOD FRAME RESIDENTIAL BUILDINGS WITH SOFT, WEAK OR OPEN FRONT WALLS

- 18.70.010 – Purpose.
- 18.70.020 – Scope.
- 18.70.030 – Definitions.
- 18.70.040 – General requirements for phased construction.
- 18.70.050 – Analysis and design.
- 18.70.060 – Materials of construction.
- 18.70.070 – Required information on construction documents.

CHAPTER 18.70

VOLUNTARY EARTHQUAKE HAZARD REDUCTION IN EXISTING WOOD FRAME RESIDENTIAL BUILDINGS WITH SOFT, WEAK OR OPEN FRONT WALLS

18.70.010 – Purpose.

The purpose of this chapter is to promote the public welfare and safety by reducing the risk of death or injury that may result from the effects of earthquakes on existing wood-frame multi-unit residential buildings. The ground motion of the Northridge earthquake caused the loss of human life, personal injury and property damage in these types of buildings. This chapter creates minimum standards to strengthen the more vulnerable portions of these structures. When fully followed, these minimum standards will substantially improve the performance of these buildings but will not necessarily prevent all earthquake-related damage.

18.70.020 –Scope.

The provisions of this chapter shall apply to all existing wood frame buildings or portions thereof, designed using the Building Code in effect before January 1, 1995, which are used as hotels, lodging houses, congregate residences or apartment houses where:

- A. The ground floor portion of the wood frame structure contains parking or other similar open floor space that causes soft, weak or open front wall lines as defined in this chapter and there exists one or more levels above; or
- B. The walls of any story or basement of wood construction are laterally braced with nonconforming structural materials as defined in this chapter and there exists two or more levels above.

18.70.030 – Definitions.

Notwithstanding the applicable definitions, symbols and notations in this title, the following definitions shall apply for the purposes of this chapter.

"Apartment house" means any building or portion thereof which contains three (3) or more dwelling units, and for the purposes of this chapter, includes residential condominiums.

"Aspect ratio" means the ratio of the height of a wall section to its width.

"Congregate residence" means any building or portion thereof which contains facilities for living, sleeping and sanitation, as required by this code, and may include facilities for eating and cooking, for occupancy by other than a family. A congregate residence may be a shelter, convent, monastery, dormitory, and fraternity or sorority house but does not include jails, hospitals, nursing homes, hotels or lodging houses.

"Cripplewall" means a wood-framed stud wall extending from the top of the foundation wall to the underside of the lowest floor framing.

"Dwelling unit" means any building or portion thereof which contains living facilities, including provisions for sleeping, eating, cooking and sanitation, as required by this code, for not more than one (1) family, or congregate residence for ten (10) or fewer persons.

"Expansion anchor" means an approved mechanical fastener placed in hardened concrete, designed to expand in a self-drilled or pre-drilled hole of a specified size and engage the sides of the hole in one (1) or more locations to develop shear and/or tension resistance to applied loads without grout, adhesive or drypack.

"Groundfloor" means any floor within the wood frame portion of a building whose elevation is immediately accessible from an adjacent grade by vehicles or pedestrians. The ground floor portion of the structure does not include any level that is completely below adjacent grades.

"Guest room" means any room or rooms used or intended to be used by a guest for sleeping purposes. Every one hundred (100) square feet of superficial floor area in a congregate residence shall be considered a guest room.

"Hotel" means any building containing six (6) or more guest rooms intended or designed to be used, rented, hired out to be occupied, or which are occupied for sleeping purposes by guests.

"Level" means a story, basement or under floor space of a building with cripple walls exceeding four (4) feet in height.

"Lodginghouse" means any building or portion thereof containing at least one (1) but not more than five (5) guest rooms where rent is paid in money, goods, labor or otherwise.

"Motel" means a hotel as defined in this chapter.

"Multi-unit residential buildings" means hotels, lodging houses, congregate residences and apartment houses.

"Nonconforming structural materials" means wall bracing materials for seismic loads whose allowable shear value was reduced or whose maximum allowable aspect ratio was decreased since the original building construction. These methods or materials include, but are not limited to cement or gypsum plaster, gypsum wall board, diagonal or let-in bracing, straight or diagonal wood sheathing, particle board and structural wood panels.

"Open frontwall line" means an exterior wall line without vertical elements of the lateral-force-resisting system which requires tributary seismic forces to be resisted by diaphragm rotation or excessive cantilever beyond parallel lines of shear walls. Diaphragms that cantilever more than twenty-five percent (25%) of the distance between lines of lateral-force-resisting elements shall be considered excessive. Exterior exit balconies of six (6) feet or less in width shall not be considered excessive cantilevers.

"Retrofit" means an improvement of the lateral-force-resisting system by alteration of existing structural elements or addition of new structural elements.

"Softwall line" means a wall line whose lateral stiffness is less than required by story drift limitations or deformation compatibility requirements of this chapter. In lieu of analysis, this may be defined as a wall line in a story where the story stiffness is less than seventy percent (70%) of the story above for the direction under consideration.

"Story strength" means the total strength of all seismic-resisting elements sharing the same story shear in the direction under consideration.

"Wallline" means any length of a wall along a principal axis of the building used to provide resistance to lateral loads. Parallel wall lines separated by less than four (4) feet shall be considered one wall line for the distribution of loads.

"Weakwall line" means a wall line laterally braced with nonconforming structural materials or a wall line in a story where the story strength is less than eighty percent (80%) of the story above in the direction under consideration.

18.70.040 – General requirements for phased construction.

When the building contains three (3) or more levels, the work specified in this chapter shall be permitted to be done in the following phases. Work shall start with Phase 1 unless otherwise approved by the Building Official. When the building does not contain the conditions shown in any phase, the sequence of retrofit work shall proceed to the next phase in numerical order.

- A. Phase 1 Work. The first phase of the retrofit work shall include the ground floor portion of the wood structure that contains parking or other similar open floor space.
- B. Phase 2 Work. The second phase of the retrofit work shall include the walls of any level of wood construction with two (2) or more levels above, which are laterally braced with nonconforming structural materials.
- C. Phase 3 Work. The third and final phase of the retrofit work shall include the remaining portions of the building up to, but not including, the top story as specified in Subsection 18.70.050.B.

18.70.050 – Analysis and design.

- A. General. Every building within the scope of this chapter shall be analyzed, designed and constructed in conformance with this code except as modified herein. No alteration of the existing lateral-force-resisting or vertical load-carrying system shall reduce the strength or stiffness of the existing structure.
- B. Scope. This chapter requires the alteration, repair, replacement or addition of structural elements and their connections to meet the strength and stiffness requirements herein. The lateral load path analysis shall include the resisting elements and connections from the wood diaphragm above any soft, weak or open front wall lines to the foundation soil interface or reinforced concrete slab or masonry wall supporting elements below. The top story of any building need not be analyzed. The lateral load path analysis for added structural elements shall also include evaluation of the allowable soil bearing and lateral pressures in accordance with Section 1803 of the California Building Code adopted in Chapter 18.40.

EXCEPTION: When an open front, weak or soft wall line exists due to parking at the ground level of a two-level building and the parking area is less than twenty percent (20%) of the ground floor level, then only the wall lines in the open, weak or soft directions of the enclosed parking area, need comply with the provisions of this chapter.

- C. Design base shear. The design base shear shall be seventy-five percent (75%) of that currently required by ASCE 7-05 Section 12.8.1.
- D. Vertical distribution of forces. The total seismic force shall be distributed over the height of the structure based on Formula (12.8-11 and 12.8-12) in ASCE 7-05 Section 12.8.3. Distribution of force by story weight shall be permitted for two-story buildings. The value of R used in the design of any story shall be less than or equal to the value of R used in the given direction for the story above.
- E. Weak story limitation. The structure shall not exceed thirty (30) feet in height or two (2) levels if the lower level strength is less than sixty-five percent (65%) of the story above. Existing walls shall be strengthened as required to comply with this provision unless the weak level can resist a total lateral seismic force of Ω_o per Subsection 18.70.050.C times the design force prescribed in Subsection 18.70.050.D. The story strength for each level of all other structures shall be a minimum of eighty percent (80%) of the story above.
- F. Story drift limitation. The calculated story drift for each retrofitted level shall not exceed the allowable deformation compatible with all vertical load-resisting elements and 0.005 or $0.04/R$ times the story height. The calculated story drift shall not be reduced by the effects of horizontal diaphragm stiffness but shall be increased when these effects produce rotation. The effects of rotation and soil stiffness shall be included in the calculated story drift when lateral loads are

resisted by vertical elements whose required depth of embedment is determined by pole formulas such as Equation (18-1), (18-2) and (18-3) in Section 1807.3.2 of the California Building Code adopted in Chapter 18.40. The coefficient of variation of subgrade reaction used in the deflection calculations shall be provided from an approved geotechnical engineering report or other approved methods.

- G. $P\Delta$ effects. The requirements of ASCE 7-05 Section 12.8.7 shall apply except as modified herein. All framing elements not required by the design to be part of the lateral-force-resisting system shall be investigated and shown to be adequate for vertical load-carrying capacity when displaced Ω_0 per Subsection 18.70.050.C times the displacements resulting from the required lateral force. The stress analysis of cantilever columns shall use a buckling factor of 2.1 for the direction normal to the axis of the beam.
- H. Ties and continuity. All parts of the structure included in the scope of Subsection 18.70.050.B shall be interconnected and the connection shall be capable of resisting the seismic force created by the parts being connected. Any smaller portion of a building shall be tied to the remainder of the building with elements having a strength of 0.1833 times the tributary dead load of the smaller portion.

A positive connection for resisting a horizontal force acting parallel to the member shall be provided for each beam, girder or truss included in the lateral load path. This force shall not be less than 0.08 times the combined tributary dead and live loads or as required by the lateral load path transfer, whichever is greater.

- I. Collector elements. Collector elements shall be provided which can transfer the seismic forces originating in other portions of the building to the elements within the scope of Subsection 18.70.050.B that provide resistance to those forces.
- J. Horizontal diaphragms. The analysis of shear demand or capacity of an existing plywood or diagonally sheathed horizontal diaphragm need not be investigated unless the diaphragm is required to transfer lateral forces from the lateral-resisting elements above the diaphragm to other lateral-force-resisting elements below the diaphragm due to offset in placement of the elements. Wood diaphragms in structures that support floors or roofs above shall not be allowed to transmit lateral forces by rotation or cantilever. However, rotational effects shall be accounted for when unsymmetric wall stiffness increases shear demands.

EXCEPTION: Diaphragms that cantilever twenty-five percent (25%) or less of the distance between lines of lateral-force-resisting elements from which the diaphragm cantilevers may transmit their shears by cantilever provided that rotational effects on shear walls parallel and perpendicular to the load are accounted for.

- K. Shear walls. Shear walls shall have sufficient strength and stiffness to resist the tributary seismic loads and shall conform to the special requirements of this subsection.
1. Gypsum or plaster products. Gypsum or plaster products shall not be used to provide lateral resistance.
 2. Wood structural panels.
 - a. Drift limit. Wood structural panel shear walls shall meet the story drift limitation of Subsection 18.70.050.G. Conformance to the story drift limitation shall be determined by approved testing or calculation or analogies drawn therefrom and not the use of an aspect ratio. Calculated deflection shall be in accordance with Section 2305.3.2 of the California Building Code adopted in Chapter 18.40 and twenty-five percent (25%) shall be added to account for inelastic action and repetitive loading. Contribution to the deflection from the anchor or tie down slippage shall also be included. The slippage contribution shall include the vertical elongation of the metal, the vertical slippage of the connectors

and compression or shrinkage of the wood elements. The vertical slippage shall be multiplied by the aspect ratio and added to the total horizontal deflection. Individual shear panels shall be permitted to exceed the maximum aspect ratio provided the story drift and allowable shear capacities are not exceeded.

- b. Openings. Openings are permitted in shear walls if they do not exceed fifty percent (50%) of the height or width of the shear wall. The remaining portion of the shear wall shall be strengthened for the transfer and increase of all shearing forces caused by the opening. The resulting shear wall shall be analyzed as a mosaic of shear-resisting elements. Blocking and steel strapping shall be employed at the corners of the opening to transfer forces from discontinuous boundary elements into adjoining panel elements.

The effects of openings on the stiffness of the shear wall shall be demonstrated to comply with the requirements of Subsection 18.70.050.F. The stiffness shall be calculated using the properties of the different shear elements making up the shear wall or it shall be demonstrated by approved testing. When shear walls cannot be made to conform to the requirements of this section because of existing openings, the openings shall be relocated or reduced in width to meet the strength and stiffness requirements of the lateral loads. Relocated and altered openings shall comply with the emergency escape requirements in Chapter 10 of the California Building Code adopted in Chapter 18.40. Relocated and altered openings shall comply with the light and ventilation requirements in Chapter 12 of the California Building Code adopted in Chapter 18.40 or Chapter 3 of the California Residential Code adopted in Chapter 18.41 unless otherwise approved by the Building Official.

- c. Wood species of framing members. Allowable shear values for wood structural panels shall consider the species of the framing members. When the allowable shear values are based on Douglas Fir-larch framing members and framing members are constructed of other species of lumber, the allowable shear values shall be multiplied by the appropriate factors determined in accordance with Chapter 23 of the California Building Code adopted in Chapter 18.40.
3. Mechanical penetrations. Mechanical penetrations in shear walls that exceed the provisions of Chapter 23 of the California Building Code adopted in Chapter 18.40 or the California Building Code adopted in Chapter 18.40 or the California Residential Code adopted in Chapter 18.41 shall be accounted for in the design or the shear wall shall be analyzed as two separate walls on each side of the penetration.
 4. Substitution for three-inch nominal width framing members. Two (2) two-inch nominal width framing members shall be permitted in lieu of any required three-inch nominal width framing member when the existing and new framing member are of equal dimensions, are connected as required to transfer the in-plane shear between them and the sheathing fasteners are equally divided between them.
 5. Hold-down connectors.
 - a. Expansion anchors in tension. Expansion anchors that provide tension strength by friction resistance shall not be used to connect hold down devices to existing concrete or masonry elements. Expansion anchors shall be permitted to provide tension strength by bearing.
 - b. Required depth of embedment. The required depth of embedment or edge distance for the anchor used in the hold down connector shall be provided in the concrete or masonry below any plain concrete slab unless satisfactory evidence is submitted to the Building Official that shows that the concrete slab and footings are of monolithic construction.

- c. Required preload of bolted hold-down connectors. Bolted hold down connectors shall be preloaded to reduce slippage of the connector. Preloading shall consist of tightening the nut on the tension anchor after the placement but before the tightening of the shear bolts in the panel flange member. The tension anchor shall be tightened until the shear bolts are in firm contact with the edge of the hole nearest the direction of the tension anchor. Hold down connectors with self-jigging bolt standoffs shall be installed in a manner to permit preloading.

18.70.060 – Materials of construction.

- A. New materials. All materials approved by this title, including their appropriate allowable stresses and minimum aspect ratios, shall be permitted to meet the requirements of this chapter.
- B. Allowable foundation and lateral pressures. Allowable foundation and lateral pressures shall be permitted to use the values from Table 1806.2 of the California Building Code adopted in Chapter 18.40. The coefficient of variation of subgrade reaction shall be established by an approved geotechnical engineering report or other approved methods when used in the deflection calculations of embedded vertical elements as required in Subsection 18.70.050.F.
- C. Existing materials. All existing materials shall be in sound condition and constructed in conformance to this code before they can be used to resist the lateral loads prescribed in this chapter. The verification of existing material conditions and their conformance to these requirements shall be made by physical observation reports, material testing or record drawings as determined by the responsible registered design professional of record and approved by the Building Official.
 - 1. Horizontal wood diaphragms. Existing horizontal wood diaphragms that require analysis under Subsection 18.70.050.J shall be permitted to use Table A-23-C of Chapter 18.68 this title for their allowable values.
 - 2. Wood structural panel shear walls.
 - a. Allowable nail slip values. When the required drift calculations of Subsection 18.70.050.K.2.a rely on the lower slip values for common nails or surfaced dry lumber, their use in construction shall be verified by exposure. The use of box nails and unseasoned lumber may be assumed without exposure. The verification of surfaced dry lumber shall be by identification conforming to Chapter 23 of the California Building Code adopted in Chapter 18.40.
 - b. Reduction for clipped nail heads. When exposed nails do not meet the nominal head sizes required for hand-driven nails in Chapter 23 of the California Building Code adopted in Chapter 18.40, the allowable shear capacity for wood structural panel shear walls shall be proportionately reduced. The reduction shall be a percentage of the reduction in the nail head area below the required nail head area including tolerances.
 - c. Plywood panel construction. When verification of the existing plywood materials is by use of record drawings alone, the panel construction for plywood shall be assumed to be of three plies.
 - d. Framing members of other species. When verification of the existing wood material is by use of record drawings, the allowable shear capacity shall be multiplied by the reduction factor of 0.82 for buildings built on or after 1960. Buildings built before this period shall use the reduction factor 0.65. When verification of the existing wood material is by identification in conformance to Chapter 23 of the California Building Code adopted in Chapter 18.40, the allowable shear capacity shall be determined in accordance with Subsection 18.70.050.K.2.c.

3. Lumber. When the existing dimensioned lumber is not identified in conformance to Chapter 23 of the California Building Code adopted in Chapter 18.40, the allowable stresses shall be permitted for the structural elements specified below.

Posts and Beams	Douglas Fir-larch No. 1
Joists and Rafters	Douglas Fir-larch No. 2
Studs, Blocking	Hem Fir Stud

4. Structural steel. All existing structural steel shall be permitted to use the allowable stresses for Grade A36. Existing pipe or tube columns shall be assumed to be of minimum wall thickness unless verified by testing or exposure.
5. Strength of concrete. All existing concrete footings shall be permitted to use the allowable stresses for plain concrete with a compressive strength of two thousand (2,000) psi. The strength of existing concrete with a record compressive strength greater than two thousand (2,000) psi shall be verified by testing, record drawings or Department records.
6. Existing sill plate anchorage. Existing cast-in-place anchor bolts shall be permitted to use the allowable service loads for bolts with proper embedment when used for shear resistance to lateral loads.

18.70.070 – Required information on construction documents.

- A. General. The construction documents shall show all necessary dimensions and materials for plan review and construction and shall accurately reflect the results of the engineering investigation and design.
- B. Existing construction. The construction documents shall show the existing diaphragm and shear wall sheathing and framing materials, fastener type and spacing, diaphragm and shear wall connections, continuity ties, and collector elements. The plans shall also show the portion of the existing materials that needs verification during construction.
- C. New construction.
 1. Foundation plan elements. The foundation plan shall include the size, type, location and spacing of all anchor bolts with the required depth of embedment, edge and end distance; the location and size of all columns for braced or moment frames; referenced details for the connection of braced or moment frames to their footing; and referenced sections for any grade beams and footings.
 2. Framing plan elements. The framing plan shall include the width, location and material of shear walls; the width, location and material of frames; references on details for the column-to-beam connectors, beam-to-wall connections, and shear transfers at floor and roof diaphragms; and the required nailing and length for wall top plate splices.
 3. Shear wall schedule, notes and details. Shear walls shall have a referenced schedule on the construction documents that includes the correct shear wall capacity in pounds per foot; the required fastener type, length, gauge and head size; and a complete specification for the sheathing material and its thickness. The schedule shall also show the required location of three-inch nominal or two (2) two-inch nominal edge members; the spacing of shear transfer elements, such as framing anchors or added sill plate nails; the required hold down with its

bolt, screw or nail sizes; and the dimensions, lumber grade and species of the attached framing member.

Notes shall show required edge distance for fasteners on structural wood panels and framing members; required flush nailing at the plywood surface; limits of mechanical penetrations; and the sill plate material assumed in the design. The limits of mechanical penetrations shall also be detailed showing the maximum notching and drilled hole sizes.

4. General notes. General notes shall show the requirements for material testing, special inspection, structural observation and the proper installation of newly added materials.
5. Registered design professional of record's statement. The responsible registered design professional of record shall provide the following statements on the approved construction documents:
 - a. "I am responsible for designing this building's seismic strengthening in compliance with the minimum seismic resistance standards of Chapter 18.70 of the Long Beach Municipal Code."

and when applicable:

 - b. "The Registered Special Inspector, required as a condition of the use of structural design stresses requiring continuous inspection, will be responsible to me as required by Section 1704.1 of the California Building Code adopted in Chapter 18.40 of the Long Beach Municipal Code."

CHAPTER 18.71 VOLUNTARY EARTHQUAKE HAZARD REDUCTION IN EXISTING REINFORCED CONCRETE BUILDINGS AND CONCRETE FRAME BUILDINGS WITH MASONRY INFILLS

- 18.71.010 – Purpose.
- 18.71.020 – Scope.
- 18.71.030 – Definitions.
- 18.71.040 – General requirements.
- 18.71.050 – Criteria selection.
- 18.71.060 – Dynamic lateral analysis procedure.
- 18.71.070 – Equivalent lateral force procedure.
- 18.71.080 – Simplified analysis procedure.
- 18.71.090 – Minimum requirements for a limited structural analysis.
- 18.71.100 – Determination of the stress-strain relationship of existing unreinforced masonry.
- 18.71.110 – Evaluation of existing structural conditions.
- 18.71.120 – Materials of construction.
- 18.71.130 – Information required on the construction documents.

CHAPTER 18.71

VOLUNTARY EARTHQUAKE HAZARD REDUCTION IN EXISTING REINFORCED CONCRETE BUILDINGS AND CONCRETE FRAME BUILDINGS WITH MASONRY INFILLS

18.71.010 – Purpose.

The purpose of this chapter is to promote public safety and welfare by reducing the risk of death or injury that may result from the effects of earthquakes on concrete buildings and concrete frame buildings with masonry infills. The Northridge Earthquake caused widespread damage to these buildings, including some collapses.

The recent Great Hanshin earthquake in Kobe, Japan, also caused several hundred of these buildings to collapse. These nonductile concrete buildings are frequently used in Long Beach for department stores, office buildings, hotels, parking structures and some mid-rise condominiums. Their performance in an earthquake is essential to the life and safety of their occupants and the overall stability of the local economy. This chapter provides voluntary retrofit standards that, when fully followed, will substantially improve the seismic performance of these buildings but will not necessarily prevent all earthquake damage.

18.71.020 – Scope.

The provisions of this chapter may be applied to all buildings designed under Building Codes in effect prior to January 13, 1976, or built with building permits issued prior to January 13, 1977, having concrete floors and/or concrete roofs supported by reinforced concrete walls or concrete frames and columns, and/or concrete frames with masonry infills.

18.71.030 – Definitions.

For purposes of this chapter, the applicable definitions and notations in Sections 1602, 1613.2 and 1902 of the California Building Code adopted in Chapter 18.40 and the following definition shall apply:

"Masonry infill" means the unreinforced or reinforced masonry wall construction within a reinforced concrete frame.

18.71.040 – General requirements.

When the owner of each building within the scope of this chapter causes an investigation of the existing construction, a structural analysis shall be made of the building by a registered design profession licensed by the State of California.

EXCEPTION: Regular concrete shear wall buildings, of four (4) stories in height and under, may be shown to be in conformance with this chapter by filing a report signed by a registered design profession licensed by the State of California containing the information specified in Section 18.71.090.

18.71.050 – Criteria selection.

- A. Basis for analysis. The building shall be analyzed to determine the displacements caused by inertial force effects determined in accordance with the dynamic lateral analysis procedure of Section 18.71.060. The building structural system shall provide a complete load path for resisting the effects of seismic loading. The capacity of all parts of the structural system shall exceed the demand calculated by the dynamic analysis using the effective stiffnesses determined by a nonlinear analysis of the elements.

EXCEPTION: Buildings conforming to the requirements of Subsections 18.71.050.D.2 and 18.71.050.D.3 may be analyzed using the procedure specified in Sections 18.71.070 and 18.71.080, respectively.

B. Site geology and soil characteristics. In the absence of a soils investigation, the soil site class shall be taken as Type D.

C. Configuration requirements.

1. General. Each structure shall be designated as structurally regular or irregular.

2. Regular structures. Regular structures have no significant physical discontinuities in plan or vertical configuration or in their lateral-force-resisting systems such as the irregular features described below.

a. Irregular structures have significant physical discontinuities in configuration or in their lateral-force-resisting systems. Irregular features include, but are not limited to, those described in Tables 12.3-1 and ASCE 7-05 Section 12.3-2.

b. Structures having one or more of the features listed in Table 12.3-2 of ASCE 7-05 shall be designated as having a vertical irregularity.

EXCEPTION: Where none of the story drift ratios under equivalent lateral forces is greater than 1.3 times the story drift ratio of the story above, the structure may be deemed to not have the structural irregularities of Type 1 or 2 listed in Table 12.3-2 of ASCE 7-05. The story drift for this determination shall be calculated including torsional effects.

c. Structures having one (1) or more of the features listed in Table 12.3-1 of ASCE 7-05 shall be designated as having a plan irregularity.

d. Irregular structures conforming to the requirements of Subsection 18.71.050.D and Section 18.71.080 may be considered regular if the plan and vertical irregularities are removed by the addition of lateral load-resisting systems.

D. Selection of lateral analysis procedure.

1. General. Any structure may be analyzed using the dynamic lateral analysis procedures of Section 18.71.060. The equivalent lateral force procedure or the simplified analysis may be used for structures conforming to the requirements on the use of those analyses.

2. Equivalent lateral force. The equivalent lateral force procedure of Section 18.71.070 may be used for regular structures or irregular structures having plan irregularity only of not more than four (4) stories.

3. Simplified analysis. Regular structures of not more than four (4) stories conforming to the requirements of Section 18.71.080 may be analyzed for a prescribed strength of their systems and elements.

E. Alternative procedures.

1. General. Alternative lateral analysis procedures using rational analyses based on well-established principles of mechanics may be used in lieu of those prescribed in this chapter when approved by the Building Official.

2. Seismic isolation. Seismic isolation (Chapter 17 of ASCE 7-05, Seismic Design Requirements for Seismically Isolated Structures), energy dissipation and damping systems may be used to

reduce story drift when approved by the Building Official. The isolated structure shall comply with the drift requirements of Section 18.71.060.

18.71.060 – Dynamic lateral analysis procedure.

- A. General. Structures shall be analyzed for seismic forces acting concurrently on the orthogonal axes of the structure. The effects of the loading on two orthogonal axes shall be combined by the square root of the sum of the squares (SRSS) methods.
- B. Ground motion. The seismic ground motion values shall be determined in accordance with ASCE 7-05 and may be one of the following:
 - 1. The elastic design response spectrum shall be seventy-five percent (75%) of the response spectrum described in ASCE 7-05 Section 11.4.5.
 - 2. A site-specific response spectrum shall be seventy-five percent (75%) of the site-specific response spectrum described in ASCE 7-05 Section 11.4.7.
- C. Mathematical model. The three-dimensional mathematical model of the physical structure shall represent the spatial distribution of mass and stiffness of the structure to an extent which is adequate for the calculation of the significant features of its dynamic response. All concrete and masonry elements shall be included in the model of the physical structure.

EXCEPTION: Concrete or masonry partitions that are adequately isolated from the concrete frame members and the floor above.

Cast-in-place reinforced concrete floors with span-to-depth ratios less than three (3) to one (1) may be assumed to be rigid diaphragms. Other floors, including floors constructed of precast elements with or without a reinforced concrete topping, shall be analyzed in conformance with ASCE 7-05 Section 12.3.1.3 to determine if they must be considered as flexible diaphragms. The effective in-plane stiffness of the diaphragm, including effects of cracking and discontinuity between precast elements, shall be considered. Ramps that interconnect floor levels shall be modeled as having mass appropriately distributed on that element. The lateral stiffness of the ramp may be calculated as having properties based on the uncracked cross section of the slab exclusive of beams and girders.

- D. Effective stiffness.
 - 1. General. The effective stiffness of concrete and masonry elements or systems shall be calculated as the secant stiffness of the element or system with due consideration of the effects of tensile cracking and compression strain. The secant stiffness shall be taken from the force-displacement relationship of the element or system. The secant stiffness shall be measured as the slope from the origin to the intersection of the force-displacement relationship at the assumed displacement. The force-displacement relationship shall be determined by a nonlinear analysis. The force-displacement analysis shall include the calculation of the displacement at which strength degradation begins.

EXCEPTION: The initial effective moment of inertia of beams and columns in shear wall or infilled frame buildings may be estimated using Table 71-B. The ratio of effective moment of inertia used for the beams and for the columns shall be verified by Formulas (71-1), (71-2) and (71-3). The estimates shall be revised if the ratio used exceeds the ratio calculated by more than twenty percent (20%).

$$I_e = \left(\frac{M_{cr}}{M_a}\right)^3 I_g + \left[1 - \left(\frac{M_{cr}}{M_a}\right)^3\right] I_{cr} \quad (71-1)$$

WHERE:

$$M_{cr} = \frac{f_r I_g}{y_t} \quad (71-2)$$

and

$$f_r = 7.5 \sqrt{f'_c} \quad (71-3)$$

2. Infills. The effective stiffness of an infill shall be determined from a nonlinear analysis of the infill and the confining frame. The effect of the infill on the stiffness of the system shall be determined by differencing the force-displacement relationship of the frame-infill system from the frame-only system.
3. Model of infill. The mathematical model of an infilled frame structure shall include the stiffness effects of the infill as a pair of diagonals in the bays of the frame. The diagonals shall be considered as having concrete properties and only axial loads.

Their lines of action shall intersect the beam-column joints. The secant stiffness of the force-displacement relationship, calculated as prescribed in Subsection 18.71.060.D.2, shall be used to determine the effective area of the diagonals. The effective stiffness of the frame shall be determined as specified in Subsection 18.71.060.D.1. Other procedures that provide the same effective stiffness for the combination of infill and frame may be used when approved by the Building Official.

4. Effective stiffness of elements and systems. The effective stiffness shall be determined by an iterative method. The mathematical model using assumed effective stiffness shall be used to calculate dynamic displacements. The effective stiffness of all concrete and masonry elements shall be modified to represent the secant stiffness obtained from the nonlinear force displacement analysis of the element or system at the calculated displacement. A reanalysis of the mathematical model shall be made using the adjusted effective stiffness of existing and supplemental elements and systems until closure of the iterative process is obtained. A difference of ten percent (10%) from the effective stiffness used and that recalculated may be assumed to be closure of the iterative process.

E. Description of analysis procedures.

1. Response spectrum analysis. Response spectrum analysis is an elastic dynamic analysis of a structure utilizing the peak dynamic response of all modes having a significant contribution to total structural response. Peak modal responses are calculated using the ordinates of the appropriate response spectrum curve that correspond to the modal periods. Maximum modal contributions are combined in a statistical manner to obtain an approximate total structural response.
2. Number of modes. The requirement of Subsection 18.71.060.E.1 may be satisfied by demonstrating that for the modes considered, at least ninety percent (90%) of the participating mass of the structure is included in the calculation of response for each principal horizontal direction.
3. Combining modes. The peak displacements for each mode shall be combined by recognized methods. Modal interaction effects of three-dimensional models shall be considered when combining modal maxima.

4. Torsion. The three-dimensional analysis shall be considered as including all torsional effects including accidental torsional effects.
- F. Material characteristics. The stress-strain relationship of concrete, masonry and reinforcement shall be determined by testing or from published data. The procedure for testing and determination of stress-strain values shall be as prescribed in one of the following:
1. Concrete. The compressive strength of existing concrete shall be determined by tests on cores sampled from the structure or may be taken from information given on the construction documents and confirmed by limited testing. A default value of horizontal shear stress may be used in Subsection 18.71.080.E.1 without testing of the compressive strength of the existing concrete.
 - a. The cutting of cores shall not significantly reduce the strength of the existing structure. Cores shall not be taken in columns. Existing reinforcement shall not be cut.
 - b. If the construction documents do not specify a minimum compressive strength of the classes of concrete, five (5) cores per story, with a minimum of ten (10) cores, shall be obtained for testing. Exception: If the coefficient of variation of the compressive strength does not exceed fifteen percent (15%), the number of cores per story may be reduced to two (2) and the minimum number of tests reduced to five (5).
 - c. When the construction documents specify a minimum compressive strength, two (2) cores per story, per class of concrete, shall be taken in the areas where that concrete was to be placed. A minimum of five (5) cores shall be obtained for testing. If a higher strength of concrete was specified for columns than the remainder of the concrete, cores taken in the beams for verification of the specified strength of the beams shall be substituted for tests in the columns. The strength specified for columns may be used in the analyses if the specified compressive strength in the beams is verified.
 - d. The sampling for the concrete strength tests shall be distributed uniformly in each story. If the building has shear walls, a minimum of fifty percent (50%) of the cores shall be taken from the shear walls. Not more than twenty-five percent (25%) of the required cores shall be taken in floor and roof slabs. The remainder of cores may be taken from the center of beams at mid-span. In concrete frame buildings, seventy-five percent (75%) of the cores shall be taken from the beams.
 - e. The mean value of the compressive stresses obtained from the core testing for each class of concrete shall be used in the analyses. Values of peak strain that is associated with peak compressive stress may be taken from published data for the nonlinear analyses of reinforced concrete elements.
 2. Solid grouted reinforced masonry. The compressive strength of solid grouted concrete block or brick masonry may be taken as two thousand (2,000) psi. The strain associated with peak stress may be taken as 0.0025.
 3. Partially grouted masonry. A minimum of five (5) units shall be removed from the walls and tested in conformance with ASTM C90-03 Specification for Load Bearing Concrete Masonry Units. Compressive strength of the masonry may be determined in accordance with Chapter 21 of the California Building Code adopted in Chapter 18.40, assuming Type S mortar. The strain associated with peak stress may be taken as 0.0025.
 4. Unreinforced masonry.
 - a. The stress-strain relationship of existing unreinforced masonry shall be determined by in-place cyclic testing. The test procedure shall conform to Section 18.71.100.

- b. One (1) stress-strain test per story and a minimum of five (5) tests shall be made in the unreinforced masonry infills. The location of the tests shall be uniformly distributed throughout the building.
 - c. The average values of the stress-strain values obtained from testing shall be used in the nonlinear analyses of frame-infill assemblies or in the calculation of the effective diagonal brace that is used in the simplified analysis procedure of Section 18.71.080.
5. Reinforcement. The yield stress of each type of new or existing reinforcement shall be taken from Table 71-C unless the reinforcement is sampled and tested for yield stress. The axial reinforcement in columns of post-1933 buildings shall be assumed to be hard grade unless noted otherwise on the construction documents.
6. Combination of concrete and masonry materials. Combinations of masonry and concrete infills shall be assumed to have equal strain. The secant moduli at peak stress of the masonry and concrete shall be used to determine the effective transformed area of the composite material.
- G. Story drift limitation.
1. Definition. Story drift is the displacement of one level relative to the level above or below calculated by the response spectrum analysis using the appropriate effective stiffness.
 2. Limitation. The story drift is limited to that displacement that causes any of the following effects:
 - a. Compressive strain of 0.003 in the frame confining infill or in a shear wall.
 - b. Compressive strain of 0.004 in a reinforced concrete column unless the engineer can show by published experimental research that the existing confinement reinforcement justifies higher values of strain.
 - c. Peak strain in masonry infills as determined by experimental data or by physical testing as prescribed in Section 18.71.100.
 - d. Displacement that was calculated by the nonlinear analysis as when strength degradation of any element began.

EXCEPTION: This subsection may be taken as the displacement that causes a strength degradation in that line of resistance equal to ten percent (10%) of the sum of the strength of the elements in that line of resistance.
- e. A story drift of 0.015 using the dynamic analysis procedure or the forces specified in Section 18.71.070. This limitation shall not supersede the limitations of Subsections 18.71.060.G.2.a through 18.71.060.G.2.d.
- H. Compressive strain determination.
1. General. The compressive strain in columns, shear walls and infills may be determined by the nonlinear analysis or a procedure that assumes plane sections remain plane.
 2. Axial and flexural loading. The compressive strain shall be determined for combined flexure and axial loading. The flexural moments shall be taken from the response spectrum model for frame or shear wall buildings, and from the substructure model for infill frames. The axial loads shall have the following combination of effects, where L is unreduced live load:

$$U = 1.0D + 0.3L + 1.0E(71-4)$$

$$U = 0.9D - 1.0E(71-5)$$

- I. Shear strength limitation. The required in-plane shear strength of all columns, piers and shear walls shall be the shear associated with the moments induced at the ends of columns or piers and at the base of shear walls by the story displacements. No strength reduction factors shall be used in the determination of strength.

18.71.070 – Equivalent lateral force procedure.

- A. General. Structures shall be analyzed for prescribed forces acting concurrently on the orthogonal axes of the building. The effects of the loading on the two (2) orthogonal axes shall be combined as required by Subsection 18.71.060.A.
- B. Base Shear for Analysis. The base shear used to determine story drifts shall be determined using seventy-five percent (75%) of the base shear as determined in accordance with ASCE 7-05 Section 12.8.1.

Where:

R = 1.4 for concrete frame buildings with masonry infill and all other reinforced concrete buildings.

EXCEPTION: R = 1.0 for single-story buildings. The R value in ASCE 7-05 Table 12.2-1 for new building design shall not be used for story drift determination.

- C. Structure period. The value of T may be determined by either Method A or B as prescribed by ASCE 7-05 Section 12.8.2. The structure period calculated by Method B need not be limited to a percent of the value obtained by Method A.
- D. Vertical distribution of forces. The base shear shall be distributed over the height of the structure in conformance with Formula (71-6).

$$C_{vx} = \frac{w_x h_x^k}{\sum_{i=1}^{i=n} w_i h_i^k} \quad (71-6)$$

Where:

C_{vx} = vertical distribution factor to be applied to V to obtain the story force at level x.

k = an exponent related to building period as follows:

For buildings having a period of 0.4 seconds or less,

$$k = 1.0$$

For buildings having a period of 2.0 seconds or more,

$$k = 2.0$$

For buildings having a period between 0.4 and 2.0 seconds, k may be taken as two (2) or determined by linear interpolation between one (1) and two (2).

- E. Horizontal distribution of shear. The effective stiffness of elements shall be used for the horizontal distribution of shear.
- F. Horizontal torsional moments. Provision shall be made for increased displacements resulting from horizontal torsion. The effects of torsional moments shall be included in the determination of the effective stiffness of elements and systems. Reinforced concrete floors may be considered as rigid diaphragms.
- G. Effective stiffness. The effective stiffness of concrete and masonry elements shall be determined as prescribed in Subsection 18.71.060.D.
- H. Material characteristics. Material characteristics shall be determined as prescribed in Subsection 18.71.060.F.
- I. Story drift limitations. Story drift limits shall be as prescribed in Subsection 18.71.060.G.
- J. Compressive strain determination. Compressive strain shall be determined as prescribed in Subsection 18.71.060.H.
- K. Shear strength limitation. The in-plane shear strength shall equal or exceed the shear forces determined as prescribed in Subsection 18.71.060.I.

18.71.080 – Simplified analysis procedure.

- A. General. Structures conforming to the requirements of this section may be analyzed for having a required strength by a simplified analysis procedure.
- B. Required features of the building. The building shall conform to all the following features, or the building shall be analyzed by the equivalent lateral force procedure or the dynamic lateral force procedure as prescribed by Subsection 18.71.050.D.
 - 1. The lateral-resisting elements of the building shall be reinforced concrete shear walls or frames with solid masonry infills and infills which have openings in the masonry infills not exceeding ten percent (10%) of the gross area of the infill panel which has the opening(s).
 - 2. The effective shear area of reinforced concrete shear walls on each orthogonal axis shall be calculated by passing a horizontal plane through each story level. The height of the plane shall be that height where the area of the shear walls is a minimum.
 - 3. The reinforced concrete elements shall have no visible deterioration of concrete or reinforcement.
 - 4. The vertical elements in the lateral-load-resisting system shall not have significant strength discontinuities; the story strength in any story shall not be less than ninety percent (90%) of the strength of the story above.
 - 5. The lateral-force-resisting elements in all story levels shall form a system that is not subject to significant torsion. Significant torsion is the condition where the distance between the story center of rigidity and the story center of mass is greater than twenty percent (20%) of the width of the structure in the corresponding plan dimension.
 - 6. The minimum ratio of area of reinforcement to gross area of wall in existing reinforced concrete shear walls shall be 0.0015 in both the vertical and horizontal direction or the minimum ratio of axial reinforcement in the columns of frames containing infills shall be 0.01.
 - 7. The ratio of total height to base length of cantilevered or coupled shear walls shall be two (2) or less. The ratio of clear height to in-plane depth of piers in a shear wall shall be two (2) or

less. Shear walls or piers having a height to in-plane depth ratio greater than two (2) shall be given an effective shear area of one-half (1/2) their area.

8. All concrete frames with infilled panels conforming to Subsection 18.71.080.B.1 above shall have total height to base length ratios of two (2) to one (1) or less.

C. Analysis procedure.

1. General. Supplemental elements may be added to the existing building to bring the structure into conformance with Subsection 18.71.090.B.
2. Seismic loading. The seismic loading shall be calculated by Subsection 18.71.070.B. The loading of each story level shall be calculated by Formula (71-6) of Subsection 18.71.070.D.
3. Relative rigidities. The relative rigidity of reinforced concrete shear walls may be based on the stiffness of uncracked sections. The relative rigidity of infill panels may be calculated using a common modulus of elasticity. Use of a combination of infills and reinforced concrete or masonry shear walls on any orthogonal axis is prohibited.
4. Required calculations. The calculations may be limited to computation of loads on the reinforced concrete shear walls or infilled frame panels that comply with Subsection 18.71.080.B and computation of the drag and tie forces that develop a complete load path. The loads shall include torsional effects.

D. Required strength of systems and elements.

1. The capacity of all parts of the structure shall exceed the demand calculated by use of the loading specified in Section 18.71.070.
2. The strength of infilled frame systems used for lateral load resistance in this section shall be calculated using only the infilled frames that conform to Subsection 18.71.080.B.1.

E. Shear stress limit.

1. The maximum horizontal shear stress in new and existing reinforced concrete shear walls shall not exceed two $(f_c)^{1/2}$. For the purpose of this chapter, the horizontal shear stress may be taken as eighty (80) psi without testing as required by Subsection 18.71.060.F.1.
2. The in-plane shear stress in any masonry infilled panel shall not exceed thirty (30) psi. The calculation of shear stresses shall use net section area and only the area of the infilled masonry.

EXCEPTION: The in-plane strength of an infill panel without openings may be calculated by procedures described in published research that were verified by experimental testing and approved by the Building Official.

18.71.090 – Minimum requirements for a limited structural analysis

- A. General. Structures conforming to the requirements of this section may be shown to be in conformance with this chapter by submission of the report described in this section.
- B. Required features of the building. The building shall conform to all of the following features or the building shall be analyzed as prescribed by Subsection 18.71.050.D.
 1. The lateral-load-resisting elements of the building shall be reinforced concrete shear walls.

2. The minimum ratio of area of reinforcement to gross area of the wall shall be 0.0015 in both the vertical and horizontal directions.
3. The reinforced concrete elements shall have no visible deterioration of concrete or reinforcement.
4. The area of concrete shear walls on each orthogonal axis at the first floor level shall be 1.5% of the area of the first floor of the building, where n is the number of floor and roof levels.
5. The area of the shear walls in all stories above the first floor shall not be more than one hundred percent (100%) or less than eighty percent (80%) of the area of shear walls at the first floor.
6. The concrete shear walls in all stories above the first floor shall be directly above the shear walls at the first floor which are used to calculate the percent of shear wall area to floor area.
7. The wall area must be uniformly distributed such that at least eighty percent (80%) of the wall area used in the calculation is symmetrically placed about the center of the building.
8. The area of the shear walls on each orthogonal axis shall be calculated by passing a horizontal plane through the first story level. The height of the plane shall be that height where the area of the shear walls is a minimum.
9. The ratio of total height to base width of cantilevered or coupled shear walls shall be two (2) or less. The ratio of the clear height to in-plane depth of piers in a shear wall shall be two (2) or less. Shear walls or piers having a height to depth ratio greater than two (2) shall be given an effective area of one-half (1/2) of their area.

C. Information required in the report.

1. The report shall include data, sketches, plans and calculations that show conformance with the features given in this section.
2. The registered design professional of record shall meet with the representative of the Department at the site to review the report.

18.71.100 – Determination of the stress-strain relationship of existing unreinforced masonry.

- A. Scope. This section covers procedures for determining the expected compressive modulus, peak strain and peak compressive stress of unreinforced brick masonry used for infills in frame buildings.
- B. General procedure. The outer wythe of multiple wythe brick masonry shall be tested by inserting two (2) flat jacks into the mortar joints of the outer wythe. The prism height, the vertical distance between the flat jacks, shall be five (5) bricks high. The test location shall have adequate overburden and/or vertical confinement to resist the flat jack forces.
- C. Preparation for the test. Remove a mortar joint at the top and bottom of the test prism by saw cutting or drilling and grinding to a smooth surface. The cuts for inserting the flat jacks shall not have a deviation from parallel of more than three-eighths (3/8) inch. The deviation from parallel shall be measured at the ends of the flat jacks. The width of the saw cut shall not exceed the width of the mortar joint. The length of the saw cut on the face of the wall may exceed the length of the flat jacks by not more than twice the thickness of the outer wythe plus one (1) inch.
- D. Required equipment. The flat jacks shall be rectangular or with semicircular ends to mimic the radius of the saw blade used to cut the slot for the flat jack. The length of the flat jack shall be eighteen (18) inches maximum and sixteen (16) inches minimum. This length shall be measured

on the longest edge of a flat jack with semicircular ends. The maximum width of the flat jack shall not exceed the average width of the wythe of brick that is loaded. The minimum width of a flat jack shall be three and one-half (3-1/2) inches measured out-to-out of the flat jack. The flat jack shall have a minimum of two (2) ports to allow air in the flat jack to be replaced by hydraulic fluid. The unused port shall be sealed after all the air is forced out of the flat jack. The thickness of the flat jack shall not exceed three quarters (3/4) of the minimum height of the mortar joint. It is recommended that the height of the flat jack be about one-half (1/2) of the width of the slot cut for installation of the flat jack. The remaining space can be filled with steel shim plates having plan dimensions equal to the flat jack.

- E. Data acquisition equipment. The strain in the tested prism shall be recorded by gages or similar recording equipment having a minimum range of one ten-thousandth (1/10,000) of an inch. The compressive strain shall be measured on the surface of the prism and shall have a gage length, measured vertically on the face of the prism, of ten (10) inches minimum. The gage points shall be fixed to the wall by drilled-in anchors or by anchors set in epoxy or similar material. The support for the data-recording apparatus shall be isolated from the wall by a minimum of one-sixteenth (1/16) inch so that the gage length used in the calculation of strain can be taken as the measured length between the anchors of the equipment supports. The gaging equipment shall be as close to the face of the prism as possible to minimize the probability of erroneous strain measurements caused by bulging of the prism outward from its original plane.

The compressive strain data shall be measured at a minimum of two (2) points on the vertical face of the prism. These points shall be the one-third points of the length of the flat jacks plus or minus one-half (1/2) inch. As an alternative, the strain may be measured at three (3) points on the face of the prism.

These points shall be spaced at one quarter of the flat jack length plus or minus one-half (1/2) inch.

Horizontal gages at mid-height of the prism may be used to record Poisson strain, but this gage should be considered as recording data secondary in importance to the vertical gages and its placement shall not interfere with placing the vertical gaging as close as possible to the face of the prism.

- F. Loading and recording data. The loading shall be applied by hydraulic pumps that add hydraulic fluid to the flat jacks in a controlled method. The application of load shall be incremental and held constant while strains are being recorded. The increasing loading for each cycle of loading shall be divided into a minimum of four (4) equal load increments. The strain shall be recorded at each load step. The decrease in loading shall be divided into a minimum of two (2) equal unloading increments. Strain shall be recorded on the decreasing load steps. The hydraulic pressure shall be reduced to zero and the permanent strain caused by this cycle of loading shall be recorded. This procedure shall be used for each cycle of loading.

The load applied in each cycle of load shall be determined by estimating the peak compressive stress of the existing brick masonry. The hydraulic pressure needed to cause this peak compressive stress in the prism shall be calculated by assuming the area of the loaded prism is equal to the area of the flat jack. A maximum of one-third (1/3) of this pressure, rounded to the nearest twenty-five (25) psi, shall be applied in the specified increments to the peak pressure prescribed for the first cycle of loading. After recording the strain data, this pressure shall be reduced in a controlled manner to each of the specified increments for unloading and for recording data. The maximum jack pressure on the subsequent cycles shall be one-half (1/2), two-thirds (2/3), five-sixths (5/6) and estimated peak pressure. If the estimated peak compressive stress is less than the existing peak compressive stress, the cyclic loading and unloading shall continue using increments of increasing pressure equal to those used prior to the application of estimated peak pressure.

All strain data shall be recorded to one ten-thousandth (1/10,000) of an inch. Jack pressure shall be recorded in increments of twenty-five (25) psi pressure.

- G. Quality control. The flat jack shall be calibrated before use by placing the flat jack between bearing plates of two (2) inches minimum thickness in a calibrated testing machine. A calibration curve to convert hydraulic pressure in the flat jack to total load shall be prepared and included in the report of the results of testing. Flat jacks shall be recalibrated after three uses.

The hydraulic pressure in the flat jacks shall be indicated by a calibrated dial indicator having a subdivision of twenty-five (25) psi or less. The operator of the hydraulic pump shall use this dial indicator to control the required increments of hydraulic pressure in loading and unloading.

- H. Interpretation of the data. The data obtained from the testing required by Subsection 18.71.060.F.4.b shall be averaged both in expected peak compressive stress and the corresponding peak strain. The envelope of the averaged stress-strain relationship of all tests shall be used for the material model of the masonry in the infilled frame. If two (2) strain measurements have been made on the surface of the prism, these strain measurements shall be averaged for determination of the stress-strain relationship for the test. If three (3) strain measurements have been made on the surface of the prism, the data recorded by the center gage shall be given a weight of two (2) for preparing the average stress-strain relationship for the test.

18.71.110 – Evaluation of existing structural conditions.

The registered design professional of record shall report any observed structural conditions and structural damage that, in the registered design professional's judgment, have imminent life-safety effects on the structure and recommend repairs. Evaluations and repairs shall be reviewed and approved by the Department.

18.71.120 – Materials of construction.

- A. General. In addition to the seismic analysis required elsewhere in this chapter, the registered design professional responsible for the seismic analysis of the building shall record the information required by this section on the approved construction documents.
- B. Information required. The construction documents shall accurately reflect the results of the engineering investigation and design, and show all pertinent dimensions and sizes for plan review and construction. The following shall be provided:
1. The construction documents of the existing construction shall be adequately dimensioned and furnish adequate details in schedules, notes and sections to fully describe the existing building. The construction documents shall include a foundation plan, floor and roof plans which indicate new work, and existing construction;
 2. Elevations of the structural system showing sizes and dimensions;
 3. Schedules, sections and details showing reinforcement of walls, slabs, beams, joists, girders, columns and foundations.

EXCEPTION: If copies of the original construction documents are submitted for information during the plan check, the information required by Subsections 18.71.120.B.1 through 18.71.120.B.3 may be limited to areas of and adjacent to new construction on a complete outline at that level of the building;

4. Sections and details showing attachments and joining of new and existing structures. All reinforcement in the existing structure shall be shown in these sections and details;

5. Specifications and/or general notes fully describing demolition, materials and methods, testing and inspection requirements.
- C. Registered design professional of record's statement. The responsible registered design professional of record shall state on the approved construction documents the following:
1. "I am responsible for this building's seismic strengthening design in compliance with the minimum seismic resistance standards of Chapter 18.71 of the Long Beach Municipal Code."
- or when applicable:
2. "The registered special inspector, required as a condition of the use of structural design stresses requiring continuous inspection, will be responsible to me as required by Section 1704.1 of the California Building Code adopted in Chapter 18.40."

TABLE 71-A RATING CLASSIFICATIONS CLASSIFICATION TYPE OF BUILDING

CLASSIFICATION	TYPE OF BUILDING
Group I	Essential buildings
Group II	Buildings with occupant load of 5,000 or more, or assembly rooms of 1,000 occupants or more, and malls as defined elsewhere in the code.
Group III	1,000 to 4,999 occupants
Group IV	300 to 999 occupants
Group V	All others

TABLE 71-B INITIAL EFFECTIVE MOMENT OF INERTIA OF CONCRETE MEMBERS

MEMBER	RANGE
Rectangular beams	$0.30 - 0.5 I_g$
T- and L-shaped beams	$0.25 - 0.45 I_g$
Columns $P > 0.5 f_c' A_g$	$0.7 - 0.9 I_g$
Columns $P = 0.2 f_c' A_g$	$0.5 - 0.7 I_g$
Columns $P = - 0.05 f_c' A_g$	$0.3 - 0.5 I_g$

TABLE 71-C ASSUMED YIELD STRESS OF EXISTING REINFORCEMENT

TYPE OF REINFORCEMENT AND ERA	ASSUMED YIELD STRESS, ksi
Pre-1940 — Structural and intermediate grade, plain and deformed	45
Pre-1940 — Twisted and hard grade	55
Post-1940 — Structural and intermediate grade	45
Post-1940 — Hard grade	60
ASTM A 615 Grade 40	50
ASTM A 615 Grade 60	70

For SI: 1 ksi = 6.894 MPa.

FIGURE 71-1 RESPONSE SPECTRA SHAPES

AVE. RETURN PERIOD= 475 YEARS DAMPING RATIO= 5%

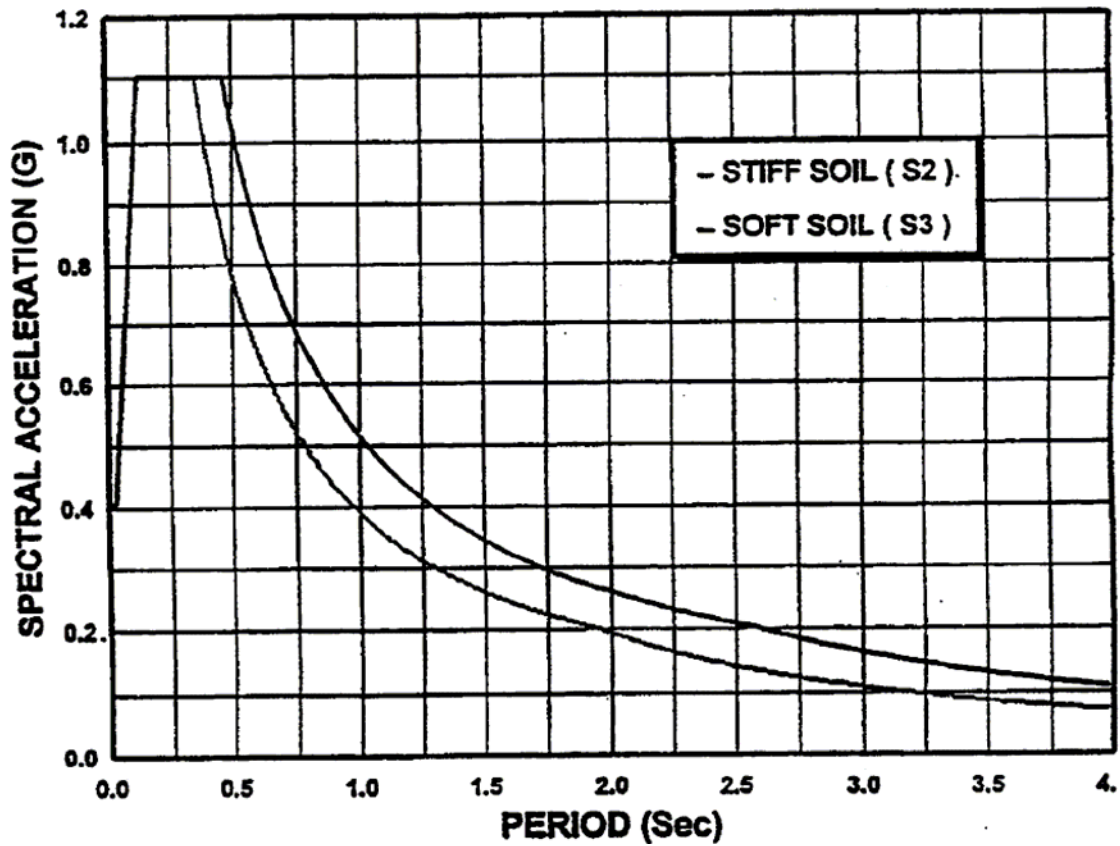

CHAPTER 18.72 VOLUNTARY EARTHQUAKE HAZARD REDUCTIOIN IN EXISTING REINFORCED CONCRETE AND REINFORCED MASONRY WALL BUILDINGS WITH FLEXIBLE DIAPHRAGMS

- 18.72.010 – Purpose.
- 18.72.020 – Scope.
- 18.72.030 – Definitions.
- 18.72.040 – Analysis and design.
- 18.72.050 – Materials of construction.
- 18.72.060 – Information required on construction documents.

CHAPTER 18.72

VOLUNTARY EARTHQUAKE HAZARD REDUCTION IN EXISTING REINFORCED CONCRETE AND REINFORCED MASONRY WALL BUILDINGS WITH FLEXIBLE DIAPHRAGMS

18.72.010 – Purpose.

The purpose of this chapter is to promote public safety and welfare by reducing the risk of death or injury that may result from the effects of earthquakes on reinforced concrete and masonry wall buildings with flexible diaphragms designed under the Building Codes in effect prior to January 1, 1995. These buildings are potentially hazardous and prone to significant damage, including possible collapse, in a moderate to major earthquake. These structures typically shelter large numbers of persons and property for retail, food markets, food distribution centers, warehousing, aerospace, industrial/manufacturing and general business and office use. Their continued use after an earthquake is also essential to the local economy and its post-earthquake recovery.

The provisions of this chapter are minimum standards for structural seismic resistance established primarily to reduce the risk of loss of life or injury on both subject and adjacent properties and will not necessarily prevent all earthquake damage to an existing building which complies with these standards. This chapter shall not require existing electrical, plumbing, mechanical or fire safety systems to be altered unless they constitute a hazard to life or property.

This chapter provides voluntary retrofit standards for deficient wall anchorage systems on structures that are not subject to the mandatory provisions of Chapter 18.68. When fully followed, these standards will strengthen the portion of the structure that is most vulnerable to earthquake damage.

18.72.020 – Scope.

The voluntary provisions of this chapter shall apply to existing buildings of the following types:

- A. Cast-in-place reinforced concrete or masonry wall buildings with flexible diaphragms designed under Building Codes in effect prior to January 1, 1995.
- B. Tilt-up concrete wall buildings with flexible diaphragms designed under the Building Codes in effect prior to January 1, 1995, but after January 1, 1976. All existing reinforced masonry or concrete buildings with flexible diaphragms, including tilt-up concrete wall buildings, designed under the Building Code in effect on or after January 1, 1995, shall be designed in conformance with Chapter 16 of the California Building Code adopted in Chapter 18.40.

18.72.030 – Definitions.

For the purposes of this chapter, the applicable definitions in Chapter 2, Sections 1602, 1613.2, 1902, and 2302 of the California Building Code adopted in Chapter 18.40; Sections 1.2, 3.1.1, 4.1, 5.2, 6.2 and 11.2 of ASCE 7-05, and the following shall apply.

"Anchorage system" means the system of all structural elements and connections which support the concrete or masonry wall in the lateral direction, including diaphragms and subdiaphragms, wall anchorage and continuity or crosstie connectors in subdiaphragms and main diaphragms.

"Commenced construction" means construction pursuant to a valid building permit that has progressed to the point that one of the called inspections as required by the Department has been made and the work for which the inspection has been called has been judged by the Department to be substantial and has been approved by the Department.

"Existing building" means an erected building for which a legal building permit and a Certificate of Occupancy have been issued.

"Flexible diaphragm" means any diaphragm constructed of wood structural panel, diagonal or straight wood sheathing, metal decking without a structural concrete topping, or horizontal rod bracing.

"Historical building" means any building designated or currently in the process of being designated as a historical building by an appropriate federal, State or City jurisdiction.

"Reinforced concrete wall" means a concrete wall which has fifty percent (50%) or more of the reinforcing steel required for reinforced concrete in Chapter 19 of the California Building Code adopted in Chapter 18.40.

"Reinforced masonry wall" means a masonry wall which has fifty percent (50%) or more of the reinforcing steel required by Section 2106.5 of the California Building Code adopted in Chapter 18.40.

"Retrofit" strengthens or structurally improves the lateral force-resisting system of an existing building by alteration of existing or addition of new structural elements.

"Tilt-up concrete wall" is a form of precast concrete panel construction either cast in the horizontal position at the site and after curing, lifted and moved into place in a vertical position, or cast off-site in a fabricator's shop.

18.72.040 – Analysis and design.

- A. Wall panel anchorage. Concrete and masonry walls shall be anchored to all floors and roofs which provide lateral support for the wall. The anchorage shall provide a positive direct connection between the wall and floor or roof construction capable of resisting a horizontal force equal to thirty percent (30%) of the tributary wall weight for all buildings, and forty-five percent (45%) of the tributary wall weight for essential buildings, or a minimum force of two hundred fifty (250) pounds per linear foot of wall, whichever is greater.

The required anchorage shall be based on the tributary wall panel assuming simple supports at floors and roof.

EXCEPTION: An alternate design may be approved by the Building Official when justified by well-established principles of mechanics.

- B. Special requirements for wall anchors and continuity ties. The steel elements of the wall anchorage systems and continuity ties shall be designed by the allowable stress design method using a load factor of 1.7. The one-third (1/3) stress increase permitted by Section 1605.3.2 of the California Building Code adopted in Chapter 18.40 shall not be permitted for materials using allowable stress design methods.

The strength design specified in Section 1912 of the California Building Code adopted in Chapter 18.40, using a load factor of 2.0 in lieu of 1.4 for earthquake loading, shall be used for the design of embedment in concrete.

Wall anchors shall be provided to resist out-of-plane forces, independent of existing shear anchors.

EXCEPTION: Existing cast-in-place shear anchors may be used as wall anchors if the tie element can be readily attached to the anchors and if the registered design professional can establish tension values for the existing anchors through the use of approved as-built plans or testing, and through analysis showing that the bolts are capable of resisting the total shear load while being acted upon by the maximum tension force due to seismic loading. Criteria for analysis and testing shall be determined by the Building Official.

Expansion anchors are not allowed without special approval of the Building Official. Attaching the edge of plywood sheathing to steel ledgers is not considered as complying with the positive

anchoring requirements of the code; and attaching the edge of steel decks to steel ledgers is not considered as providing the positive anchorage of this code unless testing and analysis are performed which establish shear values for the attachment perpendicular to the edge of the deck.

- C. Development of anchor loads into the diaphragm. Development of anchor loads into roof and floor diaphragms shall comply with Section 12.11.2.2.3 of ASCE 7-05.

EXCEPTION: If continuously tied girders are present, then the maximum spacing of the continuity ties is the greater of the girder spacing or twenty-four (24) feet.

In wood diaphragms, anchorage shall not be accomplished by use of toenails or nails subject to withdrawal, nor shall wood ledgers, top plates or framing be used in cross-grain bending or cross grain tension. The continuous ties required by Section 12.11.2.2.3 of ASCE 7-05 shall be in addition to the diaphragm sheathing.

Lengths of development of anchor loads in wood diaphragms shall be based on existing field nailing of the sheathing unless existing edge nailing is positively identified on the original construction plans or at the site.

At reentrant corners, continuity collectors may be required for existing return walls not designed as shear walls, to develop into the diaphragm a force equal to the lesser of the rocking or shear capacity of the return wall, or the tributary shear but not exceeding the capacity of the diaphragm. Shear anchors for the return wall shall be commensurate with the collector force. If a truss or beam other than rafters or purlins is supported by the return wall or by a column integral with the return wall, an independent secondary column is required to support the roof or floor members whenever rocking or shear capacity of the return wall is governing.

- D. Anchorage at pilasters. Anchorage of pilasters shall be designed for the tributary wall anchoring load per Subsection 18.72.040.A, considering the wall as a two-way slab. The edge of the two-way slab shall be considered "fixed" when there is continuity at pilasters, and considered "pinned" at roof or floor levels. The pilasters or the walls immediately adjacent to the pilasters shall be anchored directly to the roof framing such that the existing vertical anchor bolts at the top of the pilasters are bypassed without causing tension or shear failure at the top of the pilasters.

EXCEPTION: If existing vertical anchor bolts at the top of the pilasters are used for the anchorage, then additional exterior confinement shall be provided.

The minimum anchorage at a floor or roof between the pilasters shall be that specified in Subsection 18.72.040.A.

- E. Symmetry. Symmetry of connectors in the anchorage system is required. Eccentricity may be allowed when it can be shown that all components of forces are positively resisted and justified by calculations or tests.
- F. Minimum member size. Wood members used to develop anchorage forces to the diaphragm shall be of minimum three-inch nominal width for new construction and replacement. All such members must be designed for gravity and earthquake forces as part of the wall anchorage system. For existing structural members, the allowable stresses shall be without the one-third (1/3) stress increase per Subsection 18.72.040.B.
- G. Combination of anchor types. To repair and retrofit existing buildings, a combination of different anchor types of different behavior or stiffness shall not be permitted. The capacity of the new and existing connectors cannot be added.
- H. Prohibited anchors. Usage of connectors that were bent or stretched from the intended use shall be prohibited.

- I. Crack and damage repairs, evaluation of existing structural alterations. The registered design professional shall report any observed structural conditions and structural damage that have imminent life-safety effects on the buildings and recommend repairs, including alterations such as openings cut in existing wall panels without a building permit. Evaluations and repairs shall be reviewed and approved by the Department.
- J. Miscellaneous. Existing mezzanines relying on the concrete or masonry walls for vertical or lateral support shall be anchored to the walls for the tributary mezzanine load. Walls depending on the mezzanine for lateral support shall be anchored per Subsections 18.72.040.A through 18.72.040.C.

EXCEPTION: Existing mezzanines that have independent lateral and vertical support need not be anchored to the concrete or masonry walls.

Existing interior masonry or concrete walls not designed as shear walls, which extend to the floor above or to the roof diaphragm, shall also be anchored for out-of-plane forces per Subsections 18.72.040.A through 18.72.040.C. In the in-plane direction, the walls may be isolated or shall be developed into the diaphragm for a lateral force equal to the lesser of the rocking or shear capacity of the wall, or the tributary shear but not exceeding the diaphragm capacity.

- K. Historical buildings. Qualified historical buildings shall be permitted to use alternate building standards or deviations from this chapter in order to preserve their original or restored architectural elements and features. See California Code of Regulations, Title 24, Part 8 (California Historical Building Code) for these standards

18.72.050 – Materials of construction.

All materials permitted by this title, including their appropriate allowable stresses and those existing configurations of materials specified in Chapter 18.68, may be utilized to meet the requirements of this chapter.

18.72.60 – Information required on construction documents.

- A. General. In addition to the seismic analysis required elsewhere in this chapter, the licensed registered design professional responsible for the seismic analysis of the building shall record the information required by this section on the approved construction documents.
- B. Information required. The construction documents shall accurately reflect the results of the engineering investigation and design and show all pertinent dimensions and sizes for plan review and construction. The following shall be provided:
 - 1. Floor plans and roof plans shall show the existing framing construction, diaphragm construction, proposed wall anchors, crossties and collectors. Existing nailing, anchors, ties and collectors shall also be shown on the plans if these are part of the design, and these structural elements need to be verified in the field.
 - 2. At elevations where there is alterations or damage, the details shall show the roof and floor heights, dimensions of openings, location and extent of existing damage, and proposed repair.
 - 3. Typical concrete or masonry wall sections with wall thickness, height and location of anchors shall be provided.
 - 4. Details shall include the existing and new anchors and the method of development of anchor forces into the diaphragm framing, existing and new crossties, existing and new or improved support of the roof, and floor girders at pilasters or walls.

C. Registered design professional of record's statement. The responsible registered design professional of record shall state on the approved construction documents the following:

1. "I am responsible for this building's seismic strengthening design of the tilt-up concrete wall anchorage system in compliance with the minimum seismic resistance standards of Chapter 18.72 of the Long Beach Municipal Code."

or when applicable:

2. "The Registered Special Inspector, required as a condition of the use of structural design stresses requiring continuous inspection, will be responsible to me as required by Section 1704.1 of the California Building Code adopted in Chapter 18.40."

CHAPTER 18.73 FLOOD RESISTANT DESIGN AND CONSTRUCTION

- 18.73.010 – Findings of fact.
- 18.73.020 – Statement of purpose.
- 18.73.030 – Methods of reducing flood losses.
- 18.73.040 – Definitions.
- 18.73.050 – Lands to which this Ordinance applies.
- 18.73.060 – Basis for establishing the areas of special flood hazard.
- 18.73.070 – Compliance.
- 18.73.080 – Abrogations and greater restrictions.
- 18.73.090 – Interpretation.
- 18.73.100 – Warning and disclaimer of liability.
- 18.73.110 – Severability.
- 18.73.120 – Establishment of development permit.
- 18.73.130 – Designation of the local administrator.
- 18.73.140 – Duties and responsibilities of the Floodplain Administrator.
- 18.73.150 – Permit review.
- 18.73.160 – Use of other base flood data.
- 18.73.170 – AR Zone duties of the Floodplain Administrator.
- 18.73.180 – Notification of other agencies.
- 18.73.190 – Information to be obtained and maintained.
- 18.73.200 – Interpretation of FIRM boundaries.
- 18.73.210 – Remedial action.
- 18.73.220 – Appeals.
- 18.73.230 – Standards of construction.
- 18.73.240 – Standards for utilities.
- 18.73.250 – Standards for subdivisions.
- 18.73.260 – Standards for manufactured homes and manufactured home parks and subdivisions.
- 18.73.270 – Standards for recreational vehicles.
- 18.73.280 – Floodways.
- 18.73.290 – Construction standards for AR Zone areas.
- 18.73.300 – Coastal high hazard area.
- 18.73.310 – Nature of variances.
- 18.73.320 – Variance procedure.
- 18.73.330 – Conditions for variances.
- 18.73.340 – Alternative Compliance.

CHAPTER 18.73 FLOOD RESISTANT DESIGN AND CONSTRUCTION

18.73.010 – Findings of fact.

The City of Long Beach finds:

- A. The flood hazard areas of the City of Long Beach are subject to periodic inundation which results in loss of life and property; creation of health and safety hazards; disruption of commerce and governmental services; extraordinary public expenditures for flood protection and relief; and impairment of the tax base, all of which adversely affect public health, safety and general welfare.
- B. These flood losses are caused by uses that are inadequately elevated, floodproofed, or protected from flood damage. The cumulative effect of obstructions in areas of special flood hazards which increase flood heights and velocities also contribute to the flood loss.

18.73.020 – Statement of purpose.

It is the purpose of this chapter to promote the public health, safety and general welfare, and to minimize public and private losses due to flood conditions in specific areas by provisions designed:

- A. To minimize expenditure of public money for costly flood control projects;
- B. To minimize the need for rescue and relief efforts associated with flooding, generally undertaken at the expense of the general public;
- C. To minimize prolonged business interruptions;
- D. To minimize damage to public facilities and utilities such as water and gas mains; electric, telephone and sewer lines; and streets and bridges located in areas of special flood hazard;
- E. To help maintain a stable tax base by providing for the sound use and development of areas of special flood hazard so as to minimize future blighted areas caused by flood damage;
- F. To ensure that potential buyers are notified that property is in an area of special flood hazard; and
- G. To ensure that those who occupy special flood hazard areas assume responsibility for their actions.

18.73.030 – Methods of reducing flood losses.

In order to accomplish its purposes, this chapter includes methods and provisions for:

- A. Restricting and prohibiting uses which are dangerous to health, safety and property due to water or erosion hazards, or which result in damaging increase in erosion, flood heights or flood velocities;
- B. Requiring that uses vulnerable to floods, including facilities which serve such uses, be protected against flood damage at the time of initial construction;
- C. Controlling the alteration of natural flood plains, stream channels and natural protective barriers which help accommodate or channel flood waters;
- D. Controlling filling, dredging, grading, and other development which may increase flood damage; and

- E. Preventing or regulating the construction of flood barriers which will unnaturally divert flood waters or which may increase flood hazards in other areas.

18.73.040 – Definitions.

Unless specifically defined below, words or phrases used in this chapter shall be interpreted so as to give them the meaning they have in common usage and to give this chapter its most reasonable application. As used in this chapter, the words and phrases listed in this section shall have the meaning given them as follows:

- A. "Accessory use" means a use which is incidental and subordinate to the principal use of the parcel of land on which it is located.
- B. "Alluvial fan" means a geomorphologic feature characterized by a cone or fan-shaped deposit of boulders, gravel, and fine sediments that have been eroded from mountain slopes, transported by flood flows, and then deposited on the valley floors, and which is subject to flash flooding, high velocity flows, debris flows, erosion, sediment movement and deposition, and channel migration.
- C. "Apex" means the point of highest elevation on an alluvial fan, which on undisturbed fans is generally the point where the major stream that formed the fan emerges from the mountain front.
- D. "Appeal" means a request for a review of the Floodplain Administrator's interpretation of any provision of this chapter.
- E. "Area of shallow flooding" means a designated AO, AH, AR/AO or AR/AH Zone on the Flood Insurance Rate Map (FIRM). The base flood depths range from one (1) to three (3) feet; a clearly defined channel does not exist; the path of flooding is unpredictable and indeterminate; and, velocity flow may be evident. Such flooding is characterized by ponding or sheet flow.
- F. "Area of special flood hazard"—see "Special flood hazard area".
- G. "AR Zone" means a special flood hazard area that results from the decertification of a previously accredited flood protection system that is determined to be in the process of being restored to provide a 100-year or greater level of flood protection.
- H. "Base flood" means the flood having a one percent (1%) chance of being equaled or exceeded in any given year (also called the 100-year flood). Base flood is the term used throughout this chapter.
- I. "Basement" means any area of the building having its floor subgrade—i.e., below ground level—on all sides.
- J. "Breakaway walls" means any type of walls, whether solid or lattice, and whether constructed of concrete, masonry, wood, metal, plastic or any other suitable building material which is not part of the structural support of the building and which is designed to break away, under abnormally high tides or wave action, without causing any damage to the structural integrity of the building on which they are used or any buildings to which they might be carried by flood waters. A breakaway wall shall have a safe design loading resistance of not less than ten (10) and no more than twenty (20) pounds per square foot. Use of breakaway walls must be certified by a register design professional licensed in the State of California to practice as such and shall meet the following conditions:
 - 1. Breakaway wall collapse shall result from a water load less than that which would occur during the base flood, and
 - 2. The elevated portion of the building shall not incur any structural damage due to the effects of wind and water loads acting simultaneously in the event of the base flood.

- K. "Building"—see "Structure".
- L. "Coastal high hazard area" means an area of special flood hazard extending from offshore to the inland limit of a primary frontal dune along an open coast and any other area subject to high velocity wave action from storms or seismic sources. It is an area subject to high velocity waters, including coastal and tidal inundation or tsunamis. The area is designated on a Flood Insurance Rate Map (FIRM) as Zone V1-30, VE, or V.
- M. "Development" means any manmade change to improved or unimproved real estate, including, but not limited to, buildings or other structures, mining, dredging, filling, grading, paving, excavation or drilling operations or storage of equipment or materials.
- N. "Developed areas" means an area of a community that is:
1. A primarily urbanized, built-up area that is a minimum of twenty (20) contiguous acres, has basic urban infrastructure, including roads, utilities, communications, and public facilities, to sustain industrial, residential, and commercial activities, and
 - a. Within which seventy-five percent (75%) or more of the parcels, tracts, or lots contain commercial, industrial, or residential structures or uses; or
 - b. Is a single parcel, tract, or lot in which seventy-five percent (75%) of the area contains existing commercial or industrial structures or uses; or
 - c. Is a subdivision developed at a density of at least two (2) residential structures per acre within which seventy-five percent (75%) or more of the lots contain existing residential structures.
 2. Undeveloped parcels, tracts, or lots, the combination of which is less than twenty (20) acres and contiguous on at least three (3) sides to areas meeting the criteria of paragraph 1.
 3. A subdivision that is a minimum of twenty (20) contiguous acres that has obtained all necessary government approvals, provided that the actual "start of construction" of structures has occurred on at least:
 - a. Ten percent (10%) of the lots or remaining lots of a subdivision; or
 - b. Ten percent (10%) of the maximum building coverage or remaining building coverage allowed for a single lot subdivision and construction of structures is underway. Residential subdivisions must meet the density criteria in Subsection 18.73.040.N.1.c.
- O. "Encroachment" means the advance or infringement of uses, plant growth, fill, excavation, buildings, permanent structures or development into a floodplain which may impede or alter the flow capacity of a floodplain.
- P. "Existing manufactured home park or subdivision" means a manufactured home park or subdivision for which the construction of facilities for servicing the lots on which the manufactured homes are to be affixed (including, at a minimum, the installation of utilities, the construction of streets, and either final site grading or the pouring of concrete pads) is completed before September 15, 1983, the effective date of the floodplain management regulations adopted by the City of Long Beach.
- Q. "Expansion to an existing manufactured home park or subdivision" means the preparation of additional sites by the construction of facilities for servicing the lots on which the manufactured homes are to be affixed (including the installation of utilities, the construction of streets, and either final site grading or the pouring of concrete pads).

- R. "Flood, flooding, or flood water" means a general and temporary condition of partial or complete inundation of normally dry land areas from the overflow of inland or tidal waters; the unusual and rapid accumulation or runoff of surface waters from any source.
- S. "Flood Insurance Rate Map (FIRM)" means the official map on which the Federal Emergency Management Agency or Federal Insurance Administration has delineated both the areas of special flood hazards, the floodway and the risk premium zones applicable to the community.
- T. "Flood Insurance Study" means the official report provided by the Federal Insurance Administration that includes flood profiles, the FIRM, and the water surface elevation of the base flood.
- U. "Floodplain or flood-prone area" means any land area susceptible to being inundated by water from any source—see "Flooding".
- V. "Floodplain Administrator" is the individual appointed to administer and enforce the floodplain management regulations.
- W. "Floodplain management" means the operation of an overall program of corrective and preventive measures for reducing flood damage and preserving and enhancing, where possible, natural resources in the floodplain, including but not limited to emergency preparedness plans, flood control works, floodplain management regulations, and open space plans.
- X. "Floodplain management regulations" means this chapter and other zoning ordinances, subdivision regulations, Building Codes, health regulations, special purpose ordinances (such as grading) and other applications of police power which control development in flood-prone areas. This term describes federal, State or local regulations in any combination thereof which provide standards for preventing and reducing flood loss and damage.
- Y. "Floodproofing" means any combination of structural and nonstructural additions, changes, or adjustments to structures which reduce or eliminate flood damage to real estate or improved real property, water and sanitary facilities, structures, and their contents.
- Z. "Floodway" means the channel of a river or other watercourse and the adjacent land areas that must be reserved in order to discharge the base flood without cumulatively increasing the water surface elevation more than one (1) foot. Also referred to as "Regulatory Floodway".
- AA. "Floodway fringe" is that area of the floodplain on either side of the "Regulatory Floodway" where encroachment may be permitted.
- BB. "Fraud and victimization" as related to Section 18.73.310 et seq. of this chapter means that the variance granted must not cause fraud on or victimization of the public. In examining this requirement, the City Council will consider the fact that every newly constructed building adds to government responsibilities and remains a part of the community for fifty (50) to one hundred (100) years. Buildings that are permitted to be constructed below the base flood elevation are subject during all those years to increased risk of damage from floods, while future owners of the property and the community as a whole are subject to all the costs, inconvenience, danger, and suffering that those increased flood damages bring. In addition, future owners may purchase the property, unaware that it is subject to potential flood damage, and can be insured only at very high flood insurance rates.
- CC. "Functionally dependent use" means a use which cannot perform its intended purpose unless it is located or carried out in close proximity to water. The term includes only docking facilities, port facilities that are necessary for the loading and unloading of cargo or passengers, and ship building and ship repair facilities, and does not include long-term storage or related manufacturing facilities.

DD. "Governing body" is the City Council of the City of Long Beach that is empowered to adopt and implement regulations to provide for the public health, safety and general welfare of its citizenry.

EE. "Hardship" as related to Section 18.73.310 et seq. of this chapter means the exceptional hardship that would result from a failure to grant the requested variance. The City of Long Beach requires that the variance be exceptional, unusual, and peculiar to the property involved. Mere economic or financial hardship alone is not exceptional. Inconvenience, aesthetic considerations, physical handicaps, personal preferences, or the disapproval of one's neighbors likewise cannot, as a rule, qualify as an exceptional hardship. All of these problems can be resolved through other means without granting a variance, even if the alternative is more expensive, or requires the property owner to build elsewhere or put the parcel to a different use than originally intended.

FF. "Highest adjacent grade" means the highest natural elevation of the ground surface prior to construction next to the proposed walls of the structure.

GG. "Historic structure" means any structure that is:

1. Listed individually in the National Register of Historic Places (a listing maintained by the Department of Interior) or preliminarily determined by the Secretary of the Interior as meeting the requirements for individual listing on the National Register;
2. Certified or preliminarily determined by the Secretary of the Interior as contributing to the historical significance of a registered historic district or a district preliminarily determined by the Secretary to qualify as a registered historic district;
3. Individually listed on the California State Inventory of Historic Places; or
4. Individually listed on the Long Beach inventory of historic places.

HH. "Levee" means a manmade structure, usually an earthen embankment, designed and constructed in accordance with sound engineering practices to contain, control or divert the flow of water so as to provide protection from temporary flooding.

II. "Levee system" means a flood protection system which consists of a levee, or levees, and associated structures, such as closure and drainage devices, which are constructed and operated in accord with sound engineering practices.

JJ. "Lowest floor" means the lowest floor of the lowest enclosed area, including basement (see "Basement" definition).

1. An unfinished or flood resistant enclosure below the lowest floor that is usable solely for parking of vehicles, building access or storage in an area other than a basement area, is not considered a building's lowest floor provided it conforms to applicable non-elevation design requirements, including, but not limited to:
 - a. The wet floodproofing standards in Subsection 18.73.230.C.4;
 - b. The anchoring standards in Subsection 18.73.230.A;
 - c. The construction materials and methods standards in Subsection 18.73.230.B;
 - d. The standards for utilities in Section 18.73.240.
2. For residential structures, all subgrade enclosed areas are prohibited as they are considered to be basements (see "Basement" definition). This prohibition includes below-grade garages and storage areas.

KK. "Manufactured home" means a structure, transportable in one or more sections, which is built on a permanent chassis and is designed for use with or without a permanent foundation when connected to the required utilities. The term "manufactured home" does not include a "recreational vehicle".

LL. "Manufactured home park or subdivision" means a parcel (or contiguous parcels) of land divided into two (2) or more manufactured home lots for rent or sale.

MM. "Mean sea level" means, for purposes of the National Flood Insurance Program, the National Geodetic Vertical Datum (NGVD) of 1929 or other datum, to which base flood elevations shown on a community's Flood Insurance Rate Map are referenced.

NN. "New construction" for floodplain management purposes, means structures for which the "start of construction" commenced on or after September 15, 1983, the effective date of floodplain management regulations adopted by the City of Long Beach, and includes any subsequent improvements to such structures.

OO. "New manufactured home park or subdivision" means a manufactured home park or subdivision for which the construction of facilities for servicing the lots on which the manufactured homes are to be affixed (including at a minimum, the installation of utilities, the construction of streets, and either final site grading or the pouring of concrete pads) is completed on or after September 15, 1983, the effective date of floodplain management regulations adopted by this community.

PP. "Obstruction" includes, but is not limited to, any dam, wall, wharf, embankment, levee, dike, pile, abutment, protection, excavation, channelization, bridge, conduit, culvert, building, wire, fence, rock, gravel, refuse, fill, structure, vegetation or other material in, along, across or projecting into any watercourse which may alter, impede, retard or change the direction and/or velocity of the flow of water, or due to its location, its propensity to snare or collect debris carried by the flow of water, or its likelihood of being carried downstream.

QQ. "One-hundred-year flood" or "100-year flood"—see "Base flood".

RR. "Primary frontal dune" means a continuous or nearly continuous mound or ridge of sand with relatively steep seaward and landward slopes immediately landward and adjacent to the beach and subject to erosion and overtopping from high tides and waves during major coastal storms. The inland limit of the primary frontal dune occurs at the point where there is a distinct change from a relatively mild slope.

SS. "Public safety and nuisance" as related to Section 18.73.310 et seq. of this chapter means that the granting of a variance must not result in anything which is injurious to safety or health of an entire community or neighborhood, or any considerable number of persons, or unlawfully obstructs the free passage or use, in the customary manner, of any navigable lake, or river, bay, stream, canal, or basin.

TT. "Recreational vehicle" means a vehicle which is:

1. Built on a single chassis;
2. Four hundred (400) square feet or less when measured at the largest horizontal projection;
3. Designed to be self-propelled or permanently towable by a light-duty truck; and
4. Designed primarily not for use as a permanent dwelling but as temporary living quarters for recreational, camping, travel, or seasonal use.

- UU. "Regulatory floodway" means the channel of a river or other watercourse and the adjacent land areas that must be reserved in order to discharge the base flood without cumulatively increasing the water surface elevation more than one (1) foot.
- VV. "Remedy a violation" means to bring the structure or other development into compliance with State or City floodplain management regulations or, if this is not possible, to reduce the impacts of its noncompliance. Ways that impacts may be reduced include protecting the structure or other affected development from flood damages, implementing the enforcement provisions of this chapter or otherwise deterring future similar violations, or reducing State or federal financial exposure with regard to the structure or other development.
- WW. "Riverine" means relating to, formed by, or resembling a river (including tributaries), stream, brook, etc.
- XX. "Sand dunes" means naturally occurring accumulations of sand in ridges or mounds landward of the beach.
- YY. "Sheet flow area" see "Area of shallow flooding".
- ZZ. "Special flood hazard area (SFHA)" means an area in the floodplain subject to a one percent (1%) or greater chance of flooding in any given year. It is shown on a FIRM as Zone A, AO, A1-A30, AE, A99, AR, AR/A1-A30, AR/AE, AR/AO, AR/AH, AR/A, AH, V1-V30, VE or V.
- AB. "Start of construction" includes substantial improvement and other proposed new development and means the date the building permit was issued, provided the actual start of construction, repair, reconstruction, rehabilitation, addition, placement, or other improvement was within one hundred eighty (180) days from the date of the permit. The actual start means either the first placement of permanent construction of a structure on a site, such as the pouring of slab or footings, the installation of piles, the construction of columns, or any work beyond the stage of excavation; or the placement of a manufactured home on a foundation. Permanent construction does not include land preparation, such as clearing, grading, and filling; nor does it include the installation of streets and/or walkways; nor does it include excavation for a basement, footings, piers, or foundations or the erection of temporary forms; nor does it include the installation on the property of accessory buildings, such as garages or sheds not occupied as dwelling units or not part of the main structure. For a substantial improvement, the actual start of construction means the first alteration of any wall, ceiling, floor, or other structural part of a building, whether or not that alteration affects the external dimensions of the building.
- AC. "Structure" means a walled and roofed building that is principally above ground; this includes a gas or liquid storage tank or a manufactured home.
- AD. "Substantial damage" means damage of any origin sustained by a structure whereby the cost of restoring the structure to its before damaged condition would equal or exceed fifty percent (50%) of the market value of the structure before the damage occurred.
- AE. "Substantial improvement" means any reconstruction, rehabilitation, addition, or other proposed new development of a structure, the cost of which equals or exceeds fifty percent (50%) of the market value of the structure before the "start of construction" of the improvement. This term includes structures which have incurred "substantial damage", regardless of the actual repair work performed. The term does not, however, include either:
1. Any project for improvement of a structure to correct existing violations or State or local health, sanitary, or safety code specifications which have been identified by a local code enforcement official and which are the minimum necessary to assure safe living conditions, or
 2. Any alteration of a "historic structure", provided that the alteration will not preclude the structure's continued designation as a "historic structure".

AF. "V zone"—see "Coastal high hazard area".

AG. "Variance" means a grant of relief from the requirements of this chapter which permits construction in a manner that would otherwise be prohibited by this chapter.

AH. "Violation" means the failure of a structure or other development to be fully compliant with this chapter. A structure or other development without the elevation certificate, other certifications, or other evidence of compliance required in this chapter is presumed to be in violation until such time as that documentation is provided.

AI. "Water surface elevation" means the height, in relation to the National Geodetic Vertical Datum (NGVD) of 1929, (or other datum, where specified) of floods of various magnitudes and frequencies in the floodplains of coastal or riverine areas.

AJ. "Watercourse" means a lake, river, creek, stream, wash, arroyo, channel or other topographic feature on or over which waters flow at least periodically. Watercourse includes specifically designated areas in which substantial flood damage may occur.

18.73.050 – Lands to which this ordinance applies.

This chapter shall apply to all areas of special flood hazards within the jurisdiction of the City of Long Beach.

18.73.060 – Basis for establishing the areas of special flood hazard.

The areas of special flood hazard identified by the Federal Insurance Administration (FIA), of the Federal Emergency Management Agency (FEMA), in a scientific and engineering report entitled "The Flood Insurance Study for the City of Long Beach", dated July 6, 1998, with accompanying Flood Insurance Rate Map (FIRMs), and all subsequent amendments and/or revisions, are hereby adopted by reference and declared to be a part of this chapter. This flood insurance study and attendant mapping is the minimum area of applicability of this chapter and may be supplemented by studies for other areas which allow implementation of this chapter and which are recommended to the City Council by the Floodplain Administrator. The Flood Insurance Study and FIRMs are on file in the office of the Department of Public Works, 333 West Ocean Boulevard, Long Beach, California 90802.

18.73.070 – Compliance.

No structure or land shall hereafter be constructed, located, extended, converted or altered without full compliance with the terms of this chapter and other applicable regulations. Violation of the requirements (including violations of conditions and safeguards established in connection with conditions) shall constitute a misdemeanor. Nothing herein shall prevent the City of Long Beach from taking such lawful action as is necessary to prevent or remedy any violations.

18.73.080 – Abrogations and greater restrictions.

This chapter is not intended to repeal, abrogate or impair any existing easements, covenants or deed restrictions. However, where this chapter and another ordinance, easement, covenant or deed restriction conflict or overlap, whichever imposes the more stringent restrictions shall prevail.

18.73.090 – Interpretation.

In the interpretation and application of this chapter, all provisions shall be:

- A. Considered as minimum requirements;
- B. Liberally construed in favor of the government body; and

C. Deemed neither to limit nor repeal any other powers lawfully granted.

18.73.100 – Warning and disclaimer of liability.

The degree of flood protection required by this chapter is considered reasonable for regulatory purposes and is based on scientific and engineering considerations. Larger floods can and will occur on occasion. Flood heights may be increased by manmade or natural causes. This chapter does not imply that land outside areas of special flood hazards or uses permitted within such areas will be free from flooding or flood damages. This chapter shall not create liability on the part of the City of Long Beach, any officer or employee thereof, the State of California, the Federal Insurance Administration, or the Federal Emergency Management Agency, for any flood damages that result from reliance on this chapter or any administrative decision made hereunder.

18.73.110 – Severability.

This chapter and the various parts thereof are hereby declared to be severable. Should any section of this chapter be declared by the courts to be unconstitutional or invalid, such decision shall not affect the validity of this chapter as a whole, or any portion thereof other than the section so declared to be unconstitutional or invalid.

18.73.120 – Establishment of development permit.

A development permit shall be obtained before any construction or other development begins within any area of special flood hazard established in Section 18.73.060. Application for a development permit shall be made on forms furnished by the Floodplain Administrator and may include, but not be limited to: plans in duplicate drawn to scale showing the nature, location, dimensions, and elevation of the area in question; existing or proposed structures, fill, storage of materials, drainage facilities; and the location of the foregoing. Specifically, the following information is required:

- A. Proposed elevation in relation to mean sea level, of the lowest floor, including basements, of all structures—in Zone AO, elevation of highest adjacent grade and proposed elevation of lowest floor of all structures; or
- B. Proposed elevation in relation to mean sea level to which any nonresidential structure will be floodproofed, if required in Subsection 18.73.230.C.4; and
- C. All appropriate certifications listed in Section 18.73.190; and
- D. Description of the extent to which any watercourse will be altered or relocated as a result of proposed development.

18.73.130 – Designation of the local administrator.

The City Manager or his designated representative is hereby appointed Floodplain Administrator to administer and implement this chapter by granting or denying development permits in accordance with its provisions.

18.73.140 – Duties and responsibilities of the Floodplain Administrator.

The duties of the Floodplain Administrator shall include but not be limited to the duties set forth in Sections 18.73.150 through 18.73.210.

18.73.150 – Permit review.

The Floodplain Administrator shall:

- A. Review all development permits to determine that the permit requirements of this chapter have been satisfied;
- B. Review all development permits to determine that the proposed development does not adversely affect the carrying capacity of areas where base flood elevations have been determined, but a floodway has not been designated. For purposes of this chapter, "adversely affects" means that the cumulative effect of the proposed development when combined with all other existing and anticipated development will increase the water surface elevation of the base flood more than one (1) foot at any point;
- C. Review proposed development to assure that all required State and federal permits have been obtained;
- D. Review all development permits to determine that the site is reasonably safe from flooding.

18.73.150 – Use of other base flood data.

When base flood elevation data has not been provided in accordance with Section 18.73.060, the Floodplain Administrator shall obtain, review and reasonably utilize any base flood elevation data available from a federal, State or other source, in order to administer Section 18.73.230. Any such information shall be submitted to the City Council for adoption.

18.73.170 – AR Zone duties of the floodplain administrator.

The Floodplain Administrator shall:

- A. Use the adopted official map or legal description of those designated developed areas within Zones AR, AR/A1-30, AR/AE, AR/AH, AR/A, AR/AO as defined in Section 18.73.040 to determine if a proposed project is in a developed area.
- B. Determine the base flood elevation to be used for individual projects within the developed areas, areas not designated as developed areas, and dual zone areas (see Section 18.73.290).
- C. Require the applicable standards in Section 18.73.230.
- D. Provide written notification to the permit applicant that the area has been designated as an AR, AR/A1-30, AR/AE, AR/AH, AR/AO, or AR/A Zone and whether the structure will be elevated or protected to or above the AR base flood elevation.

18.73.180 – Notification of other agencies.

Where there is an alteration or relocation of a watercourse, the Floodplain Administrator shall:

- A. Notify adjacent communities and the California Department of Water Resources prior to the alteration or relocation;
- B. Submit evidence of such notification to the Federal Insurance Administration, Federal Emergency Management Agency; and
- C. Assure that the flood carrying capacity within the altered or relocated portion of said watercourse is maintained.

18.73.190 – Information to be obtained and maintained.

The Floodplain Administrator shall obtain and maintain for public inspection and shall make available as needed for flood insurance policies:

- A. Certification required by Subsection 18.73.230.C.2 (lowest floor elevations);
- B. Certification required by Subsection 18.73.230.C.3 (elevation or floodproofing of nonresidential structures);
- C. Certification required by Subsection 18.73.230.C.4 (wet floodproofing standard);
- D. Certification of elevation required by Subsection 18.73.250.B (subdivision standards);
- E. Certification required by Subsection 18.73.280.A (floodway encroachments); and
- F. Information required by Section 18.73.300 (coastal construction standards).

18.73.200 – Interpretation of FIRM boundaries.

The Floodplain Administrator shall make interpretations where needed as to the exact location of the boundaries of areas of special flood hazards, for example, where there appears to be a conflict between a mapped boundary and actual field conditions. The person contesting the boundaries shall be given a reasonable opportunity to appeal the interpretation as provided for in Sections 18.73.310, 18.73.320 and 18.73.330.

18.73.210 – Remedial action.

The Floodplain Administrator shall take action to remedy violations of this chapter as specified in Section 18.73.070.

18.73.220 – Appeals.

The City Council shall hear and decide appeals when it is alleged there is an error in any requirement, decision, or determination made by the Floodplain Administrator in the enforcement or administration of this chapter.

18.73.230 – Standards of construction.

In all areas of special flood hazard, the following standards are required:

- A. Anchoring.
 - 1. All new construction and substantial improvements shall be adequately anchored to prevent flotation, collapse or lateral movement of the structure resulting from hydrodynamic and hydrostatic loads, including the effects of buoyancy.
 - 2. All manufactured homes shall meet the anchoring standards of Section 18.73.260.
- B. Construction materials and methods.
 - 1. All new construction and substantial improvements shall be constructed with materials and utility equipment resistant to flood damage.
 - 2. All new construction and substantial improvements shall use methods and practices that minimize flood damage.
 - 3. Electrical, heating, ventilation, plumbing, and air-conditioning equipment and other service facilities shall be designed and/or located so as to prevent water from entering or accumulating within the components during conditions of flooding.

4. If within Zones AH, AO, AR/AH, or AR/AO, there shall be adequate drainage paths around structures on slopes to guide flood waters around and away from the proposed structures.
- C. Elevation and floodproofing. (See definitions for "basement", "lowest floor", "new construction", "substantial damage" and "substantial improvement").
 1. For AR Zone requirements, see Section 18.73.290;
 2. Residential construction, new or substantial improvement, shall have the lowest floor, including basement:
 - a. In an AO Zone, elevated above the highest adjacent grade to a height equal to or exceeding the depth number specified in feet on the FIRM, or elevated at least two (2) feet above the highest adjacent grade if no depth number is specified.
 - b. In an A Zone, elevated to or above the base flood elevation, as determined by the City.
 - c. In all other zones, elevated to or above the base flood elevation.
 - d. Upon the completion of the structure, the elevation of the lowest floor including basement shall be certified by a register design professional licensed in the State of California to practice as such, and verified by the Building Official or a duly authorized representative to be properly elevated. Such certification or verification shall be provided to the Floodplain Administrator.
 3. Nonresidential construction, new or substantial improvement, shall either be elevated in conformance with Subsection 18.73.230.C.2 or, together with attendant utility and sanitary facilities, shall:
 - a. Be floodproofed below the elevation recommended under Subsection 18.73.230.C.2 so that the structure is watertight with walls substantially impermeable to the passage of water; and
 - b. Have structural components capable of resisting hydrostatic and hydrodynamic loads and effects of buoyancy; and
 - c. Be certified by a register design professional licensed in the State of California to practice as such that the standards of this Subsection 18.73.230.C.3 are satisfied. Such certification shall be provided to the Floodplain Administrator.
 4. All new construction and substantial improvement with fully enclosed areas below the lowest floor (excluding basements) that are usable solely for parking of vehicles, building access or storage, and which are subject to flooding, shall be designed to automatically equalize hydrostatic flood forces on exterior walls by allowing for the entry and exit of floodwater. Designs for meeting this requirement must meet or exceed the following minimum criteria:
 - a. Be certified by a register design professional licensed in the State of California to practice as such; or
 - b. Have a minimum of two (2) openings having a total net area of not less than one square inch for every square foot of enclosed area subject to flooding. The bottom of all openings shall be no higher than one (1) foot above grade. Openings may be equipped with screens, louvers, valves or other coverings or devices provided that they permit the automatic entry and exit of floodwater.
 5. Manufactured homes shall also meet the standards in Section 18.73.260.

18.73.240 – Standard for utilities.

- A. All new and replacement water supply and sanitary sewer systems shall be designed to minimize or eliminate infiltration of flood waters into the system and discharge from systems into flood waters.
- B. On-site waste disposal systems shall be located to avoid impairment to the system or contamination from the system during flooding.

18.73.250 – Standards for subdivisions.

- A. All preliminary subdivision proposals shall identify the flood hazard area and the elevation of the base flood.
- B. All final subdivision plans shall provide the elevation of proposed structures and pads. If the site is filled above the base flood, the final pad elevation shall be certified by a register design professional licensed in the State of California to practice as such and provided to the Floodplain Administrator.
- C. All subdivision proposals shall be consistent with the need to minimize flood damage.
- D. All subdivision proposals shall have public facilities and utilities such as sewer, gas, electrical and water systems located and constructed to minimize flood damage.
- E. All subdivisions shall provide adequate drainage to reduce exposure to flood hazards.

18.73.260 – Standards for manufactured homes and manufactured home parks and subdivisions.

- A. All manufactured homes that are placed or substantially improved, within zones A1-30, AH, and AE on the community's Flood Insurance Rate Map, on sites located:
 - 1. Outside of a manufactured home park or subdivision;
 - 2. In a new manufactured home park or subdivision;
 - 3. In an expansion to an existing manufactured home park or subdivision; or
 - 4. In an existing manufactured home park or subdivision on a site upon which a manufactured home has incurred "substantial damage" as the result of a flood, shall be elevated on a permanent foundation such that the lowest floor of the manufactured home is elevated to or above the base flood elevation and be securely anchored to an adequately anchored foundation system to resist flotation, collapse and lateral movement.
- B. All manufactured homes that are placed or substantially improved on sites located within Zones V1-30, V, and VE on the community's Flood Insurance Rate Map will meet the requirements of Subsection 18.73.260A and Section 18.73.300.
- C. All manufactured homes to be placed or substantially improved on sites in an existing manufactured home park or subdivision within Zones A1-30, AH, AE, V1-30, V, and VE on the community's Flood Insurance Rate Map that are not subject to the provisions of Subsection 18.73.260.A will be securely fastened to an adequately anchored foundation system to resist flotation, collapse, and lateral movement, and be elevated so that either the:
 - 1. Lowest floor of the manufactured home is at or above the base flood elevation; or
 - 2. Manufactured home chassis is supported by reinforced piers or other foundation elements of at least equivalent strength that are no less than thirty-six (36) inches in height above grade.

18.73.270 – Standards for recreational vehicles.

- A. All recreational vehicles placed on sites within zones A1-30, AH, and AE on the community's Flood Insurance Rate Map will either:
 - 1. Be on the site for fewer than one hundred eighty (180) consecutive days, and be fully licensed and ready for highway use—a recreational vehicle is ready for highway use if it is on its wheels or jacking system, is attached to the site only by quick disconnect type utilities and security devices, and has no permanently attached additions, or
 - 2. Meet the permit requirements of Sections 18.73.120 through 18.73.210 of this chapter and the elevation and anchoring requirements for manufactured homes in Subsection 18.73.260.A.
- B. Recreation vehicles placed on sites within Zones V1-30, V, and VE on the community's Flood Insurance Rate Map will meet the requirements of Subsection 18.73.270.A and Section 18.73.300.

18.73.280 – Floodways.

Located within areas of special flood hazard established in Section 18.73.060 are areas designated as floodways. Since the floodway is an extremely hazardous area due to the velocity of flood waters which carry debris, potential projectiles, and erosion potential, the following provisions apply:

- A. Prohibit encroachments, including fill, new construction, substantial improvement, and other new development unless certification by a register design professional licensed in the State of California to practice as such is provided demonstrating that encroachments shall not result in any increase in the base flood elevation during the occurrence of the base flood discharge.
- B. If Subsection 18.73.280.A is satisfied, all new construction, substantial improvement, and other proposed new development shall comply with all other applicable flood hazard reduction provisions of Sections 18.73.230 through 18.73.300.

18.73.290 – Construction standards for AR zone areas.

Within areas designated as AR, AR/A1-30, AR/AE, AR/AH, AR/AO, or AR/A, the following standards shall apply:

- A. Developed areas. All new construction in areas designated as developed areas shall meet the standards of Section 18.73.230 using the lower of either the AR base flood elevation or the elevation that is three (3) feet above the highest adjacent grade.
- B. Areas not designated as developed areas. All new construction in areas that are not designated as developed areas:
 - 1. Where the AR flood depth is equal to or less than five (5) feet above the highest adjacent grade, shall meet the standards of Section 18.73.230 using the lower of either the AR base flood elevation or the elevation that is three (3) feet above the highest adjacent grade.
 - 2. Where the AR flood depth is greater than five (5) feet above the highest adjacent grade, shall meet the standards of Section 18.73.230 using the AR base flood elevation.
- C. Dual zone areas.
 - 1. All new construction in areas within zone AR/A1-30, AR/AE, AR/AH, AR/AO, AR/A shall meet the standards of Section 18.73.230 using the higher of either the applicable AR zone

elevation (as determined from Subsection 18.73.290.A or 18.73.290.B above) or the base flood elevation (or flood depth) for the underlying A1-30, AE, AH, AO, or A zone.

2. All substantial improvements to existing construction within zones AR/A1-30, AR/AE, AR/AH, AR/AO, or AR/A shall meet the standards of Section 18.73.230 using the base flood elevation (or flood depth) for the underlying A1-30, AE, AH, AO, or A zone.

18.73.300 – Coastal high hazard area.

Within coastal high hazard areas as established under Section 18.73.060, the following standards shall apply:

- A. All new construction and substantial improvement shall be elevated on adequately anchored pilings or columns and securely anchored to such pilings or columns so that the lowest horizontal portion of the structural members of the lowest floor (excluding the pilings or columns) is elevated to or above the base flood level. The pile or column foundation and structure attached thereto is anchored to resist flotation, collapse, and lateral movement due to the effects of wind and water loads acting simultaneously on all building components. Water loading values used shall be those associated with the base flood. Wind loading values used shall be those required by applicable State or local building standards.
- B. All new construction and other development shall be located on the landward side of the reach of mean high tide.
- C. All new construction and substantial improvement shall have the space below the lowest floor free of obstructions or constructed with breakaway walls as defined in Section 18.73.040. Such enclosed space shall not be used for human habitation and will be usable solely for parking of vehicles, building access or storage.
- D. Fill shall not be used for structural support of buildings.
- E. Manmade alteration of sand dunes which would increase potential flood damage is prohibited.
- F. The Floodplain Administrator shall obtain and maintain the following records:
 1. Certification by a registered engineer or architect that a proposed structure complies with Subsection 18.73.300.A; and
 2. The elevation (in relation to mean sea level) of the bottom of the lowest structural member of the lowest floor (excluding pilings or columns) of all new and substantially improved structures, and whether such structures contain a basement.

18.73.310 – Nature of variances.

The variance criteria set forth in this chapter are based on the general principle of zoning law that variances pertain to a piece of property and are not personal in nature. A variance may be granted for a parcel of property with physical characteristics so unusual that complying with the requirements of this chapter would create an exceptional hardship to the applicant or the surrounding property owners. The characteristics must be unique to the property and not be shared by adjacent parcels. The unique characteristic must pertain to the land itself, not to the structure, its inhabitants, or the property owners.

It is the duty of the City to help protect its citizens from flooding. This need is so compelling and the implications of the cost of insuring a structure built below flood level are so serious that variances from the flood elevation or from other requirements in this chapter are quite rare. The long-term goal of preventing and reducing flood loss and damage can only be met if variances are strictly limited. Therefore, the variance guidelines provided in this chapter are more detailed and contain multiple

provisions that must be met before a variance can be properly granted. The criteria are designed to screen out those situations in which alternatives other than a variance are more appropriate.

18.73.320 – Variance procedure.

- A. The Floodplain Administrator shall hear and decide requests for variances from the requirements of this chapter.
- B. In passing upon requests for variances, the Floodplain Administrator shall consider all technical evaluations, all relevant factors, standards specified in other sections of this chapter, and:
 - 1. The danger that materials may be swept onto other lands to the injury of others;
 - 2. The danger to life and property due to flooding;
 - 3. The susceptibility of the proposed facility and its contents to flood damage and the effect of such damage on the existing individual owner and future owners of the property;
 - 4. The importance of the services provided by the proposed facility to the community;
 - 5. The necessity to the facility of a waterfront location, where applicable;
 - 6. The availability of alternative locations for the proposed use which are not subject to flooding damage;
 - 7. The compatibility of the proposed use with existing and anticipated development;
 - 8. The relationship of the proposed use to the comprehensive plan and floodplain management program for that area;
 - 9. The safety of access to the property in times of flood for ordinary and emergency vehicles;
 - 10. The expected heights, velocity, duration, rate of rise, and sediment transport of the flood waters and the effects of wave action, if applicable, expected at the site; and
 - 11. The costs of providing governmental services during and after flood conditions, including maintenance and repair of public utilities and facilities such as sewer, gas, electrical, and water systems, and streets and bridges.
- C. Any person aggrieved by the decision of the Floodplain Administrator may, within ten (10) days from the date the aggrieved party is notified in writing of the decision, appeal such decision to the City Council by filing a written notice thereof with the City Clerk. The City Council's decision shall be reduced to writing and shall be served by mail on the aggrieved party within ten (10) days after all evidence has been received by the City Council. The decision of the City Council shall be final.
- D. Generally, variances may be used for new construction and substantial improvements to be erected on a lot of one-half (1/2) acre or less in size contiguous to and surrounded by lots with existing structures constructed below the base flood level, providing Items 1 through 11 in Subsection 18.73.320.B and the procedures set forth in Sections 18.73.120 through 18.73.300 have been fully considered. As the lot size increases beyond one-half (1/2) acre, the technical justification required for issuing the variance increases.
- E. Upon consideration of the factors of Subsection 18.73.320.B and the purposes of this chapter, the Floodplain Administrator may attach such conditions to the granting of variances as it deems necessary to further the purposes of this chapter.

- F. The Floodplain Administrator shall maintain the records of all variance actions, including justification for their issuance, and report any variances issued in its biennial report submitted to the Federal Insurance Administration, Federal Emergency Management Agency.
- G. Any applicant to whom a variance is granted shall be given written notice over the signature of the Floodplain Administrator that:
 - 1. The issuance of a variance to construct a structure below the base flood level will result in increased premium rates for flood insurance up to amounts as high as twenty-five dollars (\$25.00) for one hundred dollars (\$100.00) of insurance coverage, and
 - 2. Such construction below the base flood level increases risks to life and property. A copy of the notice shall be recorded by the Floodplain Administrator in the Office of the Los Angeles County Recorder and shall be recorded in a manner so that it appears in the chain of title of the affected parcel of land.

18.73.330 – Conditions for variances.

- A. Variances may be issued for the repair or rehabilitation of "historic structures" (as defined in Section 18.73.040) upon a determination that the proposed repair or rehabilitation will not preclude the structure's continued designation as an historic structure and the variance is the minimum necessary to preserve the historic character and design of the structure.
- B. Variances shall not be issued within any mapped regulatory floodway if any increase in flood levels during the base flood discharge would result.
- C. Variances shall only be issued upon a determination that the variance is the minimum necessary, considering the flood hazard, to afford relief. "Minimum necessary" means to afford relief with a minimum of deviation from the requirements of this chapter. For example, in the case of variances to an elevation requirement, this means the City Council need not grant permission for the applicant to build at grade, or even to whatever elevation the applicant proposes, but only to that elevation which the City Council believes will provide relief and preserve the integrity of this chapter.
- D. Variances shall only be issued upon:
 - 1. A showing of good and sufficient cause;
 - 2. A determination that failure to grant the variance would result in exceptional hardship (as defined in Section 18.73.040) to the applicant; and
 - 3. A determination that the granting of a variance will not result in increased flood heights, additional threats to public safety, extraordinary public expense, create nuisances (as defined in Section 18.73.040—see "Public safety and nuisance"), cause fraud on or victimization (see Section 18.73.040) of the public, or conflict with existing local laws or ordinances.
- E. Variances may be issued for new construction, substantial improvement, and other proposed new development necessary for the conduct of a functionally dependent use provided that the provisions of Subsections 18.73.330.A through 18.73.330.D are satisfied and that the structure or other development is protected by methods that minimize flood damages during the base flood and does not result in additional threats to public safety and does not create a public nuisance.
- F. Upon consideration of the factors of Section 18.73.320 and the purposes of this chapter, the City Council may attach such conditions to the granting of variances as it deems necessary to further the purposes of this chapter.

Section 18.73.340 – Alternative Compliance.

Work performed in accordance with the California Building Code adopted in Chapter 18.40 or the California Residential Code adopted in Chapter 18.41 of this title shall be deemed to comply with the provisions of this chapter.

When the requirements of this chapter conflict with the requirements of any other part of the California Building Standards Code, Title 24 of the California Codes of Regulation, the most restrictive requirements shall prevail.

CHAPTER 18.74 LOW IMPACT DEVELOPMENT STANDARDS

18.74.010 – Purpose.

18.74.020 – Definitions.

18.74.030 – LID requirements and applicability.

18.74.040 – LID plan review.

18.74.050 – LID plan review, permit and Offsite Runoff Mitigation fees.

18.74.060 – LID Best Management Practices Manual.

18.74.070 – Hardship determination.

CHAPTER 18.74 LOW IMPACT DEVELOPMENT STANDARDS

18.74.010 – Purpose.

The purpose of this chapter is to require the use of low impact development (LID) standards in the planning and construction of development projects. LID standards promote the goal of environmental sustainability by helping improve the quality of receiving waters, protecting the Los Angeles and San Gabriel River watersheds, maintaining natural drainage paths, and protecting potable water supplies within the City. The LID objective of controlling and maintaining flow rate is addressed through land development and stormwater management techniques that imitate the natural hydrology (or movement of water) found on the site. Using site design and best management practices that allow for storage and retention, infiltration, filtering, and flowrate adjustments achieve the goals of LID, advances sustainability and reduces the overall cost of stormwater management. The use of engineered systems, structural devices, and vegetated natural designs distributes stormwater and urban runoff across a development site maximizing the effectiveness of LID.

18.74.020 – Definitions.

“Brownfield” means a piece of industrial or commercial property that is abandoned or underused and often environmentally contaminated, especially one considered as a potential site for redevelopment.

“Development” means any construction to build any new public or private residential projects (whether single-family, multi unit or planned unit development); new industrial, commercial, retail and other non-residential projects, including public agency projects; new impervious surface area; or mass grading for future construction. It does not include routine maintenance to maintain original line and grade, hydraulic capacity, or original purpose of facility, nor does it include emergency construction activities required to immediately protect public health and safety.

“LID Best Management Practices Manual” means a manual of LID standards and practices for stormwater pollution mitigation, including technical feasibility and implementation parameters, alternative compliance for technical infeasibility, as well as other rules, requirements and procedures as the City deems necessary, for implementing the provisions of this section of the Long Beach Municipal Code.

“Multi-Phased Project” shall mean any Development or Redevelopment implemented over more than one phase and the Site of a Multi-Phased Project shall include any land and water area designed and being used to store, treat or manage stormwater runoff in connection with the Development or Redevelopment, including any tracts, lots, or parcels of real property, whether Developed or not, associated with, functionally connected to, or under common ownership or control with such Development or Redevelopment.

“Offsite Runoff Mitigation Fee” means fee paid to the City for the management of storm water runoff generated from the 0.75-inch water quality storm in excess of the storm water runoff that is infiltrated, evapotranspired and/or stored for use. The Offsite Runoff Mitigation Fee shall be used by the City to construct or apply towards the construction of an offsite mitigation project within the same sub-watershed that will achieve at least the same level of water quality protection as if all of the runoff was retained on site.

“Redevelopment” means land-disturbing activities that result in the replacement of more than fifty percent (50%) of an existing building, structure or impervious surface area on an already developed site. It does not include routine maintenance to maintain original line and grade, hydraulic capacity, or original purpose of facility, nor does it include emergency construction activities required to immediately protect public health and safety or grinding/overlying and replacement of existing parking lots.

“Site” means the land or water area where any “facility or activity” is physically located or conducted,

including adjacent land use in connection with the facility or activity.

18.74.030 – LID requirements and applicability.

- A. The provisions of this section set forth the requirements for and shall apply to all new Development and Redevelopment projects in the City of Long Beach. The following Development or Redevelopment projects are exempt from the requirements of this chapter:
1. Any Development or Redevelopment projects that creates, adds or replaces less than five hundred (500) square feet of impervious surface area;
 2. Any Development or Redevelopment projects involving emergency construction activities required to immediately protect public health and safety;
 3. Any Development or Redevelopment projects involving the grinding/overlying and replacement of existing parking lots;
 4. Any Development or Redevelopment projects where land disturbing activities result in the replacement of fifty percent (50%) or less of an existing building, structure or impervious surface area; or
 5. Any Development or Redevelopment projects that are technically infeasible pursuant to Subsection 18.74.040.B; or
 6. Any Development or Redevelopment projects that do not require a building permit.
- B. LID requirements for new Development or Redevelopment projects:
1. Residential Development of 4 units or less
 - a. For new Development less than one (1) acre, or if Redevelopment alters more than fifty percent (50%) of existing buildings, structures or impervious surfaces of an existing developed site, comply with the standards and requirements of this chapter and implement at least two (2) adequately sized LID BMP alternatives from the LID Best Management Practices Manual.
 - b. For new Development that is one (1) acre and greater, the entire Site shall comply with the standards and requirements of this chapter and the LID Best Management Practices Manual.
 2. Residential Developments of 5 units or more and nonresidential Developments

For new Development, or if Redevelopment alters more than fifty percent (50%) of existing buildings, structures or impervious surfaces of an existing developed site, the entire Site shall comply with the standards and requirements of this chapter and of the LID Best Management Practices Manual.
 3. Nonresidential Developments in the Port of Long Beach Harbor District

For new Development or Redevelopment projects located in the Port of Long Beach Harbor District as designated in Title 21 Zoning Regulations, the site shall comply with the LID BMP alternatives set forth in the Port of Long Beach Post-Construction Design Guidance Manual and in the LID Best Management Practices Manual.
- C. This chapter shall not apply to those projects for which a building permit application has been filed for and deemed complete by the Building Official prior to February 19, 2013.

18.74.040 – LID plan review.

- A. Compliance with the LID standards of this chapter shall be demonstrated through a LID plan review. Permit applicant shall be required to submit a LID plan for review to the Building Official. The LID plan shall demonstrate how the project will meet the standards and requirements of this chapter and of the LID Best Management Practices Manual. A submitted LID plan shall indicate compliance with the following standards:
1. Stormwater runoff will be infiltrated, captured and reused, evapotranspired, and/or treated onsite through stormwater best management practices allowed in the LID Best Management Practices Manual.
 2. The onsite stormwater management techniques must be properly sized, at a minimum, to infiltrate, evapotranspire, and/or store for use without any storm water runoff leaving the site to the maximum extent feasible, for at least the volume of water produced by a storm event that results from:
 - a. The volume of runoff produced from a 0.75 inch storm event; or
 - b. The eighty-fifth (85th) percentile twenty-four (24) hour runoff event determined as the maximized capture stormwater volume for the area using a forty-eight (48) to seventy-two (72) hour draw down time, from the formula recommended in Urban Runoff Quality Management, WEF Manual of Practice No. 23/ASCE Manual of Practice No. 87, (1998); or
 - c. The volume of annual runoff based on unit basin storage water quality volume, to achieve eighty percent (80%) or more volume treatment by the method recommended in the California Stormwater Best Management Practices Handbook – Industrial/Commercial, (2003).
- B. When the onsite LID requirements are technically infeasible, the infeasibility shall be demonstrated in the submitted LID plan and shall be reviewed in consultation with the Building Official. The technical infeasibility may result from conditions that may include, but are not limited to:
1. Locations where seasonal high groundwater is within ten (10) feet of surface grade;
 2. Locations within one hundred (100) feet of a groundwater well used for drinking water;
 3. Brownfield Development sites or other locations where pollutant mobilization is a documented concern;
 4. Locations with potential geotechnical hazards; or
 5. Locations with impermeable soil type as indicated in applicable soils and geotechnical reports.
- C. If complete onsite compliance of any type is technically infeasible, a Development or Redevelopment project shall be required to comply with, at a minimum, all applicable Standard Urban Stormwater Mitigation Plan (SUSMP) requirements of Chapter 18.61 in order to maximize onsite compliance. For the remaining runoff that cannot feasibly be managed onsite, one or a combination of the following shall be required:
1. An Offsite Runoff Mitigation Fee pursuant to Subsection 18.74.050.B shall be paid to the City of Long Beach's Stormwater Pollution Abatement Fund for offsite mitigation, as described in the LID Best Management Practices Manual. The funding will be applied towards the construction of an offsite mitigation project(s) within the same sub-watershed that will achieve

at least the same level of water quality protection as if all of the runoff was retained onsite.

2. To provide an incentive for onsite management of storm water runoff, Development and Redevelopment projects will receive the following reduction in the Offsite Runoff Mitigation Fee based on the percentages of storm water runoff that is managed on site through infiltration, evapotranspiration, and/or capture and use:

Stormwater Runoff Managed Onsite	Fee Reduction
Between 90% and 99%	75%
Between 75% and 89%	50%
Between 50% and 74%	25%

3. A Multi-Phased Project must design a system acceptable to satisfy these standards and requirements for the entire Site during the first phase and will implement these standards and requirements for each phase of Development or Redevelopment projects of the Site during the first phase or prior to commencement of construction of a later phase, to the extent necessary to treat the stormwater from such later phase.

18.74.050 – LID plan check, permit, and Offsite Runoff Mitigation fees.

- A. Permit applicants who seeks to engage in new Development or Redevelopment as defined in this chapter by obtaining a building permit shall pay the required plan examination and permit fees as set forth in Chapter 18.06.
- B. Permit applicants who seeks to engage in new Development or Redevelopment as defined in this chapter by obtaining a building permit and does not demonstrate complete onsite compliance as described in the LID Best Management Practices Manual are required to pay an Offsite Runoff Mitigation Fee in the manner and amount as set forth in the schedule of fees and charges established by City Council resolution.
- C. Any Development or Redevelopment projects that are exempted from this chapter shall have the option to voluntarily opt in and incorporate into the project the LID requirements of this chapter. In such case, the LID plan review, permit and Offsite Runoff Mitigation fees associated with the project shall be waived.

18.74.60 LID Best Management Practices Manual.

- A. The Building Official shall prepare, maintain, and update, as deemed necessary and appropriate, the LID Best Management Practices Manual to include LID standards and practices and standards for stormwater pollution mitigation. The LID Best Management Practices Manual shall also include technical feasibility and implementation parameters, alternative compliance for technical infeasibility, as well as other rules, requirements and procedures as the City deems necessary, for implementing the provisions of this chapter.
- B. The Building Official shall develop, as deemed necessary and appropriate, in cooperation with other City departments and stakeholders, informational bulletins, training manuals and educational materials to assist in the implementation of the LID requirements.

18.74.070 – Hardship determination.

Whenever there are practical difficulties involved in carrying out the provisions of this chapter, the Director shall have the authority to grant modifications to the provisions of this chapter for individual cases, provided the Director shall first find that special individual reason makes the strict letter of this chapter impractical and the modification is in compliance with the intent and purpose of this chapter and that such modification does not lessen the goals of LID, sustainability or increase the overall cost of stormwater management.

CHAPTER 18.75 GRADING, EXCAVATIONS AND FILLS

- 18.75.010 – General.
- 18.75.020 – Definitions.
- 18.75.030 – Grading bonds in hazardous situations required.
- 18.75.040 – Excavations.
- 18.75.050 – Fills.
- 18.75.060 – Setbacks.
- 18.75.070 – Drainage and terracing.
- 18.75.080 – Erosion control.
- 18.75.090 – Referenced standards.

CHAPTER 18.75 GRADING, EXCAVATIONS AND FILLS

18.75.010 – General.

- A. Scope. The provisions of this chapter apply to grading, excavation and earthwork construction, including fills and embankments. Where conflicts occur between the technical requirements of this chapter and the soils or geotechnical report, the soils or geotechnical report shall govern.
- B. Permits required. Except as exempted in Section 18.04.020, no grading shall be performed without first having obtained a permit as required by Section 18.04.010 therefore from the Building Official.
- C. Submittal documents. The provisions of Chapter 18.05 shall apply to the submittal of grading construction documents, including soils and geotechnical reports and any other pertinent technical reports where the Building Official determines that the nature of the work applied for is such that a report is necessary.
- A. Inspection. Inspections shall be governed by Chapter 18.07.
- B. Flood hazard areas. The provisions of this chapter shall not apply to grading, excavation and earthwork construction, including fills and embankments, in floodways within flood hazard areas established in Section 1612.3 of the California Building Code adopted in Chapter 18.40 or in flood hazard areas where design flood elevations are specified but floodways have not been designated, unless it has been demonstrated through hydrologic and hydraulic analyses performed in accordance with standard engineering practice that the proposed work will not result in any increase in the level of the base flood.
- C. Consent of adjacent property owner. Whenever any excavation or fill requires entry onto adjacent property for any reason, the permit applicant shall obtain the written consent of the adjacent property owner or the owner's authorized representative, and shall file a copy of said consent with the Building Official before the commencement of such grading work.

In the event contours on adjacent properties are permanently changed, structures or drainage devices are added or modified, and/or the work done requires a grading permit under Section 18.04.010, a separate permit shall be required for each such affected adjoining property in addition to the consent letter. Furthermore, the adjacent property owner shall acknowledge his or her consent on plans showing such work. The consent letter will not be required if such grading permit is taken out by the adjacent property owner.

- F. Safety precaution during grading. If at any stage of work on an excavation or fill the Building Official determines that further work as authorized by an existing permit is likely to endanger any property or public way, the Building Official may require as a condition to allow the work to continue that plans for such work be amended to include adequate safety precautions. Safety precautions may include, but shall not be limited to, specifying a flatter exposed slope or construction of additional drainage facilities, berms, terracing, compaction, cribbing, retaining walls or buttress fills, sloughwalls, desilting basins, check dams, benching wire mesh and guniting, rock fences revetment or diversion walls.

No person shall excavate or fill so as to cause falling rocks, soil or debris in any form to fall, roll, slide or flow onto adjoining properties.

18.75.020 – Definitions.

For the purposes of this chapter, the terms, phrases and words listed in this section and their derivatives shall have the indicated meanings.

Bench. A relatively level step excavated into earth material on which fill is to be placed.

Compaction. The densification of a fill by mechanical means.

Cut. See excavation.

Down drain. A device for collecting water from a swale or ditch located on or above a slope, and safely delivering it to an approved drainage facility

Erosion. The wearing away of the ground surface as a result of the movement of wind, water or ice.

Excavation. The removal of earth material by artificial means, also referred to as a cut.

Fill. Deposition of earth materials by artificial means.

Grade. The vertical location of the ground surface.

Grade, existing. The grade prior to grading.

Grade, finished. The grade of the site at the conclusion of all grading efforts.

Grading. An excavation or fill or combination thereof.

Key. A compacted fill placed in a trench excavated in earth material beneath the toe of a slope.

Slope. An inclined surface, the inclination of which is expressed as a ratio of horizontal distance to vertical distance.

Terrace. A relatively level step constructed in the face of a graded slope for drainage and maintenance purposes.

18.75.030 – Grading bonds in hazardous situations required.

The Building Official may require a grading permit surety bond in such form and amounts as may be deemed necessary to assure that the grading work, if not completed in accordance with the approved plans and specifications, will be corrected to eliminate hazardous conditions as determined by the Building Official. The condition of such bond shall be that the permit applicant will perform the work authorized by the grading permit issued pursuant to this title in a good and workmanlike manner and to the satisfaction of the Building Official. When a grading permit surety bond is required, it shall comply with provisions Section 2.84.040 and this chapter.

A. Surety bond. Before a permit is issued for excavation or fill of two hundred and fifty (250) cubic yards (191.3 m³) or more of earth, the owner of the property shall file with the Building Official a bond for the benefit of the City. The bond shall be executed by the owner and a corporate surety authorized to do business in this state as a surety in an amount sufficient to cover the entire project.

EXCEPTION: Upon application by the owner, the Building Official may waive this requirement if:

1. The proposed grading is neither actually nor potentially hazardous;
2. The grading work performed is in compliance with an order issued by the Building Official; or
3. The permit applicant can substantiate, to the satisfaction of the Building Official, that the work under a grading permit will be fully executed.

- B. Cash bond. In lieu of a surety bond, the owner may file a cash bond with the Building Official on the same terms and conditions and in an amount equal to that which would be required in the surety bond. The deposit may be in the form of negotiable United States securities in lieu of cash.
- C. Application of bond to adjacent property. Where grading is required on property adjacent to the grading site under permit in order to complete a project satisfactorily, the owner of such adjacent property need not provide an additional grading bond if the original bond is of sufficient amount to include such additional grading.
- D. Conditions of the bond. Every bond shall be conditioned such that the owner shall:
 - 1. Comply with all applicable provisions of this title and all other ordinances of the City or laws and statutes of the State.
 - 2. Comply with all the terms and conditions of the grading permit to the satisfaction of the Building Official.
 - 3. Complete all the work described by the permit, and the plans and specifications relating thereto, within the time limit specified in the permit. Upon application by the permit applicant, the Building Official may, for sufficient cause, extend the time specified in the permit pursuant to Section 18.03.050, but no such extension shall release any surety on the bond.
 - 4. Install temporary erosion control devices when required to do so by the provisions of this chapter.
- E. Period and termination of bond. The term of each bond shall begin on the date of filing and shall remain in effect until the work is completed to the satisfaction of the Building Official or until replaced by a new bond in the event of a change of ownership. In the event of failure to complete the work and/or failure to comply with all the conditions and terms of the permit, the Building Official may order some or all of the work to be completed to correct any hazardous conditions. The surety executing such bond, or such deposit, shall continue to be firmly bound under a continuing obligation for the payment of all necessary costs and expenses that may be incurred or expended by the City in causing any and all of such required work to be done and that said surety or the depositor assents to any lawful extension of time within which to construct and complete such work. Such costs shall include an amount equal to the cost to the City of administering the contract and supervising the work required. In the case of a cash bond, the deposit, or any unused portion thereof, shall be refunded to the depositor upon completion of the work to the satisfaction of the Building Official. The Building Official may release or exonerate the bond under appropriate conditions when the public health and welfare is not jeopardized.
- F. New ownership. In the event of change of ownership during grading, the new owner shall secure a new grading permit and post a new bond to ensure completion of the grading.
- G. Amount of bond. The amount for the bond shall be set at the discretion of the Building Official, considering such factors as the size of the site, the amount of earth material in either excavation or fill, drainage requirements, and other protective devices as needed to secure the safety of the site..
- H. Installment refunds. When a substantial portion of the required grading work has been completed to the satisfaction of the Building Official, and when the completion of the remaining grading work, site development or planting is delayed, the Building Official may accept the completed portion of the grading work and consent to the proportionate reduction of the bond to an amount estimated to be adequate to ensure completion of the grading work, site development or planting remaining to be performed. Only one such reduction shall be considered for each bond posted.

- I. Entry upon premises. The Building Official, the surety company, or their duly authorized representative, shall have access to the premises described in the permit for the purpose of inspecting the progress of the work.

In the event of default in the performance of any terms or conditions of the permit, the surety or any person employed or engaged in his or her behalf shall have the right to go upon the premises to complete the required work, including the installation of temporary erosion control devices.

Should the permittee or the surety fail to perform the work described by the permit and the plans and specifications relating thereto or required by any applicable law, and it is determined by the Building Official that the public health, safety or general welfare is endangered by such failure, the Building Official may enter upon the premises to perform all or any part of such work, including the installation of temporary erosion control devices.

It shall be unlawful for the owner or any other person to interfere with the ingress and egress from such premises of any authorized representative or agent of any surety company or the City engaged in the work ordered by the Building Official.

18.75.040 – Excavations.

The slope of cut surfaces shall be no steeper than is safe for the intended use, and shall be no steeper than two (2) units horizontal to one (1) unit vertical (50-percent slope) unless the owner or authorized agent furnishes a geotechnical report justifying a steeper slope.

EXCEPTIONS:

1. A cut surface shall be permitted to be at a slope of 1.5 units horizontal to one (1) unit vertical (67-percent slope) provided that all of the following are met:
 - a. It is not intended to support structures or surcharges.
 - b. It is adequately protected against erosion.
 - c. It is no more than eight (8) feet (2438 mm) in height.
 - d. Ground water is not encountered.
 - e. It is approved by the Building Official.
2. A cut surface in bedrock shall be permitted to be at a slope of one (1) unit horizontal to one (1) unit vertical (100-percent slope).

This section shall not be construed to waive the requirements of the General Safety Orders of the California Department of Industrial Relations, nor the provisions of Section 832 of the California Civil Code concerning the rights of coterminous owners as to excavations.

18.75.050 – Fills.

- A. General. Unless otherwise recommended in the geotechnical report, fills shall comply with the provisions of this section.
- B. Surface preparation. The ground surface shall be prepared to receive fill by removing vegetation, topsoil and other unsuitable materials, and scarifying the ground to provide a bond with the fill material.
- C. Benching. Where existing grade is at a slope steeper than five (5) units horizontal to one (1) unit vertical (20-percent slope) and the depth of the fill exceeds five (5) feet (1524 mm) benching shall

be provided in accordance with Figure 18.75.050. A key shall be provided which is at least ten (10) feet (3048 mm) in width and two (2) feet (610 mm) in depth.

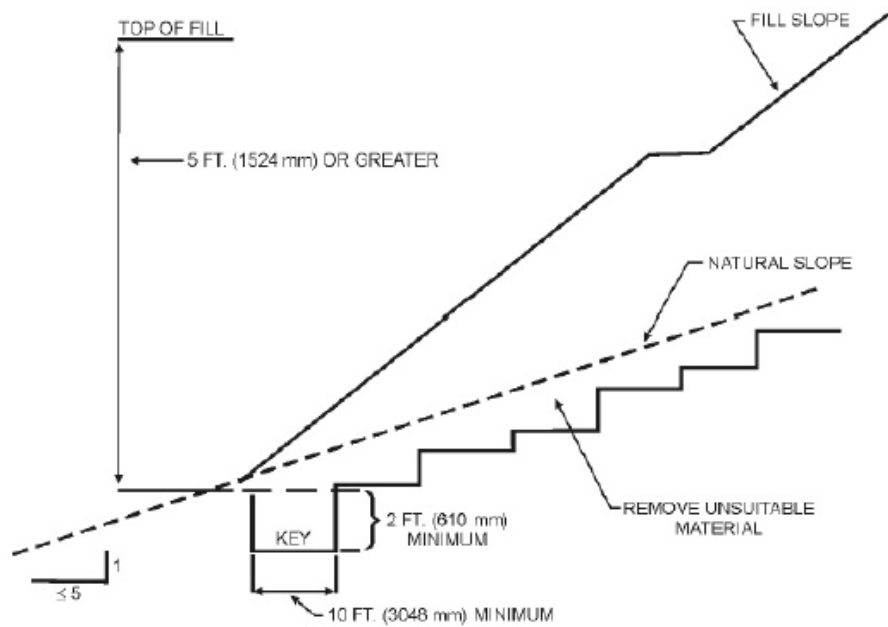

For SI: 1 foot = 304.8 mm.

FIGURE 18.75.050
BENCHING DETAILS

- D. Fill material. Fill material shall not include organic, frozen or other deleterious materials. No rock or similar irreducible material greater than twelve (12) inches (305 mm) in any dimension shall be included in fills.
- E. Compaction. All fill material shall be compacted to ninety (90) percent of maximum density as determined by ASTM D 1557, Modified Proctor, in lifts not exceeding twelve (12) inches (305 mm) in depth. Where cohesionless soil having less than fifteen (15) percent finer than 0.005 millimeter is used for fill, it shall be compacted to a minimum of ninety-five (95) percent relative compaction based on maximum dry density. Every fill shall be tested for relative compaction by a soil testing agency approved by the Building Official. A compaction report including a Certificate of Compliance setting forth densities so determined shall be submitted to the Building Official before approval of any fill is given.
- F. Maximum slope. The slope of fill surfaces shall be no steeper than is safe for the intended use. Fill slopes steeper than two (2) units horizontal to one (1) unit vertical (50-percent slope) shall be justified by a geotechnical report or engineering data.

18.75.060 – Setbacks.

- A. General. Cut and fill slopes shall be set back from the property lines in accordance with this section. Setback dimensions shall be measured perpendicular to the property line and shall be as shown in Figure 18.75.060, unless substantiating data is submitted justifying reduced setbacks.

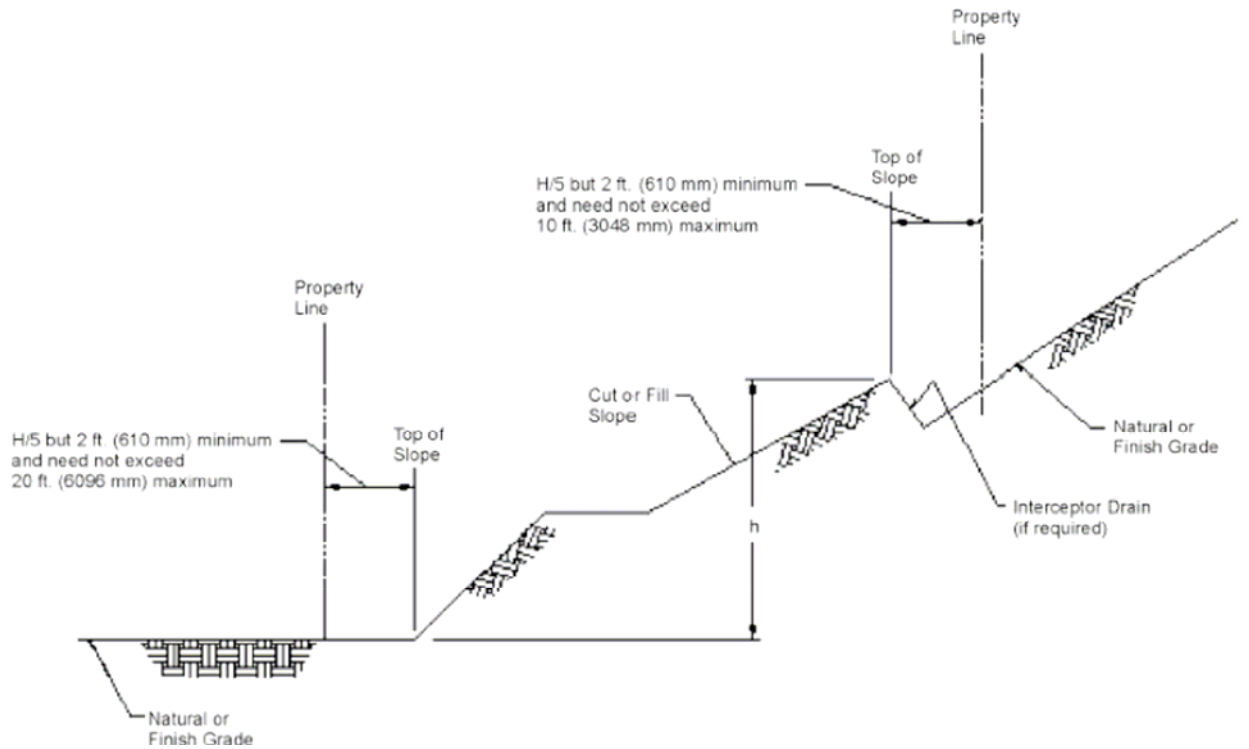

For SI: 1 foot = 304.8 mm.¹

FIGURE 18.75.060
DRAINAGE DIMENSIONS

- B. Top of slope. The setback at the top of a cut slope shall not be less than that shown in Figure 18.75.060, or than is required to accommodate any required interceptor drains, whichever is greater.
- C. Slope protection. Where required to protect adjacent properties at the toe of a slope from adverse effects of the grading, additional protection, approved by the Building Official, shall be included. Such protection may include but shall not be limited to:
 1. Setbacks greater than those required by Figure 18.75.060.
 2. Provisions for retaining walls or similar construction.
 3. Erosion protection of the fill slopes.
 4. Provisions for the control of surface waters.

18.75.070 – Drainage and terracing.

- A. General. Unless otherwise recommended by a registered design professional, drainage facilities and terracing shall be provided in accordance with the requirements of this section.

EXCEPTION: Drainage facilities and terracing need not be provided where the ground slope is not steeper than three (3) unit horizontal to one (1) unit vertical (33percent slope).

- B. Terraces. Terraces at least six (6) feet (1829 mm) in width shall be established at not more than thirty (30) foot (9144 mm) vertical intervals on all cut or fill slopes to control surface drainage and debris. Suitable access shall be provided to allow for cleaning and maintenance.

Where more than two (2) terraces are required, one (1) terrace, located at approximately mid-height, shall be at least twelve (12) feet (3658 mm) in width.

Swales or ditches shall be provided on terraces. They shall have a minimum gradient of twenty (20) unit horizontal to one (1) unit vertical (5-percent slope) and shall be paved with concrete not less than three (3) inches (76 mm) in thickness, or with other materials suitable to the application. They shall have a minimum depth of twelve (12) inches (305 mm) and a minimum width of five (5) feet (1524 mm).

A single run of swale or ditch shall not collect runoff from a tributary area exceeding thirteen thousand and five hundred (13,500) square feet (1256 m²) (projected) without discharging into a down drain.

- C. Interceptor drains. Interceptor drains shall be installed along the top of cut slopes receiving drainage from a tributary width greater than forty (40) feet (12 192 mm), measured horizontally. They shall have a minimum depth of one (1) foot (305 mm) and a minimum width of three (3) feet (915 mm). The slope shall be approved by the Building Official, but shall not be less than fifty (50) unit horizontal to one (1) unit vertical (2-percent slope). The drain shall be paved with concrete not less than three (3) inches (76 mm) in thickness, or by other materials suitable to the application. Discharge from the drain shall be accomplished in a manner to prevent erosion and shall be approved by the Building Official.
- D. Drainage across property lines. Drainage across property lines shall not be permitted except for drainage that does not exceed that which existed prior to grading. Excess or concentrated drainage shall be contained on site or directed to an approved drainage facility. Erosion of the ground in the area of discharge shall be prevented by installation of nonerosive down drains or other devices.
- E. Site drainage. All pads with cut or fill shall slope a minimum of two (2) percent to an approved drainage device or to a public street. Where used, the drainage device shall be an adequately designed system of catch basins and drain lines that conducts the water to a public street.

EXCEPTION: Where the slope of the underlying natural ground does not exceed three (3) percent and the compacted fill is less than three (3) feet (914mm) in depth, the slope of the pad may be reduced to one (1) percent.

- F. Drainage around buildings. On all building sites, acceptable drainage devices shall be installed to conduct water around buildings whenever the distance from the building to the top of any slope is less than five (5) feet (1524 mm). Where used, the drainage device shall be an adequately designed system of catch basins and drain lines that conducts the water to a public street.
- G. Maintenance of drainage. Drainage in conformance with the provisions of this chapter shall be maintained during and subsequent to construction.

18.75.080 – Erosion control.

- A. General. The faces of cut and fill slopes shall be prepared and maintained to control erosion. This control shall be permitted to consist of effective planting.

EXCEPTION: Erosion control measures need not be provided on cut slopes not subject to erosion due to the erosion-resistant character of the materials.

Erosion control for the slopes shall be installed as soon as practicable and prior to calling for final inspection.

- B. Other devices. Where necessary, check dams, cribbing, riprap or other devices or methods shall be employed to control erosion and provide safety.

18.75.090 – Referenced standards.

ASTM D1557-e01 Test Method for Laboratory Compaction Characteristics of Soil Using Modified Effort [56,000 ft-lb/ft³ (2,700kn-m/m³)].

CHAPTER 18.76 WATER SUBMETERS

18.76.010 – Purpose.

18.76.020 – Application.

18.76.030 – Submeter requirements.

CHAPTER 18.76 WATER SUBMETERS

18.76.010 – Purpose.

The City is reliant on imported water, importing as much as 40% from the Metropolitan Water District. To address the impact of imminent water supply shortage as the result of a statewide, multi-year droughts, critically low levels in key state reservoirs and significant pumping restrictions on imported water supplies from the State Water Project, it is necessary to increase water conservation efforts to ensure sufficient water resources is available for current and future residents of the City. Nearly 36% of water usage in the City can be attributed to multifamily residential or mixed-use buildings where water consumption in each individual dwelling unit is not measured. This chapter encourages water conservation in multifamily residential and mixed-use buildings by requiring the installation of water submeters for individual dwelling units to help building owners to allocate water costs based upon water consumption in the unit and create a financial incentive for residents to conserve water.

18.76.020 – Application.

- A. This chapter applies to newly constructed multifamily residential building or newly constructed mixed-use residential and commercial building with three or more dwelling units for which a permit application is submitted on or after July 1, 2014 or as determine otherwise by the Building Official when justifiable cause is demonstrated.

EXCEPTIONS: Structures in the all of the following categories shall be exempt from this chapter.

1. Low income or affordable housing pursuant to a recorded regulatory agreement with a governmental agency as determined by the Department of Development Services.
2. Student dormitories.
3. Long-term health care facilities as defined in Section 1418 of the California Health and Safety Code.
4. Time-share property as defined in subdivision (aa) of Section 11212 of the California Business and Professions Code.
5. Residential care facilities as defined in subdivision (k) of Section 1569.2 of the California Health and Safety Code, or existing buildings.
6. High-rise buildings if it can be demonstrates to the satisfaction of the Building Official that the building's plumbing configuration incorporates multiple points of entry in each dwelling unit and renders the installation of water submeters infeasible.

- B. Nothing herein shall be construed to limit or alter any existing regulations related to testing and oversight of water submeters by the California Department of Food and Agriculture, Division of Measurement Standards.

18.76.030 – Submeter Requirements.

- A. Water submeters shall be installed to measure the volume of water supplied to each individual dwelling unit.
- B. Water submeters shall be located such that the primary submeter indicator or remote reader may be easily accessed and read by the tenant of the dwelling unit and the owner or owner's authorized agent of the multifamily residential or mixed-use residential and commercial building without entering the dwelling unit.

- C. Water submeters shall comply with all laws and regulations governing the approval of submeter types or the installation, maintenance, reading, billing, and testing of submeters, including, but not limited to, the California Plumbing Code adopted in Chapter 18.43.
- D. Water submeters shall be of a type approved pursuant to Section 12500.5 of the California Business and Professions Code, and shall be installed and operated in compliance with regulations established pursuant to Section 12107 of the California Business and Professions Code.

CHAPTER 18.99 FINDINGS

18.99.010 – Purpose.

CHAPTER 18.99 FINDINGS

18.99.010 – Purpose.

- A. The provisions of this title contain certain changes, deletions, modifications and additions to The 2013 Edition of the California Building Standards Code adopted by the City. Chapters and sections of this title, including the amendments herein, are considered amendments to the California Building Standards Code and Appendices. Some of these changes are administrative in nature in that they do not constitute changes, modifications or additions to the California Building Standards Code.

- B. Pursuant to Sections 17958.5 and 17958.7 of the California Health and Safety Code, the City Council has, by resolution made specific findings of fact and determinations relative to the unique climatic, geological or topographical conditions existing in Long Beach that necessitate amendment to the various applicable California Building Standards Code. A copy of said resolution shall be on file with the office of the City Clerk.