



Robert E. Shannon  
City Attorney of Long Beach  
333 West Ocean Boulevard  
Long Beach, California 90802-4664  
Telephone (562) 570-2200

1 conspicuous places in the City of Long Beach, and it shall take effect on the thirty-first  
2 day after it is approved by the Mayor.

3 I hereby certify that the foregoing ordinance was adopted by the City Council of  
4 the City of Long Beach at its meeting of \_\_\_\_\_, 2006, by the  
5 following vote:

6 Ayes: Councilmembers: \_\_\_\_\_  
7 \_\_\_\_\_  
8 \_\_\_\_\_  
9 \_\_\_\_\_

10 Noes: Councilmembers: \_\_\_\_\_  
11 \_\_\_\_\_

12 Absent: Councilmembers: \_\_\_\_\_  
13 \_\_\_\_\_

14 \_\_\_\_\_  
15 City Clerk

16 Approved: \_\_\_\_\_  
17 \_\_\_\_\_  
18 Mayor

# **DOWNTOWN PLANNED DEVELOPMENT DISTRICT (PD-30)**

<b>TABLE OF CONTENTS</b>		<b>PAGE</b>
Division I.	Intent	2
Division II.	Planning Districts	3
Division III.	Commercial and Mixed Use Districts	5
Division IV.	Residential Districts	25
Division V.	Park District	32
Division VI.	Institutional/Government District	33
Division VII.	Public Improvement Requirements	35
Division VIII.	General Development Standards	36
Division IX.	Preservation of Historic Structures	39
Division X.	East Village Live-Work Provisions	41
Division XI.	Development Approval Process	43
<b>List of Maps</b>		
Map 1	Planned Sub-areas	45
Map 2	Required Setbacks, Areas Requiring Pedestrian-Oriented Ground Floor Uses and Zero Setback Areas	46
Map 3	Maximum Building Height	47
Appendix A	Downtown Street Tree Species	48

Ordinance History: C-7694, 2000; C-7719, 2000; C-7830, 2002; C-7884, 2003, C-7950, 2004; 05-0009, 2005

## **Division I. Intent of the Downtown Planned Development Ordinance**

The intent of this Planned Development Ordinance is to implement the following goals and objectives:

- Long Beach will build its downtown into a multi-purpose activity center of regional significance, offering a wide variety of activities which result in an environment that is attractive and exciting during both the daylight and evening hours.
- Planning efforts must focus on connecting the various “districts” of Downtown into a cohesive and functional whole which coordinates the activities of the downtown proper not only amongst themselves but in conjunction with the redevelopment of the downtown shoreline.
- Long Beach will support efforts aimed at preserving significant historic and cultural places and buildings. New buildings should respect and complement existing historic structures. The City supports the development of cultural and artistic offerings in the downtown.
- Quality design and materials are of paramount importance in the downtown. Architectural continuity within the downtown will be achieved through consistency in the quality of design, workmanship, and materials utilized.
- Long Beach accepts the population growth anticipated in the downtown and supports the development of more park/recreation open space, new quality residential units, added commercial/retail goods and services, and additional space for educational facilities required to support a growing downtown population.
- Long Beach will create safe, attractive and comfortable downtown streetscapes emphasizing a pedestrian focus and a quality physical environment. Long Beach will clearly define vehicular and pedestrian roles for each downtown street. Well-defined routes will create a clear linkage pattern between the various activity centers of the downtown and the downtown shoreline.
- The City intends to develop a public walkway and landscaping improvement plan for the Downtown. The future plan will address improvements such as landscaping, paving treatment and street furniture as well as funding methods.

In reviewing development proposals and land use issues, the City Council, Planning Commission, Redevelopment Agency Board and Site Plan Review Committee shall be directed by these goals and objectives.

## **Division II. Planning Districts**

The Downtown planning area is divided into eight districts. These districts are illustrated by Map 1. The intent and general standards for each of these districts are as follows:

- **Park District**

This district has been developed as Cesar E. Chavez Park, a public park and will be dedicated in perpetuity as a public park. Development in the park is limited to park/community-related structures such as recreation and community buildings. Development should be consistent with the open character of the park. For specific standards, refer to Chapter 21.35 of the Long Beach Municipal Code (Park District).

- **Institutional and Government District**

This district contains major government buildings along with several churches and schools. Development in this district will vary based on the location of the site within the Downtown area. Lincoln Park is a public park within this district.

- **Downtown Core District**

This district is the center of Downtown. A mix of uses, including office, retail, entertainment and high density residential are encouraged. High-rise and mid-rise developments are permitted in this area.

- **Promenade District**

This district is intended to provide opportunities for a range of entertainment and visitor serving commercial uses. The Promenade shall be preserved as an essential pedestrian link between Downtown's commercial districts and the Queensway Bay development.

- **Downtown Mixed Use District**

This district applies to those areas surrounding the Downtown Core area, and for major street corridors outside of the central core. This district permits a mix of commercial and residential uses at heights of up to 100'.

- **East Village Mixed Use District**

This district is intended to provide opportunities for the continued growth of the East Village Arts District through reuse of existing buildings and new development. As envisioned, this district will contain a mix of moderate density residential uses, active ground floor storefronts, live/work spaces and arts related uses.

- **West End Residential District**

This district applies to the residential area west of the Downtown core. This district is intended to provide moderate to high density housing opportunities for persons working in the Downtown area.

- **East Village Residential District**

New development in this residential district is limited to low to moderate densities, consistent with the character of the residential area in the vicinity of the Saint Anthony's campus.

## **Division III. Commercial and Mixed Use Districts**

These standards apply to the Downtown Core Mixed Use District, Promenade District, East Village Mixed Use District and Downtown Mixed Use District.

### **A. Permitted Uses**

#### **1. Table of Permitted, Discretionary and Prohibited Uses**

Table 1 on the following pages defines the uses permitted in the Mixed Use Districts, the Downtown Core District and the Promenade Commercial district. The table uses the following abbreviations:

Y = Yes (permitted use).

N = Not permitted.

C = Conditional use permit required. For special conditions, refer to Chapter 21.52.

A = Accessory use. For special development standards, refer to Chapter 21.51.

AP= Administrative use permit required. For special conditions, refer to Chapter 21.52.

T = Temporary use subject to provisions contained in Chapter 21.53.

IP = Interim park use permit required. For special conditions, refer to Chapter 21.52.

#### **2. Adult Entertainment**

Any business considered an “adult entertainment business”, as defined in Subsections 21.15.110A through 21.15.110K of the Long Beach Municipal Code, shall be regulated in the same manner as a similar non-adult entertainment business and shall be subject to the Special Development Standards, Section 21.45.110 (Adult Entertainment Businesses).

### **B. Residential Development In Commercial and Mixed Use Districts**

Residential Development in the Mixed Use Districts shall comply with the densities and development standards established in Division IV (Residential Districts) of this document.

Downtown Planned Development District (PD-30)

**TABLE 1 - Uses in the Commercial and Mixed Use Districts**

		Promenade District	Downtown Core District	Downtown Mixed Use District	East Village Mixed Use District
ALCOHOLIC BEVERAGE SALES:	Off-premise sales	C	C <sup>(a)</sup>	C <sup>(a)</sup>	C <sup>(a)</sup>
	On-premise sales	Y	Y	C <sup>(a)</sup>	C <sup>(a)</sup>
AUTOMOBILE (VEHICLE USES):	Auto Detailing (with hand held machines only)	AP <sup>(b)</sup>	AP <sup>(b)</sup>	AP <sup>(b)</sup>	AP <sup>(b)</sup>
	Car Wash	N	N	N	N
	Gasoline Sales	N	N	C	C
	General Auto Repair (body work, painting, etc.)	N	N	N	N
	Minor Auto Repair, Tune-Up & Lube, Smog Test	AP <sup>(b)</sup>	AP <sup>(b)</sup>	AP <sup>(b)</sup>	AP <sup>(b)</sup>
	Limousine Service (Does not include auto repair)	N	AP/A <sup>(c)</sup>	AP	AP
	Motorcycle/Jet Ski Sales & Repair	N	N	N	N
	Surface Parking Lot- principal use	AP <sup>(d)</sup>	AP <sup>(d)</sup>	AP	AP
	Parking Structure- principal use	N	AP	AP	AP
	Recreational Vehicle Storage	N	N	N	N
	Rental Agency (does not include repair)	N	AP/A <sup>(c)</sup>	AP	N
	Sales (outdoor)	N	N	N	N
	Sales (indoor showroom only)	N	Y	Y	AP
Towing	N	N	A	A	
Vehicle Parts (with installation; Tire Store)	N	N	N	N	
Vehicle parts (without installation)	N	AP	AP	AP	
BILLBOARDS:	Mini-poster or Poster Board	N	N	N	N



Downtown Planned Development District (PD-30)

**TABLE 1 - Uses in the Commercial and Mixed Use Districts**

		<b>Promenade District</b>	<b>Downtown Core District</b>	<b>Downtown Mixed Use District</b>	<b>East Village Mixed Use District</b>
<b>BUSINESS OFFICE SUPPORT:</b>	Copy, Fax, Mail Box, or Supplies	Y	Y	Y	Y
	Equipment Sales, Rental, or Repair	N	Y	Y	Y
	Off-set Printing	N	AP	AP	AP
<b>ENTERTAINMENT</b>	Amusement Machines (4 or fewer)	A	A	A	A
	Dancing (accessory use)	Y	Y	Y	Y
	Hall Rental	Y	AP	AP	AP
	Banquet Room Rental (within a restaurant/hotel)	A	A	A	A
	Live or Movie Theater (w/100 seats or less)	Y	Y	Y	Y
	Movie Theater, IMAX, IWORKS or Live Theater (w/100 + seats)	Y	Y	C	C
	Private Club, Social Club, Night Club, Pool Hall (e)	Y	Y	C	C
	Restaurant with Entertainment (e)	Y	Y	Y	Y
	Arcade, Bowling Alley, Miniature Golf, Tennis Club, Skating Rink	C	C	C	C
	Computer Arcade	C	C	C	C
<b>FINANCIAL SERVICES:</b>	ATM (walk-up machine)	Y	Y	Y	Y
	Bank, Credit Union, Saving & Loan (without drive-thru window)	Y	Y	Y	Y
	Bank, Credit Union, Saving & Loan (with drive-thru window)	N	N	AP	AP
	Check Cashing	N	N	A <sup>(k)</sup>	A <sup>(k)</sup>

**TABLE 1 - Uses in the Commercial and Mixed Use Districts**

		Promenade District	Downtown Core District	Downtown Mixed Use District	East Village Mixed Use District
	Escrow, Stocks & Bonds Broker	Y	Y	Y	Y
<b>INSTITUTIONAL USES:</b>	Church or Temple	N	C	C	C
	Convalescent Hospital or Home	N	N	C	C
	Crematorium	N	N	N	N
	Day Care or Pre-school	AP <sup>(f)</sup>	Y <sup>(f)</sup>	Y	Y
	Elementary or Secondary School	N	AP	AP	AP
	Industrial Arts Trade School or Rehabilitation Workshop	AP	AP	AP	AP
	Museum	Y	Y	Y	Y
	Mortuary	N	N	N	N
	Parsonage	N	A	A	A
	Professional School/ Business School	Y	Y	Y	Y
	Social Service Office with or without food distribution <sup>(f)</sup>	N	C	C	C
	Other Institutional Uses	AP	AP	AP	AP
<b>PERSONAL SERVICES:</b>	Bail Bonds	N	C <sup>(f)</sup>	N	N
	Basic Personal Services (barber/beauty shop, catering (w/o trucks), diet center, dog/cat grooming, dry cleaner, house cleaning service, locksmith, mailbox rental, nail/manicure shop, repair shop for small appliances or electronic equipment, bicycles, tailoring, shoe repair, tanning salon, travel agent, or veterinary clinic	Y	Y	Y	Y

Downtown Planned Development District (PD-30)

**TABLE 1 - Uses in the Commercial and Mixed Use Districts**

		<b>Promenade District</b>	<b>Downtown Core District</b>	<b>Downtown Mixed Use District</b>	<b>East Village Mixed Use District</b>
	Fitness Center/Health Club, Dance/Karate Studio	Y	Y	Y	Y
	Fortune-Telling	C	C	C	C
	Gun Repair Shop	N	N	N	N
	Laundromat	N	N	AP	AP
	Laundry (commercial customers)	N	N	N	N
	Massage Establishment	N	N	N	N
	Massage Therapy	A	A	A	A
	Recycling Center	N	N	N	N
	Recycling Collection Center for cans & bottles (staff attended)	N	N	N	N
	Recycling Containers for cans & bottles (non-attended, see Sec. 21.45.265)	A	A	A	A
	Major Household Appliance Repair Shop (stove, refrigerator, upholstery, lawn mowers, etc.)	N	N	AP	AP
	Self-Storage	N	N	N	N
	Shoe-shine Stand (indoor/outdoor)	A	A	A	A
	Tattoo Parlor	N	N	N	N
	Termite & Pest Control	N	N	N	N

**TABLE 1 - Uses in the Commercial and Mixed Use Districts**

		Promenade District	Downtown Core District	Downtown Mixed Use District	East Village Mixed Use District
<b>PROFESSIONAL SERVICES:</b>	Accounting, Advertising, Architecture, Artist Studio, Bookkeeping, Business Headquarters, Chiropractors, Computer Programming, Consulting, Contracting, Dentistry, Engineering, Insurance, Law, Marketing, Medicine, Photography, Professional Care Providers (MFC, MFCC, MSW, Psychiatric Nurses), Psychiatry, Psychology, Real Estate, Tax Preparation or Visitor's Information Center	Y	Y	Y	Y
<b>RESIDENTIAL USES:</b>	Artist Studio with Residence (see Division X for incentives in the East Village Mixed Use District)	N <sup>(h)</sup>	AP	AP	Y
	Caretaker Residence	A	A	A	A
	Group Home (care of six or less)	N <sup>(h)</sup>	Y	Y	Y
	Bonus Density Senior and/or Handicapped Housing (see Sec. 21.52.233)	N	C	C	C
	Community Correctional Re-entry Facility	N	N	N	N
	Special Group Housing (fraternity, sorority, convalescent home, shelter, boardinghouse, dormitory, convent, monastery, residential care facility, etc.)	N	N	C	C
	Single-family or Multi-family Residential (see Division IV)	Y	Y	Y	Y
<b>RESTAURANTS &amp; READY-TO-EAT FOODS:</b>	Restaurants & Ready to Eat Foods without drive-thru lanes	Y	Y	Y	Y

**TABLE 1 - Uses in the Commercial and Mixed Use Districts**

		Promenade District	Downtown Core District	Downtown Mixed Use District	East Village Mixed Use District
	Restaurants & Ready-to-Eat Foods with drive-thru lanes (see Sec 21.52.231)	N	N	N	N
	Outdoor Dining	A	A	A	A
	Vending Carts	AP	AP	AP	AP
<b>RETAIL SALES:</b>	Basic Retail Sales (except uses listed below)	Y	Y	Y	Y
	Building Supply or Hardware Store with lumber, drywall, or masonry (hardware stores w/o lumber drywall or masonry are considered "basic retail")	N	N	N	N
	Auxiliary Flower, Plant, Fruit, or Vegetable Sales (outdoor stand or nursery)	A	A	A	A
	Flower Stand or News Stand	Y(l)	Y(l)	Y(l)	Y(i)
	Gun Shop	N	N	N	N
	Itinerant Vendor	T	T	T	T
	Major Household Appliances (refrigerators/stoves/etc)	AP	Y	Y	Y
	Manufacture of Products Sold on Site	A	A	A	A
	Merchandise Mall, Indoor Swap Meet	N	N	N	N
	Outdoor Sales Events (flea mkts/ swap meet)	C	C	C	C
	Pawn Shops	N	N	N	N
	Superstore (Retail > 100,000 SF with > 10% non-taxable merchandise - see 21.15.2985)	N	N	N	N
	Thrift Store, Used Merchandise	N	N	C	C

Downtown Planned Development District (PD-30)

<b>TABLE 1 - Uses in the Commercial and Mixed Use Districts</b>					
		<b>Promenade District</b>	<b>Downtown Core District</b>	<b>Downtown Mixed Use District</b>	<b>East Village Mixed Use District</b>
	Vending Machines	A	A	A	A
<b>TEMPORARY LODGING:</b>	Bed & Breakfast Inn	AP	AP	AP	AP
	Hotel/Motel (more than 90 rooms)	Y	Y	C	C
	Hotel/Motel(less than 90 rooms)/ and youth hostels	C	C	C	C
<b>TEMPORARY USES:</b>	Carnival, Event, Fair, Trade Show, etc.	T	T	T	T
	Construction Trailer	T	T	T	T
<b>TRANSPORTATION AND COMMUNICATION FACILITIES:</b>	Transportation Facilities (bus terminals, cab stands, heliports, helistops)	N	C	C	C
	Electrical distribution station	N	C	C	C
	Cellular and Personal Communication Service				
	a. Freestanding monopole (see 21.52.110)	N	N	N	N
	b. Attached/roof mounted (see 21.45.115)	Y	Y	Y	Y

Endnotes to Table 1

- (a) The following alcoholic beverage sales may be exempted from the conditional use permit requirement:
1. Restaurants with alcoholic beverage service only with meals. This generally means any use with a fixed bar is not exempt. A service bar is not considered a fixed bar. A sushi bar, where alcoholic beverages are served at the same bar where meals are served, is considered serving alcoholic beverages only with meal service. A cocktail lounge without a bar, but with primarily service of only hors d'oeuvres and alcoholic beverages is not exempt. Any restaurant with more than 30 percent of gross sales consisting of alcoholic beverages shall lose its exemption and be required to obtain a conditional use permit to continue to sell alcohol.
  2. Department store or florist with accessory sale of alcoholic beverages.
  3. Grocery stores of 20,000 sq. ft. or greater with accessory sale of alcoholic beverages.

## Downtown Planned Development District (PD-30)

- (b) In the Promenade and Downtown Core District, auto detailing is permitted as an Administrative Use in parking structures only.
- (c) In the Downtown Core District, limousine service and car rental agencies are permitted as accessory uses to a hotel. If such uses are not accessory to a hotel, an Administrative Use Permit is required.
- (d) Surface parking lots in the Promenade and Downtown Core District shall be limited to interim uses.
- (e) City Council hearing is required for new and transferred business licenses.
- (f) Permitted as an accessory use to an office building.
- (g) Massage therapy as a nonadult entertainment business shall be limited to an accessory use for a physician, chiropractor, health club, beauty salon, or hotel over one hundred (100) rooms.
- (h) Conversion of existing non-residential Historic Landmark buildings to residential use is permitted (see Division IX).
- (i) Requires special permit (see Section 21.45.135)
- (j) A social service office is defined as an office maintained and used as a place of business conducted by persons or entities engaged in offering on-site group counseling, treatment or recovery programs, but wherein no overnight care for patients or clients is given. For the purpose of this definition, "group" means three or more persons.
- (k) Permitted as an accessory use only to a grocery store of 10,000 square feet or greater
- (l) Permitted only as a Conditional Use within 600 feet of a police station, jail facility, or court facility.

**C. Setbacks/Required Ground Floor, Pedestrian-oriented Uses**

Map 2 "Downtown PD District - Building Setbacks" indicates the three types of street frontage within the Downtown Planned Development area. These three types of frontages are as follows:

- Frontages requiring a zero setback and ground floor, pedestrian-oriented uses. Along these street frontages new buildings must be constructed at the street property line(s) and the ground floor of new buildings must have pedestrian-oriented uses.
- Frontages with zero setbacks that are subject to development standards, but which do not require ground floor, pedestrian-oriented uses. Along these street frontages, new buildings must be constructed at the property line(s), subject to specific development standards.
- Frontages that require a ten foot or fifteen foot building setback. Along these frontages a landscaped setback is required between a new building and the street property line.

Development standards for each of the three types of street frontages follow.

**1. Frontages requiring a zero setback and ground floor pedestrian-oriented uses**

New development in these areas, as indicated on Map 2, must incorporate pedestrian-oriented uses on the first level. Pedestrian-oriented uses are defined as follows:

- Restaurants & ready-to-eat foods
- Retail sales
- Personal service uses
- Bars/Cocktail lounges
- Lobbies of: hotels, office buildings, residential developments, movie/live theaters, or of any other entertainment uses
- Public plazas and outdoor dining areas.

Development standards for frontages with zero setbacks and pedestrian oriented uses are:

- a. **Required Pedestrian-oriented Uses.**  
Pedestrian-oriented uses shall occupy at least 60% of the ground floor building frontage on streets where active pedestrian uses are required.
- b. **Required Zero Building setback.**



Downtown Planned Development District (PD-30)

At least 60% of the ground floor building frontage shall be constructed with a zero setback on streets where pedestrian-oriented uses are required. Arcades and colonnades built with a zero setback can be used to satisfy this requirement.

If the remaining portion of the ground floor of a building is setback, it shall not be more than 20' in length nor setback more than 12' from the property line.

- c. Arcades and Colonnades.  
The clear width of the walkway between the columns and the building wall shall be a minimum of 8 feet.
- d. Display/Clear Window Requirement.  
Clear, non-reflective display windows/doors shall comprise at least 60% of the ground floor street facade of pedestrian-oriented uses. The maximum height of the bottom sill of required display windows shall not exceed 30" above the adjacent sidewalk. The minimum head height for storefronts and windows at the ground floor should be 80 inches above the adjacent sidewalk.



- e. **First Floor Elevation.**  
The first level of buildings which require ground floor pedestrian-oriented uses shall have a floor elevation which approximates the elevation of the adjacent sidewalk.
- f. **Vehicular Driveway Access.**  
Vehicular driveway access is prohibited along frontages which require pedestrian-oriented uses. Access shall be taken via the alleys serving the site or, on corner lots, the street frontage which does not require active ground floor uses. This requirement may be waived through the Site Plan Review process if necessary (see Division XI).

- g. **Awnings and Canopies.**  
Encroachments such as awnings, canopies and marquees are encouraged. The minimum vertical clearance between the ground or street level and the encroachment should be 10 feet. Horizontal dimensions should relate to the bays of the building facade. The awning/canopy may encroach over the public sidewalk provided at least two feet of clearance is maintained from the street curblane. For awnings and canopies, the materials, shape, rigidity, reflectance, color, lighting, and signage, should relate to the architectural design of the building.

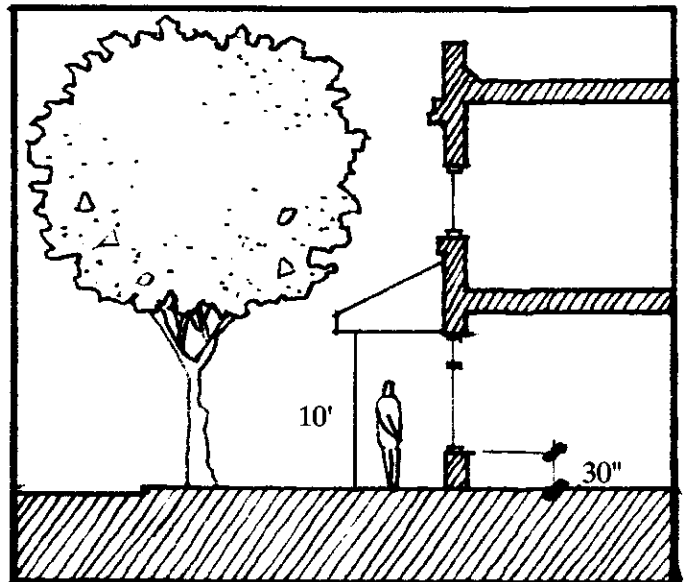

- h. **Entrances Facing the Street.**  
Entrances to uses on ground and upper floors must open onto the public right-of-way. Entrance doors should be setback at least three feet from the property line.

**2. Frontages with required zero building setback subject to standards**

These frontages require a zero setback subject to the design guidelines listed below. The purpose of these standards is to provide an urban downtown environment with the best possible streetscape for pedestrians. One of the primary purposes of the standards is to avoid the construction of large expanses of blank wall adjacent to sidewalks and street frontages. The development standards for these frontages are as follows:

a. Required Zero Building setback.

At least 60% of the ground floor building frontage shall be constructed with a zero setback. Arcades and colonnades built with a zero setback can be used to satisfy this requirement.

If the remaining portion of the ground floor of a building is setback, it shall not be more than 20' in length nor setback more than 12' from the property line.

b. Arcades and colonnades.

The clear width of the walkway between the columns and the building wall shall be a minimum of eight feet.

c. Building Base.

The base of the building (the first 2'- 5' above the sidewalk) should be differentiated from the rest of the building facade with treatments such as change in material and/or color, mouldings, or built planters.

d. Building Bays.

The maximum width of a bay of blank wall, without a feature in relief or protrusion of at least 6 inches, should not be more than 25 feet. Pilasters, mouldings recessed wall panels or display features should be used to create visual bays on the street level building wall.

e. Windows.

Walls on each building at the street should have glazed opening at least every 40 feet. The plane of window glass relative to a primary building wall plane should be separate by at least 6 inches, and the sills should not be higher than four feet above the sidewalk.

f. Awnings, Canopies and Marquees.

Awnings, canopies and marquees are encouraged. The minimum vertical clearance between the ground or street level and the encroachment should be 10 feet; horizontal dimensions should relate to the bays of the building facade. The awning/canopy may encroach over the public sidewalk provided at least two feet of clearance is provided from the street curbline. For awnings and canopies, the materials, shape, rigidity, reflectance, color, lighting, and signage, should relate to the architectural design of the building.

g. Entrances Facing the Street.

Entrances to uses on ground and upper floors should open onto a public right-of-way. Entrance doors should be setback at least 3 feet from the property line.

h. Landscaping.

Landscaping at the building wall is permitted, provided the planter is part of the building facade and the earth level for planting is at a level of at least one foot above sidewalk level. Recesses, bases and projections can be employed if the setback for landscaping is not more than 5 feet.

**3. Frontages with Required Ten or Fifteen foot Building Setbacks**

Map 2 establishes street frontages where either a 10' or 15' building setback is required for new buildings. No structures, including subterranean and semi-subterranean parking garages, may be constructed in the required setbacks except for those projections described below:

a. For the following street frontages,

- Pacific Avenue from 3rd Street to 7th Street,
- Broadway from Golden Avenue to Pacific Avenue, &
- 3rd Street from Golden Avenue to Pacific Avenue:

- 1) Surface parking lots may be built within the setback provided a continuous 6' wide landscaped area is maintained between the parking lot and the street property line.
- 2) Treatment of the ground plane within the setback may be either planting or hardscape.
- 3) New buildings are to be built at the required setback line along at least 60 percent of the building facade.

- 4) Projections are permitted into the required setbacks in accordance with those permitted in the Commercial Zoning Districts (see Section 21.32.220 C)
- b. For all other street frontages:
  - 1) Surface parking lots may be built within the setback provided a continuous 6' wide landscaped area is maintained between the parking lot and the street property line.
  - 2) Treatment of the ground plane within the setback must be landscaped with planting.
  - 3) Projections are permitted into the required setbacks in accordance with those permitted in the Commercial Zoning Districts (see Section 21.32.220 C).

The setback requirement may be waived through the Site Plan Review process if the project design meets the intent of the development standards listed in Division XI.

**4. Interior setbacks (for high-rise buildings, see section M of this Division for additional requirements)**

- a. Setbacks from an alley - 10 feet from alley centerline
- b. Setbacks from an interior property line:
  - Commercial buildings - 0'
  - Residential buildings - 5'

**5. Corner cut-off**

At corners of properties at street intersections, intersections of streets and alleys and at intersections of driveways and property lines, new construction shall not be permitted in such a manner that it significantly impedes visibility between heights of 2 feet and 7 feet above the ground in a corner cut-off of at least 6 feet by 6 feet. One vertical support element such as a column is permitted in the corner area, if the cross-section of the element fits within a circle with a diameter of 18 inches. This requirement may be waived through the Site Plan Review process if the Director of Public

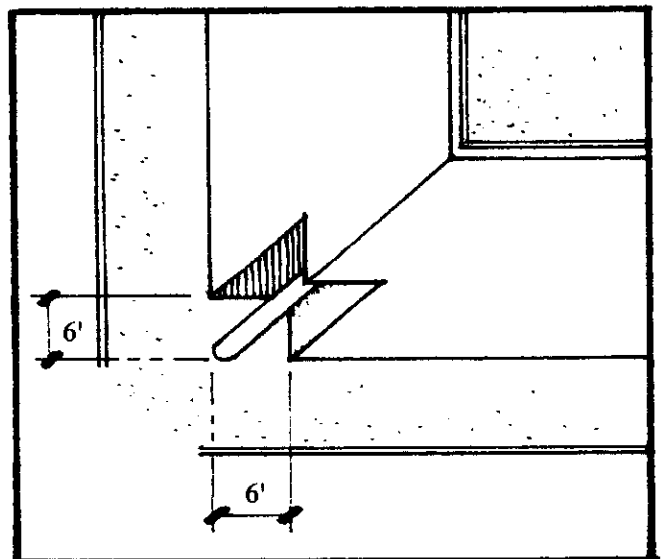

Works finds that the cut-off is not necessary for traffic safety.

**D. Promenade Development Standards**

These standards apply to the portion of the Promenade between Ocean Boulevard and 3rd Street.

**1. Promenade development objectives**

These objectives are intended to serve as the guide for the establishment of a master plan for development and use of The Promenade and the adjacent properties.

- a. Uses along the Promenade should create a high quality, attractive pedestrian environment. Business and commercial activities should add charm, excitement, vitality and diversity. Private and public uses along the promenade should generate day and night activity that is oriented to the pedestrian. These activities may include outdoor dining, retail sales, public markets, arts and crafts, shows and other similar uses.
- b. The predominant role of the Promenade is as a pedestrian mall. Automobile traffic for the general public is not permitted; vehicular traffic for emergency vehicles is provided on the Promenade.
- c. The form of the built environment and the public spaces created should enhance the character of the pedestrian environment of the Promenade. Buildings should incorporate human-scale design ideas and should establish edges that help to define usable public spaces.
- d. The Promenade should provide a strong physical link between the downtown commercial districts and Queensway Bay. Consistent streetscape treatments should be used in both areas, including paving, lighting, banners and street signs.
- e. Private development should be allowed to use part of the public right-of-way of the Promenade. However, such development shall not occur until after a master plan for development of the Promenade is approved by the Redevelopment Agency, Planning Commission and City Council. The portion of the development projected into the right-of-way shall be low-scale (2 stories) and balanced with the addition of new public spaces (such as providing a public pedestrian linkage from The Promenade to Pine Avenue or new plazas) in order to retain the pedestrian atmosphere which makes The Promenade a unique place.

**2. Promenade development standards**

Development along The Promenade shall adhere to the following standards:

- a. Development along The Promenade shall occur in accordance with a Master Plan. The Promenade Master Plan shall be approved by the Redevelopment Agency, Planning Commission and City Council.
- b. The existing right-of-way of the Promenade is 80 feet. Proposals for development along the Promenade that include encroachment into the right-of-way must be consistent with The Promenade Master Plan and the development objectives of The Promenade.
- c. Access for trams and for emergency vehicles shall be a minimum of twenty (20) feet in width, centered on the centerline of The Promenade. No development shall be permitted within this twenty (20) feet right-of-way.
- d. The projection into the existing right-of-way shall be limited to a maximum of thirty (30) feet (either from one side or both sides) into the eight (8) feet total right-of-way width, if and only if the following are met:
  - There is a minimum of fifty (50) feet of continuous right-of-way width at all points along The Promenade; and
  - There is additional public plaza to be created to balance the projection. Such encroachment may be a maximum of two (2) stories and not more than thirty-five (35') feet in height to the top of the roof.
- e. Development along The Promenade shall conform to the development standards in Division III. C.1. (Frontages with zero setbacks with required active pedestrian-oriented uses).
- f. The landscaping within the Promenade right-of-way, including the four rows of trees, can be altered only after an alternative streetscape plan is reviewed by the Joint Review Authority (the Redevelopment Agency and Planning Commission), and approved according to the process in Division XI Development Approval Procedures.

**E. Maximum Building Height.**

Map 3 establishes the maximum permitted building height in both feet and stories. Elevator and mechanical equipment penthouses shall not be included in the measurement of building height. Additionally, the following roof-mounted structures may exceed the permitted building height by up to ten feet:

- Flagpoles
- solar collectors
- patio covers and other roof-top recreational amenities

**F. High-rise Development Standards.**

These standards apply to all high-rise development in the Downtown Planned Development District. For the purposes of this section, high-rise development is defined as buildings with a height of 100' or more.

1. Each building must have a clearly defined base, middle, and top. The base should include the first two to three floors and should relate to the pedestrian environment at street level.
2. The minimum floor to ceiling height for a residential development shall be 9' (this height may be reduced in kitchen, bathroom and closet areas).
3. Where a roof top is to be used for residential common open space, the roof top shall incorporate recreational uses, landscaping and decorative paving materials.
4. On-grade and above-grade parking garages shall be screened in accordance with the Design Standards in Division VIII.

**G. Lot Size.**

The minimum lot size for any new subdivision of existing parcels shall be 10,000 square feet.

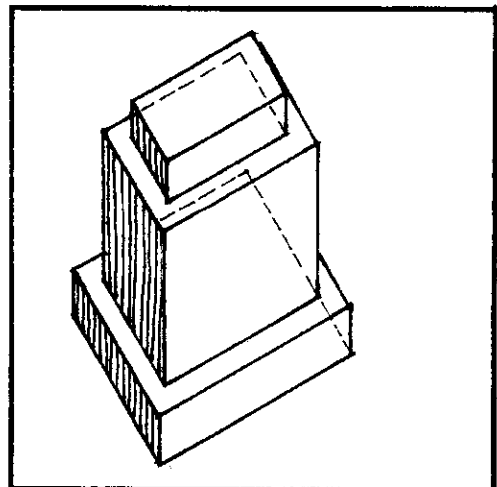



**H. Required Screening**

**1. Rooftop equipment.**

Mechanical equipment on rooftops shall be screened from public view by solid screening devices at least as high as the equipment being screened. In the Promenade District, Downtown Core Mixed Use District and the Downtown Mixed Use District, such equipment shall also be screened from view from higher buildings to the satisfaction of the Director of Planning and Building.

**2. Utility meters and Site Equipment.**

Utility meters and site equipment shall be screened from view from public rights-of-way.

**3. Trash Receptacles.**

Trash areas shall be screened from public view on all sides (see sec. 21.46.080 Accessory Structures for additional requirements). New construction requiring Site Plan review or a Conditional Use Permit shall be required to submit a trash pick-up and trash area maintenance schedule.

**4. Loading Areas**

Product loading and service areas shall be fully screened from view from a public right-of-way.

**I. Signs.**

**1. Permitted signs/Development Standards.**

All signs shall comply with the requirements of Chapter 21.44 (Signs). For properties along Pine Avenue, between Ocean Boulevards and 7th Street, signs must comply with Redevelopment Agency, Pine Avenue Sign Design Guidelines.

**2. Prohibited signs.**

Pole signs and freestanding signs (with the exception of monument signs with a height of 6 feet or less) are prohibited along frontages where zero setback and ground floor uses are required (see Map No. 2). In areas where monument signs are limited to 6' in height, the permitted height may be increased through the Site Plan Review process.

**J. Landscaping Requirements.**

The landscaping requirements of Chapter 21.42 shall apply to all new development. All new developments shall be required to provide street trees in the abutting parkway/sidewalk areas. The suggested species of street trees are specified in Appendix A. Alternative species may be approved by the Director of Planning and Building. The determination of the Director of Planning and Building may be appealed to the City Planning Commission.

**K. Parking and Loading Requirements.**

**1. Required Parking and Loading.**

Parking and loading shall be provided in accordance with the Chapter 21.41 of the Zoning Regulations. This section includes provisions for the reduction in the required number of spaces through participation in the Downtown Parking Management Program.

**2. Downtown Parking Management Program.**

Required parking may be provided through participation in the Downtown Parking Management Program (DPMP). The determination of the number of parking spaces required by the DPMP shall be either the number of spaces required by the Zoning Regulations (after deducting the non-conforming parking rights of the building/lease space) or the number of parking spaces required by the ratios established in the DPMP, whichever is smaller.

**3. Parking Reduction - Historic Landmarks (see Division IX)**

**4. Parking Exemption - Outdoor Dining.**

No additional parking is required for outdoor dining in the PD-30 area.

**5. Parking Exemption – Conversion to Restaurants/Ready-to-Serve Uses in the East Village Mixed Use District.**

In the East Village Mixed Use District restaurants and ready-to-eat food uses that are converted from a previous non-residential use shall not require additional parking.

## **DIVISION IV. RESIDENTIAL DISTRICTS**

### **A. Permitted Uses**

1. Residential Uses.

In addition to residential development, those uses permitted in the R-4-N district shall be permitted. Those uses which are permitted subject to an Administrative Use Permit or Conditional Use Permit shall be subject to the same processes.

2. Commercial uses at arterial intersections.

Sites located at the intersection of arterial streets (the intersections of Magnolia Avenue and 3rd, 6th and 7th Streets) shall permit the commercial uses of the CNP (Neighborhood Commercial, Pedestrian-oriented) zoning district.

3. Reuse of Historic Landmarks (see Division IX).

### **B. Permitted Density**

Permitted density is based on lot size (except in the Downtown Core Area, where the height of proposed buildings may also effect the density permitted). Tables 2 and 3 establish the permitted densities in each sub-area. In calculating the number of units permitted on a site, the following shall apply:

1. Net Lot Area.

All densities are calculated on the basis of net lot area (existing lot size minus any required dedications for public right-of-way improvements).

2. Fractional Densities.

Fractional densities shall not be counted in determining the number of units allowed on the site.

3. Exceptions.

The following uses shall not be subject to the maximum densities set forth by Tables 2 and 3:

Downtown Planned Development District (PD-30)

- a. Conversion of non-residential Historic Landmark Buildings.  
Through the Conditional Use Permit process, non-residential Historic Landmark buildings can be converted to residential uses. See Division IX.
- b. Conversions of non-residential buildings to live/work spaces in the East Village Mixed Use District and East Village Residential District (see Division X).

<b>TABLE 2 - Downtown Planned Development Area - Permitted Residential Density</b>				
Sub-Area	Lot Area of 0-4000 sf	Lot Area of 4001-7,500 sf	Lot Area of 7501-15,000 sf	Lot Area of 15,001 sf or larger
Promenade (6 stories or less)	1 unit	1 unit per 1,400 sf (31 units/acre)	1 unit per 800 sf (54 units/acre)	1 unit per 453 sf (96 units/acre)
East Village Residential	1 unit	1 unit per 1,400 sf (31 units/acre)	1 unit per 1,400 sf (31 units/acre)	1 unit per 1,000 sf (43 units/acre)
East Village Mixed Use	1 unit	1 unit per 1,400 sf (31 units/acre)	1 unit per 1,200 sf (36 units/acre) or 1 unit per 800 sf (54 units/acre)*	1 unit per 900 sf (48 units/acre) or 1 unit per 580 sf (75 units/acre)*
West End Residential	1 unit	1 unit per 1,400 sf (31 units/acre)	1 unit per 1,000 sf (43 units/acre)	1 units per 800 sf (54 units/acre)
Downtown Mixed Use	1 unit	1 unit per 1,400 sf (31 units/acre)	1 unit per 1,000 sf (43 units/acre) or 1 unit per 800 sf (54 units/acre)*	1 units per 800 sf (54 units/acre) or 1 unit per 580 sf (75 units/acre)*
Downtown Core (6 stories or less)	1 unit	1 unit per 1,400 sf (31 units/acre)	1 unit per 800 sf (54 units/acre)	1 unit per 453 sf (96 units/acre)

\* Higher density allowed only for developments at least four stories in height. See attached "Height District" Map.

<b>TABLE 3 - Downtown Core Sub-Area - Permitted Residential Density</b>			
	<b>Buildings with 6 stories or less</b>	<b>Buildings of 7 stories to 150'</b>	<b>Buildings over 150' in height</b>
<b>Downtown Core Sub-area</b>	See Table 2	1 unit/315 sf (138 units/acre)	no maximum* see High Rise Development Standards in Division III.
<b>Promenade Subarea</b>	See Table 2	1 unit per 315 sf (138 units/acre)	Not applicable

**C. Maximum Building Height.**

Map Number 2 establishes the maximum permitted building heights in both feet and stories. No structures can exceed these limits except for the following:

- Elevator and mechanical equipment penthouses
- Additionally, the following structures may exceed the permitted building height by up to ten feet:
  - Flagpoles
  - solar collectors
  - patio cover and roof-top recreational amenities

**D. Setbacks**

**1. Street setbacks.**

Map Number 2 establishes areas where either a 10' or 15' building setback is required. No structures may be constructed in these setbacks except for those described in the "Permitted projections into required setbacks/setback averaging" section below.

Semi-subterranean and subterranean parking garages must comply with the required building setbacks.

**2. Interior setbacks**

- a. Setbacks from an alley - 15 feet from alley centerline
- b. Setbacks from an interior property line - 5'

**3. Permitted projections into required setbacks/setback averaging.**

- a. **Permitted Projections.** The projections permitted into the required setbacks shall be those permitted in the R-4-N Zoning Districts (see section 21.32.220 C).
- b. **Setback Averaging.** For those areas where either a 10' or 15' minimum setback is required, portions of the building may project up to 5' into the setback provided an average setback of 10' (in areas requiring a 10' minimum setback) or 15' (in areas requiring a 15' minimum setback) is maintained.

**4. Fence/wall Locations**

Fences and garden walls are not permitted within required street setbacks except for wrought iron/tube steel fences which may be permitted through the Site Plan Review process.

**5. Corner cut-off**

At corners of properties at street intersections, intersections of streets and alleys and at intersections of driveways and property lines, new construction shall not be permitted in such a manner that it significantly impedes visibility between heights of 2 feet and 7 feet above the ground in a corner cut-off of at least 6 feet by 6 feet (measured from the intersection of the property lines or the intersection of a driveway and a property line). One vertical support element such as a column is permitted in the corner area, if the cross-section of the element fits within a circle with a diameter of 18 inches. This requirement may be waived through the Site Plan Review process if the Director of Public Works finds that the cut-off is not necessary for traffic safety.

**E. Location of On-Grade Parking Garages**

On-grade garages must be screened on street sides by residential units, the building entrance lobby or other portions of the building. The screening requirement may be waived through the Site Plan Review process if the garage wall is architecturally integrated into the design of the upper floors and/or raised landscaped planting is provided which visually reduces the height of the garage.

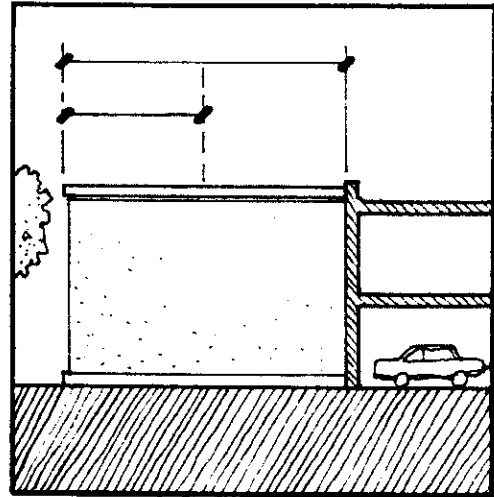

**F. Dwelling Unit size.**

The minimum unit size for any dwelling unit shall be 450 square feet. The average unit size in each residential development shall be a minimum 900 square feet. Not more than 15% of the total units within a project may be zero bedroom studio apartments.

The Planning Commission may reduce the minimum unit size requirement for development of restricted senior housing or other special group residences.

**G. Lot Size**

The minimum lot size for any new subdivision shall be 10,000 sq. ft.

**H. Privacy Standards.**

Table 4 establishes the privacy requirements for residential development. The primary room window is defined as the largest window in the living room or combined living/dining room. The measurements shall be taken on a "line-of-sight" basis. Where there is determined to be no line-of-sight, the distance requirements shall not apply.

<b>TABLE 4 - Residential Privacy Standards</b>				
	Primary window of other units	Public corridor or walkway	Front or side street property line	Interior side/rear property line or blank wall
Required distance from primary room window to:	40 feet	8 feet	10 feet	15 feet

**I. Residential Amenities.**

Residential developments consisting of 20 or more units shall provide a common recreation/meeting room or rooms. Additionally, developments consisting of 20 units or more shall provide storage cabinets or storage rooms and/or bicycle storage areas to the satisfaction of the Director of Planning and Building.

**J. Open Space.**

A minimum of 150 square feet of usable open space per residential unit shall be provided. Of this 150 square feet, 50% shall be provided as private open space and 50% shall be provided as common open space. The design of the open space shall comply with the open space requirements of the R-4-N district (Section 21.31.230 of the Zoning Regulations). Common open space may include, but is not limited to: roof-top decks, exercise rooms, court game areas, tot lots and swimming pools and spas.

**K. Landscaping Standards.**

The landscaping requirements of Chapter 21.42 shall apply to all new development. All new developments shall be required to provide street trees in the abutting parkway/sidewalk areas. The suggested species of street trees are listed in Appendix A. Alternative species may be approved by the Director of Planning and Building. The determination of the Director of Planning and Building may be appealed to the City Planning Commission.

**Special Standards - 4th and 5th Streets.**

These streets provide the east/west pedestrian linkages from the East Village and West End neighborhoods. To emphasize these linkages, the landscape treatment along these streets shall incorporate a double rows of trees consisting of street trees planted in the public right-of-way and trees planted in the adjacent yard setback (2 feet from the property line) as illustrated below. The trees planted in the yard setback shall be in the same species as the street trees and planted in such a manner as to provide a continuous canopy.



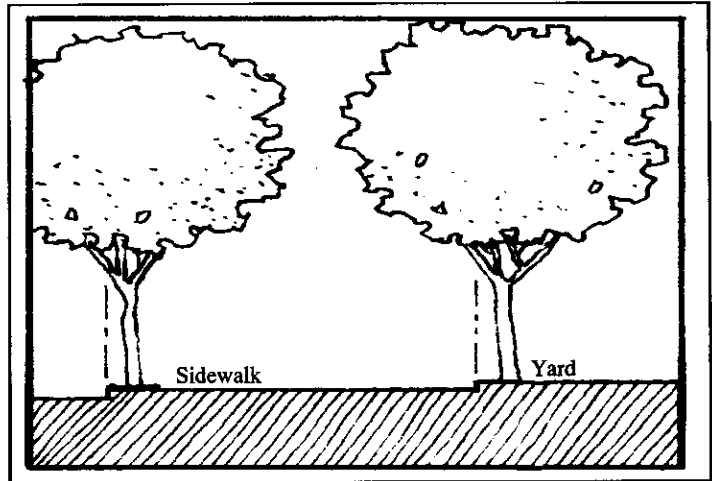
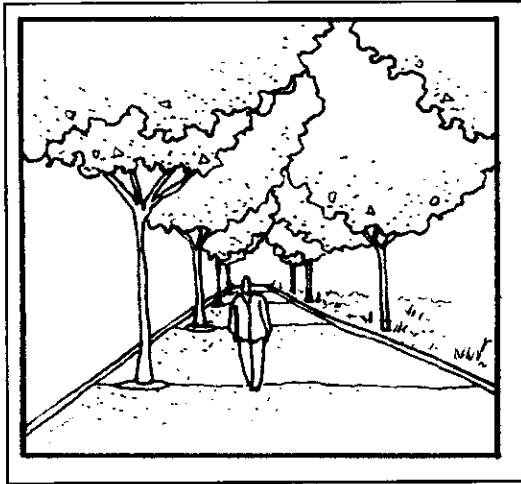

**L. Required Screening.**

1. Rooftop equipment. All mechanical equipment on rooftops shall be screened from public view by solid screening devices at least as high as the equipment being screened.
2. Utility meters. All utility meters shall be fully screened from view from public rights-of-way.
3. Trash Receptacles. All trash areas shall be screened from public view on all sides. See Section 21.46.080 (Accessory Structures) for additional requirements.

**M. Parking Requirements.**

The parking requirements of Chapter 21.41 of the Zoning Regulations shall apply, except that tandem parking shall be permitted for residential uses subject to the following:

1. Tandem parking may only be used for projects consisting of 20 units or more.
2. Tandem parking may only be used to satisfy the parking requirements for 1-bedroom units (in lieu of providing 1.5 spaces per unit).

## **Division V. Park District**

This district applies to the public park on the west side of Golden Avenue. Should it be possible in the future to acquire additional parkland in the Downtown, this Division will be amended to incorporate these additional areas.

### **A. Permitted Uses/Development Standards.**

All new uses and development shall comply with the provisions of Chapter 21.35 (Park District)

### **B. Parking Requirements**

The number of parking spaces required shall comply with the provisions of Chapter 21.41 (off-street parking requirements). The required parking for the park shall consist of those parking spaces provided on-site as well as those curbside parking spaces on either side of the streets adjacent to the park.

### **C. Master Plan Required.**

Prior to the commencement of construction, a Master Site Plan shall be submitted for the review and approval of the Planning Commission.

## **Division VI. Institutional/Government District**

### **A. Permitted Uses.**

The uses permitted in the Institutional/Governmental District shall comply with the provisions of Chapter 21.34 (Institutional District) of the Zoning Regulations.

### **B. Maximum Building Height.**

Map number 3 establishes the maximum permitted building height in both feet and stories. No structures can exceed these limits except for the following:

- elevator and mechanical equipment penthouses

Additionally, the following structures may exceed the permitted building height by up to ten feet:

- flagpoles
- solar collectors
- patio cover and roof-top recreational amenities

### **C. Setbacks/Street Frontage Treatment**

1. **Street Setbacks.** Map Number 2 indicates the three types of street frontages within the Downtown Planned Development area. The requirements for these types of frontages are described in Division III (Commercial and Mixed-Use Districts), Section C.

2. **Interior Setbacks**

Setback from an interior property line - 5'

Setback from an interior property line abutting an alley - 10' from alley centerline.

### **D. High-rise Development (buildings with a height of 100' or more) Performance Standards**

High-rise development in this district shall comply with the High-rise standards in Division III. of this document.

### **E. Lot Size**

The minimum lot size for any new subdivision of existing parcels shall be a minimum of 10,000 square feet.

**F. Required Screening**

**1. Rooftop equipment.**

All mechanical equipment on rooftops shall be screened from public view by solid screening devices at least as high as the equipment being screened.

**2. Utility meters and Site Equipment.**

All utility meters and site equipment shall be fully screened from view from a public right-of-way.

**3. Trash Receptacles.**

All trash areas shall be screened from public view on all sides. See Section 21.46.080 (Trash Receptacles) for additional requirements.

**4. Loading Areas**

Product loading and service areas shall be fully screened from view from a public right-of-way.

**G. Signs.**

Signs shall comply with the requirements of Chapter 21.44 (Signs).

**Prohibited signs** - Pole signs and freestanding signs (except monument signs less than six feet in height) shall be prohibited in areas where zero setbacks are permitted. Monument signs in excess of 6' can be permitted through the Site Plan Review process.

**H. Landscaping Requirements.**

The landscaping requirements of Chapter 21.42 shall apply to all new development. All new developments shall be required to provide street trees in the abutting parkway/sidewalk areas. The suggested species of street trees are listed in Appendix A, alternative species can be approved through the Site Plan Review Process.

**I. Parking Requirements.**

The parking requirements of Chapter 21.41 of the Zoning Regulations shall apply.

## **Division VII. Public Improvement Requirements**

### **A. Off-site Improvements.**

Developers shall comply with the requirements of Chapter 21.47 (Dedication, Reservation and Improvement of Public Rights-of-way). These improvements include repair of off-site infrastructure including curbs, sidewalks and driveways; the installation of street trees and planting of parkway strips; and in some cases, dedications to widen adjacent substandard alleys and streets.

### **B. Pedestrian Linkage Requirements - Fourth and Fifth Streets**

Specific landscaping requirements apply to the properties fronting of Fourth and Fifth Streets. Division IV, Section K illustrates the required parkway and on-site landscaping treatment along these streets.

### **C. Public Art.**

In the Downtown Redevelopment Project Area, projects must comply with the Percent for Public Art Program. This program requires that developers expend a minimum of one percent (1%) of the total development costs on the Art in Public Places Program. Additional information regarding this program can be obtained from the Redevelopment Agency.

### **D. West Gateway Master Plan.**

In the West Gateway project area, all new development requiring Site Plan Review shall improve the abutting public right-of-way in accordance with the West Gateway Master Plan adopted by the Long Beach Redevelopment Agency. Off-site public improvements includes, but is not limited to, special pavement treatment, pedestrian bulb-outs, and street trees.

## **Division VIII. General Development Standards**

### **A. Intent**

The development standards set forth in this Division are general and apply to all buildings in the PD-30 area including both new construction and renovation projects. These standards are intended to guide all private and public parties involved in design and development to achieve the highest quality of built environment in greater downtown Long Beach. The buildings, streetscape and landscape of the downtown should enhance the stature of Long Beach as a city of international significance.

### **B. Building Siting & Public Art**

1. Buildings should be sited to help define street space and public open spaces, in order that streets and public spaces are as active and safe as possible.
2. When public spaces are part of a development, they should be accessible and visible from a public street.
3. Siting of buildings should allow and encourage public access that is active and safe along public rights-of-way and on the development site.
4. Primary building entrances should face public streets.
5. Art work provided through the Percent for Public Art Program (Division VII, Section C. Public Art) should be visible from public streets and/or public open spaces.
6. Acceptable forms of public art may include aspects of streetscape design, in accordance with the City's public art program.

### **C. Building Servicing and Equipment**

1. Servicing of new and renovated buildings, including garbage and deliveries, should occur on mid-block alleys whenever possible, not along street frontages. Developments occupying entire blocks may eliminate mid-block alleys only if an alternative and equivalent means of mid-block servicing is provided.

2. Servicing of new and renovated buildings, including trucks, loading docks and loading operations, should be minimally visible and audible from public streets. Roll down doors, screening, enclosures and other devices, in addition to an operational program, should be employed to minimize visibility and audibility of building servicing.
3. Mechanical, plumbing, sprinkler and electrical equipment for new and renovated buildings should be minimally visible on roofs or at ground level from public streets and from public spaces.

**D. Building Design**

1. Buildings should be designed to reflect the proportions and measurements of people, should have human scale, especially on the ground level.
2. Building exterior design should incorporate three dimensional elements to articulate facades and mass, to create plays of light and shadow, and to add interest to the building appearance.
3. Public streetscape should be enhanced through exterior building design; building and landscape elements of developments should address frontages of public streets.
4. Where possible, building exteriors along public streets should include active pedestrian uses, entrances, arcades and colonnades; where not possible, building exteriors along public streets should include landscaping and other pedestrian level building treatments.
5. Exterior materials of buildings should be high quality, durability and permanence. Exterior high quality masonry materials are encouraged, such as stone, brick and terra cotta for non-residential developments.

**E. Residential Development**

1. Residential development should provide the highest quality living environments, including usable open spaces, substantial storage space, natural light and ventilation, and provisions to ensure safety for residents.
2. Dwellings should have windows and openings which allow views to open spaces and public ways, and which provide the best natural light and ventilation for living.
3. Multi-family residential development should provide adequate and dedicated bicycle parking/storage areas.

**F. Development With and Adjacent To Historic Buildings**

1. Existing historic buildings are important visual and cultural resources for downtown Long Beach. Buildings that are determined to be historic should be used as references for the design of adjacent new buildings in form, materials and quality.
2. New buildings should be designed in relation to adjacent historic buildings, including elements such as siting, setbacks, entrances, form, height, materials, colors, fenestration, facade and roof elements.

**G. Parking Structures**

1. Where possible, the ground level of parking structures along public streets should include active pedestrian uses, entrances, arcades and colonnades; where not possible, the ground level of facades along public streets should include landscaping and other pedestrian level building treatments.
2. Parking structures which serve primarily a building or a group of buildings in a development should be compatible in architectural treatment with the architecture of the served building(s).
3. Ramps, cars and sources of artificial lighting in parking structures should be minimally visible from public streets and open spaces.



## **Division IX. Preservation of Historic Structures**

### **A. Landmark Buildings.**

The Downtown area contains a number of buildings which have been designated as City Historic Landmarks. A complete list of designated landmark buildings can be found in Chapter 16.52 of the Long Beach Municipal Code. [Note: Updated information on landmark status of buildings can be obtained from the Historic Preservation Officer.]

### **B. Alterations to Landmark Buildings**

Exterior Alterations - Applications for exterior changes to designated historic landmarks must obtain a Certificate of Appropriateness from the Cultural Heritage Commission. Exterior changes subject to Cultural Heritage Review include:

1. Additions
2. Remodeling (exterior only)
3. Relocations
4. Demolitions
5. Exterior painting or other re-surfacing
6. Exterior signs
7. Window alterations
8. Awnings

Interior alterations -Interiors may be subject to Certificate of Appropriateness review if they are publicly accessible and architecturally significant. If the interior was an element of the designation, it will appear in the designation ordinance for the building.

### **C. Re-use of Landmark Buildings - Incentives**

#### **1. Commercial Uses**

Waiver of Parking for Ground Floor Uses.

The ground floor of existing landmark buildings may be converted to restaurant, retail or entertainment use without providing additional parking.

#### **2. Conversion to Residential Use - Waiver of Density Standards.**

The Planning Commission may waive all density limits through a Conditional Use Permit provided new construction is not included in the area where density is waived and the use provides traditional residential units and not single-room occupancy hotel rooms.

**3. Conversion of a Residential use to a Commercial Use**

A residential landmark building located in the West End Residential District or the East Village Residential District may be converted to a commercial use through the Administrative Use Permit process.

**4. State Historical Building Code**

A state code exists for the rehabilitation of designated historic buildings with regard to building code issues. The intent of the State Historical Building Code is to permit flexibility in meeting the safety intentions of the code while retaining the existing archaic materials and designs inherent in historic buildings. The rehabilitation of historic buildings is facilitated by allowing code decisions based on performance standards, rather than prescriptive code standards, and is subject to the discretion of the building and fire officials.

## **Division X. East Village Live-Work Provisions**

Intent. Home occupation businesses are currently permitted City-wide, subject to a number of conditions which require that the business activity be clearly accessory to the residential use of the building. This Division does not effect the home occupation provisions nor the ability to convert a non-residential building to traditional residential occupancy. The purpose of this Division to is broaden live-work opportunities for artists and artisans and provide greater flexibility in the use of live-work space by permitting the conversion of existing non-residential buildings in the East Village area.

### **A. Development Standards**

The conversion of existing non-residential buildings to live-work space for artists and artisans shall be permitted, subject to the following standards:

**1. Waiver of Density and open space requirements.**

The density limitations set forth by Division IV. shall not apply to the conversion of existing structures to live-work occupancy.

**2. Minimum Unit Size.**

The minimum unit size for live-work occupancy shall be 750 square feet.

**3. Separate Entrance.**

Each live/work quarters shall have a separate entrance, each unit shall be clearly identified in order to provide for emergency services.

**4. Unit Design.**

No more than 33 percent of any live/work space shall be used for exclusive residential purpose such as sleeping area, kitchen, bathroom and closet areas. The unit shall provide as a minimum, full cooking and bathing facilities.

**5. Building Permits.**

All necessary building permits shall be obtained prior to the use of the space for residential occupancy.

**6. Mezzanine Additions.**

Mezzanine space may be added to live-work units without providing additional parking provided the area of the addition does not exceed 450 square feet per unit.

**B. Uses**

The permitted uses in spaces which are used for combined commercial/residential occupancy, shall be artist studios.

**C. Use Limitations**

1. No mechanical equipment shall be used which generates noise higher than the noise standards established for residential uses (Chapter 8.80 L.B.M.C.).
2. There shall be no outside operations, outside storage or outdoor display of materials or products.
3. No toxic, explosive, flammable, combustible or corrosive materials are stored or used on the site in quantities or in a manner that violates any provision of the Uniform Fire Code. No etiologic or radioactive materials shall be used or stored on the site at any time.
4. No process shall be used which is hazardous to public health, safety or welfare.
5. The home occupation shall not displace or block the use of parking spaces required for the residential use including any business storage in required garage parking areas.
6. Not more than two vehicles shall be used in the business. Only one vehicle may be commercially licensed.
7. The Zoning Administrator may require the discontinuance of a work activity in a live/work unit if he/she finds that as operated or maintained there has been a violation of any applicable condition or standard. The Zoning Administrator shall have the authority to prescribe additional conditions and standards of operation for any category of work activity in a live/work unit.

## **Division XI. Development Approval Process**

### **A. Procedures**

The PD-30 area is unique in that there are two agencies, the Planning Bureau and the Redevelopment Agency, which play a role in reviewing and permitting development proposals.

In reviewing and approving development plans and discretionary permits in the PD area, the City Council, Planning Commission, Redevelopment Agency and/or Site Plan Review Committee shall be guided by the following:

- 1) The goals and policies of the General Plan;
- 2) The Redevelopment Plan;
- 3) The Redevelopment Agency Design Review Process;
- 4) The development and use standards set forth by the Planned Development Ordinance and
- 5) The procedures, development and use standards set forth in Title 21 Zoning of the Long Beach Municipal Code.

### **B. Site Plan Review**

#### **1. Applicability.**

Site Plan Review is required for all non-residential projects consisting of 1,000 square feet or more of new construction (including additions to existing buildings) and for residential projects consisting of 5 units or more of new construction.

### **C. Waiver of Development Standards.**

During the Site Plan Review process, the Planning Commission or Site Plan Review Committee may waive certain development standards. Such relief may only be granted if it is found that the waiver improves project design and the waiver will not degrade the environment or result in any changes to classification of land use or to density.

## Downtown Planned Development District (PD-30)

The development standards which may be waived are limited to:

- residential privacy requirements
- residential open space requirements
- landscaping requirements
- the prohibition against tandem parking in commercial developments (provided the tandem parking utilizes a valet service)
- average unit size for restricted senior citizen development
- screening/setback requirements

### **D. Conditional and Administrative Use Permits**

Divisions I and IV of Chapter 21.25 of the Long Beach Municipal Code establish the procedures for uses requiring a Conditional Use Permit or an Administrative Use Permit.

### **E. Appeal**



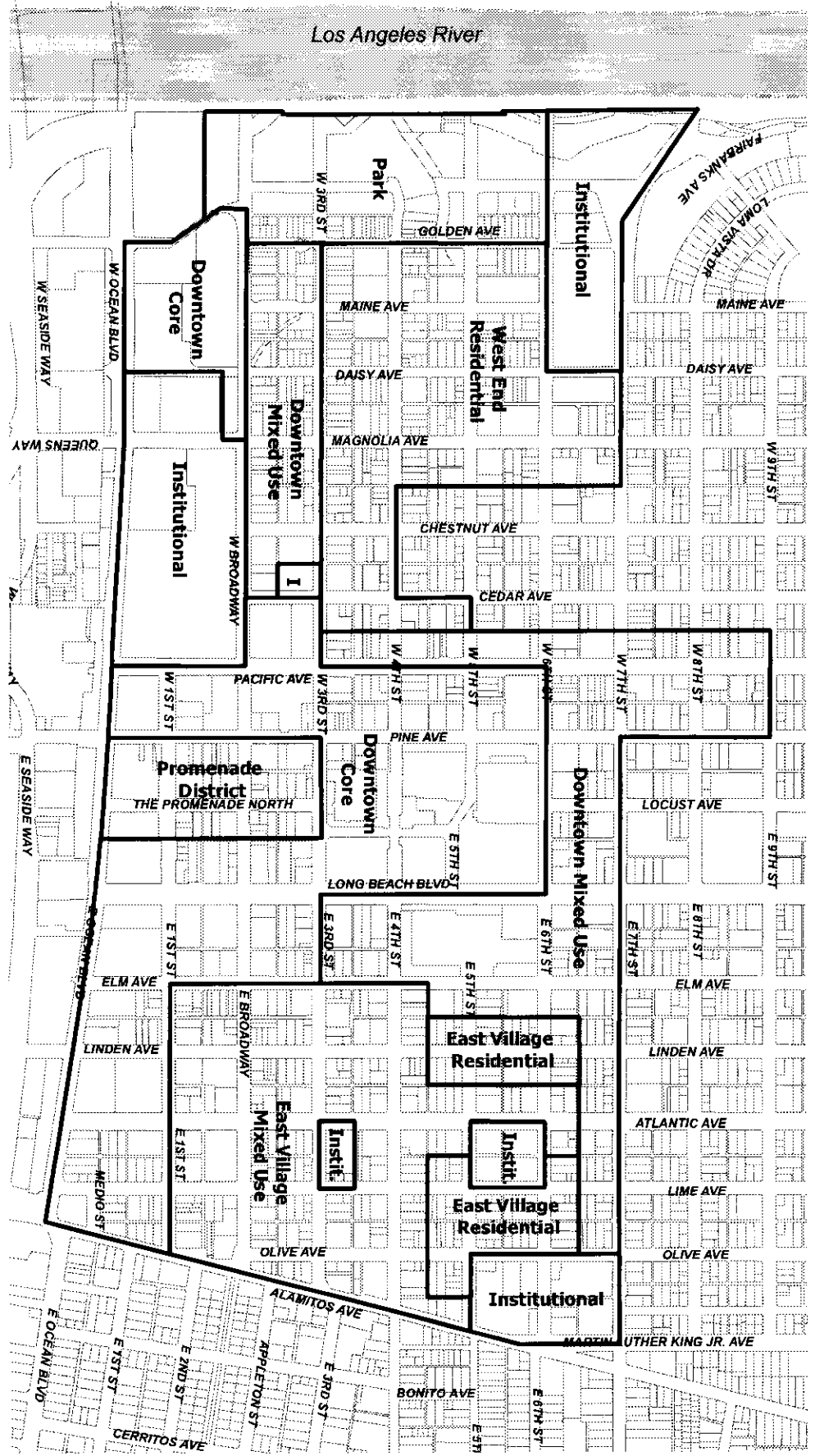

The applicant or aggrieved person may appeal any decision made by the Planning Commission, Site Plan Review Committee or Zoning Administrator. Such appeal shall be processed in accordance with provisions set forth by Division V of Chapter 21.21 of the Long Beach Municipal Code.

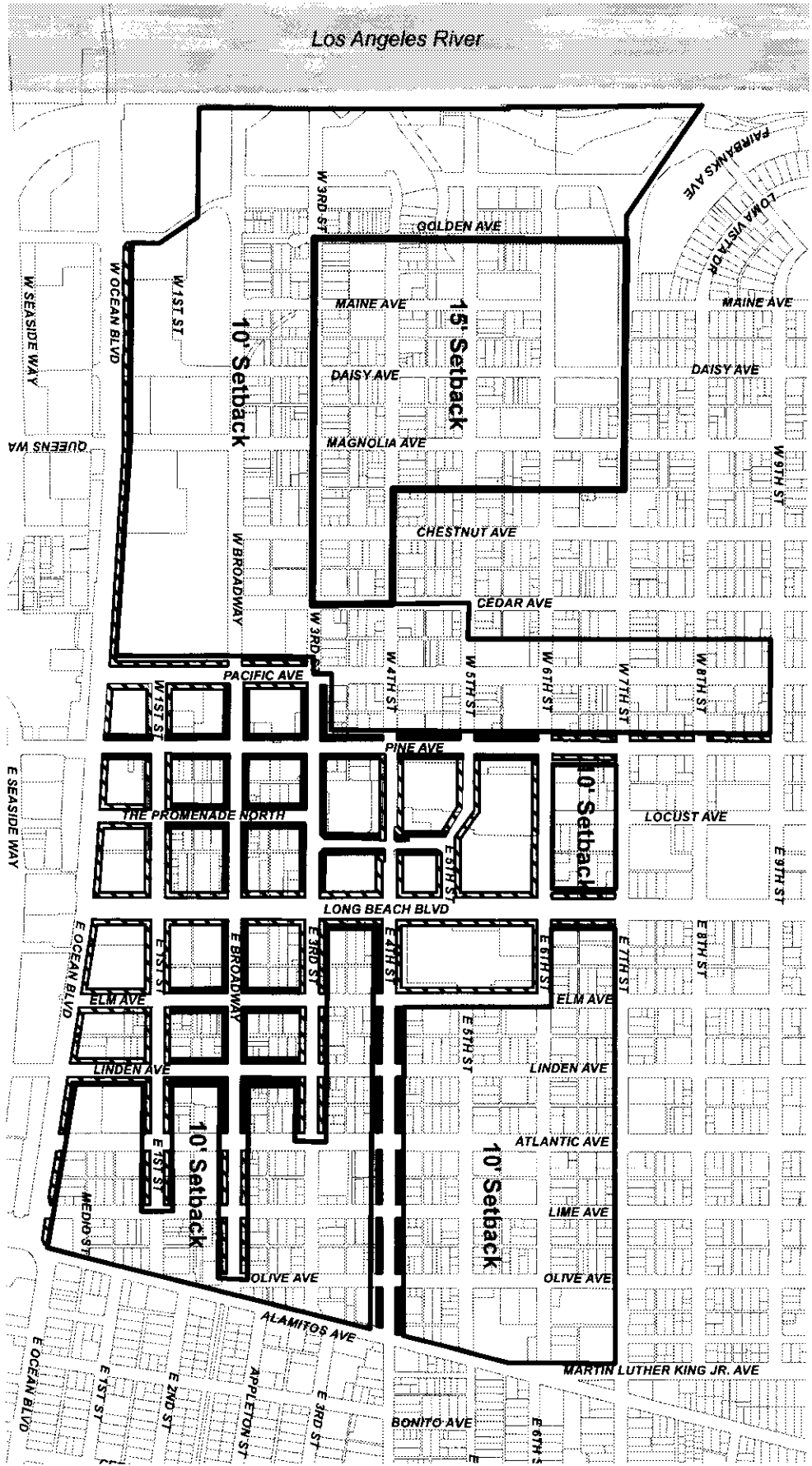

**City of Long Beach**  
**DOWNTOWN PD-30 -- USES DISTRICTS**



City of Long Beach  
 DOWNTOWN PD-30 -- BUILDING SETBACK

- Legend**
-  Required Active Ground Floor Uses
  -  0' Setback
  -  Required Subject to design Standard
  -  10' Setback
  -  15' Setback



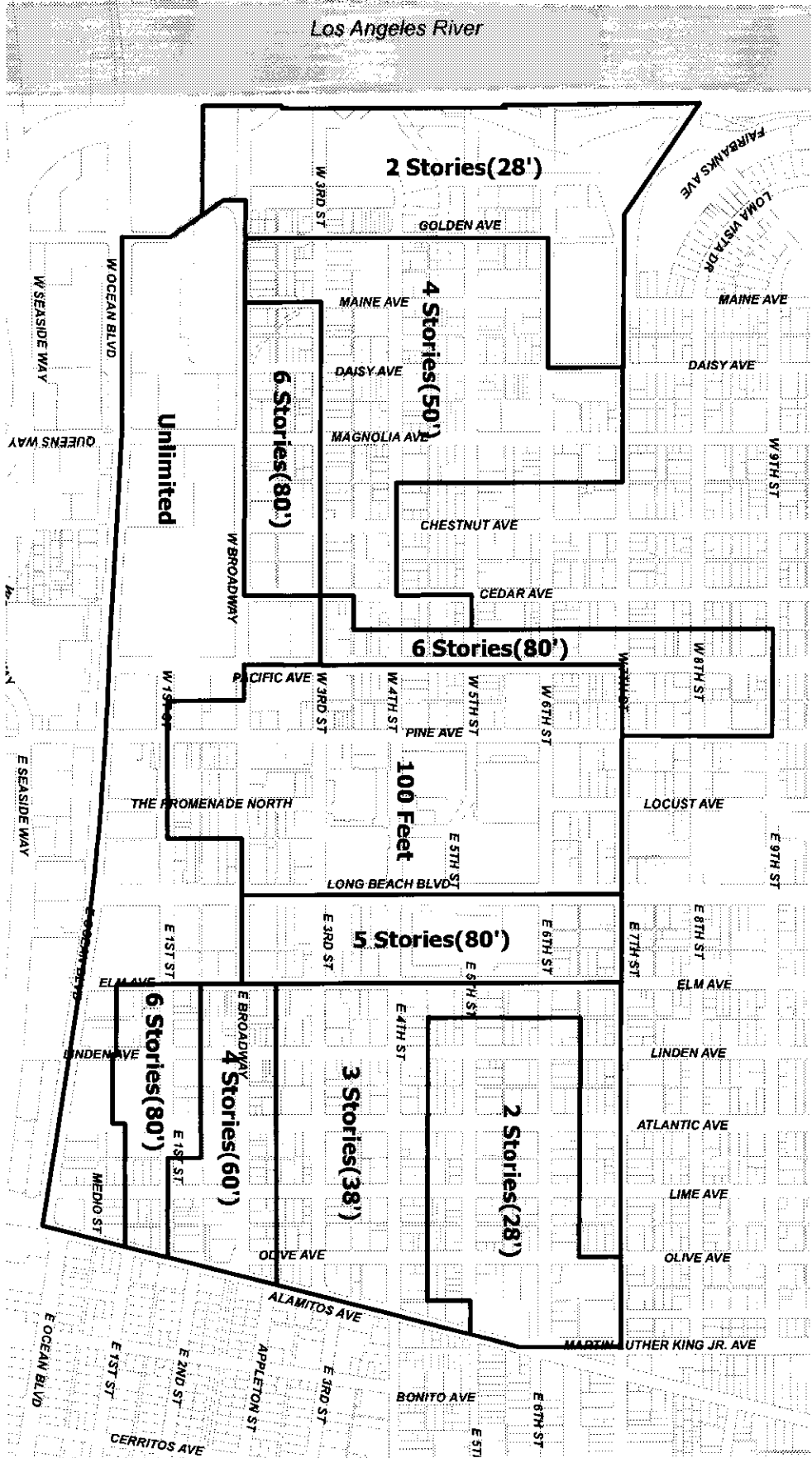

City of Long Beach  
DOWNTOWN PD-30 -- HEIGHT DISTRICTS

Downtown Planned Development District (PD-30)

**APPENDIX A  
Downtown Street Tree Species**

EAST to WEST STREETS

Ninth Street from Pacific Avenue to Pine Avenue  
Magnolia grandiflora/Southern Magnolia

Eighth Street from Pacific Avenue to Pine Avenue  
Cupaniopsis anacardioides/Carrotwood or Tuckeroo

Seventh Street from Golden Avenue to Pacific Avenue  
Pinus canariensis/Canary Island Pine

Seventh Street from Pacific Avenue to Long Beach Boulevard  
Tabebuia cysotricha/Golden Trumpet Tree

Seventh Street from Long Beach Boulevard to Alamos Avenue  
Pinus canariensis/Canary Island Pine

Sixth Street from the Topaz Court to Pacific Avenue  
Trintania conferta/Brisbane Box

Sixth Street from Pacific Avenue to Long Beach Boulevard  
Tabebuia cysotrich/Golden Trumpet Tree

Sixth Street from Long Beach Boulevard to Alamos Avenue  
Trintania conferta/Brisbane Box

Fifth Street from Topaz Court to Pacific Avenue  
Koelreuteria bipinnata/Chinese Flame Tree

Fifth Street from Pacific Avenue to Long Beach Boulevard  
Tabebuia cysotricha/Golden Trumpet Tree

Fifth Street from Long Beach Boulevard to Alamos Avenue  
Koelreuteria bipinnata/Chinese Flame Tree

Fourth Street from Pacific Avenue to Long Beach Boulevard  
Tabebuia cysotricha/Golden Trumpet Tree

Fourth Street from Long Beach Boulevard to Alamos Avenue  
Ulmus parvifolia/Chinese Evergreen Elm

## Downtown Planned Development District (PD-30)

Third Street from Topaz Court to Pacific Avenue  
Cupaniopsis anacardioides/Carrot Wood or Tuckeroo

Third Street from Pacific Avenue to Long Beach Boulevard  
Pyrus kawakamii/Evergreen Pear

Third Street from Long Beach Boulevard to Alamitos  
Cupaniopsis anacardioides/Carrot Wood or Tuckeroo

Broadway from Topaz Court to Pacific Avenue  
Bauhinia blakeana/Hong Kong Orchid

Broadway from Pacific Avenue to Long Beach Boulevard  
Tabebuia caryocarpa/Golden Trumpet Tree

Broadway from Long Beach Boulevard to Alamitos Avenue  
Bauhinia blakeana/Hong Kong Orchid

First Street from Pacific Avenue to Long Beach Boulevard  
Tabebuia caryocarpa/Golden Trumpet Tree

First Street from Long Beach Boulevard to Alamitos Avenue  
Cassia leptophylla/Golden Medallion Tree

Ocean Boulevard from Golden Avenue to Alamitos Avenue  
Washingtonia filifera/California Fan Palm

### NORTH to SOUTH STREETS

Topaz Court from Broadway to Seventh Street  
Pinus Canariensis/Canary Island Palm

Golden Avenue from Ocean to Seventh Street  
Ginkgo biloba/Maidenhair Tree - male only

Main Avenue from Broadway to Seventh Street  
Cupaniopsis anacardioides/Carrotwood or Tuckeroo

Daisy Avenue from Broadway to Seventh Street  
Jacaranda mimosifolia/Jacaranda

Magnolia Avenue from Ocean to Seventh Street  
Magnolia grandiflora/Southern Magnolia

Downtown Planned Development District (PD-30)

Chestnut Avenue from Broadway to Seventh Street  
Calondendrum capense/Cape Chestnut

Cedar Avenue from Broadway to Seventh Street  
Podocarpus gracillior/Fern Pine

Pacific Avenue from Ocean Boulevard to Seventh Street  
Tabebuia cysotricha/Golden Trumpet Tree and Washington filifera/California Fan Palm

Pacific Avenue from Seventh Street to Ninth Street  
Washingtonia filifera/California Fan Palm

Pine Avenue from Ocean Boulevard to Seventh Street  
Tabebuia cysotricha/Golden Trumpet Tree and Washingtonia filifera/California Fan Palm

Pine Avenue from Seventh Street to Ninth Street  
Cupaniopsis anacardioides/Carrotwood or Tuckeroo

Promenade North from Ocean Boulevard to Third Street  
Robinia pseudoacacia/Black Locust

Locust Avenue from Sixth Street to Seventh Street  
Tabebuia cysotricha/Golden Trumpet Tree and Washingtonia filifera/California Fan Palm

Long Beach Boulevard from Ocean Boulevard to Seventh Street  
Tabebuia cysotricha/Golden Trumpet Tree and Washingtonia filifera/California Fan Palm

Elm Avenue from Ocean to Seventh Street  
Ulmus parvifolia/Chinese Evergreen Elm

Linden Avenue from Ocean Boulevard to Seventh Street  
Arcastrum romansoffianum/Queen or Coco Palm

Atlantic Avenue from Ocean to Seventh Street  
Archontophoenix cunninghamiana/King Palm

Lime Avenue from Ocean Boulevard to Seventh Street  
Magnolia grandiflora/Southern Magnolia

Downtown Planned Development District (PD-30)

Olive Avenue from Broadway to Seventh Street  
Jacaranda mimosifolia/Jacaranda

Alamitos Avenue from Ocean to Seventh Street  
Fraxinus oxycarpa/Ash