

*Bixby Knolls*  
LONG BEACH

Bixby Knolls Atlantic Avenue Business Corridor.  
**One Vision.**

**Goal:**

To plant the seeds of programs which will help revitalize the Bixby Knolls business corridor on Atlantic Avenue between San Antonio Drive and Bixby Road.

We are presenting our suggestions in a series of small vignettes. Enhancements with a synergistic effect are grouped together; all the enhancements combine to build a presentation of our vision for Bixby Knolls. Each scene provides a small step forward in the revitalization process and each can be independently executed from the others.

Ultimately though, it is the excitement and involvement of those who work at and own business along the corridor that will make this endeavor a success. Therefore, if this document can serve as a starting point for discussions which lead to actions, it will have provided the first big step toward revitalization.



*Bixby Knolls*  
LONG BEACH

Bixby Knolls  
A new beginning!

**G** GRENEKER  
SOLUTIONS



There was a time,  
not so long ago,  
when families walked,  
and children played here.

When shops and services and  
restaurants formed the social  
foundation of the location.

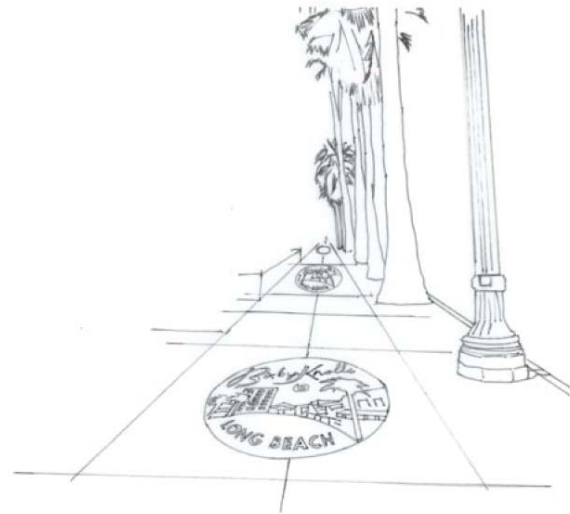

Step by step we seek to revitalize the Bixby Knolls business corridor, so that those finer times can fall upon us again!

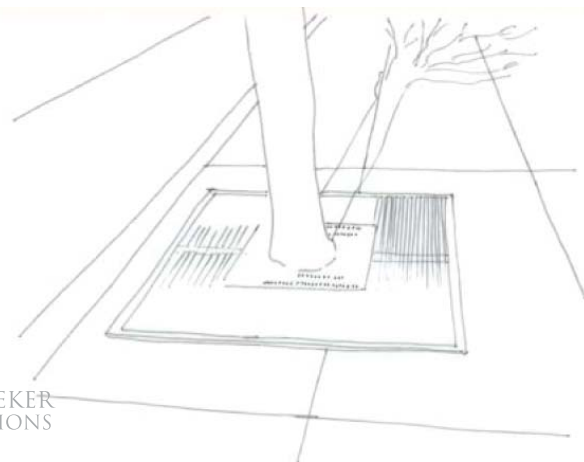
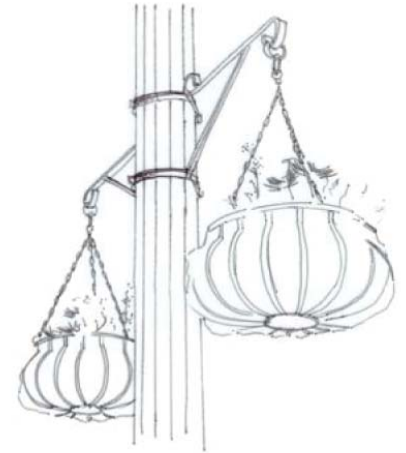

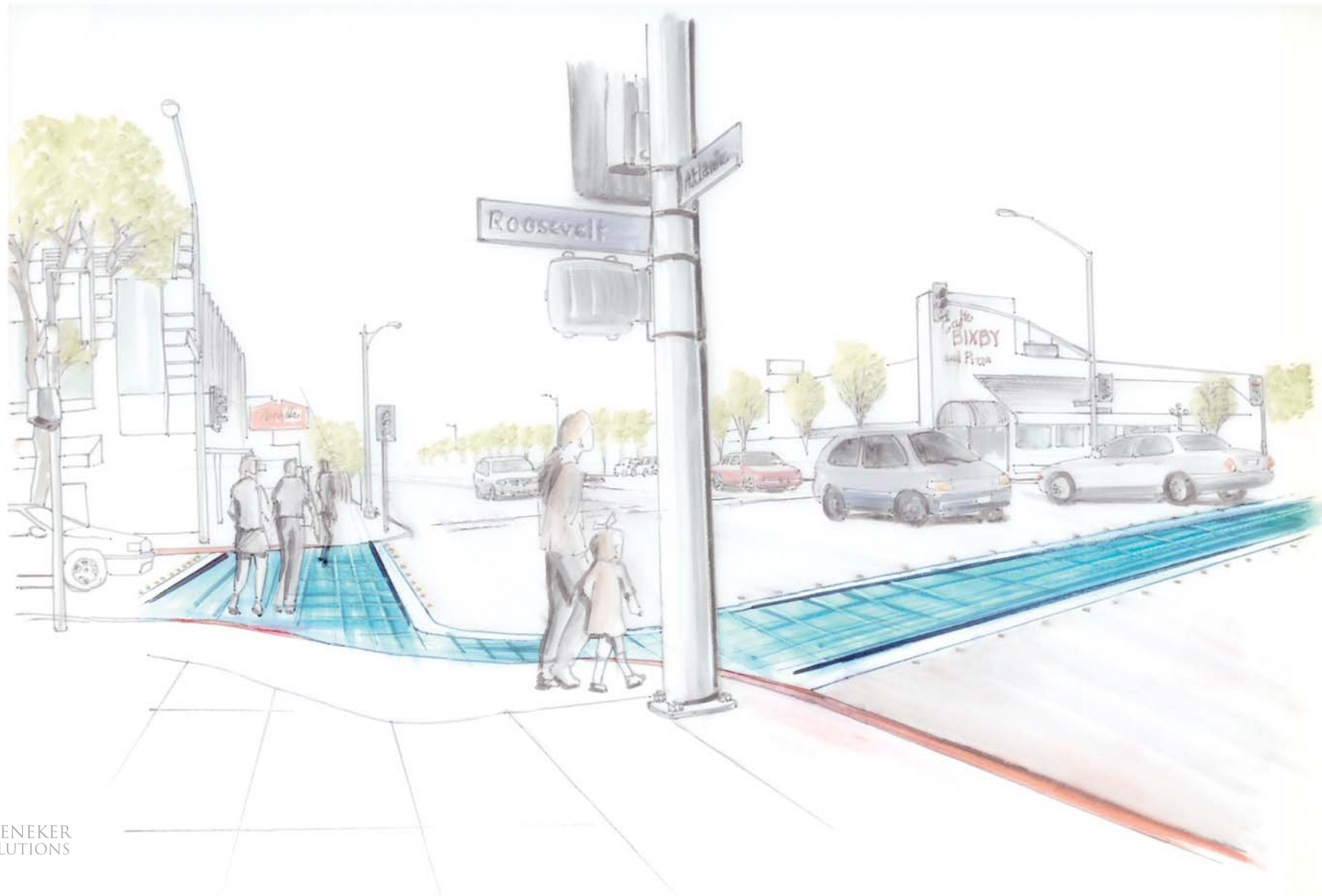

One of the primary goals is to make Bixby Knolls pedestrian friendly.

Paramount to the success of making Bixby Knolls a destination is the need to slow down the traffic flowing through the area.

The ways to accomplish this are:

1. Increase the curiosity factor. Providing visual stimulation which is interesting automatically slows traffic as it raises the curiosity factor. Painted/lighted crosswalks, color coordinated facades, tree lighting and more are all methods of getting drivers to slow down and look.
2. Increasing the driver's awareness that this is legally a pedestrian zone; larger speed limit signs, resync'd traffic lights and other engineered solutions are available for this.



## pedestrian priorities

To be pedestrian friendly, the Bixby Knolls corridor needs to provide some basic pedestrian amenities.

1. Resting spaces
2. Illumination
3. Waste containers.

These allow the pedestrian to feel “safe” and “comfortable” with the area, knowing places to stop, rest, and unload unwanted items from being carried are available.



signage systems

To further enhance the pedestrian experience, the Bixby Knolls corridor needs to “tell” the user what’s in the area in a single glance.





Pointing out any particular point of interest is the job of our blade signs and street menus.

looking up looking down

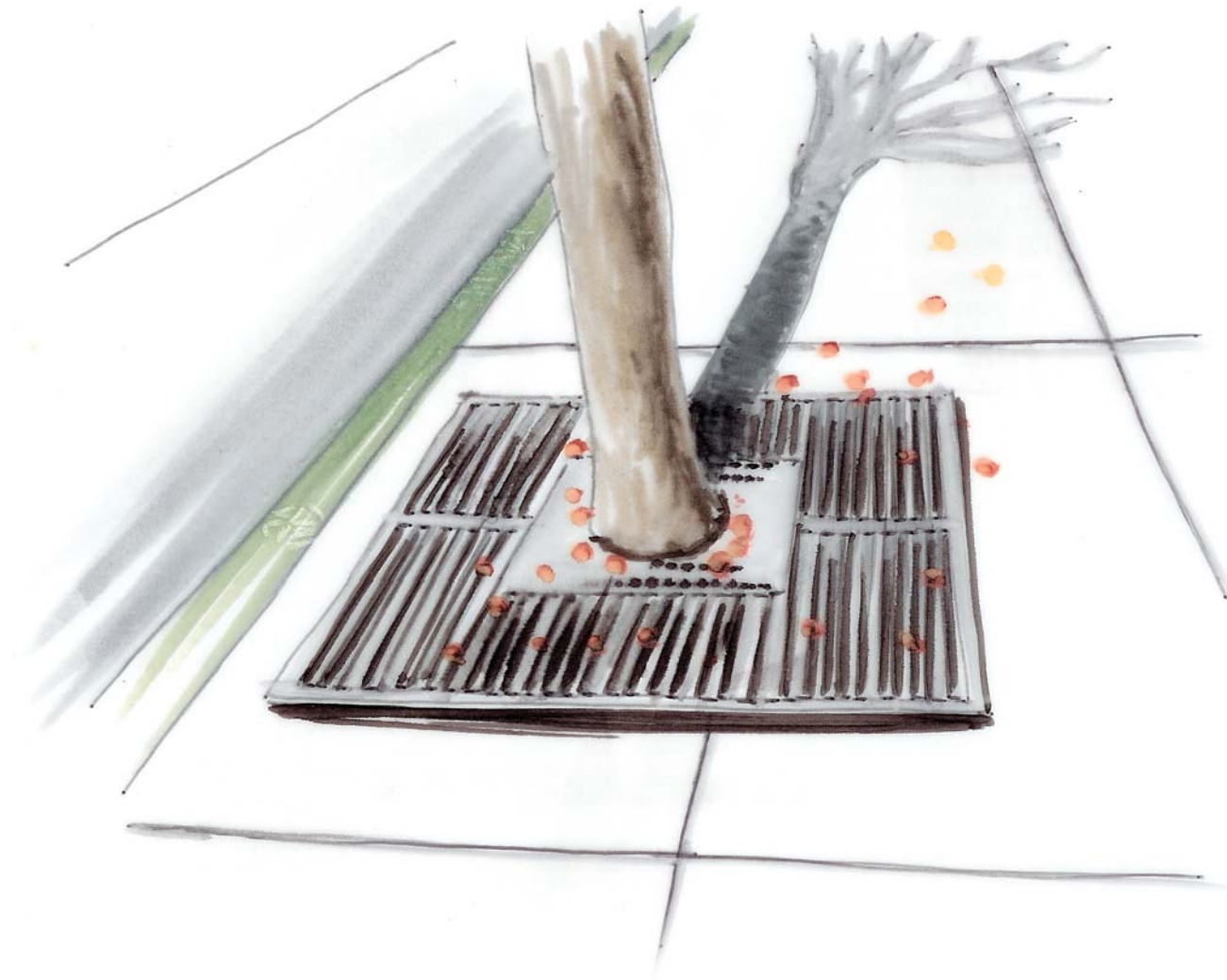

Looking up,  
Looking down,  
Looking all around.

Everywhere the pedestrians  
and the drivers look -

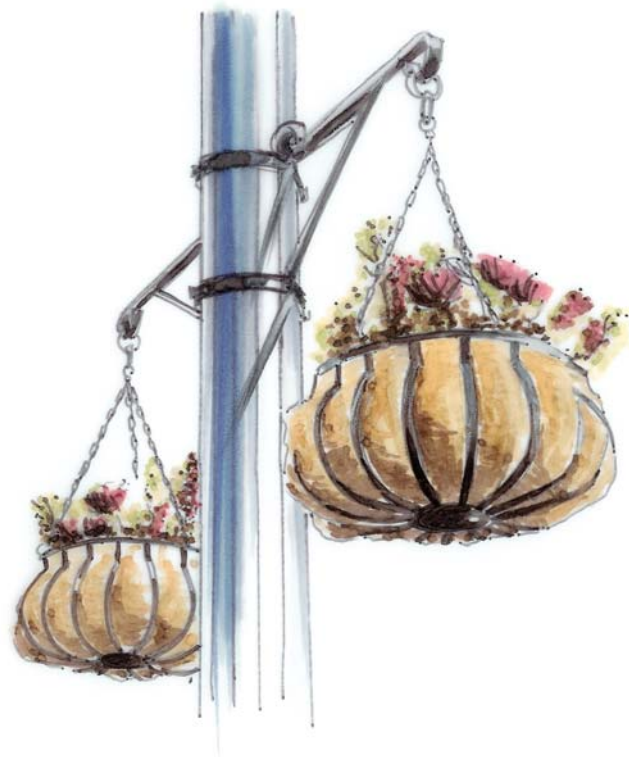

The elements defining Bixby Knolls should be apparent -

*Bixby Knolls*  
LONG BEACH

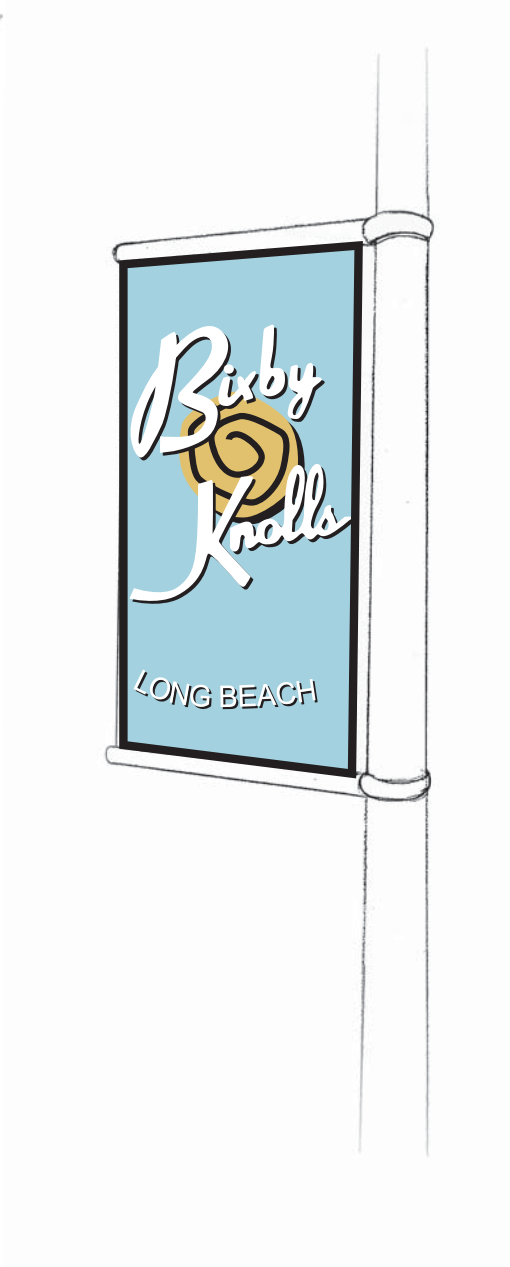

Tying together the area, giving it a sense of destination and community.

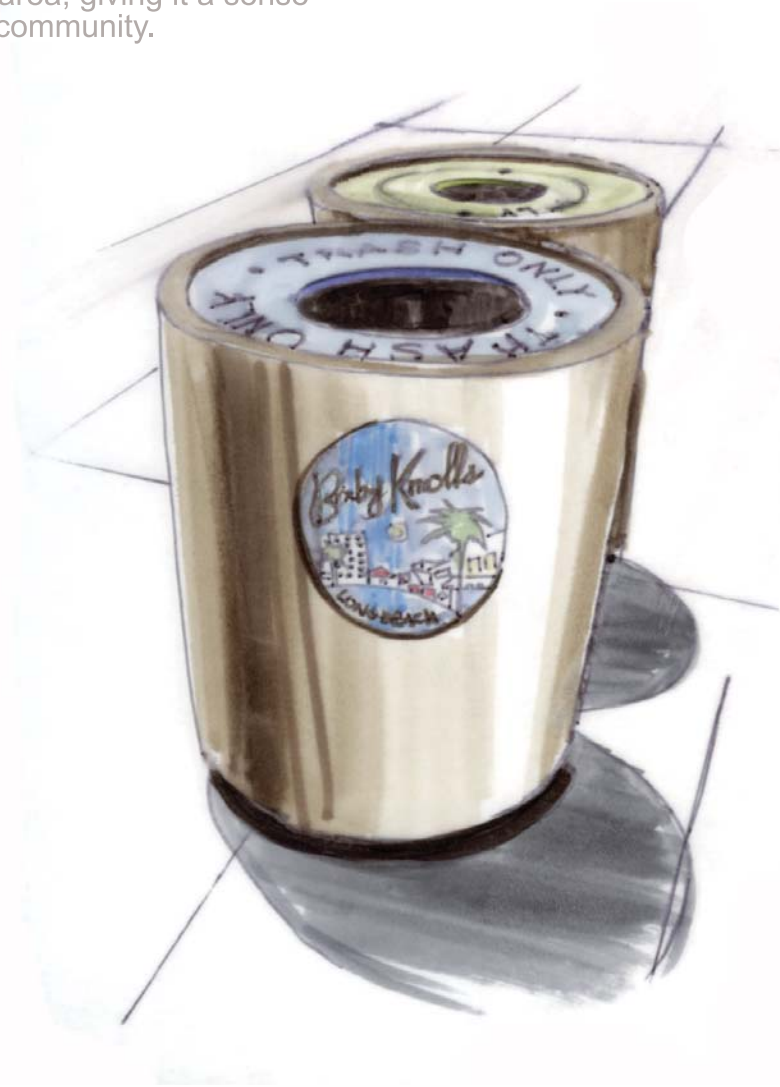

A color palette will unify the area and help create a zone effect.



before



after





## Designs and Inspirations

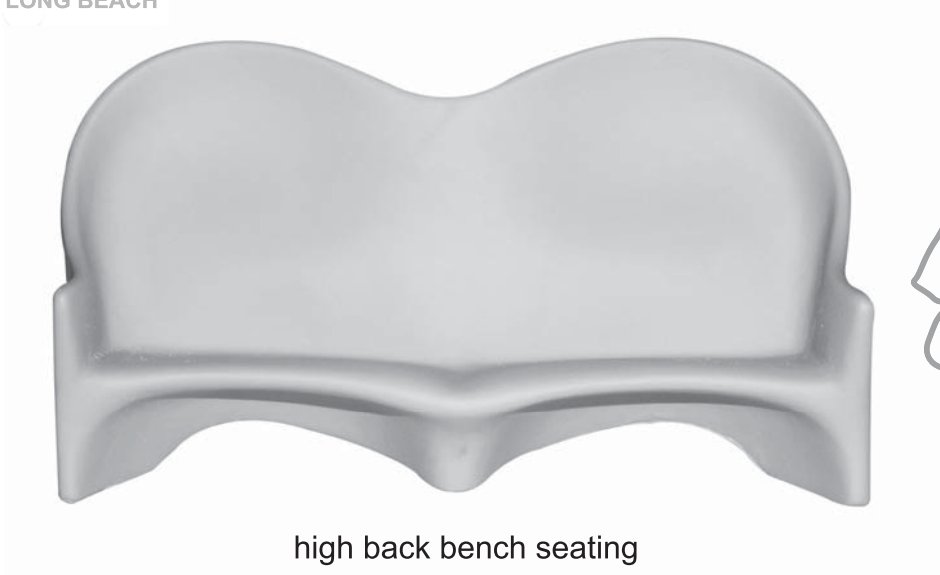

high back bench seating



decorative urns

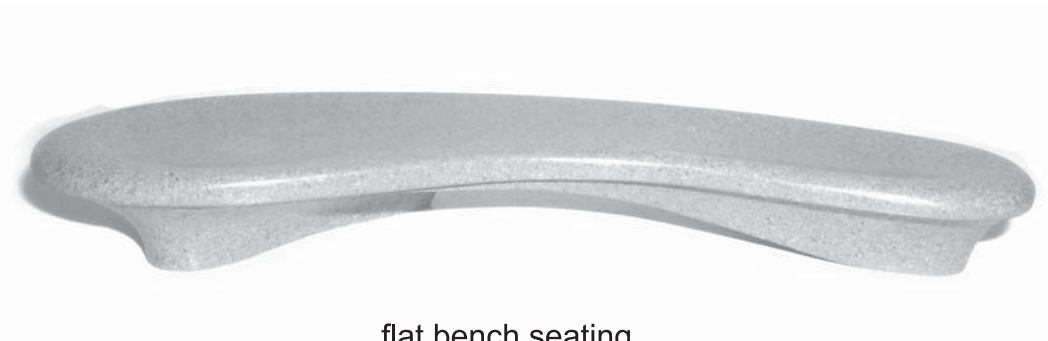
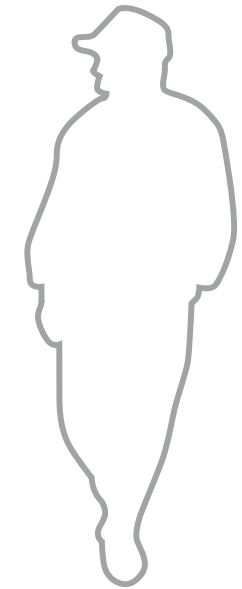

flat bench seating



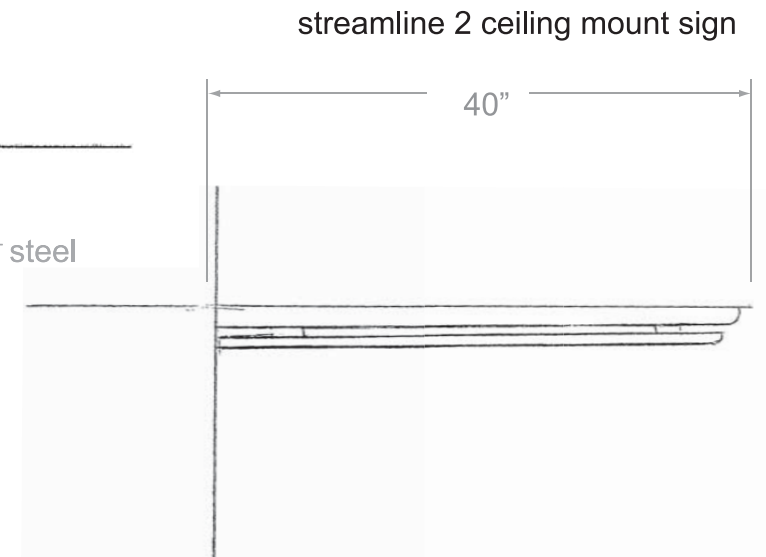
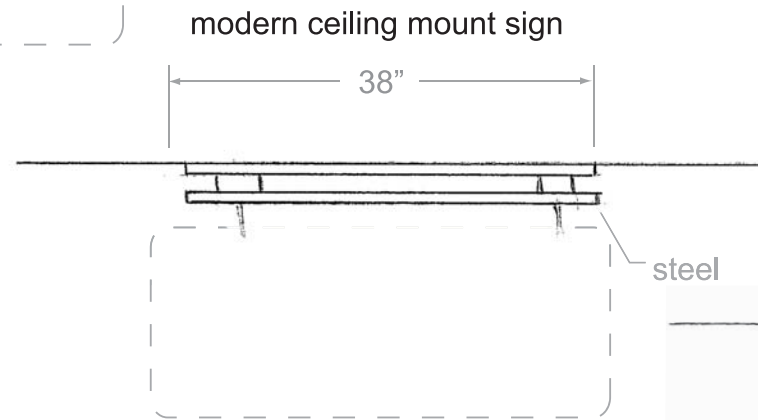
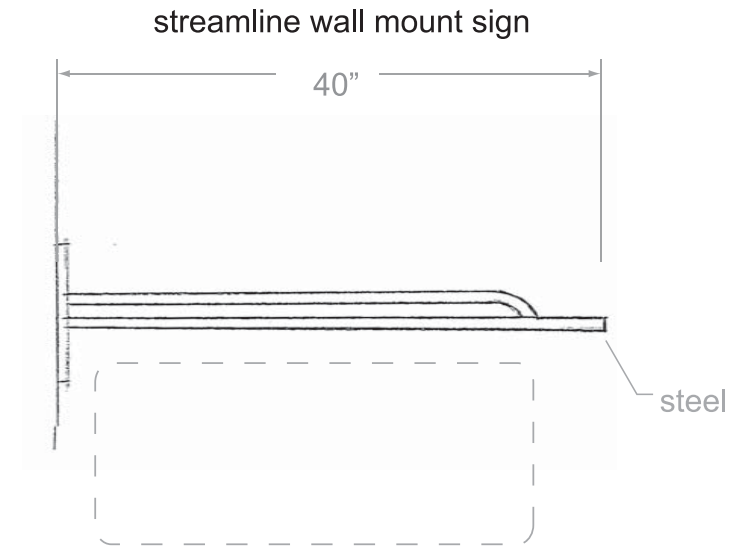
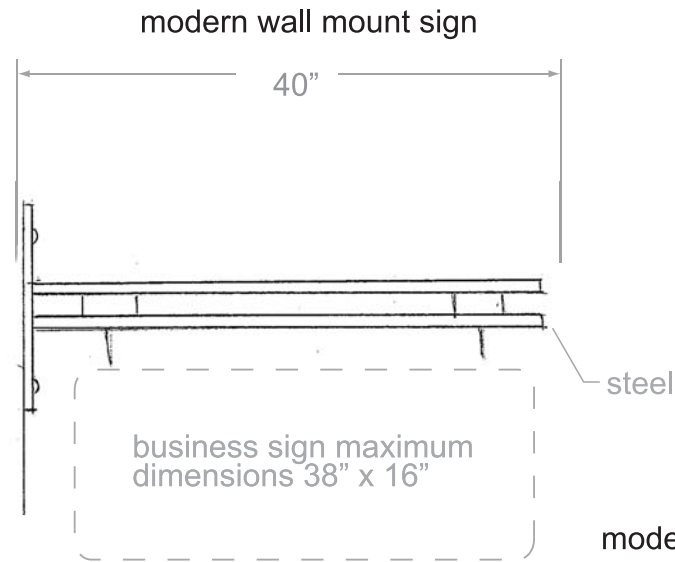

40" twisted arm sign holder

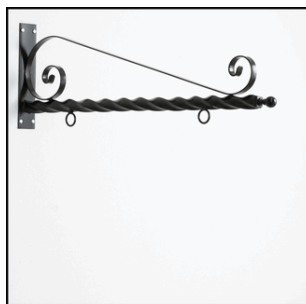

streamline bracket

16" round fiberglass pot

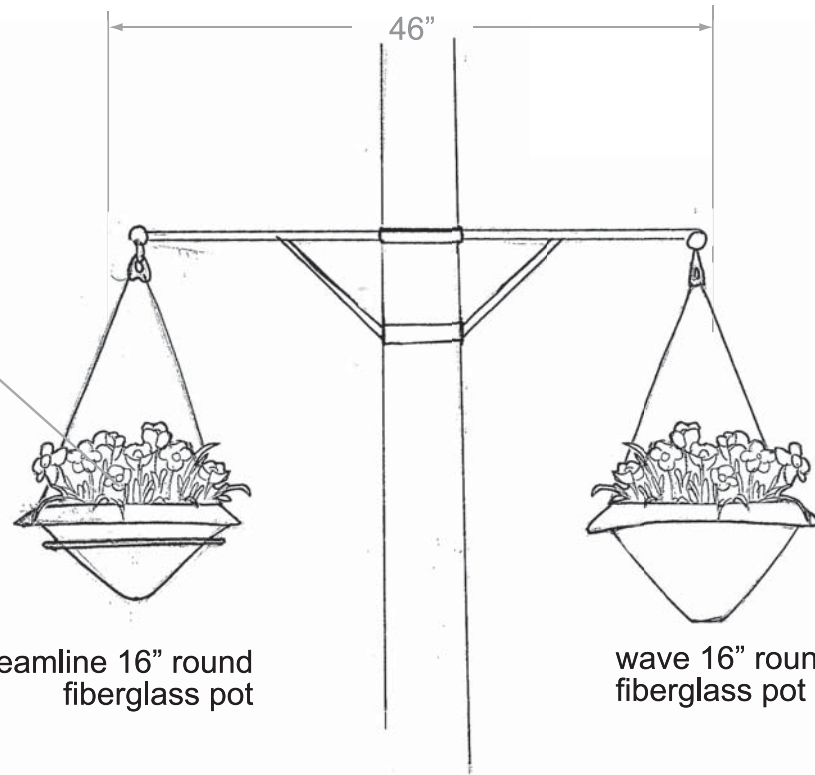

front view

flowers and pottery

classic bracket

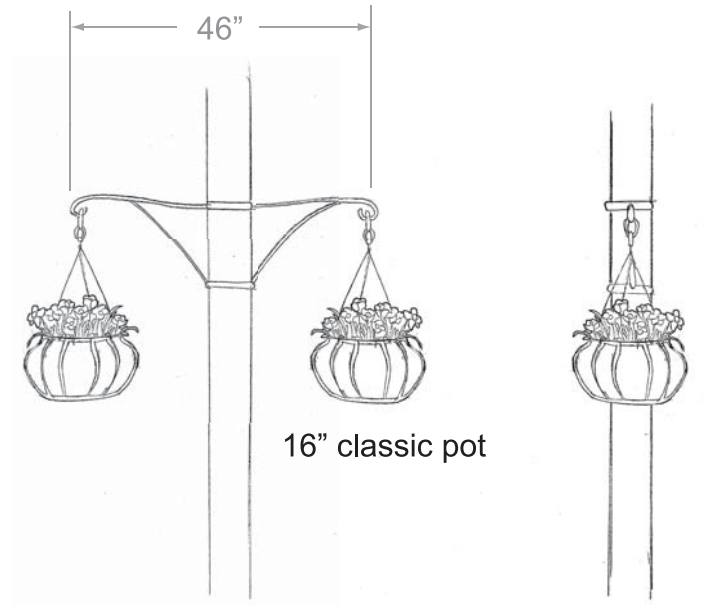

front view

side view



standard 22" pot

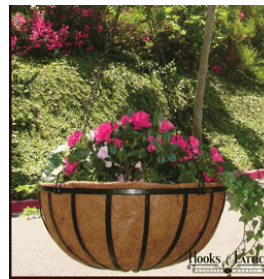

standard 14" pot



standard 40" wide bracket system

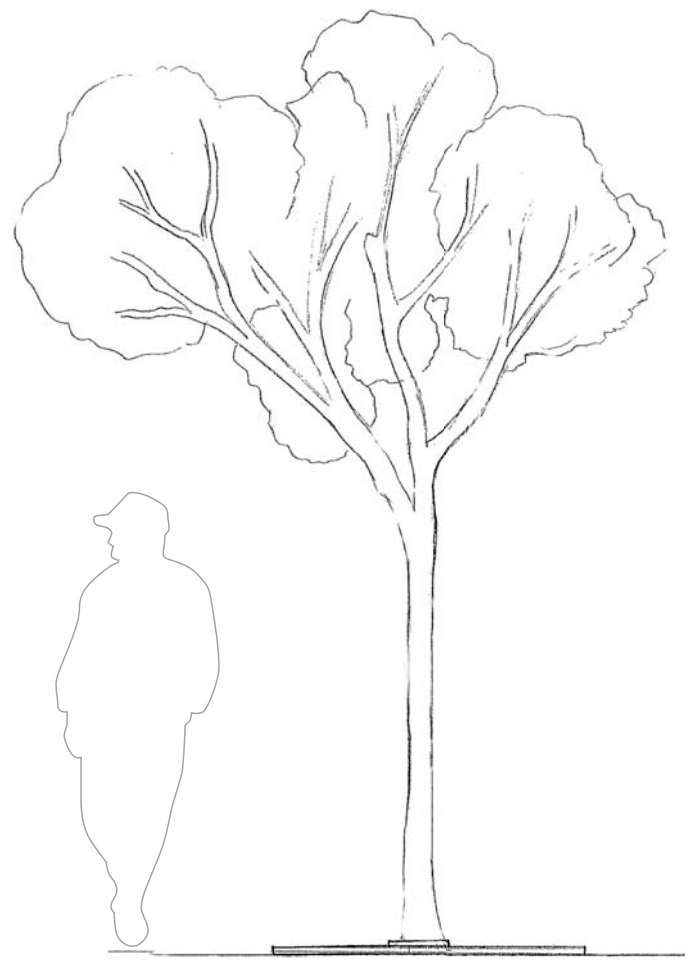

sidewalk tree grate

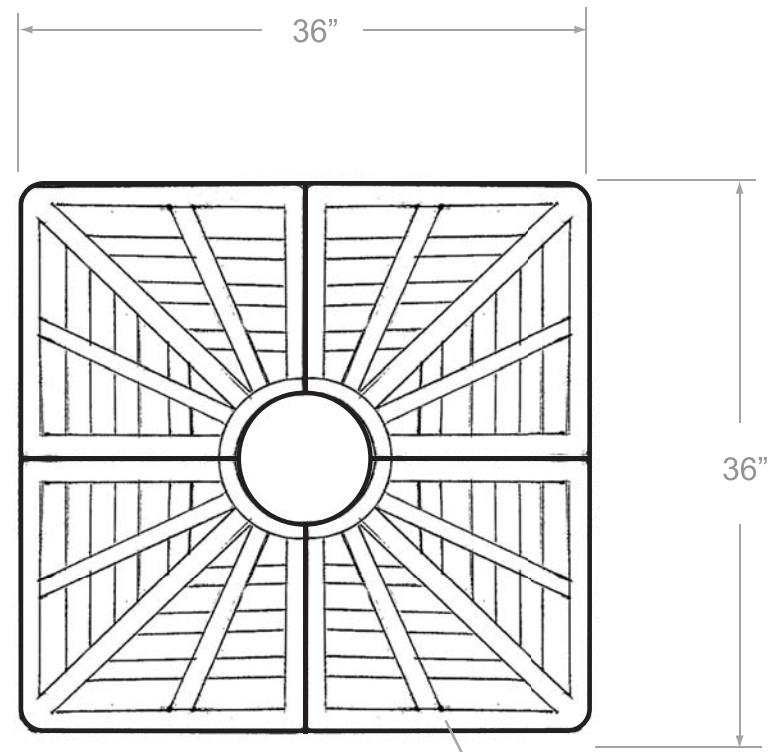

top view

welded steel or fiberglass

3' roadway tree grate

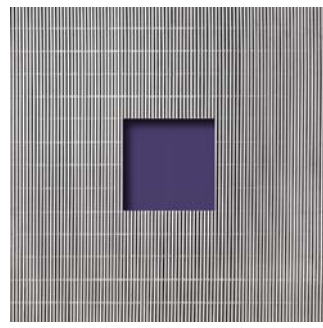

3' ring tree grate

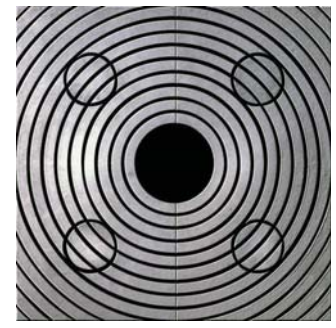

*Bixby Knolls*  
LONG BEACH

monument sign a



monument

monument sign b

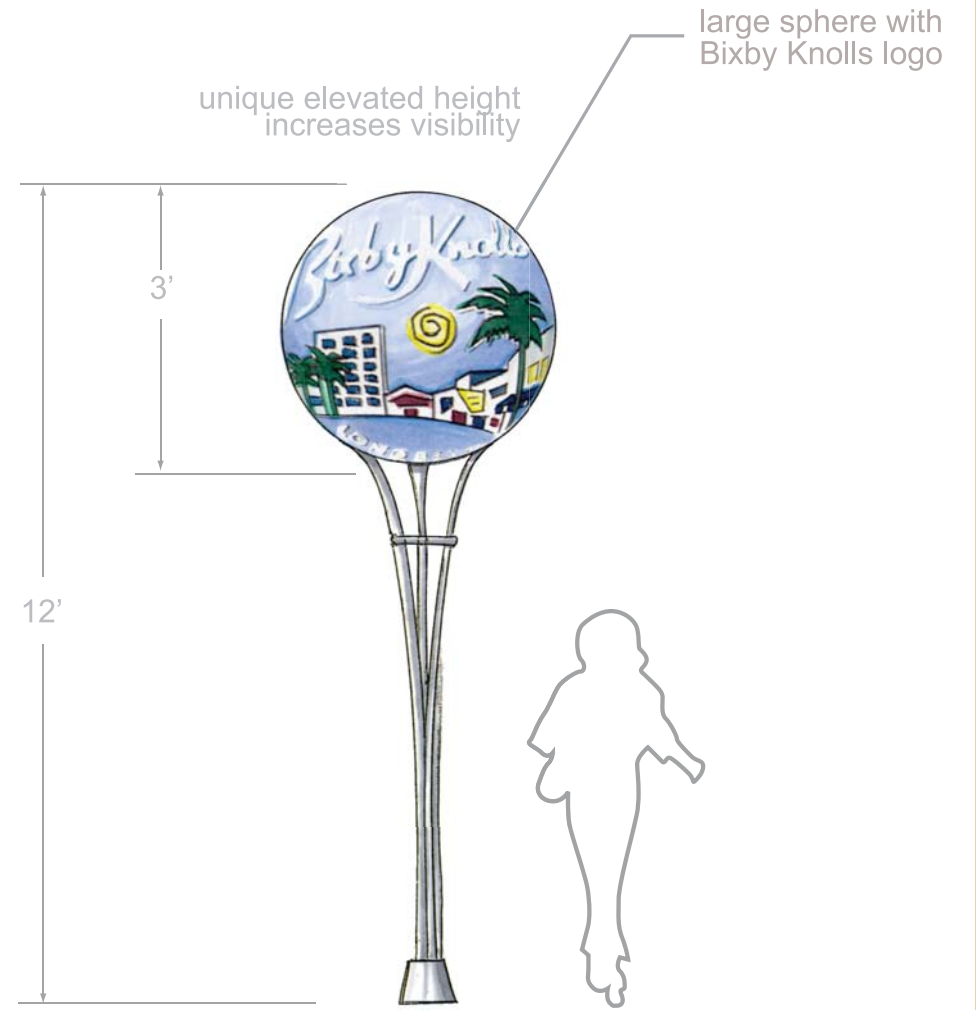

front view

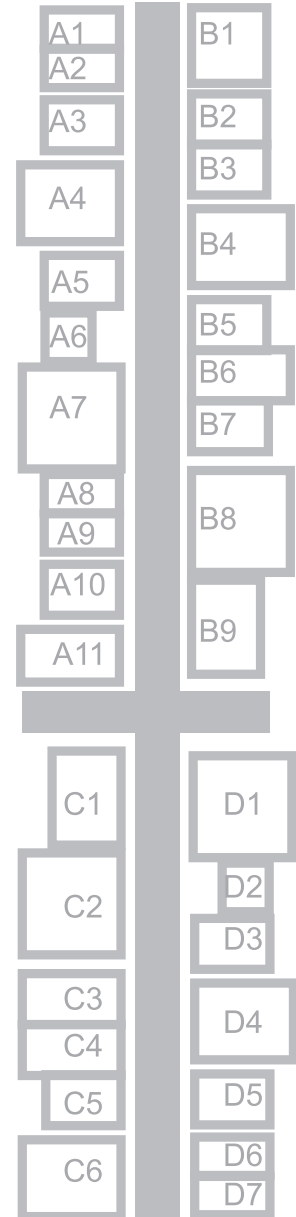
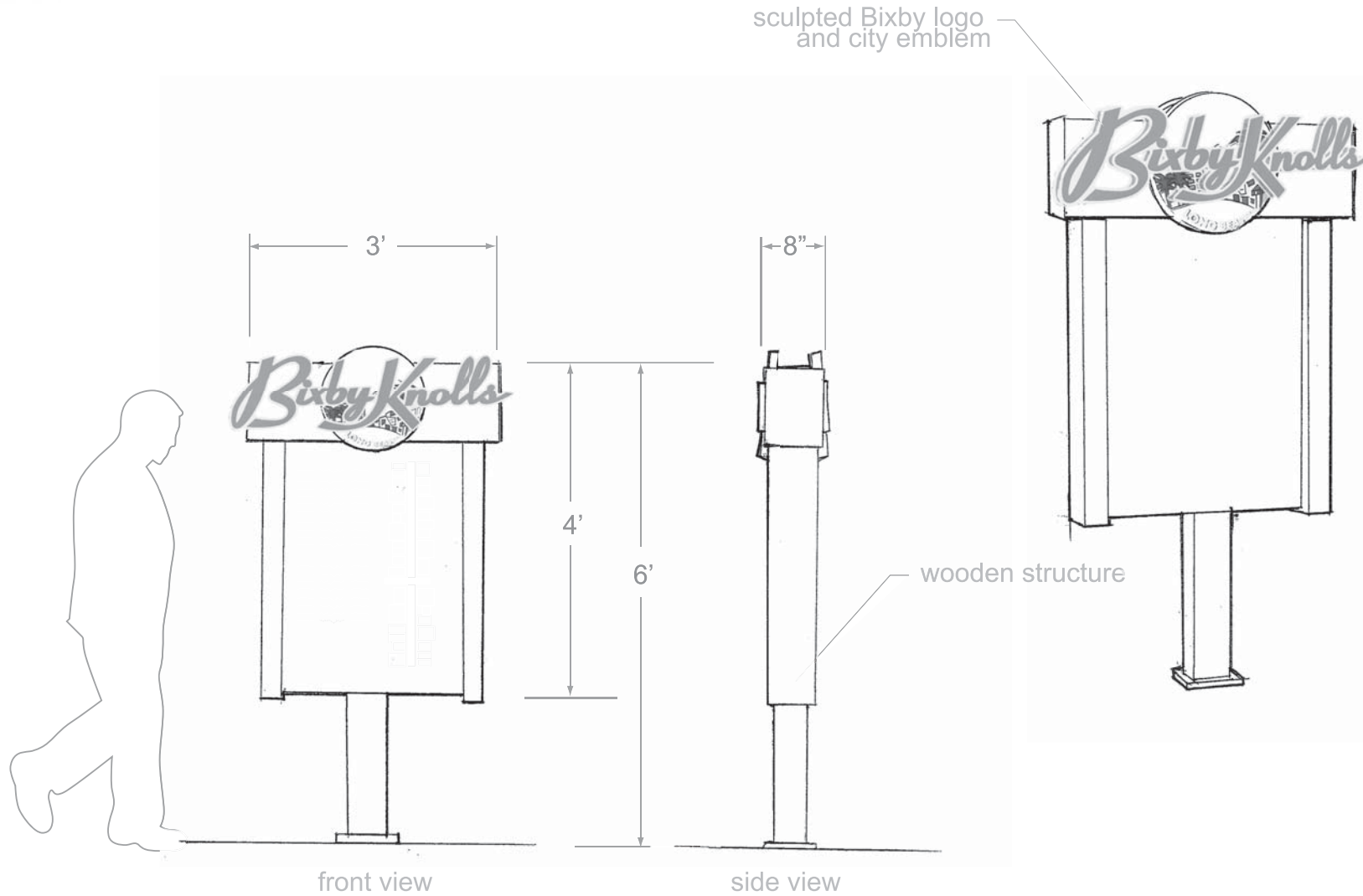
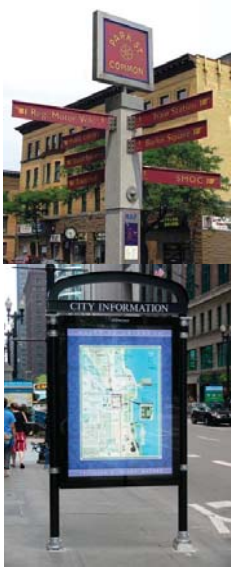

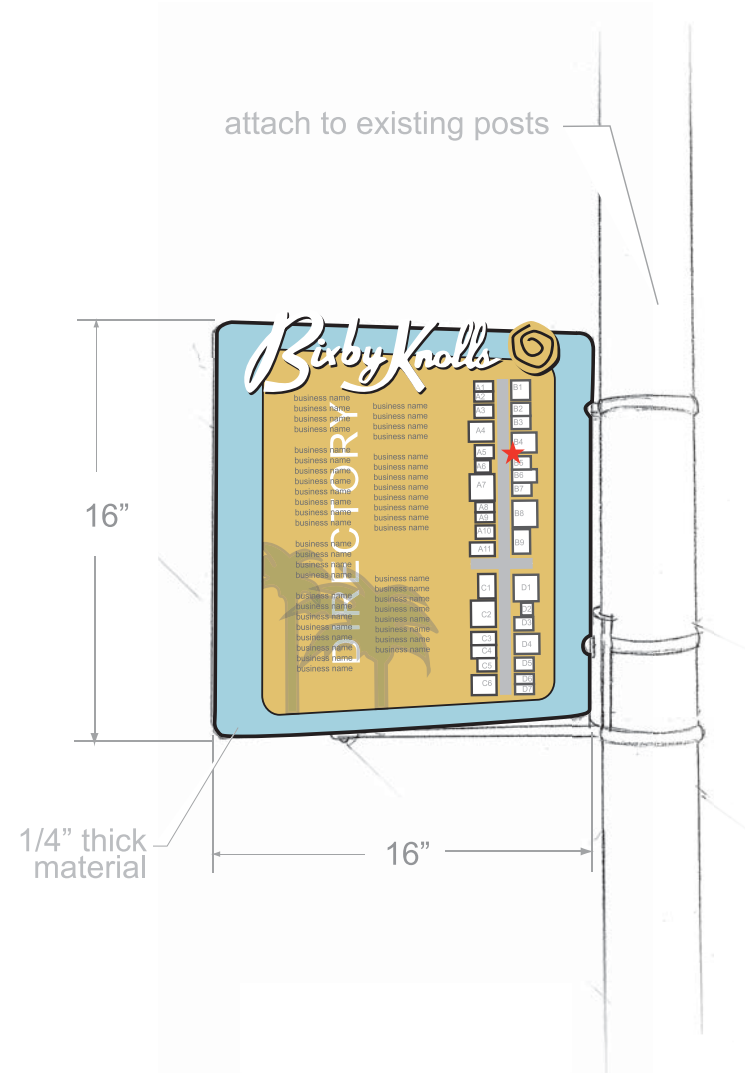
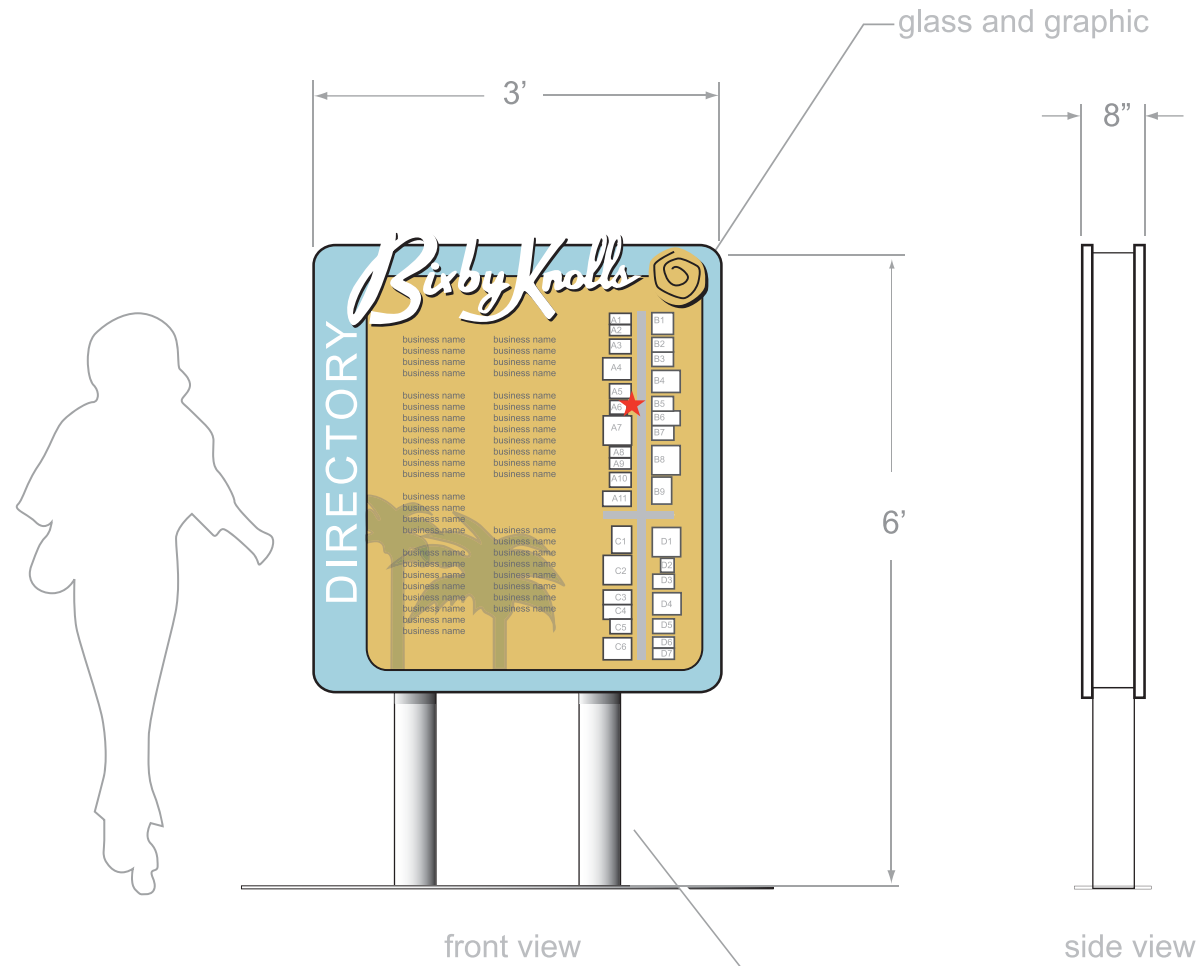

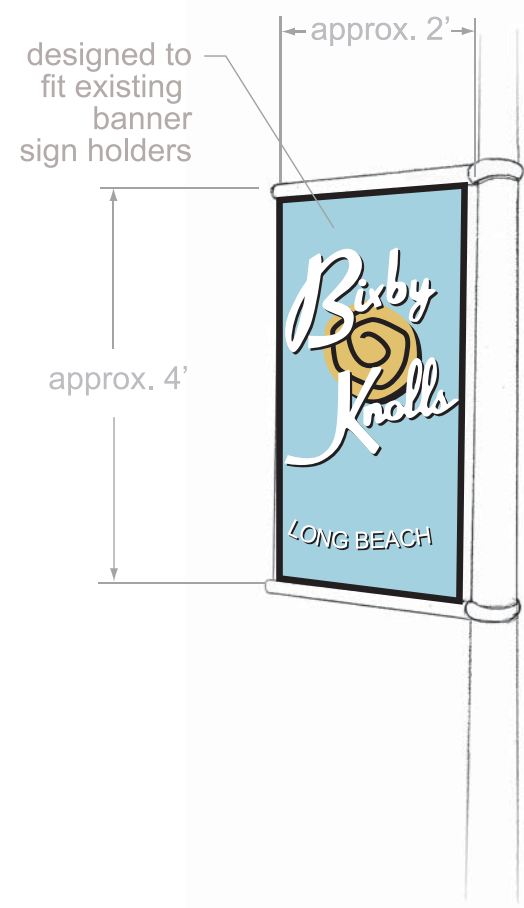

a

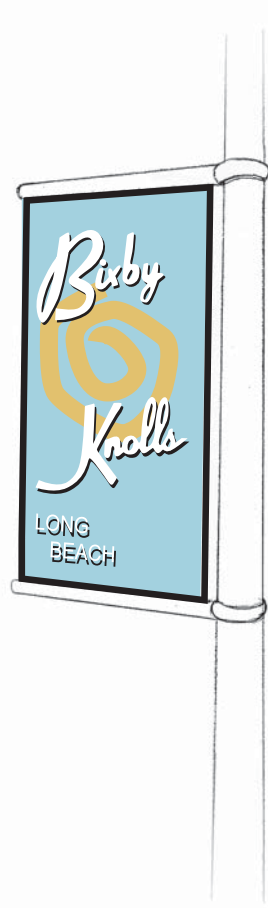

b



c



d

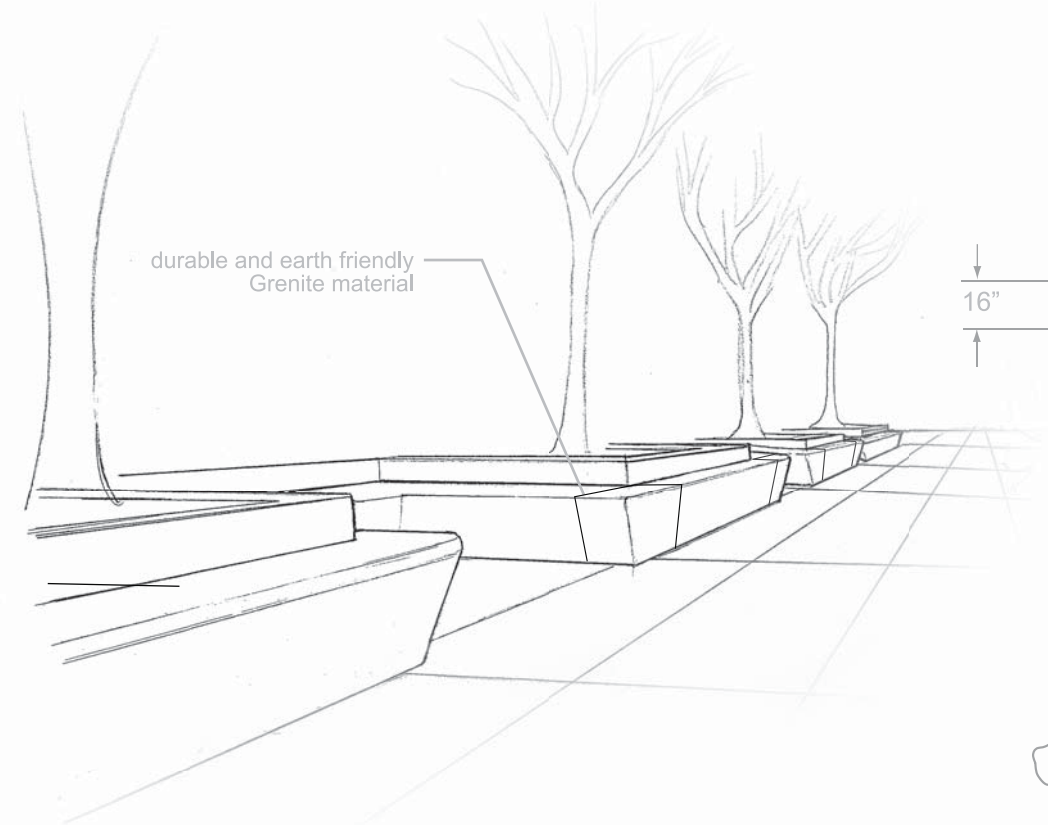

durable and earth friendly  
Grenite material

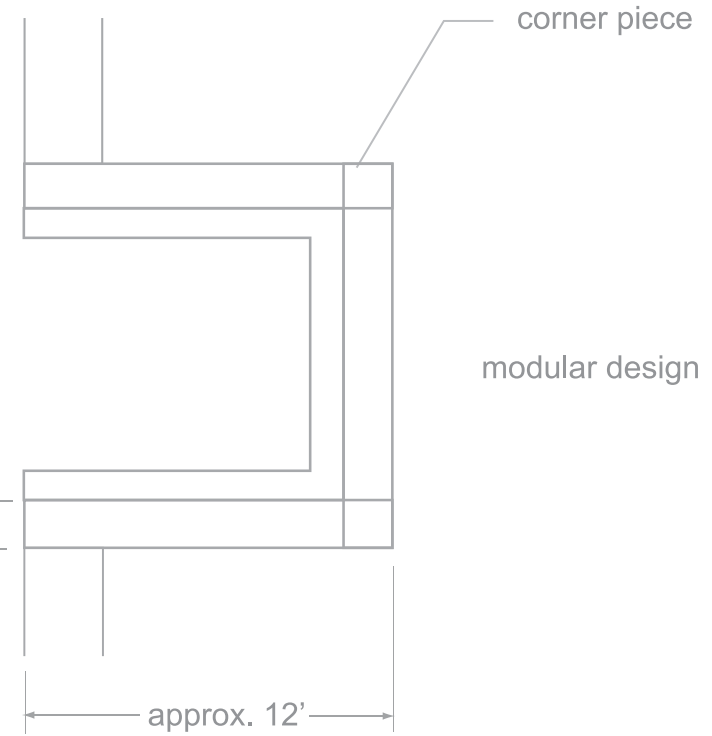

corner piece

modular design

16"

approx. 12'

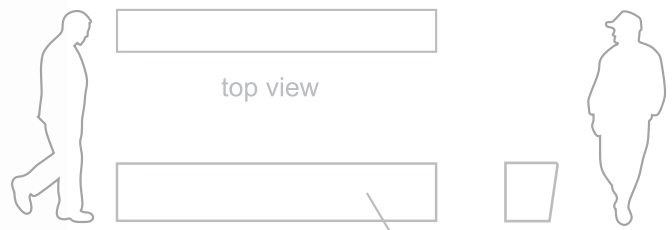

top view

front view

side view

18" seat height



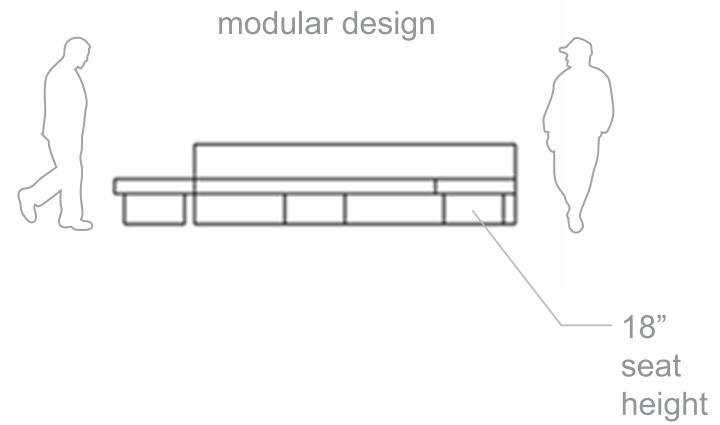
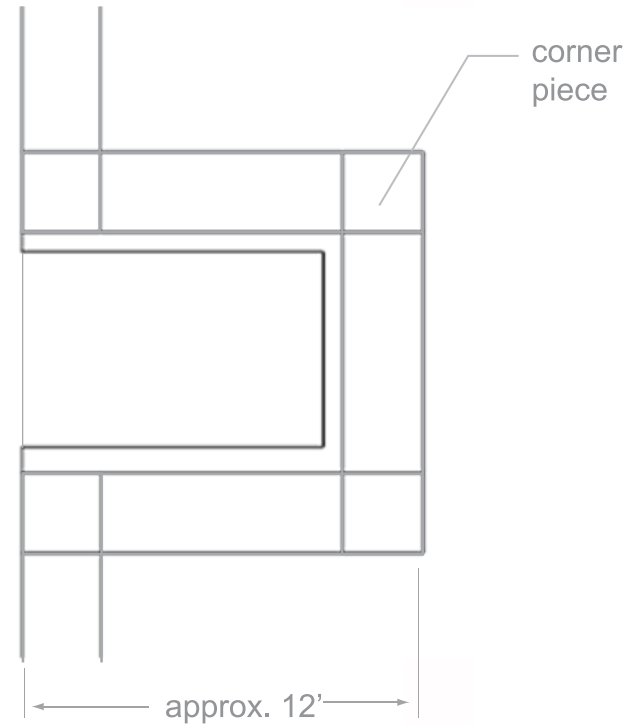
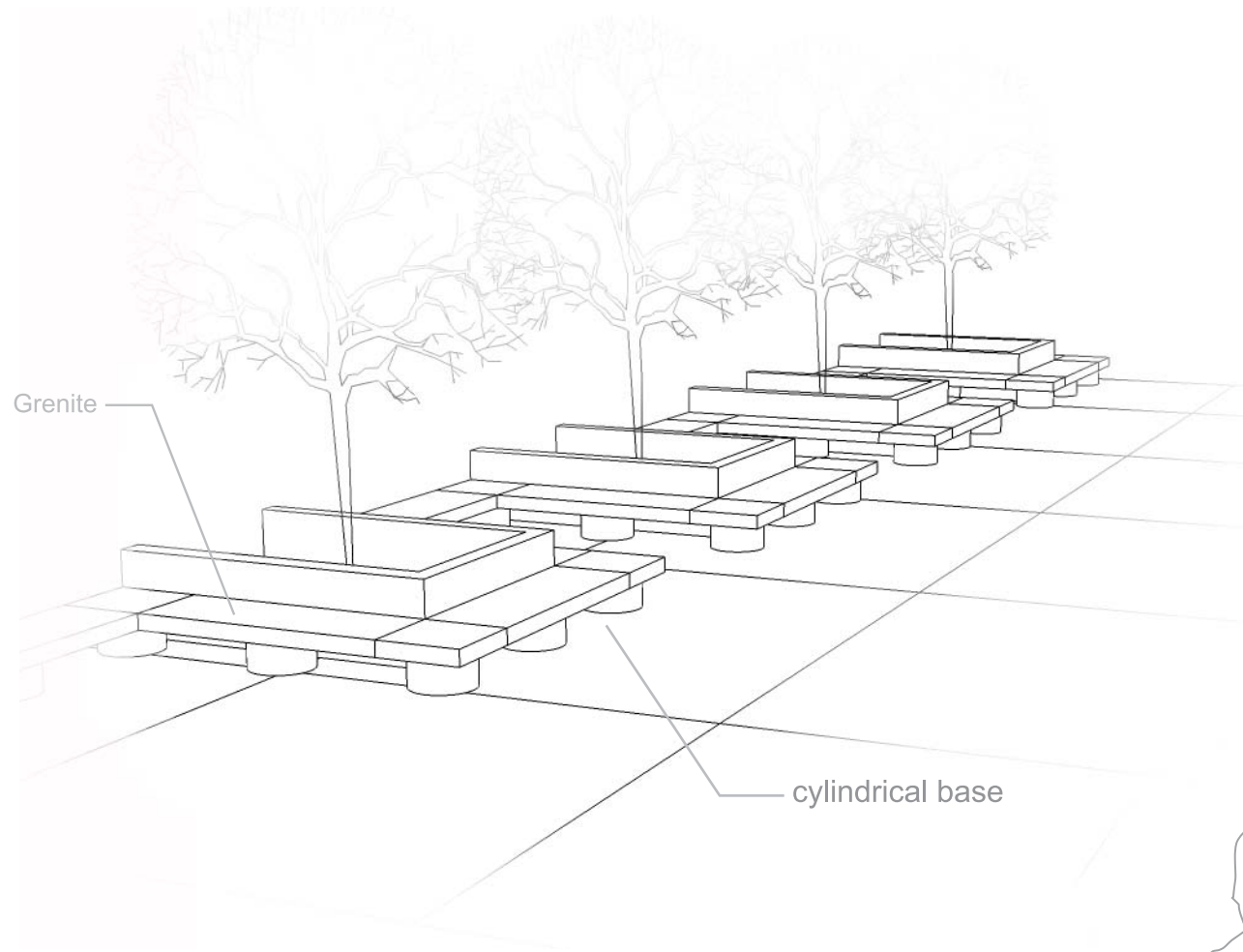

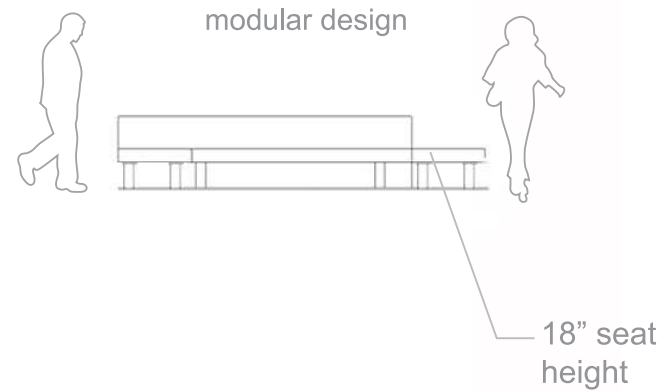
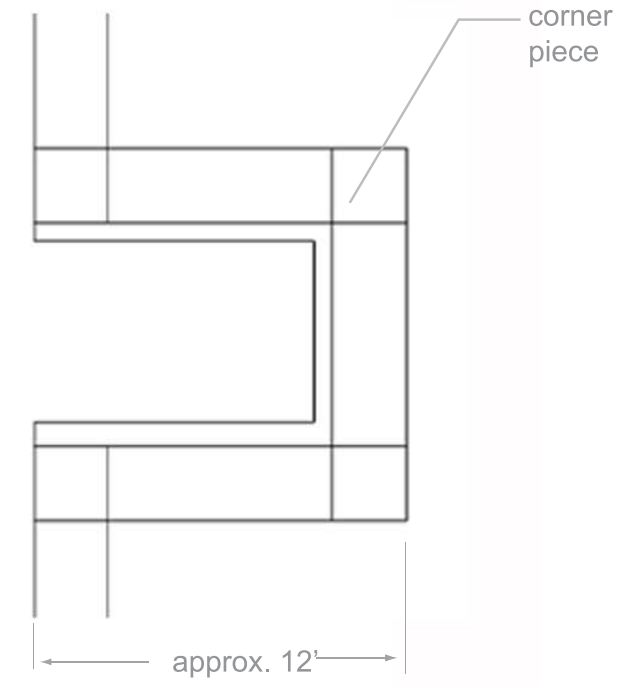
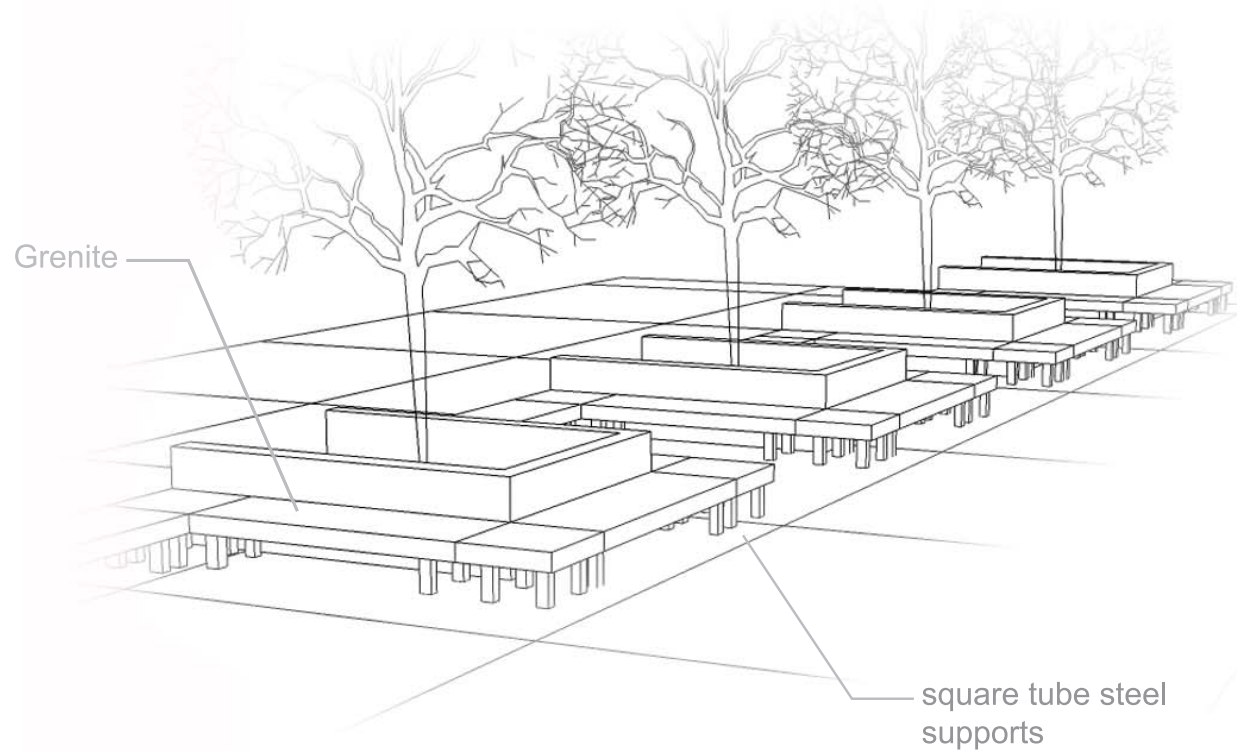

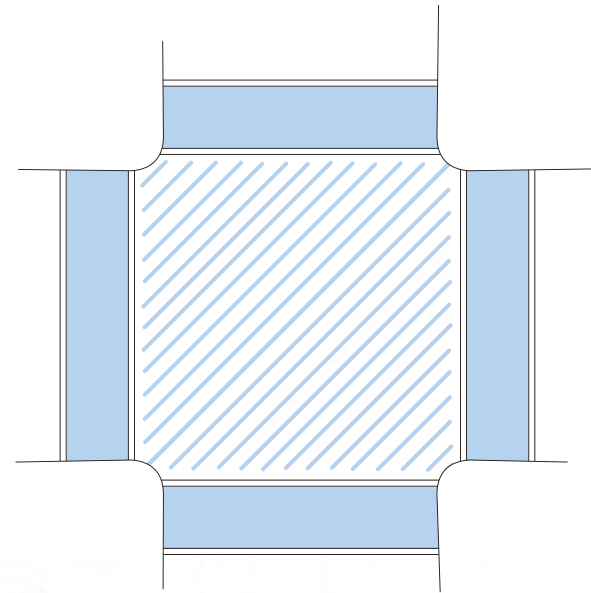

four-way intersection

crosswalk

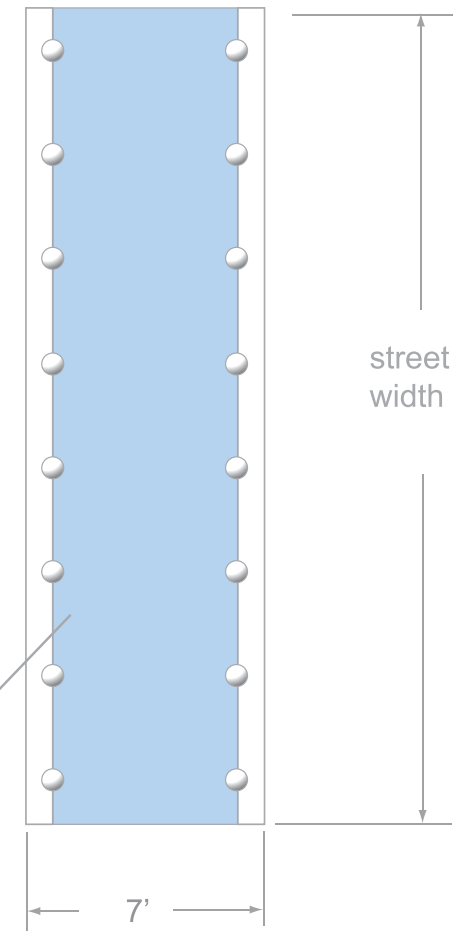

blue tiled or stained crosswalk with reflective bumps



Bixby emblem  
embedded  
into concrete

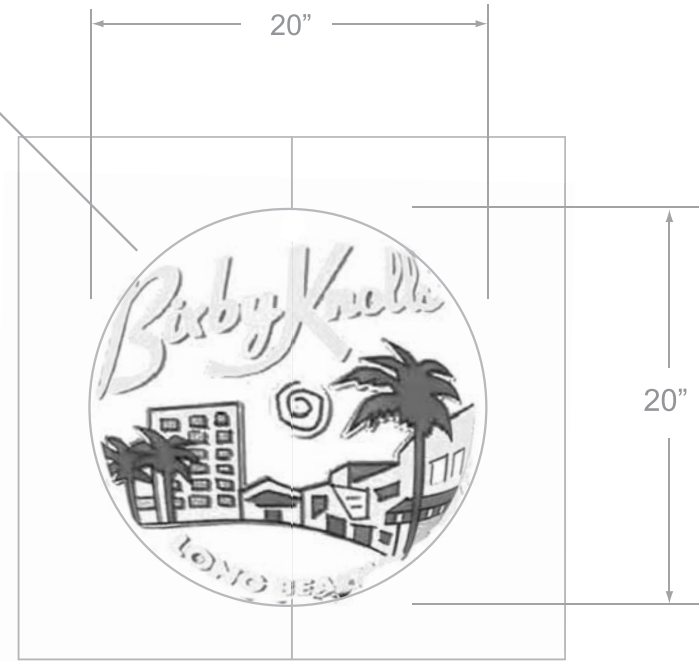

embedded emblem

20" diameter  
Bixby emblem  
stained onto  
sidewalk



stained sidewalk emblem

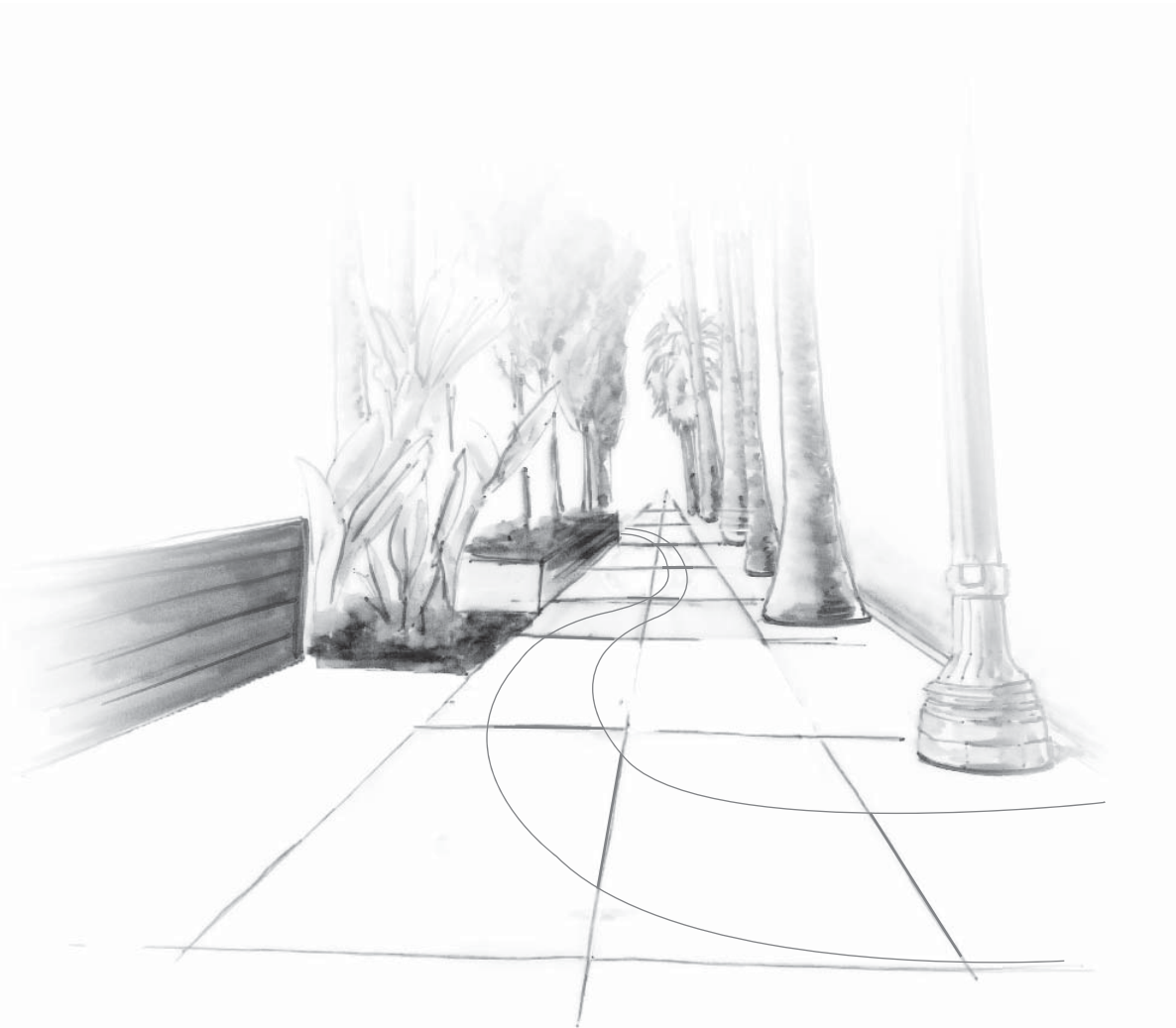

modular mosaic or stained pathway

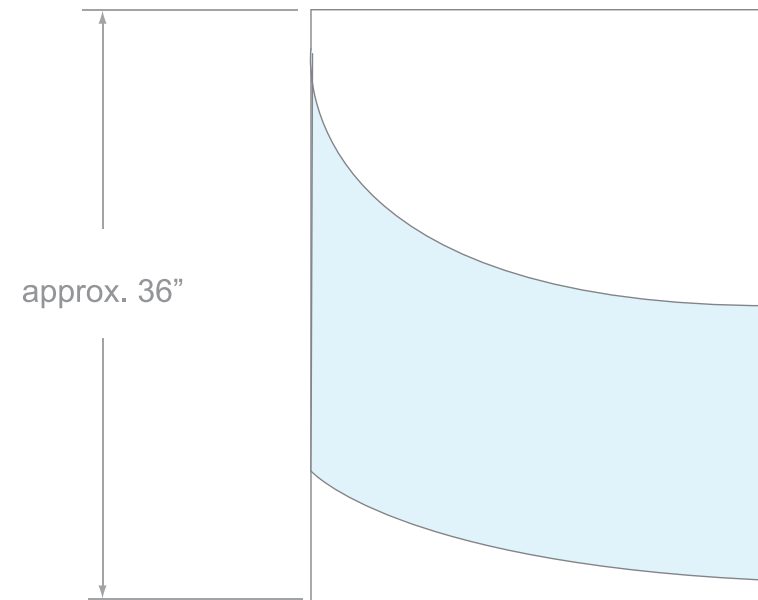



*Bixby Knolls*  
LONG BEACH

Bixby graphic variations



A



B



C



D



E

*Bixby Knolls*  
LONG BEACH

F



G

*Bixby Knolls*  
LONG BEACH



GRENEKER  
SOLUTIONS

*We make cool stuff.*

www.greker.com customerservice@greker.com  
3110 east 12th street los angeles, ca 90023  
P: 323.263.9000 F: 323.263.9543

**G** GRENEKER  
SOLUTIONS

















